

SEA-8603

Single HD/SD Equalizing Amplifier

User Manual

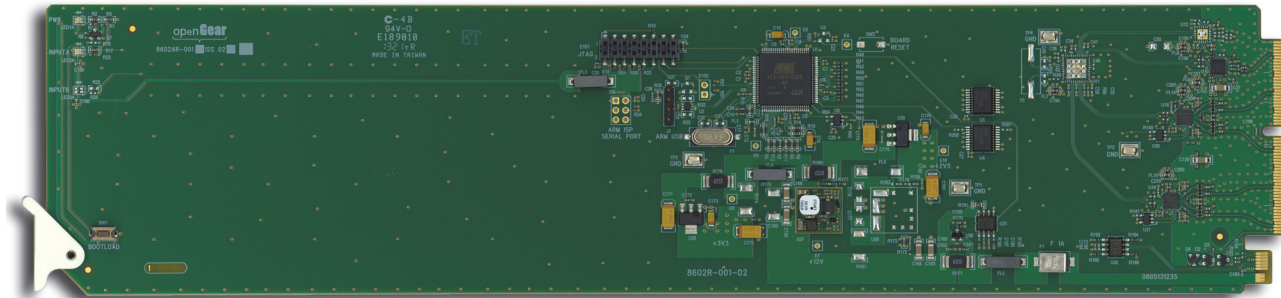

SEA-8603 User Manual

- Ross Part Number: 8603DR-004-01
- Release Date: July 25, 2013.

The information in this manual is subject to change without notice or obligation.

Copyright

© 2013 Ross Video Limited. All rights reserved.

This work is proprietary and confidential to Ross Video Limited, its subsidiaries and its other affiliated corporations and may not be copied, distributed, sold or otherwise used or relied upon without the express written permission of Ross Video Limited. Reproduction or reverse engineering of copyrighted software is prohibited.

Patents

This product is protected by the following US Patents: 4,205,346; 5,115,314; 5,280,346; 5,561,404; 7,304,886; 7,508,455; 7,602,446; 7,834,886; 7,914,332. This product is protected by the following Canadian Patents: 2039277; 1237518; 1127289. Other patents pending.

Notice

The material in this manual is furnished for informational use only. It is subject to change without notice and should not be construed as commitment by Ross Video Limited. Ross Video Limited assumes no responsibility or liability for errors or inaccuracies that may appear in this manual.

Trademarks



-  is a registered trademark of Ross Video Limited.
- Ross, ROSS, ROSS®, and MLE are registered trademarks of Ross Video Limited.
- openGear® is a registered trademark of Ross Video Limited.
- DashBoard Control System™ is a trademark of Ross Video Limited.
- All other product names and any registered and unregistered trademarks mentioned in this manual are used for identification purposes only and remain the exclusive property of their respective owners.

Important Regulatory and Safety Notices to Service Personnel

Before using this product and any associated equipment, refer to the “**Important Safety Instructions**” listed below to avoid personnel injury and to prevent product damage.

Product may require specific equipment, and/or installation procedures to be carried out to satisfy certain regulatory compliance requirements. Notices have been included in this publication to call attention to these specific requirements.

Symbol Meanings



This symbol on the equipment refers you to important operating and maintenance (servicing) instructions within the Product Manual Documentation. Failure to heed this information may present a major risk of damage to persons or equipment.



Warning — The symbol with the word “**Warning**” within the equipment manual indicates a potentially hazardous situation, which, if not avoided, could result in death or serious injury.



Caution — The symbol with the word “**Caution**” within the equipment manual indicates a potentially hazardous situation, which, if not avoided, may result in minor or moderate injury. It may also be used to alert against unsafe practices.



Notice — The symbol with the word “**Notice**” within the equipment manual indicates a potentially hazardous situation, which, if not avoided, may result in major or minor equipment damage or a situation which could place the equipment in a non-compliant operating state.



ESD Susceptibility — This symbol is used to alert the user that an electrical or electronic device or assembly is susceptible to damage from an ESD event.

Important Safety Instructions



Caution — This product is intended to be a component product of the DFR-8321 and OG3-FR series frames. Refer to the DFR-8300 and OG3-FR Series Frame User Manual for important safety instructions regarding the proper installation and safe operation of the frame as well as its component products.



Warning — Certain parts of this equipment namely the power supply area still present a safety hazard, with the power switch in the OFF position. To avoid electrical shock, disconnect all A/C power cords from the chassis’ rear appliance connectors before servicing this area.



Warning — Service barriers within this product are intended to protect the operator and service personnel from hazardous voltages. For continued safety, replace all barriers after any servicing.

This product contains safety critical parts, which if incorrectly replaced may present a risk of fire or electrical shock. Components contained within the product’s power supplies and power supply area, are not intended to be customer serviced and should be returned to the factory for repair. To reduce the risk of fire, replacement fuses must be the same time and rating. Only use attachments/accessories specified by the manufacturer.

EMC Notices

United States of America FCC Part 15

This equipment has been tested and found to comply with the limits for a class A Digital device, pursuant to part 15 of the FCC Rules. These limits are designed to provide reasonable protection against harmful interference when the equipment is operated in a commercial environment. This equipment generates, uses, and can radiate radio frequency energy and, if not installed and used in accordance with the instruction manual, may cause harmful interference to radio communications. Operation of this equipment in a residential area is likely to cause harmful interference in which case the user will be required to correct the interference at their own expense.



Notice — *Changes or modifications to this equipment not expressly approved by Ross Video Limited could void the user's authority to operate this equipment.*

CANADA

This Class "A" digital apparatus complies with Canadian ICES-003.

Cet appareil numérique de la classe "A" est conforme à la norme NMB-003 du Canada.

EUROPE

This equipment is in compliance with the essential requirements and other relevant provisions of CE Directive 93/68/EEC.

INTERNATIONAL

This equipment has been tested to **CISPR 22:1997** along with amendments **A1:2000** and **A2:2002**, and found to comply with the limits for a Class A Digital device.



Notice — *This is a Class A product. In domestic environments, this product may cause radio interference, in which case the user may have to take adequate measures.*

Maintenance/User Serviceable Parts

Routine maintenance to this openGear product is not required. This product contains no user serviceable parts. If the module does not appear to be working properly, please contact Technical Support using the numbers listed under the "Contact Us" section on the last page of this manual. All openGear products are covered by a generous 5-year warranty and will be repaired without charge for materials or labor within this period. See the "Warranty and Repair Policy" section in this manual for details.

Environmental Information

The equipment that you purchased required the extraction and use of natural resources for its production. It may contain hazardous substances that could impact health and the environment.

To avoid the potential release of those substances into the environment and to diminish the need for the extraction of natural resources, Ross Video encourages you to use the appropriate take-back systems. These systems will reuse or recycle most of the materials from your end-of-life equipment in an environmentally friendly and health conscious manner.

The crossed out wheelie bin symbol invites you to use these systems.



If you need more information on the collection, re-use, and recycling systems, please contact your local or regional waste administration.

You can also contact Ross Video for more information on the environmental performance of our products.

Company Address



Ross Video Limited

8 John Street
Iroquois, Ontario, K0E 1K0
Canada

Ross Video Incorporated

P.O. Box 880
Ogdensburg, New York
USA 13669-0880

General Business Office: (+1) 613 • 652 • 4886

Fax: (+1) 613 • 652 • 4425

Technical Support: (+1) 613 • 652 • 4886

After Hours Emergency: (+1) 613 • 349 • 0006

E-mail (Technical Support): techsupport@rossvideo.com

E-mail (General Information): solutions@rossvideo.com

Website: <http://www.rossvideo.com>

Contents

- Introduction 1**
 - Overview..... 1-2
 - Features..... 1-2
 - Functional Block Diagrams 1-3
 - Single 1x8 Configurations..... 1-3
 - Single 1x4 Configuration 1-3
 - User Interfaces 1-4
 - DashBoard Control System™ 1-4
 - Card-edge Monitoring 1-4
 - SNMP Monitoring and Control 1-4
 - Documentation Terms and Conventions..... 1-5

- Installation 2**
 - Before You Begin 2-2
 - Static Discharge..... 2-2
 - Unpacking..... 2-2
 - Installing the SEA-8603..... 2-3
 - Supported Rear Modules 2-3
 - Installing a Card 2-3
 - Cabling..... 2-5
 - Software Upgrades..... 2-7

- Configuration 3**
 - Card Overview 3-2
 - Monitoring Features..... 3-3
 - Status LEDs 3-3
 - Using DashBoard..... 3-4
 - Configuring the SEA-8603 3-5
 - Configuring the Equalizer 3-5
 - Loss of Input..... 3-5

- DashBoard Menus 4**
 - Status Tabs 4-2
 - Signal Tab..... 4-2
 - Hardware Tab 4-3
 - Product Tab 4-3
 - Setup Tab 4-4
 - Alarms Tab 4-5

- Specifications 5**
 - Technical Specifications 5-2

Service Information

6

Troubleshooting Checklist	6-2
Bootload Button	6-2
Warranty and Repair Policy	6-3

Introduction

In This Chapter

This chapter contains the following sections:

- Overview
- Functional Block Diagrams
- User Interfaces
- Documentation Terms and Conventions

A Word of Thanks

Congratulations on choosing an openGear SEA-8603 HD/SD Equalizing Amplifier. Your SEA-8603 is part of a full line of Digital Products within the openGear Terminal Equipment family of products, backed by Ross Video's experience in engineering and design expertise since 1974.

You will be pleased at how easily your new card fits into your overall working environment. Equally pleasing is the product quality, reliability and functionality. Thank you for joining the group of worldwide satisfied Ross Video customers!

Should you have a question pertaining to the installation or operation of your card, please contact us at the numbers listed on the back cover of this manual. Our technical support staff is always available for consultation, training, or service.

Overview

Your SEA-8603 is a Multi-Definition SDI distribution amplifier, capable of equalizing and reclocking all common serial digital signals. Each channel of your SEA-8603 equalizes the incoming SDI signal, compensating for greater than 400m of cable at 270MHz, and greater than 150m of cable at 1.485GHz. An LED indicator at the front of the card identifies the presence of incoming video simplifying system troubleshooting.

Each SEA-8603 is capable of equalizing all common serial digital signals. Support for HD, and SD signals makes our equalizing amplifiers an extremely versatile SDI distribution amplifier. Special attention has been taken to ensure the SDI outputs faithfully reproduce the incoming signals, with excellent jitter and return loss specifications.

Features

The SEA-8603 includes the following features:

- Equalizes SDI signals of 270Mbps, and 1.485Gbps
- Equalizes up to 400m of cable at 270Hz, and greater than 150m of cable at 1.485GHz
- Accepts DVB-ASI and SMPTE 310 signals
- Flexible channel configurations:
 - › Operate as single 1x8 (*requires the 8320AR-300 or 8320AR-302 Full Rear Modules*)
 - › Operate as single 1x4 (*requires the 8320AR-301 Split Rear Module*)
- Configure and monitor via the DashBoard Control System™
- Automatic detection of incoming data rate
- Automatically mutes the channel output when a loss of input occurs
- LED indicator for signal presence
- Excellent input and output return loss
- Fits DFR-8321 and OG3-FR series frames
- Fully compliant with openGear specifications
- 5 year transferable warranty

Functional Block Diagrams

The SEA-8603 can operate as an equalizing single 1x8 or as a single 1x4. The configuration depends on the rear module you are using. This section provides the block diagrams for both configurations.

Single 1x8 Configurations

Figure 1.1 describes the workflow of the SEA-8603 with the 8320AR-300 Full Rear module. This configuration has the SEA-8603 operating as a single equalizing 1x8 with BNC connections.

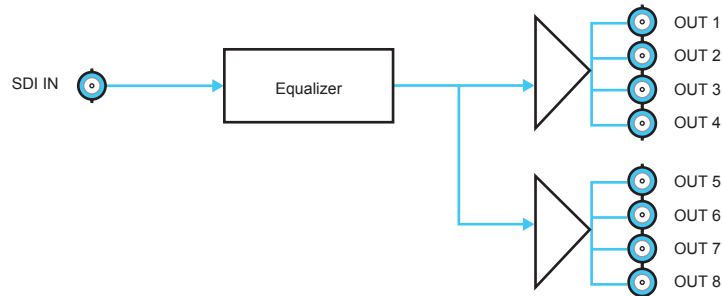

Figure 1.1 Simplified Diagram — 1x8 Configuration (8320AR-300)

Figure 1.2 describes the workflow of the SEA-8603 with the 8320AR-302 Full Rear module. This configuration has the SEA-8603 operating as a single equalizing 1x8 but with HD-BNC connections.

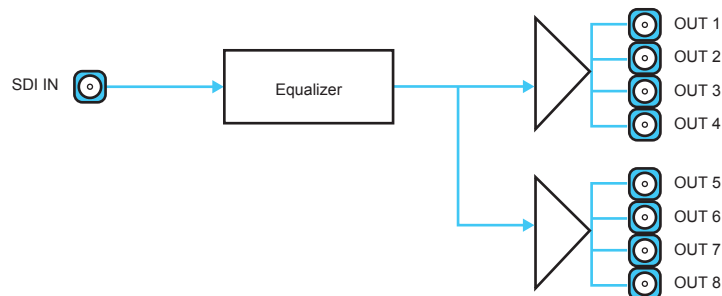

Figure 1.2 Simplified Diagram — 1x8 Configuration (8320AR-302)

Single 1x4 Configuration

Figure 1.3 describes the workflow of the SEA-8603 with the 8320AR-301 Split Rear module. This configuration has the SEA-8603 operating as a single equalizing 1x4 with BNC connections.

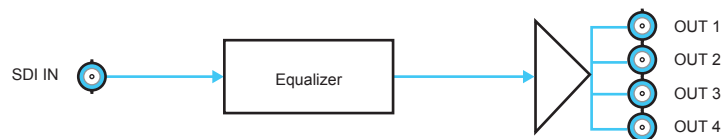

Figure 1.3 Simplified Diagram — 1x4 Configuration (8320AR-301)

User Interfaces

The following interfaces are available for control and monitoring of your SEA-8603.

DashBoard Control System™

The DashBoard Control System™ enables you to monitor and control openGear frames and cards from a computer. DashBoard communicates with other cards in the openGear frame through the Network Controller Card.

For More Information on...

- menus in DashBoard, refer to the section “**DashBoard Menus**” on page 4-1.
- installing and using DashBoard, refer to the *DashBoard User Manual*.

Card-edge Monitoring

The card-edges provide LEDs for monitoring the status of the input signal.

For More Information on...

- card-edge LEDs, refer to the section “**Monitoring Features**” on page 3-3.

SNMP Monitoring and Control

The Network Controller card in the openGear frame provides optional support for remote monitoring and control of your frame and openGear cards using Simple Network Management Protocol (SNMP), which is compatible with many third-party monitoring and control tools.

For More Information on...

- SNMP controls on your card, refer to your SEA-8603 Management Information Base (MIB) file.
- SNMP Monitoring and Control, refer to your *MFC-8300 Series User Manual*.

Documentation Terms and Conventions

The following terms and conventions are used throughout this manual.

Terms

The following terms are used:

- “**Board**” and “**Card**” both refer to the card, including all components and switches.
- “**DashBoard**” refers to the DashBoard Control System™.
- “**DFR-8321 series**” refers to the DFR-8321 series frames and all available options unless otherwise indicated.
- “**openGear frame**” refers to all versions of the DFR-8321 series and OG3-FR series frames unless otherwise indicated.
- “**OG3-FR series**” refers to the OG3-FR series frames and all available options unless otherwise indicated.
- “**Operator**” and “**User**” both refer to the person who uses the SEA-8603.
- “**System**” and “**Video system**” both refer to the mix of interconnected production and terminal equipment in which the card operates.

Conventions

The following conventions are used:

- The “**Operating Tips**” and “**Note**” boxes are used to provide additional user information.

Installation

In This Chapter

This chapter provides instructions for installing the rear module for your SEA-8603, installing the card in the frame, cabling details, and how to upgrade the software on your card(s).

The following topics are discussed:

- Before You Begin
- Installing the SEA-8603
- Cabling
- Software Upgrades

Before You Begin

Before proceeding with the instructions in this chapter, ensure that your openGear frame is properly installed according to the instructions in the *DFR-8300 and OG3-FR Series User Manual*.

Static Discharge

Throughout this chapter, please heed the following cautionary note:



ESD Susceptibility — *Static discharge can cause serious damage to sensitive semiconductor devices. Avoid handling circuit boards in high static environments such as carpeted areas and when synthetic fiber clothing is worn. Always exercise proper grounding precautions when working on circuit boards and related equipment.*

Unpacking

Unpack each card you received from the shipping container and ensure that all items are included. If any items are missing or damaged, contact your sales representative or Ross Video directly.

Installing the SEA-8603

The procedure for installing the rear module and card in your openGear frame is the same regardless of the rear module used. The SEA-8603 can be installed in the DFR-8321 series frames and the OG3-FR series frames using one of the supported rear modules.

Supported Rear Modules



Notice — Ensure that you install the SEA-8603 using one of the supported rear modules listed below. Installing the SEA-8603 with an unsupported rear module can damage the card, the rear module, or both.

The Rear Module depends on the configuration you wish to use:

- **1x8 configuration** — The **8320AR-300** or **8320AR-302** Full Rear Module is required.
- **1x4 configuration** — The **8320AR-301** Split Rear Module is required.

Installing a Card

You must first install the rear module in the frame and then install the card in the appropriate slot within an openGear frame. This section outlines how to perform both tasks.

To install the rear module in the openGear frame

1. Refer to the *DFR-8300 and OG3-FR Series User Manual* to ensure that the openGear frame is properly installed.
2. On the rear of the openGear frame, locate the card frame slot.
3. Remove the Blank Plate from the rear of the slot you have chosen for card installation.
4. As shown in **Figure 2.1**, seat the bottom of the rear module in the seating slot at the base of the frame's back plane.

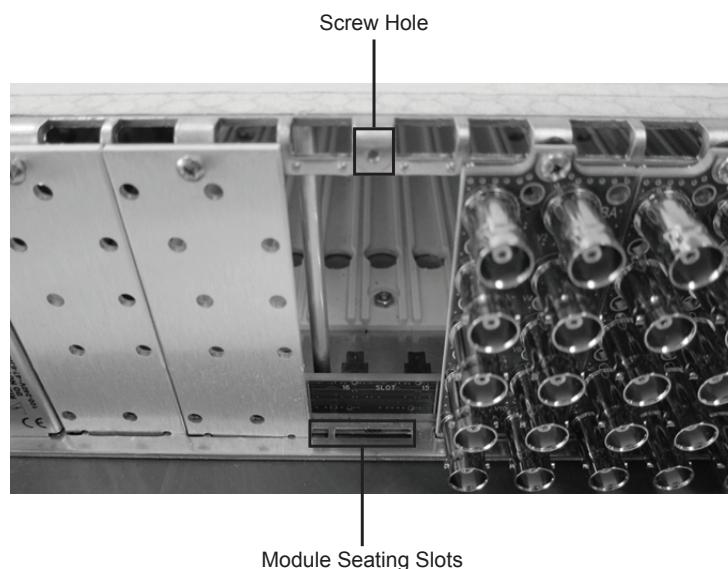

Figure 2.1 Rear Module Installation in an OG3-FR Series Frame (Cards not shown)

5. Align the top hole of the rear module with the screw hole on the top edge of the frame back plane.
6. Using a Phillips screwdriver and the supplied screw, fasten the rear module to the back plane. Do not over-tighten.
7. Verify whether your Rear Module Label is self-adhesive by checking the back of the label for a thin wax sheet. You must remove the wax sheet before affixing the label.
8. Affix the supplied Rear Module Label to the BNC area of the Rear Module.
9. Ensure proper frame cooling and ventilation by having all rear frame slots covered with rear modules or blank metal plates.

To install the card in the openGear frame

1. Locate the Rear Module you installed in the procedure “**To install the rear module in the openGear frame**” on page 2-3.
2. Hold the card by the edges and carefully align the card edges with the slots in the frame.
3. Fully insert the card into the frame until the rear connection plugs are properly seated on the midplane and rear modules.

Cabling

The SEA-8603 can operate as a single 1x8, or as a single 1x4 depending on the rear module you are using. This section provides cabling details for supported configurations.



Important — *It is necessary to terminate unused outputs.*

Single 1x8 Configurations

The following rear modules can be used when operating as a single 1x8 configuration:

- 8320AR-300 Full Rear Module — Each rear module occupies two slots and accommodates one card. This rear module provides an SDI input, and eight SDI outputs via BNC connections. (**Figure 2.2**)
- 8320AR-302 Full Rear Module — Each rear module occupies two slots and accommodates one card. This rear module provides an SDI input, and eight SDI outputs via HD-BNC connections. (**Figure 2.3**)

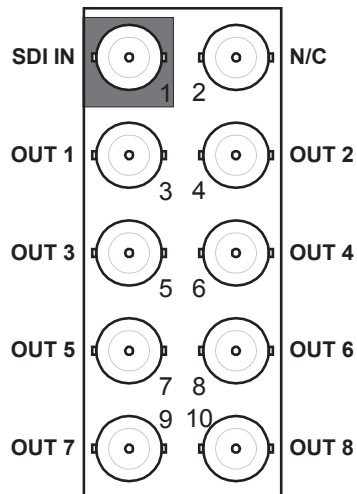

Figure 2.2 Cable Connections for the 8320AR-300 Full Rear Module

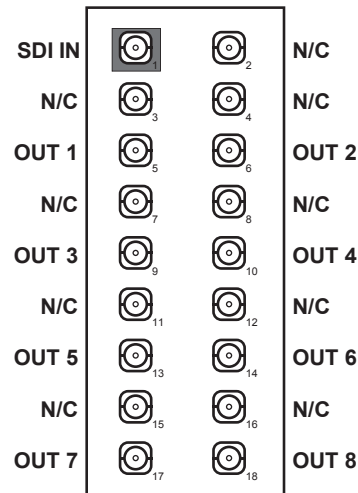

Figure 2.3 Cable Connections for the 8320AR-302 Full Rear Module

Single 1x4 Configuration

The 8320AR-301 Split Rear Module is required when operating as a single 1x4 configuration. This rear module occupies two slots, and accommodates two cards. This rear module provides one SDI input, and four SDI outputs via BNC connections per card. (**Figure 2.4**)

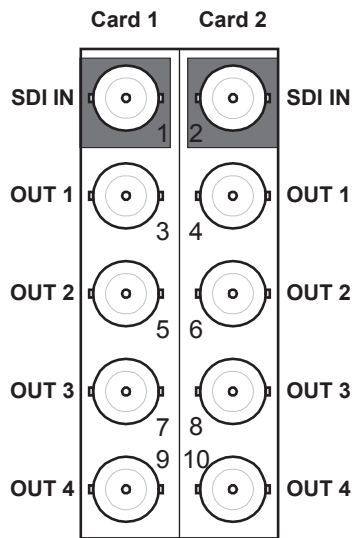

Figure 2.4 Cable Connections for the 8320AR-301 Split Rear Module

Software Upgrades

The card can be upgraded in the field via the MFC-8300 series Network Controller card in your frame. Note that DashBoard version 5.1.0 or higher is required for this procedure.

To upgrade the software on a card

1. Contact Ross Technical Support for the latest software version file.
2. Display the **Device View** of the card by double-clicking its status indicator in the **Basic Tree View**.
3. From the **Device View**, click **Upload** to display the **Select file for upload** dialog.
4. Navigate to the *.bin upload file you wish to upload.
5. Click **Open**.
6. If you are upgrading a single card, click **Finish** to display the **Uploading to Selected Devices** dialog. Proceed to step 8.
7. If you are upgrading multiple cards:
 - Click **Next >** to display the **Select Destination** menu. This menu provides a list of the compatible cards based on the card selected in step 2.
 - Specify the card(s) to upload the file to by selecting the check box(es) for the cards you wish to upload the file to.
 - Verify that the card(s) you wish to upload the file to. The **Error/Warning** fields indicate any errors, such as incompatible software or card type mismatch.
 - Click **Finish** to display the **Uploading to Selected Devices** dialog.
8. Monitor the upgrade.
 - The **Uploading to Selected Devices** dialog enables you to monitor the upgrade process.
 - Click **OK** to complete the upgrade.
 - The card(s) are temporarily taken offline during the re-boot process. The process is complete once the status indicators for the **Card State** and **Connection** fields return to their previous status.

Configuration

In This Chapter

This chapter provides a general overview of the user controls available on your SEA-8603.

The following topics are discussed:

- Card Overview
- Monitoring Features
- Using DashBoard
- Configuring the SEA-8603

Card Overview

This section describes the **Bootload** button located on each card surface. There are no other card-edge controls as all configuration and setup is done using the menus in DashBoard. Refer to **Figure 3.1** for location of this button.

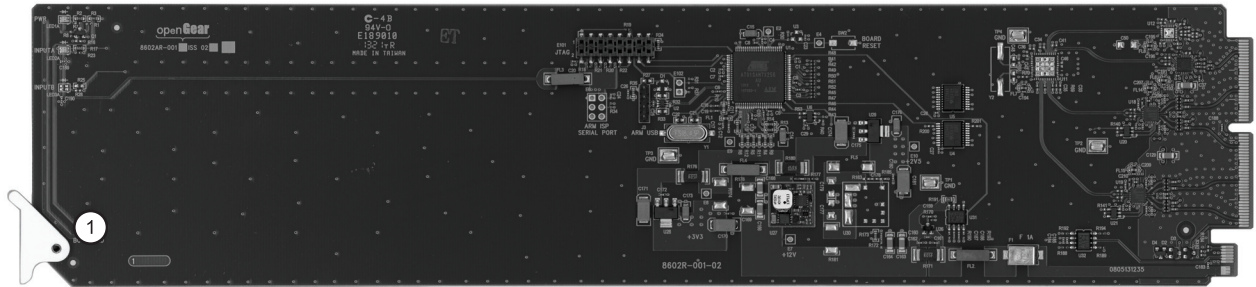

Figure 3.1 Card-edge Controls

1. **Bootload Button**

This button is used for factory service in the unlikely event of a complete card failure. Do not use this button unless advised by Ross Technical Support.

For More Information on...

- the Bootload process, refer to the section “**Bootload Button**” on page 6-2.

Monitoring Features

The following sections describe the card-edge LEDs. Refer to **Figure 3.2** for LED locations.

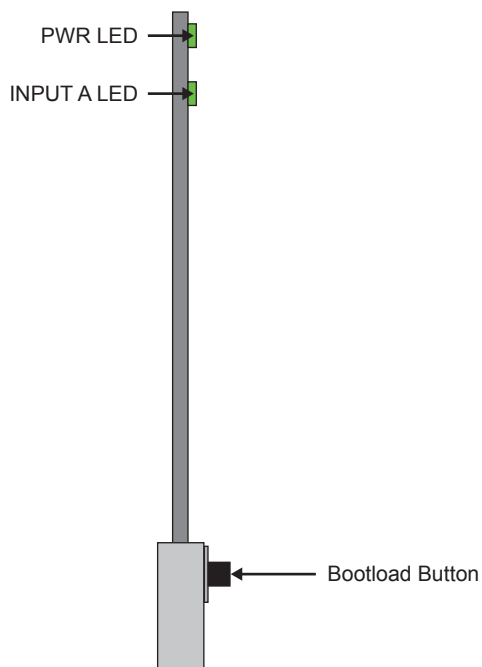

Figure 3.2 LED Locations

Status LEDs

Basic LED displays and descriptions are provided in **Table 3.1**.

Table 3.1 Status LEDs

LED	Color	Display and Description
PWR	Green	When lit green, this LED indicates that the card is functioning normal and that no anomalies have been detected.
	Flashing Green	When flashing green, this LED indicates that the Bootload button was pressed, and the card is receiving a new software load from the frame.
	Flashing Green and Orange	When lit green with flashing orange, this LED indicates a signal or configuration problem. Verify the signal status and settings.
	Amber	When lit amber, this LED indicates the card is running internal diagnostics while powering up.
	Red	When lit red or flashing red, this LED indicates the card is not operational. Re-seat card in frame, check the rear module type and connections, or call Ross Video Technical Support.
	Off	When off, this LED indicates there is no power to the card.
INPUT A	Green	When lit green, this LED indicates that a valid SDI input signal is present on Channel A.
	Red	When lit red, this LED indicates that the SDI input signal is missing or invalid on Channel A.
INPUT B	This LED is not implemented.	

Using DashBoard

Before proceeding, ensure that the DashBoard Control System™ is installed on a PC connected to your facility network. The DashBoard software and user manual are available from the Ross Video website.

For More Information on...

- installing DashBoard, refer to the *DashBoard User Manual*.

To launch DashBoard

1. Ensure that you are running DashBoard software version 5.1.0 or higher.
2. Launch DashBoard by double-clicking its icon on your desktop.
3. Ensure that the openGear frame with your SEA-8603 card(s) is displayed in the Tree View located on the left-side of the DashBoard window.

It may take 30 seconds or more to update the Tree View. Consult the *MFC-8300 Series User Manual* and *DashBoard User Manual* should the Tree View not display the card.

To access a card in DashBoard

1. From the **Tree View**, expand the node for the openGear frame your cards are installed in. A list of cards installed in the frame is now displayed. In the example below, the node for Frame 6 is expanded to show a list of cards including the SEA-8603.
2. Double-click the node for a card to display its menus in the **Device View** of DashBoard (right-side of the DashBoard window).

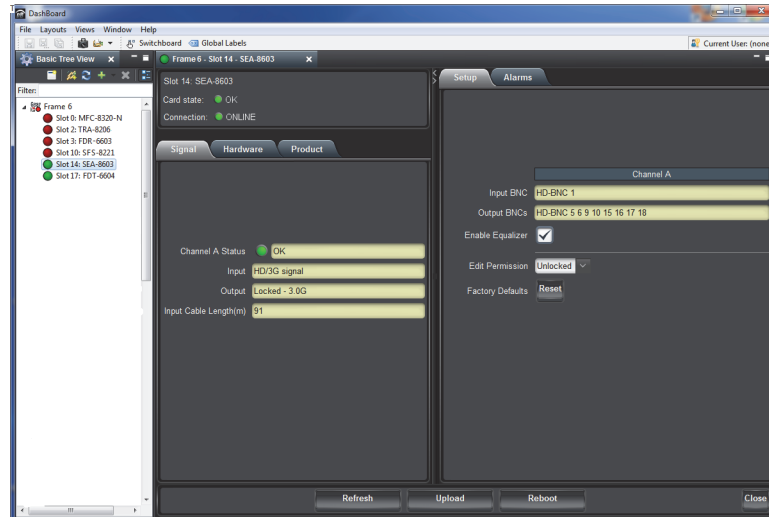

Example of a SEA-8603 in DashBoard

Configuring the SEA-8603

This section briefly outlines how to configure the SEA-8603 using the options available in DashBoard.

Configuring the Equalizer

This section summarizes how to set up the equalizer.

To enable the equalizer

1. From the **Device View**, select the **Setup** tab.

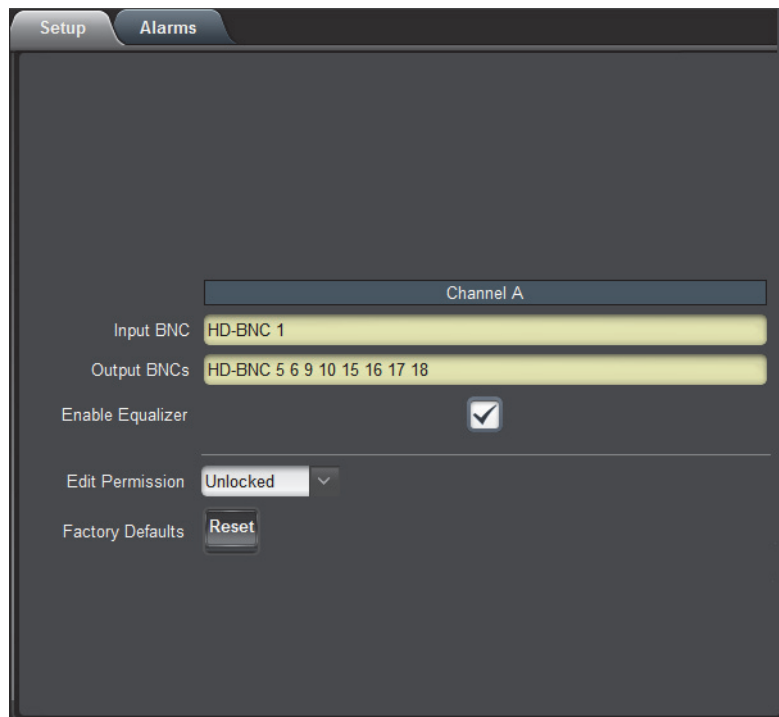

Setup Tab — Enabling the Equalizer

2. Select the **Enable Equalizer** check box. The box displays a check-mark.

To bypass the equalizer

1. From the **Device View**, select the **Setup** tab.
2. Select the **Enable Equalizer** check box to clear the box contents.

Loss of Input

You can configure the SEA-8603 to raise an alarm when a loss of input occurs.

To enable an alarm for a loss of input

1. From the **Device View**, select the **Alarms** tab.
2. Select the **Alarm on Loss of Input** check box. The box displays a check-mark.

The **Status** field in the **Signal** tab now reports when the card detects an invalid or absent input signal. To verify which BNC to troubleshoot, refer to the rear module labelling or the **Input BNC** field in the **Setup** tab.

DashBoard Menus

In This Chapter

This chapter briefly summarizes the menus, items, and parameters available from DashBoard for your card. Default parameters are noted with an asterisk (*).

The following topics are discussed:

- Status Tabs
- Setup Tab
- Alarms Tab

Status Tabs

This section summarizes the read-only information displayed in the **Status** tabs. The fields in the **Signal** tab vary in severity from green (valid), yellow (caution), to red (alarm). DashBoard reports the most severe alarm for a single field. Alarm colors are noted within the tables as text set in brackets next to the menu parameter name.

Signal Tab

Table 4.1 outlines the read-only information displayed in the **Signal** tab.

Table 4.1 Signal Tab Items

Tab Title	Item	Parameters	Description
Channel A	Channel A Status	OK (Green)	A valid input signal is detected
		No input (Red)	Input signal is not present. The Alarm on Loss of Input for this channel is enabled.
		No input (Green)	Input signal is not present. The Alarm of Loss of Input for this channel is disabled.
	Input	No signal	Input signal is not present
		SD signal	A valid SD input signal is present
		HD/3G signal	A valid HD or 3G input signal is present
		Equalizer bypassed	Input signal is present and the equalizer is bypassed (the Enable Equalizer check box is not selected in the Setup tab)
	Output	Signal present	Input signal is present and valid
		No signal (muted)	Input signal is not present
	Input Cable Length (m)	x (1694A) / y (1855A)	Indicates the approximate cable length used for the input signal where: <ul style="list-style-type: none"> • x represents the Belden 1694A length • y represents the Belden 1855A length
		N/A	A valid input source was not detected on the input BNC

Hardware Tab

Table 4.2 outlines the read-only information displayed in the **Hardware** tab.

Table 4.2 Hardware Tab Items

Tab Title	Item	Parameters	Description
Hardware	HW Status	OK (Green)	The rear module installed with the card is supported and the card is operating correctly
		Wrong Board Type (Red)	Board type on flash does not match the board type resistor
		Incomp Rear Module (Red)	An unsupported rear module is installed with the card
	Voltage (mV)	#	Supply Voltage
	Current (mA)	#	Current consumption of card
	CPU Headroom	#	Processing power available
	RAM Available	#	On-board processing memory available
	Uptime (h)	#	Displays the number of hours since the last reboot of the card
Configuration Bank	#	Storage count	

Product Tab

Table 4.3 outlines the read-only information displayed in the **Product** tab.

Table 4.3 Product Tab Items

Tab Title	Item	Parameters	Description
Product	Product	SEA-8603	Displays the card model
	Supplier	Ross Video Ltd.	Indicates the manufacturer of your card
	Board Rev	##	Indicates the version of the PCB
	Board S/N	#####	Indicates the card serial number
	Rear Module	#	Indicates the rear module the card is installed in
		Unknown	Indicates that the installed rear module is not recognized by the card
	Software Rev	##.##	Indicates the software version

Setup Tab

Table 4.4 summarizes the Setup options available in DashBoard.

Table 4.4 Setup Menu Items

Menu Title	Item	Parameters	Description
Channel A	Input BNC	# (read-only)	Indicates the BNC on the rear module that is assigned as the input source
		N/C	Indicates that no BNCs are currently used as inputs for the channel
	Output BNCs	# (read-only)	Indicates the BNCs on the rear module that are assigned as the outputs
		N/C	Indicates that there are no outputs in this channel
	Enable Equalizer	Selected*	Equalizer is always enabled
		Cleared	Disables the equalizer and sets the equalizer in bypass mode
	Edit Permission	Unlocked*	All configurable menu options are editable
		Locked	All configurable menu options, except this one, are locked and are read-only
	Factory Defaults	Reset	Resets all editable parameters to the factory default values

Alarms Tab

Table 4.5 summarizes the **Alarms** options available in DashBoard.

Table 4.5 Alarm Enables Menu Items

Menu Title	Item	Parameters	Description
Channel A	Alarm on Loss of Input	Selected*	The Status field in the Signal tab reports the loss of the input as an error/alarm
		Cleared	The Status field in the Signal tab reports the loss of the input as information only (status indicator does not update)

Specifications

In This Chapter

This chapter includes the technical specifications for the SEA-8603. Note that specifications are subject to change without notice.

The following topics are discussed:

- Technical Specifications

Technical Specifications

This section lists the technical specifications for the SEA-8603.

Table 5.1 Technical Specifications

Category	Parameter	Specification
Rear Modules	Supported Rear Modules	8320AR-300, 8320AR-301, and 8320AR-302
SDI Inputs	Number of Inputs	8320AR-300 Full Rear Module: 2 8320AR-301 Split Rear Module:1 8320AR-302 Full Rear Module:2
	Data Rates and SMPTE Standards Accommodated	143Mbps, NTSC AFSC, SMPTE 259M 270Mbps, 525/625 Component, SMPTE 259M 270Mbps, SMPTE 310 270Mbps, DVB-ASI 1.485Gbps Component, SMPTE 292M
	Impedance	75Ω terminating
	Equalization	>400m (1300ft) of Belden 1694A cable @ 270MHz >150m (490ft) of Belden 1694A cable @ 1.485MHz
		>225m (740ft) of Belden 1855A cable @ 270MHz >100m (325ft) of Belden 1855A cable @ 1.485MHz
	Return Loss	>15dB to 3GHz
Connector Type	8320AR-300, 8320AR-301: BNC 8320AR-302: HD-BNC	
SDI Outputs	Number of Outputs	8320AR-300 Full Rear Module:8 8320AR-301 Split Rear Module:4 8320AR-302 Full Rear Module:17
	Impedance	75Ω
	Return Loss	>15dB to 1.485GHz
	Signal Level	800mV ±10%
	DC Offset	0V ±50mV
	Rise & Fall Time (20-80%)	700ps typical (270Mbps) 120ps typical (1.485Gbps)
	Overshoot	<10%
Connector Type	8320AR-300, 8320AR-301: BNC 8320AR-302: HD-BNC	
Environment	Maximum Ambient Temperature	40°C (104°F)
Power	Total Power Consumption	1.8W

Service Information

In This Chapter

This chapter contains the following sections:

- Troubleshooting Checklist
- Warranty and Repair Policy

Troubleshooting Checklist

Routine maintenance to this openGear product is not required. In the event of problems with your card, the following basic troubleshooting checklist may help identify the source of the problem. If the frame still does not appear to be working properly after checking all possible causes, please contact your openGear products distributor, or the Technical Support department at the numbers listed under the “**Contact Us**” section at the end of the manual.

1. **Visual Review** — Performing a quick visual check may reveal many problems, such as connectors not properly seated or loose cables. Check the card, the frame, and any associated peripheral equipment for signs of trouble.
2. **Power Check** — Check the power indicator LED on the distribution frame front panel for the presence of power. If the power LED is not illuminated, verify that the power cable is connected to a power source and that power is available at the power main. Confirm that the power supplies are fully seated in their slots. If the power LED is still not illuminated, replace the power supply with one that is verified to work.
3. **Input Signal Status** — Verify that source equipment is operating correctly and that a valid signal is being supplied.
4. **Output Signal Path** — Verify that destination equipment is operating correctly and receiving a valid signal.
5. **Card Exchange** — Exchanging a suspect card with a card that is known to be working correctly is an efficient method for localizing problems to individual cards.

Bootload Button

In the unlikely event of a complete card failure, you may be instructed by a Ross Technical Support specialist to perform a complete software reload on the card.

To perform a complete software reload on the card

1. Eject the card.
2. Press and hold the **Bootload** button, while re-inserting the card into the frame.
3. Release the button. The **PWR** LED flashes green while the card is waiting for a new software load.
 - If a new software load is not sent to the card within 60 seconds, the card will attempt to restart with its last operational software load.
 - Contact Ross Technical Support for the latest software load for your card.

Warranty and Repair Policy

The SEA-8603 is warranted to be free of any defect with respect to performance, quality, reliability, and workmanship for a period of FIVE (5) years from the date of shipment from our factory. In the event that your SEA-8603 proves to be defective in any way during this warranty period, Ross Video Limited reserves the right to repair or replace this piece of equipment with a unit of equal or superior performance characteristics.

Should you find that this SEA-8603 has failed after your warranty period has expired, we will repair your defective product should suitable replacement components be available. You, the owner, will bear any labor and/or part costs incurred in the repair or refurbishment of said equipment beyond the FIVE (5) year warranty period.

In no event shall Ross Video Limited be liable for direct, indirect, special, incidental, or consequential damages (including loss of profits) incurred by the use of this product. Implied warranties are expressly limited to the duration of this warranty.

This User Manual provides all pertinent information for the safe installation and operation of your openGear Product. Ross Video policy dictates that all repairs to the SEA-8603 are to be conducted only by an authorized Ross Video Limited factory representative. Therefore, any unauthorized attempt to repair this product, by anyone other than an authorized Ross Video Limited factory representative, will automatically void the warranty. Please contact Ross Video Technical Support for more information.

In Case of Problems

Should any problem arise with your SEA-8603, please contact the Ross Video Technical Support Department. (Contact information is supplied at the end of this publication.)

A Return Material Authorization number (RMA) will be issued to you, as well as specific shipping instructions, should you wish our factory to repair your SEA-8603. If required, a temporary replacement frame will be made available at a nominal charge. Any shipping costs incurred will be the responsibility of you, the customer. All products shipped to you from Ross Video Limited will be shipped collect.

The Ross Video Technical Support Department will continue to provide advice on any product manufactured by Ross Video Limited, beyond the warranty period without charge, for the life of the equipment.

Contact Us

Contact our friendly and professional support representatives for the following:

- Name and address of your local dealer
- Product information and pricing
- Technical support
- Upcoming trade show information

Technical Support

Telephone: +1 613 • 652 • 4886
After Hours Emergency: +1 613 • 349 • 0006
Email: techsupport@rossvideo.com

General Information

Telephone: +1 613 • 652 • 4886
Fax: +1 613 • 652 • 4425
Email: solutions@rossvideo.com
Website: <http://www.rossvideo.com>

Visit Us

Visit our website for:

- Company information and news
- Related products and full product lines
- Online catalog
- Testimonials