

# CMA-8011A

## Component Monitoring Amplifier

### User Manual

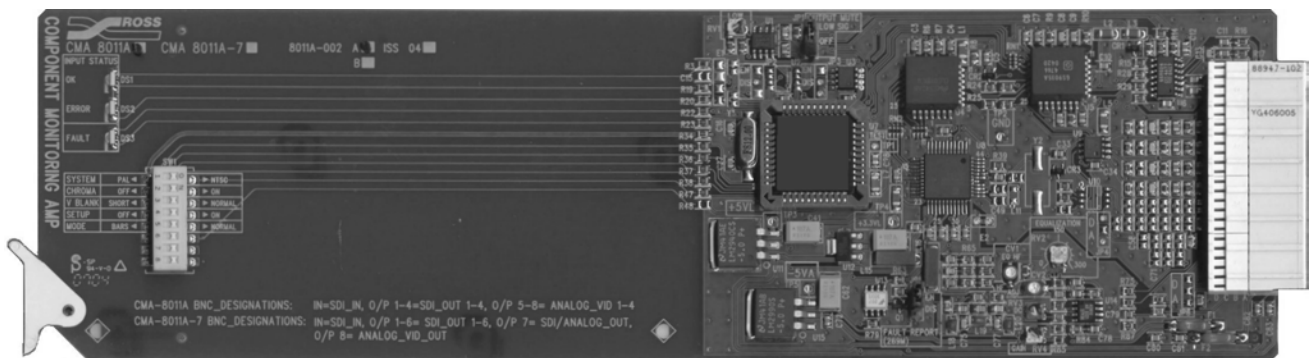

Ross Part Number: 8011ADR-004  
Issue: 05

---

## CMA-8011A • Component Monitoring Amplifier User Manual

- Ross Part Number: **8011ADR-004**
- Document Issue: **05**
- Release Date: November 22, 2005. Printed in Canada.

The information contained in this User Manual is subject to change without notice or obligation.

---

## Copyright

© 2005 Ross Video Limited. All rights reserved.

Contents of this publication may not be reproduced in any form without the written permission of Ross Video Limited. Reproduction or reverse engineering of copyrighted software is prohibited.

---

## Notice

The material in this manual is furnished for informational use only. It is subject to change without notice and should not be construed as a commitment by Ross Video Limited. Ross Video Limited assumes no responsibility or liability for errors or inaccuracies that may appear in this manual.

---

## Trademarks

-  is a registered trademark of Ross Video Limited.
- Ross, ROSS, ROSS®, and MLE are registered trademarks of Ross Video Limited.
- All other product names and any registered and unregistered trademarks mentioned in this manual are used for identification purposes only and remain the exclusive property of their respective owners.

---

## Important Regulatory and Safety Notices

Before using this product and any associated equipment, refer to the “Important Safety Instructions” listed below so as to avoid personnel injury and to prevent product damage.

Products may require specific equipment, and /or installation procedures be carried out to satisfy certain regulatory compliance requirements. Notices have been included in this publication to call attention to these Specific requirements.

### Symbol Meanings



This symbol on the equipment refers you to important operating and maintenance (servicing) instructions within the Product Manual Documentation. Failure to heed this information may present a major risk of damage or injury to persons or equipment.



**Warning**

The symbol with the word “**Warning**” within the equipment manual indicates a potentially hazardous situation, which if not avoided, could result in death or serious injury.



**Caution**

The symbol with the word “**Caution**” within the equipment manual indicates a potentially hazardous situation, which if not avoided, may result in minor or moderate injury. It may also be used to alert against unsafe practices.



**Notice**

The symbol with the word “**Notice**” within the equipment manual indicates a situation, which if not avoided, may result in major or minor equipment damage or a situation which could place the equipment in a non-compliant operating state.



**ESD**

**Susceptibility**

This symbol is used to alert the user that an electrical or electronic device or assembly is susceptible to damage from an ESD event.

### Important Safety Instructions



**Caution**

This product is intended to be a component product of the RossGear 8000 series frame. Refer to the RossGear 8000 series frame User Manual for important safety instructions regarding the proper installation and safe operation of the frame as well as it’s component products.



**Warning**

Certain parts of this equipment namely the power supply area still present a safety hazard, with the power switch in the OFF position. To avoid electrical shock, disconnect all A/C power cords from the chassis' rear appliance connectors before servicing this area.



**Warning**

Service barriers within this product are intended to protect the operator and service personnel from hazardous voltages. For continued safety, replace all barriers after any servicing.

This product contains safety critical parts, which if incorrectly replaced may present a risk of fire or electrical shock. Components contained within the product’s power supplies and power supply area, are not intended to be customer serviced and should be returned to the factory for repair.

To reduce the risk of fire, replacement fuses must be the same type and rating.

Only use attachments/accessories specified by the manufacturer.

## **EMC Notices**

### ***US FCC Part 15***

This equipment has been tested and found to comply with the limits for a class A Digital device, pursuant to part 15 of the FCC Rules. These limits are designed to provide reasonable protection against harmful interference when the equipment is operated in a commercial environment. This equipment generates, uses, and can radiate radio frequency energy and, if not installed and used in accordance with the instruction manual, may cause harmful interference to radio communications. Operation of this equipment in a residential area is likely to cause harmful interference in which case users will be required to correct the interference at their own expense.



#### **Notice**

Changes or modifications to this equipment not expressly approved by Ross Video Ltd. could void the user's authority to operate this equipment.

### ***CANADA***

This Class "A" digital apparatus complies with Canadian ICES-003.

Cet appareil numérique de classe "A" est conforme à la norme NMB-003 du Canada.

### ***EUROPE***

This equipment is in compliance with the essential requirements and other relevant provisions of **CE Directive 93/68/EEC**.

### ***INTERNATIONAL***

This equipment has been tested to **CISPR 22:1997** along with amendments **A1:2000** and **A2:2002** and found to comply with the limits for a Class A Digital device.



#### **Notice**

This is a Class A product. In domestic environments this product may cause radio interference in which case the user may have to take adequate measures.

## **Maintenance/User Serviceable Parts**

Routine maintenance to this RossGear product is not required. This product contains no user serviceable parts. If the module does not appear to be working properly, please contact Technical Support using the numbers listed under the "Contact Us" section on the last page of this manual. All RossGear products are covered by a generous 5-year warranty and will be repaired without charge for materials or labor within this period. See the "Warranty and Repair Policy" section in this manual for details.

## Environmental Information

**The equipment that you purchased required the extraction and use of natural resources for its production. It may contain hazardous substances that could impact health and the environment.**

To avoid the potential release of those substances into the environment and to diminish the need for the extraction of natural resources, Ross Video encourages you to use the appropriate take-back systems. These systems will reuse or recycle most of the materials from your end-of-life equipment in an environmentally friendly and health conscious manner.

The crossed-out wheeled bin symbol invites you to use these systems.

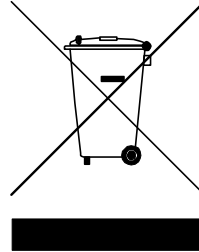

If you need more information on the collection, reuse, and recycling systems, please contact your local or regional waste administration.

You can also contact Ross Video for more information on the environmental performances of our products.





# Contents

<b>Introduction</b>	<b>1-1</b>
In This Chapter .....	1-1
A Word of Thanks .....	1-1
Overview .....	1-2
Functional Block Diagram .....	1-2
Features .....	1-3
Documentation Terms .....	1-3
<b>Installation and Setup</b>	<b>2-1</b>
In This Chapter .....	2-1
Static Discharge .....	2-1
Unpacking .....	2-1
Analog Output Setup Switches .....	2-2
Output Mute Jumper .....	2-3
Fault Report (SMPTE 269M) Jumper .....	2-3
Equalization Setting .....	2-3
Board Installation .....	2-3
BNC Labels .....	2-3
Cable Connections .....	2-4
LEDs .....	2-4
<b>SMPTE 269M Fault Reporting</b>	<b>3-1</b>
In This Chapter .....	3-1
Overview .....	3-1
Jumper Setup .....	3-2
Frame Connections .....	3-2
Details .....	3-2
<b>Specifications</b>	<b>4-1</b>
In This Chapter .....	4-1
CMA-8011A Technical Specifications .....	4-2
<b>Service Information</b>	<b>5-1</b>
In This Chapter .....	5-1
Troubleshooting Checklist .....	5-1
Warranty and Repair Policy .....	5-2
<b>Ordering Information</b>	<b>6-1</b>
In This Chapter .....	6-1
CMA-8011A Component Monitoring Amp and Related Products .....	6-1





# Introduction

---

## In This Chapter

This chapter contains the following information sections:

- A Word of Thanks
- Overview
- Functional Block Diagram
- Features
- Documentation Terms

### A Word of Thanks

Congratulations on choosing the Ross Video CMA-8011A Component Monitoring Amplifier. The CMA-8011A is part of a full line of digital products within the RossGear Terminal Equipment family of analog and digital products, backed by Ross Video's experience in engineering and design expertise since 1974.

You will be pleased at how easily your new CMA-8011A fits into your overall working environment. Equally pleasing is the product quality, reliability and functionality. Thank you for joining the worldwide group of satisfied Ross Video customers!

Should you have a question pertaining to the installation and operation of your CMA-8011A, please contact us at the numbers listed on the last page of this publication. Our technical support staff is always available for consultation, training, or service.

## Overview

The CMA-8011A Component Monitoring Amplifier provides a convenient and cost effective dual-purpose solution for signal distribution and picture monitoring requirements in serial digital component (4:2:2) systems. The complete unit occupies only a single card slot in a standard RossGear 8000 series digital products rack frame. Ten modules may be mounted in the 2RU frame, with four modules in a 1RU frame.

The CMA-8011A addresses high quality imaging requirements by converting the 8 MsB's of an SDI signal to analog composite video. It uses a 10-bit DAC with a 10MHz bandwidth, thereby achieving low artifact video output.

The CMA-8011A provides four composite analog monitoring outputs and can work in either NTSC or PAL environments. In addition to converting the digital signal, the CMA-8011A also outputs four relocked SDI streams. The SDI input has an exceptionally good cable equalizer that will give error-free performance with up to 305 meters (1000 ft.) of Belden 8281 cable.

Several user-selectable settings are available to place the CMA-8011A into the proper operating mode. Some of these modes are; setting the monitoring outputs to monochrome, output a 75% color bar pattern and blanking the vertical interval.

Of special interest on the CMA-8011A is the inclusion of an adjustable analog cable equalizer for the analog output signal. This adjustment can be set to equalize up to 90 meters (300 ft.) of Belden 8281 cable, thus ensuring that the monitoring signal is delivered to the destination without chroma loss.

The CMA-8011A has card-edge LED indicators to confirm adequate serial digital input signal strength and to indicate monitoring errors.

## Functional Block Diagram

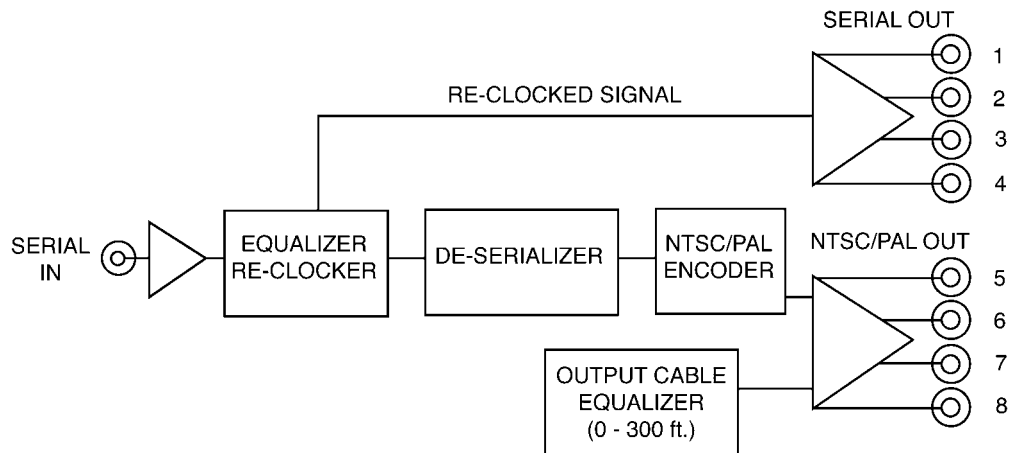

Figure 1. Simplified Block Diagram of CMA-8011A Functions

## Features

The following features make the CMA-8011A one of the finest Component Monitoring Amplifiers on the market today:

- Input and conversion status indicator LED's
- Input level/strength detection
- Auto-reclocking of serial digital input
- Input equalization for up to 305 meters (1000 ft.) of cable
- Four serial digital outputs
- Four NTSC or PAL analog monitoring outputs
- Excellent chroma modulation accuracy
- Cable equalization for monitor outputs
- Fault Reporting (SMPTE 269M)
- Fits Ross Video 8000 series digital products frames and Leitch\* 6800 series frames
- 5-year transferable warranty

## Documentation Terms

The following terms are used throughout this guide:

- “**Frame**” refers to the **DFR-8104A**, and **DFR-8110A** frames that can house the **CMA-8011A** cards. See the respective User Manuals for details.
- “**Operator**” and “**User**” both refer to the person who uses the **CMA-8011A** cards.
- “**Board**”, “**Card**”, and “**Module**” all refer to the **CMA-8011A** modules, including all components.
- “**System**” refers to the mix of interconnected production and terminal equipment in which the **CMA-8011A** cards operate.

---

\* Leitch is a trademark of Leitch Technology Corporation



# Installation and Setup

---

## In This Chapter

This chapter contains the following information sections:

- Static Discharge
- Unpacking
- Analog Output Setup Switches
- Output Mute Jumper
- Fault report Jumper
- Equalization Setting
- Board Installation
- BNC Labels
- Cable Connections
- LEDs

### Static Discharge

Whenever handling the CMA-8011A cards and other related equipment, please observe all static discharge precautions as described in the following note:



Static discharge can cause serious damage to sensitive semiconductor devices. Avoid handling circuit boards in high static environments such as carpeted areas, and when wearing synthetic fiber clothing. Always exercise proper grounding precautions when working on circuit boards and related equipment.

### Unpacking

Unpack each CMA-8011A card you received from the shipping container, and check the contents against the packing list to ensure that all items are included. If any items are missing or damaged, contact your sales representative or Ross Video directly.

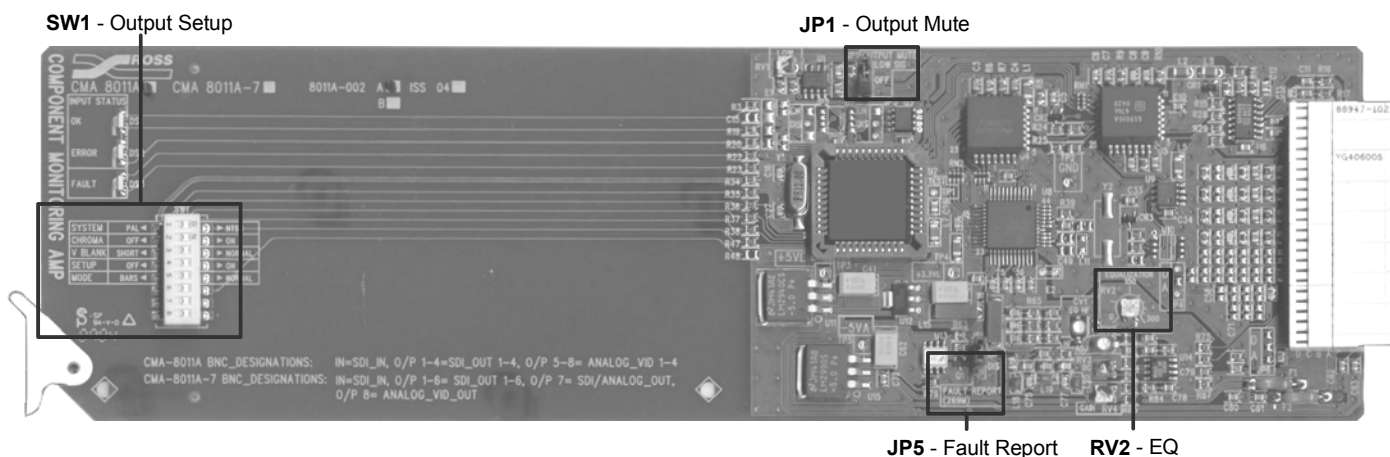

Figure 2. User Control Locations

## Analog Output Setup Switches

Use figure 2, the card labeling, and the following discussion to adjust the switch settings to configure the analog output signal.

Table 1. Switch Settings

Position	Reference	SW1 Label	Description / Function
1	SYSTEM	PAL	For 625 line systems
		NTSC	For 525 line systems
2	CHROMA	ON	The normal position
		OFF	Used to output luminance only for the best picture on a monochrome monitor.
3	V BLANK	NORMAL	Blanks all vertical interval information signals (20-line blanking).
		SHORT	Passes all vertical interval signals occurring after the post-equalizing pulses. If setup is ON, the signal will be non-standard because set-up will be applied to the vertical interval.
4	SETUP	ON	For NTSC - North America
		OFF	For all other systems
5	MODE	NORMAL	Normal operation
		BARS	Produces an analog color bar output. (Requires a valid 270Mb/s input signal.)
6 - 8	Reserved for future use.		

## Output Mute Jumper

Select one of the following options on **JP1** as follows, to enable or disable the Output Mute option:

- **Low Sig** — output will be muted if the input signal degrades to the point that the input EQ can no longer guarantee error-free performance. When the red ERROR LED is on, the outputs will be muted.
- **Off** — the card will work to the limits of the input stage (default setting).

## Fault Report (SMPTE 269M) Jumper

Select SMPTE 269M Fault Reporting, **ENABLED** or **DISABLED**, via **JP5**. The default is **EN**.

See Chapter 3, “SMPTE 269M Fault Reporting” for complete details.

## Equalization Setting

Use figure 2, the card labeling, and the following discussion to adjust the CMA-8011A equalization setting.

Set the analog output EQUALIZATION adjustment (RV2) for the cable length used between the amplifier and analog destination equipment. Plug the board into the frame and apply power.

The equalization control is calibrated for Belden 8281 cable. For other types of cable, put the board on the extender, apply a D1 color bar signal and, using a scope, set the EQUALIZATION adjustment for correct chroma level at the destination.

## Board Installation

Use the following steps to install the CMA-8011A cards in a RossGear DFR-8104A or DFR-8110A digital frame:

1. Refer to the User Manual of the RossGear frame to ensure that the frame is properly installed according to instructions. If this module is to be installed in any compatible frame other than a Ross Video product, refer to the frame manufacturer’s manual for specific instructions.
2. Please note that heat and power distribution requirements within a frame may dictate specific slot placement of cards. Cards with many heat-producing components should be arranged to avoid areas of excess heat build-up, particularly in frames using convectional cooling.
3. After selecting the desired frame installation slot, hold the CMA-8011A card by the edges and carefully align the card edges with the slots in the frame. Then fully insert the card into the frame until the rear connection plug is properly seated.

## BNC Labels

Affix the supplied BNC label, as per the included instructions, to the BNC area on the rear of the rack frame.

## Cable Connections

The following diagram indicates the input and output connections for coax cables to the CMA-8011A when mounted in RossGear 8000 series digital frames.

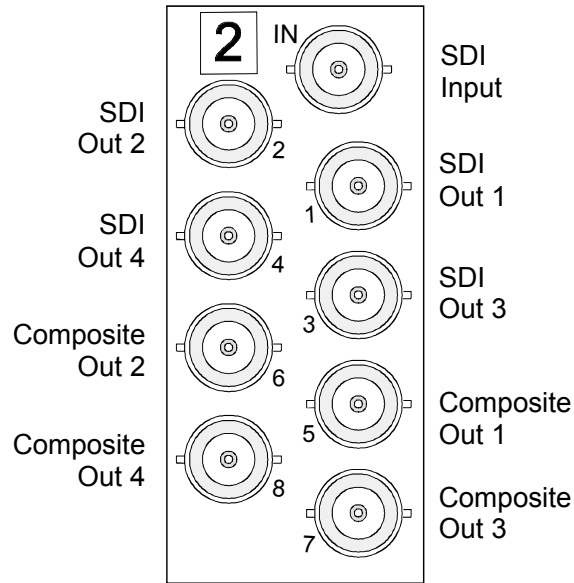

Figure 3. Cabling Designations for RossGear 8000 Series Frames

It is not necessary to terminate unused analog or digital outputs.

## LEDs

The front edge of the module has several LED indicators, which show the status of the amplifier.

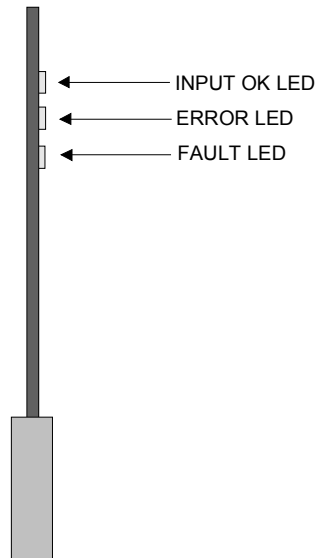

Figure 4. LEDs



The meanings of the LED indicators when lit are as follows:

Table 2. LED Status Indicators

LED	Color	Status Description
OK	Green	The input signal is suitable for achieving error-free performance. It is within the capability of the cable equalizer and reclocking circuit to restore the signal.
ERROR	Red	This indicates that the input signal is too low or absent. In some circumstances, the signal may still be restored correctly but the circuits will be working close to the limit of their capability and reliability cannot be assured.
FAULT	Red	This indicator identifies a problem either with the input signal or with the analog conversion section of the card.
	Red long flash 90% duty cycle	There is no input signal, or the SDI equalizer is working at, or beyond, its maximum capability.
	Red short flash 10% duty cycle	The monitoring amp is on "TEST" mode or the input signal is not a 4:2:2, 270Mb/s signal (i.e. input signal is 143Mb/s 4Fsc).



# SMPTE 269M Fault Reporting

## In This Chapter

This chapter contains the following sections:

- Overview
- Jumper Setup
- Frame Connections
- Details

## Overview

The SMPTE 269M Fault Reporting system, also known as a SMPTE “alarm”, provides indication if one or more frame modules encounter a fault or an abnormal condition. The CMA-8011A module provides a jumper to enable SMPTE-269M fault reporting. The card connects by means of an internal interface circuit to an auxiliary telco connector on RossGear 8000 series frames. When the frame connection is interfaced with a customer-designed system of LEDs or audible alarms, faults can be traced to a specific frame when a card fault occurs within that frame.

The following diagram illustrates a general arrangement for SMPTE 269M alarm reporting:

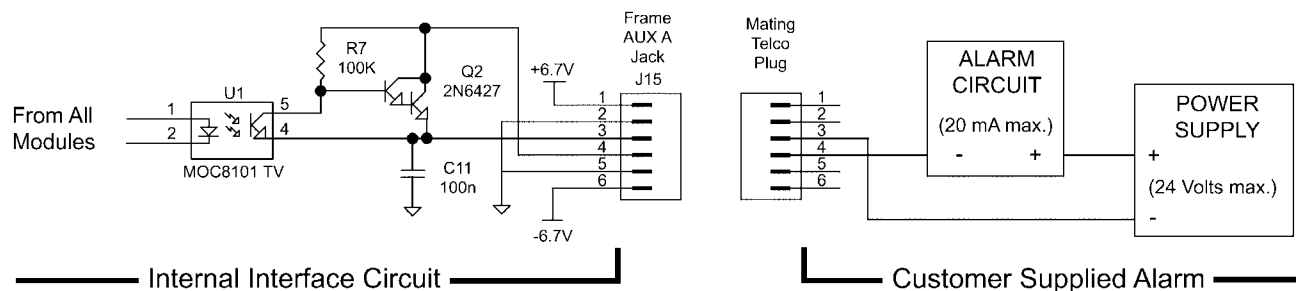

Figure 5. SMPTE 269M Alarm Reporting: Internal interface and typical connections

## Jumper Setup

If fault reporting for the CMA-8011A is desired, use jumper **JP5 - FAULT REPORT (269M)** to set up the card.

1. To access the jumper, remove the card from the frame by pressing down the white card ejector tab and pulling the card from the frame slot.
2. Observing all static discharge and handling precautions, place the card with the component side facing up on a clean flat surface.
3. To enable SMPTE fault reporting, set jumper **JP5** to **EN** position.
4. To disable SMPTE fault reporting, set jumper **JP5** to **DIS** position.

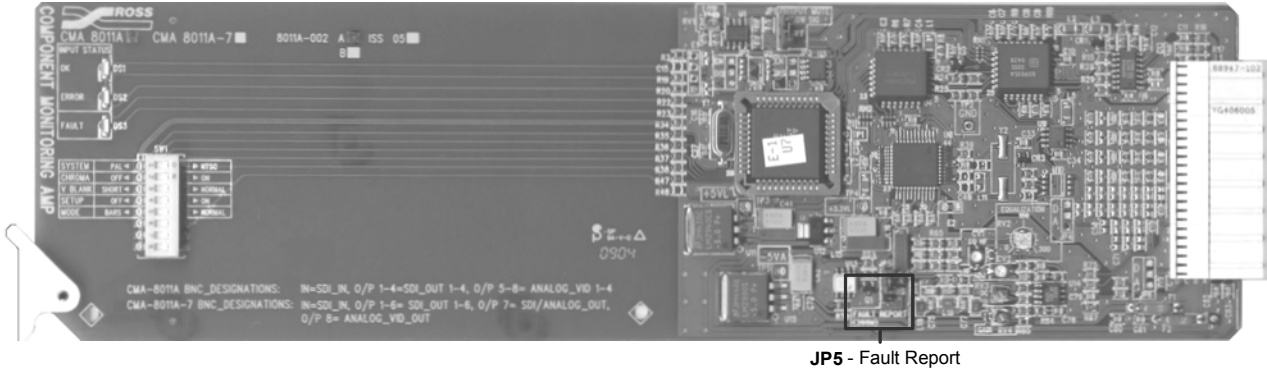

Figure 6. SMPTE 269M Alarm Reporting Jumper Location

## Frame Connections

The SMPTE 269M Fault Reporting connection on RossGear 8000 series frames is provided by the auxiliary telco connector, **AUX A**, for interfacing with a customer-designed alarm system.

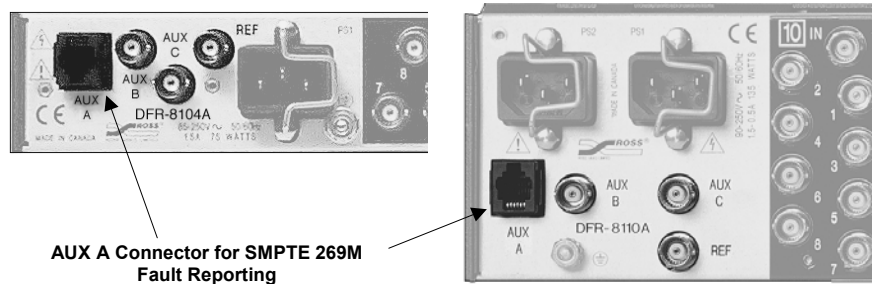

Figure 7. SMPTE 269M Alarm Reporting Frame Connections

## Details

The fault report contacts are closed when the card detects an internal failure or a power loss condition. The fault report will pulse closed for 1 to 2 ms every 16ms when the input signal is low, missing, or invalid.

Some internal failures are:

- Failure of the card to initialize
- Failure in the fault reporting circuitry
- Failure to detect a valid input signal to the card

For additional information on alarm system design, refer to the SMPTE document *ANSI/SMPTE 269M - 1999*.

# Specifications

---

## In This Chapter

This chapter contains the CMA-8011A Technical Specifications table.

# CMA-8011A Technical Specifications

Table 3. Technical Specifications

Category	Parameter	Specification
<b>SDI Input</b>	Number Of Inputs	1
	Standards	SMPTE 259M (conversion at 270Mb/s only)
	Input Impedance	75Ω Terminating
	Return Loss	>19 dB to 270MHz
	Equalization	Automatic up to 31 dB (305m of Belden 8281 @ 270Mb/s)
	Common Mode Rejection	>20Vp-p @ 50/60Hz
<b>SDI Output</b>	Number Of Outputs	4
	Output Impedance	75Ω
	Return Loss	>18dB to 270 MHz
	Signal Level	800mV +/- 10%
	DC Offset	0 Volts +/- 50mV
	Rise and Fall Time (20 - 80%)	850ps Typical
	Overshoot	>8%
	Delay (SDI Input to SDI Output)	>13ns
<b>Analog Monitoring Outputs</b>	Number of Outputs	4
	Standards	NTSC or PAL composite video
	Output Impedance	75Ω
	Output Return Loss	>35dB to 6MHz
	Output Isolation	>34dB to 6MHz
	Nominal Signal Level	1Vp-p
	DC Offset	<± 50mV
	Frequency Response	± 0.25dB to 5MHz typically -1.75dB @ 5.75MHz
	Differential Phase	<1.2°
	Differential Gain	<1.5%
	Group Delay	± 10ns to 5.5MHz
	RMS Noise (unweighted)	-52dB 0 - 5.0MHz
<b>Equalization</b>	0 - 300 Feet	+/-0.5dB
<b>Power Consumption</b>	Positive Rail	475mA
	Negative Rail	10mA
	Total Power Draw	3.3W

Specifications are subject to change without notification.

# Service Information

---

## In This Chapter

This chapter contains the following sections:

- Troubleshooting Checklist
- Warranty and Repair Policy

### Troubleshooting Checklist

Routine maintenance to this RossGear product is not required. In the event of problems with your CMA-8011A, the following basic troubleshooting checklist may help identify the source of the problem. If the module still does not appear to be working properly after checking all possible causes, please contact your Ross Video products distributor, or the Ross Video Technical Support department at the numbers listed under the “Contact Us” section at the end of this manual.

1. **Visual Review** – Performing a quick visual check may reveal many problems, such as connectors not properly seated or loose cables. Check the module, the frame, and any associated peripheral equipment for signs of trouble.
2. **Power Check** – Check the power indicator LED on the distribution frame front panel for the presence of power. If the power LED is not illuminated, verify that the power cable is connected to a power source and that power is available at the power main. Confirm that the power supplies are fully seated in their slots. If the power LED is still not illuminated, replace the power supply with one that is verified to work.
3. **Reseat the Card in the Frame** – Eject the card and reinsert it in the frame.
4. **Check Control Settings** – Refer to the Installation and Operation sections of the manual and verify all user-components.
5. **Input Signal Status** – Verify that source equipment is operating correctly and that a valid signal is being supplied.
6. **Output Signal Path** – Verify that destination equipment is operating correctly and receiving a valid signal.
7. **Module Exchange** – Exchanging a suspect module with a module that is known to be working correctly is an efficient method for localizing problems to individual modules.

## **Warranty and Repair Policy**

The RossGear CMA-8011A is warranted to be free of any defect with respect to performance, quality, reliability, and workmanship for a period of FIVE (5) years from the date of shipment from our factory. In the event that your RossGear CMA-8011A proves to be defective in any way during this warranty period, Ross Video Limited reserves the right to repair or replace this piece of equipment with a unit of equal or superior performance characteristics.

Should you find that this RossGear CMA-8011A has failed after your warranty period has expired, we will repair your defective product for as long as suitable replacement components are available. You, the owner, will bear any labor and/or component costs incurred in the repair or refurbishment of said equipment beyond the FIVE (5) year warranty period.

In no event shall Ross Video Limited be liable for direct, indirect, special, incidental, or consequential damages (including loss of profits) incurred by the use of this product. Implied warranties are expressly limited to the duration of this warranty.

This RossGear CMA-8011A Component Monitoring Amplifier User Manual of our Analog Video Products line provides all pertinent information for the safe installation and operation of your RossGear Product. Ross Video policy dictates that all repairs to the RossGear CMA-8011A are to be conducted only by an authorized Ross Video Limited factory representative. Therefore, any unauthorized attempt to repair this product, by anyone other than an authorized Ross Video Limited factory representative, will automatically void the warranty. Please contact Ross Video Technical Support for more information.

### ***In Case of Problems***

Should any problem arise with your RossGear CMA-8011A, please contact the Ross Video Technical Support Department. (Contact information is supplied at the end of this publication.)

A Return Material Authorization number (RMA) will be issued to you, as well as specific shipping instructions, should you wish our factory to repair your RossGear CMA-8011A. A temporary replacement module, if required, will be made available at a nominal charge. Any shipping costs incurred, will be the responsibility of you, the customer. All products shipped to you from Ross Video Limited, will be shipped collect.

The Ross Video Technical Support department will continue to provide advice on any product manufactured by Ross Video Limited, beyond the warranty period without charge, for the life of this equipment.



# Ordering Information

---

## In This Chapter

This chapter contains ordering information for the CMA-8011A and related products.

### **CMA-8011A Component Monitoring Amp and Related Products**

#### ***Standard Equipment***

- **CMA-8011A** Component Monitoring Amplifier
- **8011ADR-004** Component Monitoring Amplifier User Manual

#### ***Optional Equipment***

- **8011ADR-004** Component Monitoring Amplifier User Manual (additional User Manual)
- **DFR-8104A** Digital Products Frame and Power Supply (PS-8102) (1RU, holds 4 modules, includes 1 power supply)
- **DFR-8104A-C** Digital Products Frame with Cooling Fan Module and Power Supply (PS-8102) (1RU, holds 4 modules, includes 1 power supply)
- **DFR-8110A** Digital Products Frame and Power Supply (PS-8102) (2RU, holds 10 modules, includes 1 power supply)
- **DFR-8110A-C** Digital Products Frame with Cooling Fan Module and Power Supply (PS-8102) (2RU, holds 10 modules, includes 1 power supply)

Your **CMA-8011A Component Monitoring Amplifier** is part of the RossGear family of products. Ross Video offers a full line of RossGEAR terminal equipment including distribution, conversion, monitoring, synchronizers, encoders, decoders, keyers, switchers, as well as analog audio and video products.

**Notes:**

**Notes:**

# Contact Us

Contact our friendly and professional support representatives for the following:

- Name and address of your local dealer
- Product information and pricing
- Technical support
- Upcoming trade show information

<b>PHONE</b>	<b>General Business Office and Technical Support</b>	613 • 652 • 4886
	<b>After-hours Emergency</b>	613 • 652 • 4886 ext. 333
	<b>Fax</b>	613 • 652 • 4425
<b>E-MAIL</b>	<b>General Information</b>	solutions@rossvideo.com
	<b>Technical Support</b>	techsupport@rossvideo.com
<b>POSTAL SERVICE</b>	<b>Ross Video Limited</b>	8 John Street, Iroquois, Ontario, Canada K0E 1K0
	<b>Ross Video Incorporated</b>	P.O. Box 880, Ogdensburg, New York, USA 13669-0880

## Visit Us

Please visit us at our website for:

- Company information
- Related products and full product lines
- On-line catalog
- Trade show information
- News
- Testimonials

[www.rossvideo.com](http://www.rossvideo.com)

---