

ADA-8501

AES Reclocking Distribution Amplifier User Manual

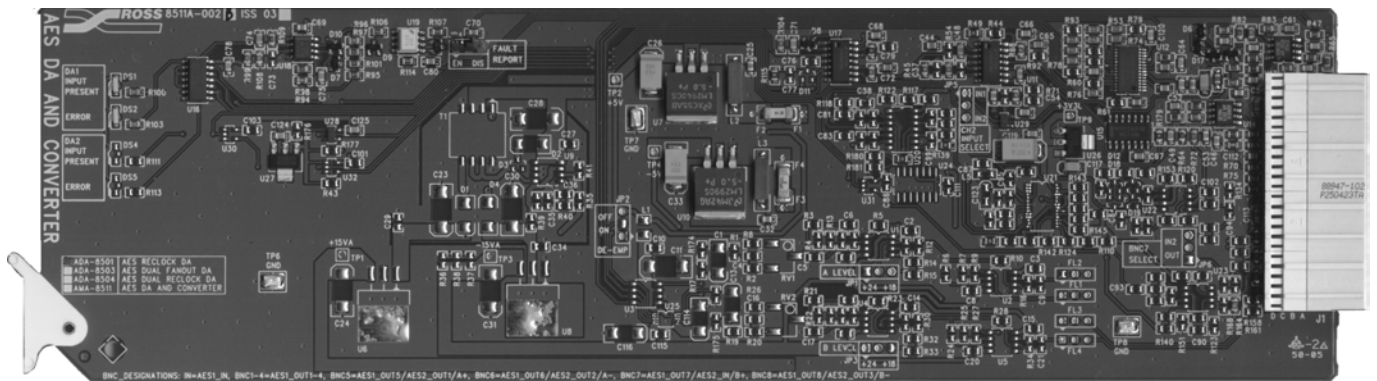

Ross Part Number: 8501D-004
Issue: 03

ADA-8501 • AES Reclocking Distribution Amplifier User Manual

- Ross Part Number: **8501D-004**
- Document Issue: **03**
- Release Date: December 21, 2005. Printed in Canada.

The information contained in this User Manual is subject to change without notice or obligation.

Copyright

© 2005 Ross Video Limited. All rights reserved.

Contents of this publication may not be reproduced in any form without the written permission of Ross Video Limited. Reproduction or reverse engineering of copyrighted software is prohibited.

Notice

The material in this manual is furnished for informational use only. It is subject to change without notice and should not be construed as a commitment by Ross Video Limited. Ross Video Limited assumes no responsibility or liability for errors or inaccuracies that may appear in this manual.

Trademarks

-  is a registered trademark of Ross Video Limited.
- Ross, ROSS, ROSS®, and MLE are registered trademarks of Ross Video Limited.
- All other product names and any registered and unregistered trademarks mentioned in this manual are used for identification purposes only and remain the exclusive property of their respective owners.

Important Regulatory and Safety Notices

Before using this product and any associated equipment, refer to the “Important Safety Instructions” listed below so as to avoid personnel injury and to prevent product damage.

Products may require specific equipment, and /or installation procedures be carried out to satisfy certain regulatory compliance requirements. Notices have been included in this publication to call attention to these Specific requirements.

Symbol Meanings



This symbol on the equipment refers you to important operating and maintenance (servicing) instructions within the Product Manual Documentation. Failure to heed this information may present a major risk of damage or injury to persons or equipment.



Warning

The symbol with the word “**Warning**” within the equipment manual indicates a potentially hazardous situation, which if not avoided, could result in death or serious injury.



Caution

The symbol with the word “**Caution**” within the equipment manual indicates a potentially hazardous situation, which if not avoided, may result in minor or moderate injury. It may also be used to alert against unsafe practices.



Notice

The symbol with the word “**Notice**” within the equipment manual indicates a situation, which if not avoided, may result in major or minor equipment damage or a situation which could place the equipment in a non-compliant operating state.



ESD

Susceptibility

This symbol is used to alert the user that an electrical or electronic device or assembly is susceptible to damage from an ESD event.

Important Safety Instructions



Caution

This product is intended to be a component product of the RossGear 8000 series frame. Refer to the RossGear 8000 series frame User Manual for important safety instructions regarding the proper installation and safe operation of the frame as well as it’s component products.



Warning

Certain parts of this equipment namely the power supply area still present a safety hazard, with the power switch in the OFF position. To avoid electrical shock, disconnect all A/C power cords from the chassis' rear appliance connectors before servicing this area.



Warning

Service barriers within this product are intended to protect the operator and service personnel from hazardous voltages. For continued safety, replace all barriers after any servicing.

This product contains safety critical parts, which if incorrectly replaced may present a risk of fire or electrical shock. Components contained within the product’s power supplies and power supply area, are not intended to be customer serviced and should be returned to the factory for repair.

To reduce the risk of fire, replacement fuses must be the same type and rating.

Only use attachments/accessories specified by the manufacturer.

EMC Notices

US FCC Part 15

This equipment has been tested and found to comply with the limits for a class A Digital device, pursuant to part 15 of the FCC Rules. These limits are designed to provide reasonable protection against harmful interference when the equipment is operated in a commercial environment. This equipment generates, uses, and can radiate radio frequency energy and, if not installed and used in accordance with the instruction manual, may cause harmful interference to radio communications. Operation of this equipment in a residential area is likely to cause harmful interference in which case users will be required to correct the interference at their own expense.



Notice

Changes or modifications to this equipment not expressly approved by Ross Video Ltd. could void the user's authority to operate this equipment.

CANADA

This Class "A" digital apparatus complies with Canadian ICES-003.

Cet appareil numérique de classe "A" est conforme à la norme NMB-003 du Canada.

EUROPE

This equipment is in compliance with the essential requirements and other relevant provisions of **CE Directive 93/68/EEC**.

INTERNATIONAL

This equipment has been tested to **CISPR 22:1997** along with amendments **A1:2000** and **A2:2002** and found to comply with the limits for a Class A Digital device.



Notice

This is a Class A product. In domestic environments this product may cause radio interference in which case the user may have to take adequate measures.

Maintenance/User Serviceable Parts

Routine maintenance to this RossGear product is not required. This product contains no user serviceable parts. If the module does not appear to be working properly, please contact Technical Support using the numbers listed under the "Contact Us" section on the last page of this manual. All RossGear products are covered by a generous 5-year warranty and will be repaired without charge for materials or labor within this period. See the "Warranty and Repair Policy" section in this manual for details.

Environmental Information

The equipment that you purchased required the extraction and use of natural resources for its production. It may contain hazardous substances that could impact health and the environment.

To avoid the potential release of those substances into the environment and to diminish the need for the extraction of natural resources, Ross Video encourages you to use the appropriate take-back systems. These systems will reuse or recycle most of the materials from your end-of-life equipment in an environmentally friendly and health conscious manner.

The crossed-out wheeled bin symbol invites you to use these systems.

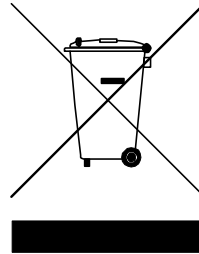

If you need more information on the collection, reuse, and recycling systems, please contact your local or regional waste administration.

You can also contact Ross Video for more information on the environmental performances of our products.



Contents

Introduction	1-1
In This Chapter	1-1
A Word of Thanks	1-1
Overview	1-2
Functional Block Diagram	1-2
Features	1-3
Documentation Terms	1-3
Installation and Setup	2-1
In This Chapter	2-1
Static Discharge	2-1
Unpacking	2-1
Fault Report Jumper Setup	2-2
Board Installation	2-2
BNC Labels	2-2
Cable Connections	2-3
LEDs	2-4
SMPTE 269M Fault Reporting	3-1
In This Chapter	3-1
Overview	3-1
Jumper Setup	3-2
Frame Connections	3-2
Details	3-2
Specifications	4-1
In This Chapter	4-1
Technical Specifications	4-2
Service Information	5-1
In This Chapter	5-1
Troubleshooting Checklist	5-1
Warranty and Repair Policy	5-2
Ordering Information	6-1
In This Chapter	6-1
ADA-8501 and Related Products	6-1

Introduction

In This Chapter

This chapter contains the following information sections:

- A Word of Thanks
- Overview
- Functional Block Diagram
- Features
- Documentation Terms

A Word of Thanks

Congratulations on choosing the Ross Video **ADA-8501 AES Reclocking Distribution Amplifier**. The ADA-8501 is part of a full line of Digital Products within the RossGear Terminal Equipment family of products, backed by Ross Video's experience in engineering and design expertise since 1974.

You will be pleased at how easily your new ADA-8501 fits into your overall working environment. Equally pleasing is the product quality, reliability and functionality. Thank you for joining the group of worldwide satisfied Ross Video customers!

Should you have a question pertaining to the installation or operation of your ADA-8501, please contact us at the numbers listed on the back cover of this manual. Our technical support staff is always available for consultation, training, or service.

Overview

The RossGear AES ADA-8501 Reclocking Distribution Amplifier is a one input, eight output program stream digital audio reclocking distribution amplifier and was specifically designed for use in 75-ohm coaxial (SMPTE 276M or AES-3id) systems. The ADA-8501 reclocks incoming data at 32, 44.1, 48, 88.2, and 96kHz sampling rates and provides automatic cable equalization for lengths beyond 610m (2000 ft.)

The ADA-8501 fits into Ross 8000A series digital frames, the DFR-8110A (2RU) and the DFR-8104A (1RU), and provides system builders with the ability to easily distribute digital audio within a facility. The ADA-8501 also fits Leitch* 6800 series frames.

The ADA 8501 has been designed with the capability to report a variety of AES signal errors including No Lock, Coding, Parity, CRC, and Validity. These errors are indicated on a card edge LED. In addition, there is SMPTE 269M Fault Reporting output to the back of the Ross frame.

A reclocking amplifier is the preferred method of distribution for long coaxial runs to reduce jitter in the data stream. The ADA-8501 performs reclocking in a two-stage process that develops an output which is stable and noise-free.

The ADA-8501 is part of a growing line of RossGear AES solutions that includes distribution, conversion, and monitoring. Designed and manufactured to meet the highest quality broadcast industry standards, the RossGear ADA-8501 is an ideal, cost effective solution for digital audio distribution requirements where reclocking is required.

Functional Block Diagram

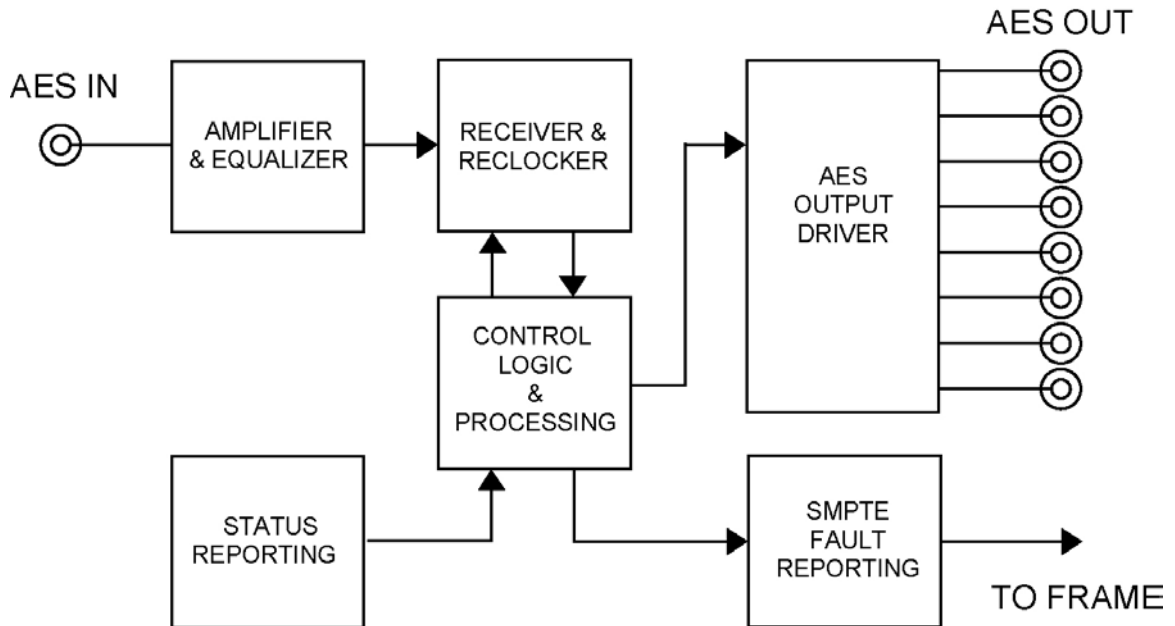

Figure 1. Simplified Block Diagram of ADA-8501 Functions

* Leitch is a trademark of Leitch Technology Corporation

Features

The following features make the ADA-8501 AES Reclocking Distribution Amplifier a great choice for your AES reclocking distribution requirements:

- Support for any sampling rate in the 31kHz to 100kHz range including 32kHz, 44.1kHz, 48kHz, 64kHz, 88.2kHz and 96kHz
- Conformity to AES-3id 1995
- Reclocking of input signal to reduce output jitter and noise
- 8 reclocked outputs at 75Ω
- Terminating input 75Ω
- Auto equalization for 610m (2000 ft.) of Belden 8281 cable
- Ten card capacity in the Ross DFR-8110A (2RU) digital rack frame
- Four card capacity in the Ross DFR-8104A (1RU) digital rack frame
- Fits Leitch 6800 series frames
- Visual indication of signal presence
- Visual indication of an error condition
- SMPTE 269M Fault Reporting
- 5-year transferable warranty

Documentation Terms

The following terms are used throughout this guide:

- “**Frame**” refers to the **DFR-8104A** and **DFR-8110A** frames that house the **ADA-8501** card.
- All references to the **DFR-8104A** and **DFR-8110A** also include the **DFR-8104A-C** and **DFR-8110A-C** versions with the cooling fan option. See the respective User Manuals for details.
- “**Operator**” and “**User**” both refer to the person who uses the **ADA-8501**.
- “**Board**”, “**Card**”, and “**Module**” all refer to the **ADA-8501** board itself, including all components and switches.
- “**System**” and “**Video system**” refers to the mix of interconnected production and terminal equipment in which the **ADA-8501** operates.

Installation and Setup

In This Chapter

This chapter contains the following information sections:

- Static Discharge
- Unpacking
- Fault Report Jumper Setup
- Board Installation
- BNC Labels
- Cable Connections
- LEDs

Static Discharge

Whenever handling the ADA-8501 and other related equipment, please observe all static discharge precautions as described in the following note:



Static discharge can cause serious damage to sensitive semiconductor devices. Avoid handling circuit boards in high static environments such as carpeted areas, and when wearing synthetic fiber clothing. Always exercise proper grounding precautions when working on circuit boards and related equipment.

Unpacking

Unpack each ADA-8501 you received from the shipping container, and check the contents against the packing list to ensure that all items are included. If any items are missing or damaged, contact your sales representative or Ross Video directly.

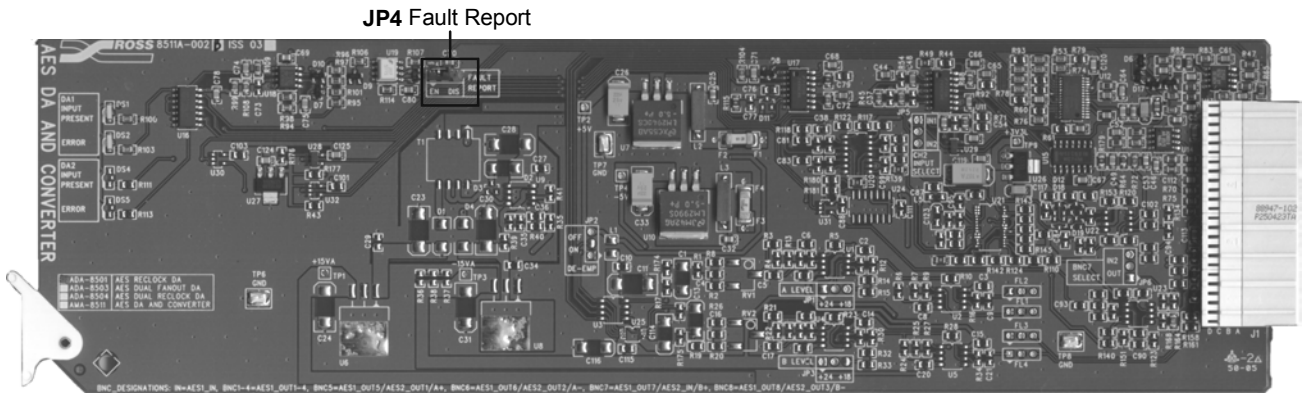

Figure 2. Jumper Locations

Fault Report Jumper Setup

Select SMPTE 269M Fault Reporting, **ENABLED** or **DISABLED**, via **JP4**. The default is **EN**.

See Chapter 3, “SMPTE 269M Fault Reporting” for details on fault reporting.

Board Installation

Use the following steps to install the ADA-8501 in a RossGear 8000 series digital distribution frame:

1. Refer to the User Manual of the RossGear 8000 series frame, to ensure that the frame is properly installed according to instructions. If this module is to be installed in any compatible frame other than a Ross Video product, refer to the frame manufacturer’s manual for specific instructions.
2. Please note that heat and power distribution requirements within a frame may dictate specific slot placement of cards. Cards with many heat-producing components should be arranged to avoid areas of excess heat build-up, particularly in frames using convectational cooling.
3. After selecting the desired frame installation slot, hold the ADA-8501 card by the edges and carefully align the card edges with the slots in the frame. Then fully insert the card into the frame until the rear connection plug is properly seated.

BNC Labels

Affix the supplied BNC label, as per the included instructions, to the BNC area on the rear of the rack frame.

Cable Connections

This section provides instructions for connecting cables to the ADA-8501 when mounted in RossGear 8000 series Digital Products Frames. The cable connectors on the rear of the frame are marked for distribution amplifiers having one input and eight outputs. The ADA-8501 cable connections match the frame designations.

Connect the input and output cables according to the frame rear panel connections diagram in the following figure. The input is internally terminated in 75 ohms. It is not necessary to terminate unused outputs.

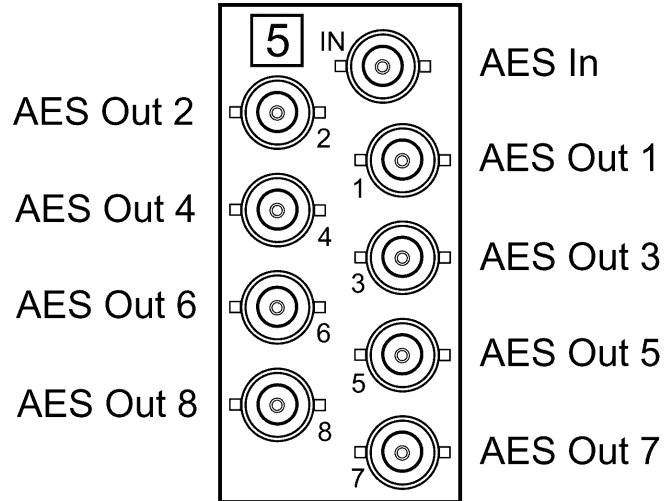

Figure 3. ADA-8501 BNC Designations for RossGear DFR-8110A (2RU frame)

LEDs

The front edge of the module has two LED indicators, which show the status of the amplifier. They are described in the following figure and table. The module is operating correctly when the Input Present LED is lit and the Error LED is not lit.

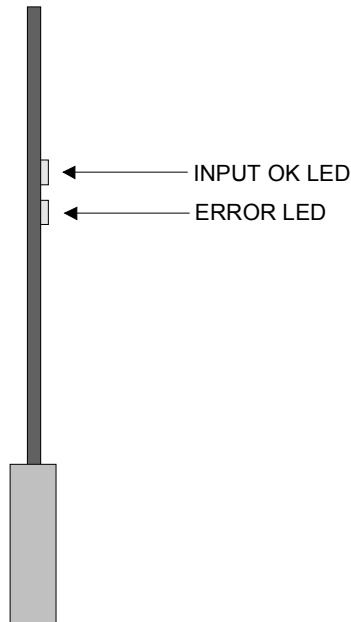

Figure 4. ADA-8501 LEDs

Table 1. ADA-8501 Status LED Indicator Descriptions

LED	Reference	Status Description
Input Present	Green	Indicates presence of an input signal.
Error	Red	One or more of the following problems have been encountered: <ol style="list-style-type: none"> 1. No Lock – Unable to lock to the incoming signal 2. Coding - Bi-phase coding violation 3. Parity - There is a parity error 4. CRC - Error in the CRC calculation 5. Validity - The integrity of this sample is in question

SMPTE 269M Fault Reporting

In This Chapter

This chapter contains the following sections:

- Overview
- Jumper Setup
- Frame Connections
- Details

Overview

The SMPTE 269M Fault Reporting system, also known as a SMPTE “alarm”, provides indication if one or more frame modules encounter a fault or an abnormal condition. The ADA-8501 module provides a jumper to enable SMPTE-269M fault reporting. The card connects by means of an internal interface circuit to an auxiliary telco connector on RossGear 8000 series frames. When the frame connection is interfaced with a customer-designed system of LEDs or audible alarms, faults can be traced to a specific frame when a card fault occurs within that frame.

The following diagram illustrates a general arrangement for SMPTE 269M alarm reporting:

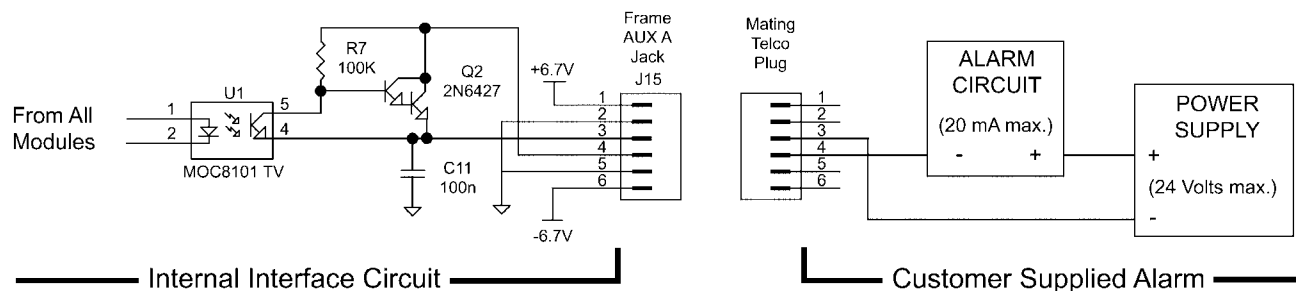

Figure 5. SMPTE 269M Alarm Reporting: Internal interface and typical connections

Jumper Setup

If fault reporting for the ADA-8501 is desired, use jumper **JP4 - 269M FAULT REPORT** to set up the card.

1. To access the jumper, remove the card from the frame by pressing down the white card ejector tab and pulling the card from the frame slot.
2. Observing all static discharge and handling precautions, place the card with the component side facing up on a clean flat surface.
3. To enable SMPTE fault reporting, set jumper **JP4** to **EN** position.
4. To disable SMPTE fault reporting, set jumper **JP4** to **DIS** position.

Frame Connections

The SMPTE 269M Fault Reporting connection on RossGear 8000 series frames is provided by the auxiliary telco connector, **AUX A**, for interfacing with a customer-designed alarm system.

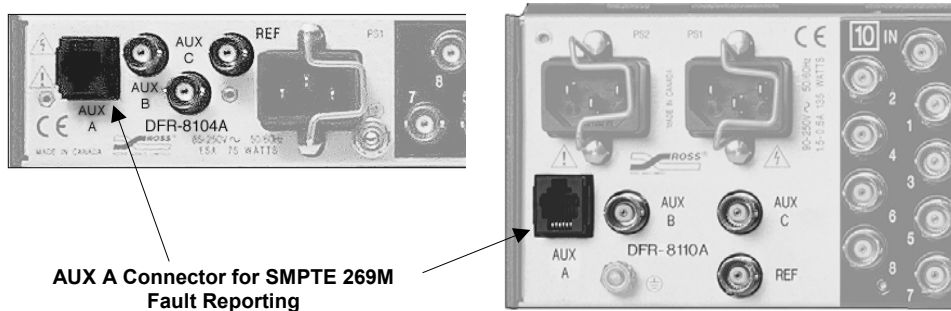

Figure 6. SMPTE 269M Alarm Reporting Frame Connections

Details

The fault report contacts are closed when the card detects an internal failure or a power loss condition. The fault report will pulse off for 1 to 2 ms about every 16ms if the input signal is low or missing.

Some internal failures are:

- Failure of the card to initialize
- Failure in the fault reporting circuitry
- Failure to detect a valid input signal to the card

For additional information on alarm system design, refer to the SMPTE document *ANSI/SMPTE 269M - 1999*.

Specifications

In This Chapter

This chapter contains the Technical Specifications table.

Technical Specifications

Table 2. ADA-8501 - Technical Specifications

Category	Parameter	Specification
AES Input	Number of Inputs	1
	Standards	AES-3id (SMPTE 276M)
	Sampling Rates	All rates in the 31kHz to 100kHz range
	Input Impedance	75Ω
	Connector	BNC
	Input Return Loss	>40dB to 6MHz
	Equalization	>610m (2000 ft.) of Belden 8281
	Input Level	1V p-p nominal
	Max. Common Mode Signal	12Vp-p @ 50/60Hz
AES Output	Number of Outputs	8
	Standards	AES-3id (SMPTE 276M)
	Output Impedance	75Ω
	Output Isolation	48dB
	Signal Level	1.0V p-p ±10%
	Rise and Fall Time	30ns Typical
	Output Jitter	<3ns peak @ 48kHz (<18.4mUI)
	Output Return Loss	>50dB to 6MHz
	Electrical Path Length	262ns @ 48kHz
Environmental	Operating Range	5 °C – 40 °C ambient
Power	Total Consumption	1.25W

Specifications are subject to change without notification.

Service Information

In This Chapter

This chapter contains the following sections:

- Troubleshooting Checklist
- Warranty and Repair Policy

Troubleshooting Checklist

Routine maintenance to this RossGear product is not required. In the event of problems with your ADA-8501, the following basic troubleshooting checklist may help identify the source of the problem. If the module still does not appear to be working properly after checking all possible causes, please contact your Ross Video products distributor, or the Ross Video Technical Support department at the numbers listed under the “Contact Us” section at the end of this manual.

1. **Visual Review** – Performing a quick visual check may reveal many problems, such as connectors not properly seated or loose cables. Check the module, the frame, and any associated peripheral equipment for signs of trouble.
2. **Power Check** – Check the power indicator LED on the distribution frame front panel for the presence of power. If the power LED is not illuminated, verify that the power cable is connected to a power source and that power is available at the power main. Confirm that the power supplies are fully seated in their slots. If the power LED is still not illuminated, replace the power supply with one that is verified to work.
3. **Reseat the Card in the Frame** – Eject the card and reinsert it in the frame.
4. **Check Control Settings** – Refer to the Installation and Operation sections of the manual and verify all user-adjustable component settings.
5. **Input Signal Status** – Verify that source equipment is operating correctly and that a valid signal is being supplied.
6. **Output Signal Path** – Verify that destination equipment is operating correctly and receiving a valid signal.
7. **Module Exchange** – Exchanging a suspect module with a module that is known to be working correctly is an efficient method for localizing problems to individual modules.

Warranty and Repair Policy

The RossGear ADA-8501 is warranted to be free of any defect with respect to performance, quality, reliability, and workmanship for a period of FIVE (5) years from the date of shipment from our factory. In the event that your RossGear ADA-8501 proves to be defective in any way during this warranty period, Ross Video Limited reserves the right to repair or replace this piece of equipment with a unit of equal or superior performance characteristics.

Should you find that this RossGear ADA-8501 has failed after your warranty period has expired, we will repair your defective product should suitable replacement components be available. You, the owner, will bear any labor and/or part costs incurred in the repair or refurbishment of said equipment beyond the FIVE (5) year warranty period.

In no event shall Ross Video Limited be liable for direct, indirect, special, incidental, or consequential damages (including loss of profits) incurred by the use of this product. Implied warranties are expressly limited to the duration of this warranty.

This RossGear ADA-8501 User Manual provides all pertinent information for the safe installation and operation of your RossGear Product. Ross Video policy dictates that all repairs to the RossGear ADA-8501 are to be conducted only by an authorized Ross Video Limited factory representative. Therefore, any unauthorized attempt to repair this product, by anyone other than an authorized Ross Video Limited factory representative, will automatically void the warranty. Please contact Ross Video Technical Support for more information.

In Case of Problems

Should any problem arise with your RossGear ADA-8501, please contact the Ross Video Technical Support Department. (Contact information is supplied at the end of this publication.)

A Return Material Authorization number (RMA) will be issued to you, as well as specific shipping instructions, should you wish our factory to repair your RossGear ADA-8501. If required, a temporary replacement module will be made available at a nominal charge. Any shipping costs incurred will be the responsibility of you, the customer. All products shipped to you from Ross Video Limited will be shipped collect.

The Ross Video Technical Support Department will continue to provide advice on any product manufactured by Ross Video Limited, beyond the warranty period without charge, for the life of the equipment.

Ordering Information

In This Chapter

This chapter contains ordering information for the ADA-8501 and related products.

ADA-8501 and Related Products

Standard Equipment

- **ADA-8501** AES Reclocking Distribution Amplifier

Optional Equipment

- **8501D-004** AES Reclocking Distribution Amplifier User Manual (additional User Manual)
- **DFR-8104A** Digital Products Frame and Power Supply (PS-8102) (1RU, holds 4 modules, includes 1 power supply)
- **DFR-8104A-C** Digital Products Frame with Cooling Fan Module and Power Supply (PS-8102) (1RU, holds 4 modules, includes 1 power supply)
- **DFR-8110A** Digital Products Frame and Power Supply (PS-8102) (2RU, holds 10 modules, includes 1 power supply)
- **DFR-8110A-C** Digital Products Frame with Cooling Fan Module and Power Supply (PS-8102) (2RU, holds 10 modules, includes 1 power supply)
- **EXT-8100** Extender Board (module servicing extension)

Your **ADA-8501 AES Reclocking Distribution Amplifier** is a part of the RossGear family of products. Ross Video offers a full line of RossGear terminal equipment including distribution, conversion, monitoring, synchronizers, encoders, decoders, keyers, switches, as well as analog audio and video products.

Contact Us

Contact our friendly and professional support representatives for the following:

- Name and address of your local dealer
- Product information and pricing
- Technical support
- 7Upcoming trade show information

PHONE	General Business Office and Technical Support	613 • 652 • 4886
	After-hours Support	613 • 349 • 0006
	Fax	613 • 652 • 4425
E-MAIL	General Information	solutions@rossvideo.com
	Technical Support	techsupport@rossvideo.com
POSTAL SERVICE	Ross Video Limited	8 John Street, Iroquois, Ontario, Canada K0E 1K0
	Ross Video Incorporated	P.O. Box 880, Ogdensburg, New York, USA 13669-0880

Visit Us

Please visit us at our website for:

- Company information
- Related products and full product lines
- On-line catalog
- Trade show information
- News
- Testimonials

www.rossvideo.com
