

---

Ross Video Limited

CROSSOVER

**CrossOver 6  
CrossOver 12  
Operator's Manual**

**Software Issue: 4.0**

***ROSS***

---

## CrossOver 6 / 12 • User Manual

- Ross Part Number: **4801DR-002-4.0A**
- Release Date: February 21, 2011. Printed in Canada.
- Software Issue: **4.0**

The information contained in this manual is subject to change without notice or obligation.

## Copyright

© 2011 Ross Video Limited. All rights reserved.

Contents of this publication may not be reproduced in any form without the written permission of Ross Video Limited. Reproduction or reverse engineering of copyrighted software is prohibited.

## Patents

This product is protected by the following US Patents: 4,205,346; 5,115,314; 5,280,346; 5,561,404; 7,034,886; 7,508,455; 7,602,446; 7,834,886. This product is protected by the following Canadian Patents: 2039277; 1237518; 1127289. Other patents pending.

## Notice

The material in this manual is furnished for informational use only. It is subject to change without notice and should not be construed as commitment by Ross Video Limited. Ross Video Limited assumes no responsibility or liability for errors or inaccuracies that may appear in this manual.

## Trademarks

- ***ROSS*** is a trademark of Ross Video Limited.
- Ross, ROSS, ROSS®, CrossOver, and MLE are registered trademarks of Ross Video Limited.
- All other product names and any registered and unregistered trademarks mentioned in this guide are used for identification purposes only and remain the exclusive property of their respective owners.

## Important Regulatory and Safety Notices to Service Personnel

Before using this product and any associated equipment, refer to the “**Important Safety Instructions**” listed below to avoid personnel injury and to prevent product damage.

Product may require specific equipment, and/or installation procedures to be carried out to satisfy certain regulatory compliance requirements. Notices have been included in this publication to call attention to these specific requirements.

## Symbol Meanings



**Protective Earth** — This symbol identifies a Protective Earth (PE) terminal, which is provided for connection of the supply system’s protective earth (green or green/yellow) conductor.



This symbol on the equipment refers you to important operating and maintenance (servicing) instructions within the Product Manual Documentation. Failure to heed this information may present a major risk of damage or injury to persons or equipment.



**Warning** — The symbol with the word “**Warning**” within the equipment manual indicates a potentially hazardous situation which, if not avoided, could result in death or serious injury.



**Caution** — The symbol with the word “**Caution**” within the equipment manual indicates a potentially hazardous situation which, if not avoided, may result in minor or moderate injury. It may also be used to alert against unsafe practices.



**Warning Hazardous Voltages** — This symbol is intended to alert the user to the presence of uninsulated “dangerous voltage” within the product enclosure that may be of sufficient magnitude to constitute a risk of shock to persons.



**ESD Susceptibility** — This symbol is used to alert the user that an electrical or electronic device or assembly is susceptible to damage from an ESD event.

## Important Safety Instructions



### Warning

1. Read these instructions.
2. Keep these instructions.
3. Heed all warnings.
4. Follow all instructions.
5. Do not use this apparatus near water.
6. Clean only with a dry cloth.
7. Do not block any ventilation openings. Install in accordance with manufacturer’s instructions.
8. Do not install near heat sources such as radiators, heat registers, stoves, or other apparatus (including amplifiers) that produce heat.
9. Do not defeat the safety purpose of the polarized or grounding-type plug. A polarized plug has two blades with one wider than the other. A grounding type plug has two blades and a third grounding prong. The third prong is provided for your safety. If the provided plug does not fit into your outlet, consult an electrician for replacement of the obsolete outlet.
10. Protect the power cord from being walked on or pinched, particularly at plugs, convenience receptacles, and the point where they exit from the apparatus.
11. Only use attachments/accessories specified by the manufacturer.
12. Unplug this apparatus during lightning storms or when unused for long periods of time.
13. Refer all servicing to qualified service personnel. Servicing is required when the apparatus has been damaged in any way, such as when the power-supply cord or plug is damaged, liquid has been spilled or objects have fallen into the apparatus, the apparatus has been exposed to rain or moisture, does not operate normally, or has been dropped.
14. Do not expose this apparatus to dripping or splashing, and ensure that no objects filled with liquids, such as vases, are placed on the apparatus.
15. To completely disconnect this apparatus from the AC Mains, disconnect the power supply cord plug from the AC receptacle.
16. The mains plug of the power supply cord shall remain readily operable.



### Warning

17. **Indoor Use: WARNING:** To reduce the risk of fire or electric shock, do not expose this apparatus to rain or moisture.
18. The safe operation of this product requires that a protective earth connection be provided. A grounding conductor in the equipment's supply cord provides this protective earth. To reduce the risk of electrical shock to the operator and service personnel, this ground conductor must be connected to an earthed ground.



### Warning

19. **WARNING:** This product includes an “Ethernet Port” which allows this product to be connected to a local area network (LAN). Only connect to networks that remain inside the building. Do not connect to networks that go outside the building.
20. **WARNING:** This apparatus, when equipped with multiple power supplies, can generate high leakage currents. To reduce the risk of electric shock, ensure that each individual supply cord is connected to its own separate branch circuit with an earth connection.

21. **CAUTION:** These service instructions are for use by qualified service personnel only. To reduce the risk of electric shock, do not perform any servicing other than that contained in the operating instructions unless you are qualified to do so.
22. Service barriers within this product are intended to protect the operator and service personnel from hazardous voltages. For continued safety, replace all barriers after servicing.
23. Certain parts of this equipment still present a safety hazard with the power switch in the OFF position. To avoid electrical shock, disconnect all A/C power cords from the chassis' rear appliance connectors before servicing.
24. This product contains safety critical parts, which, if incorrectly replaced, may present a risk of fire or electrical shock. Components contained within the product's power supplies and power supply area are not intended to be customer-serviced and should be returned to the factory for repair.
25. To reduce the risk of fire, replacement fuses must be the same type and rating.
26. Use only power cords specified for this product and certified for the country of use. Refer to the Product Power Cord Requirement section that follows.
27. The safe operation of this equipment requires that the user heed and adhere to all installation and servicing instruction contained within the equipment's User Manual.

## EMC Notices

### United States of America FCC Part 15

This equipment has been tested and found to comply with the limits for a class A Digital device, pursuant to part 15 of the FCC Rules. These limits are designed to provide reasonable protection against harmful interference when the equipment is operated in a commercial environment. This equipment generates, uses, and can radiate radio frequency energy and, if not installed and used in accordance with the instruction manual, may cause harmful interference to radio communications. Operation of this equipment in a residential area is likely to cause harmful interference in which case the user will be required to correct the interference at his own expense.



**Notice** — Changes or modifications to this equipment not expressly approved by Ross Video Limited could void the user's authority to operate this equipment.

### CANADA

This Class "A" digital apparatus complies with Canadian ICES-003.

Cet appareil numérique de la classe "A" est conforme à la norme NMB-003 du Canada.

### EUROPE

This equipment is in compliance with the essential requirements and other relevant provisions of **CE Directive 93/68/EEC**.

### INTERNATIONAL

This equipment has been tested to **CISPR 22:1997** along with amendments **A1:2000** and **A2:2002**, and found to comply with the limits for a Class A Digital device.



**Notice** — This is a Class A product. In domestic environments, this product may cause radio interference, in which case the user may have to take adequate measures.

### General Handling Guidelines

- Careful handling, using proper ESD precautions, must be observed.
- Power down the system before PCB removal.

## A Word About Static Discharge

Throughout the many procedures in this Engineering Manual, please observe all static discharge precautions.



**Caution** — Avoid handling the switcher circuit boards in high static environments such as carpeted areas, and when synthetic fiber clothing is worn. Touch the frame to dissipate static charge before removing boards from the frame, and exercise proper grounding precautions when working on circuit boards.

## Warranty and Repair Policy

Ross Video Limited (Ross) warrants its switchers and related options, to be free from defects under normal use and service for a period of ONE YEAR from the date of shipment. Fader handle assemblies are warranted for the life of the product. If an item becomes defective within the warranty period Ross will repair or replace the defective item, as determined solely by Ross.

Warranty repairs will be conducted at Ross, with all shipping FOB Ross dock. If repairs are conducted at the customer site, reasonable out-of-pocket charges will apply. At the discretion of Ross, and on a temporary loan basis, plug in circuit boards or other replacement parts may be supplied free of charge while defective items undergo repair. Return packing, shipping, and special handling costs are the responsibility of the customer.

Software upgrades for switchers may occur from time to time, and are determined by Ross Video. The upgrades are posted on the Ross Video website, and are free of charge for the life of the switcher.

This warranty is void if products are subjected to misuse, neglect, accident, improper installation or application, or unauthorized modification.

In no event shall Ross Video Limited be liable for direct, indirect, special, incidental, or consequential damages (including loss of profit). Implied warranties, including that of merchantability and fitness for a particular purpose, are expressly limited to the duration of this warranty.

This warranty is TRANSFERABLE to subsequent owners, subject to Ross' notification of change of ownership.

## Environmental Information

The equipment that you purchased required the extraction and use of natural resources for its production. It may contain hazardous substances that could impact health and the environment.

To avoid the potential release of those substances into the environment and to diminish the need for the extraction of natural resources, Ross Video encourages you to use the appropriate take-back systems. These systems will reuse or recycle most of the materials from your end-of-life equipment in an environmentally friendly and health conscious manner.

The crossed-out wheeled bin symbol invites you to use these systems.



If you need more information on the collection, reuse, and recycling systems, please contact your local or regional waste administration.

You can also contact Ross Video for more information on the environmental performances of our products.

## Company Address



### **Ross Video Limited**

8 John Street  
Iroquois, Ontario, K0E 1K0  
Canada

### **Ross Video Incorporated**

P.O. Box 880  
Ogdensburg, New York  
USA 13669-0880

---

General Business Office: (+1) 613 • 652 • 4886

Fax: (+1) 613 • 652 • 4425

Technical Support: (+1) 613 • 652 • 4886

After hours emergency: (+1) 613 • 349 • 0006

E-mail (Technical Support): [techsupport@rossvideo.com](mailto:techsupport@rossvideo.com)

E-mail (General Information): [solutions@rossvideo.com](mailto:solutions@rossvideo.com)

Website: <http://www.rossvideo.com>

# Contents

<b>Introduction</b>	<b>1</b>	<b>Advanced Operation</b>	<b>4</b>
About This Manual .....	1-1	Transition Limit .....	4-1
Documentation Terms .....	1-1	Modifying Wipes .....	4-1
Technical Support .....	1-1	Modifying DVE Transitions .....	4-2
Switcher Installation .....	1-1	Advanced Keying .....	4-3
Control Panel Overview .....	1-2	Aux Buses .....	4-5
Control Panel Rear Connections Overview .....	1-3	Creating an FTP Connection .....	4-6
Frame Overview .....	1-3	Live Edit Decision Lists (EDL) .....	4-7
Frame Rear Connections Overview .....	1-3	Reset Options .....	4-9
Removing the Frame Door .....	1-4	Tallies .....	4-11
Menu System .....	1-4	Device Control .....	4-11
Knobs .....	1-5	General Purpose Interface (GPI) .....	4-14
Buttons .....	1-5	Triggering GPI Outputs .....	4-15
Button Inserts .....	1-5	Transition Pre-Delay .....	4-17
Shift .....	1-6	Editor Port .....	4-17
Fader .....	1-6		
Positioner .....	1-6	<b>Memories, USB Storage, and Up-</b>	
Selecting Colors .....	1-6	<b>grades</b>	<b>5</b>
		Memory System Overview .....	5-1
<b>Configuration</b>	<b>2</b>	Memory Attributes .....	5-1
Reference Type .....	2-1	Storing Memory Registers .....	5-4
Switcher Video Format .....	2-1	Recalling Memory Registers .....	5-4
Format Conversion and Frame Sync .....	2-1	USB Storage .....	5-6
Output Reference Sync .....	2-4	Software Upgrades .....	5-8
Aspect Ratio .....	2-5		
Ancillary Data .....	2-5	<b>Media-Store</b>	<b>6</b>
Input BNC Configuration .....	2-6	Media-Store Overview .....	6-1
Clean Feed .....	2-6	Media-Store Modes .....	6-1
MultiViewer .....	2-7	File Formats .....	6-1
CrossOver CleanSwitch .....	2-8	Loading Media by Browsing .....	6-2
IP Address .....	2-8	Loading Media by FTP .....	6-2
Bus Map .....	2-9	Understanding Media Numbers .....	6-3
Switcher Personality .....	2-9	Loading Media by Media Number .....	6-3
		Media-Store Attributes .....	6-4
<b>Basic Operation</b>	<b>3</b>	Animation Control .....	6-5
Transition Overview .....	3-1	Saving and Reverting Attributes .....	6-6
Configuring the Auto Trans Rate .....	3-2		
Wipe Transitions .....	3-2	<b>Calibration and Diagnostics</b>	<b>7</b>
DVE Transitions .....	3-2	Switcher Software Version .....	7-1
Media Transitions .....	3-3	Copy Logs to USB .....	7-1
Pausing a Transition .....	3-3	Calibration .....	7-1
Keying Overview .....	3-4	Diagnostics .....	7-1
Key Transitions .....	3-4	Error Messages .....	7-3
Dedicated Key Transitions .....	3-5		
UltraChrome Chroma Key .....	3-6	<b>Specifications</b>	<b>8</b>
DVE Key .....	3-10	Dimensions .....	8-1
Mattes .....	3-11	Weight .....	8-1
Fade to Black .....	3-12	Power Requirements .....	8-1
		Ports .....	8-1

Video Formats .....	8-1
Inputs/Outputs .....	8-1
GVG Editor Input Mapping .....	8-2
GVG100 Protocol Supported Commands .....	8-3



# What's New

The following features are new or have been updated in this software version:

- Setting Analog Output Reference Color Framing ..... 2-5
- Background Double-Press ..... 2-14
- Media Transitions ..... 3-3
- UltraChrome Chroma Key ..... 3-6
- Accessing Aux Buses..... 4-5
- Memory Attributes ..... 5-1



# Introduction

The CrossOver 6 and CrossOver 12 combine professional switcher quality with an easy to use and mobile design. They can be easily integrated into your workflow to create professional style broadcasts.

## About This Manual

Before operating your switcher, please read this manual carefully and store it in a safe and accessible place for future reference.

This manual is designed to familiarize the user with switcher layout, menu navigation, basic and advanced operation.

Several switcher functions are customizable. When using this manual, consider your requirements and style when adjusting items that involve colors, patterns, and effects. The manual provides instructions on how to adjust these items but you can tailor their use to your production requirements.

## Documentation Terms

- “**Switcher**” refers to the CrossOver 6 or the CrossOver 12 switcher.
- “**Operator**,” “**User**,” and “**You**” refer to the person who uses the switcher.
- “**HD-SDI**” refers to High Definition Serial Digital Interface, a digital video signal that is distributed via a single coaxial cable with BNC connectors.
- “**Setup**” refers to a group, or set, of values that are stored together either on the switcher or USB drive. Setups can be stored and recalled to quickly configure the switcher for different productions.

## Abbreviations

The following abbreviations are used throughout the manual:

- **AUX** (Auxiliary)
- **DVE** (Digital Video Effects)
- **EDL** (Edit Decision List)
- **HD** (High Definition)
- **HD-SDI** (High Definition Serial Digital Interface)
- **MD** (Multi-Definition)
- **NLE** (Non-Linear Editor)
- **PGM** (Program)

- **PST** (Preset)
- **PV** (Preview)
- **SD** (Standard Definition)

## Technical Support

At Ross Video, we take pride in the quality of our products, but if a problem does occur, help is as close as the nearest telephone.

Our 24-Hour Hot Line service ensures you have access to technical expertise around the clock. After-sales service and technical support are provided directly by Ross Video personnel. During business hours (eastern standard time), technical support personnel are available by telephone any time. Outside of normal business hours and on weekends, a direct emergency technical support phone line is available. If the technical support personnel who is on call does not answer this line immediately, a voice message can be left and the call will be returned shortly. Our technical support staff are available to react to any problem and to do whatever is necessary to ensure customer satisfaction.

- **Technical Support:** (+1) 613-652-4886
- **After Hours Emergency:** (+1) 613-349-0006

## Switcher Installation

### Control Panel

The switcher control panel is designed to sit on a desk or table. Alternately, it may be mounted in-desk or rack-mounted, both of which require the addition of a rackmount kit. Contact your dealer or Ross Video for information on the Rackmount kit.

### Switcher Frame

Under normal conditions, mounting the frame to the front of a standard equipment rack with four rack screws is sufficient to carry the load, including the weight of the accompanying cables. The support bars and brackets are specifically engineered to compensate for extra load stress associated with certain applications, such as mobile truck installations.

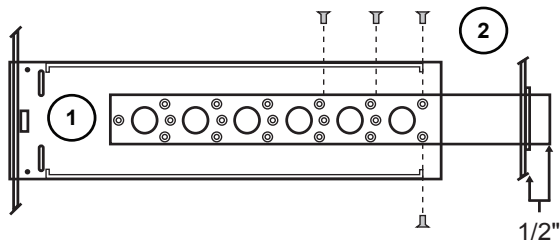

**Figure 1.1** Installing the Frame in an Equipment Rack

**To install the rear support brackets to your frame:**

1. The rear support bars can be attached to the frame in one of the possible positions illustrated in Figure 1.1. Choose the position that suits the cabinet depth that will give approximately 1/2 inch projection beyond the rear vertical mounting rails.
2. Using four screws per bar, fasten one bar to each side of the frame.
3. Mount the frame to the front rails of the rack cabinet using four rack screws fastened through the front mounting flanges.
4. At the rear of the cabinet, slide the bracket slots over the rear of the support bars and secure to the cabinet rear rails with two rack screws each.

**Cabling**

Refer to the *Getting Started Guide* for instructions on connecting all cables to your switcher control panel and frame.

**Control Panel Overview**

The CrossOver 12 and CrossOver 6 control panels offer similar functionality. The CrossOver 12 control panel is equipped with additional source buttons, key control buttons, and a positioner for additional control of wipes and patterns.

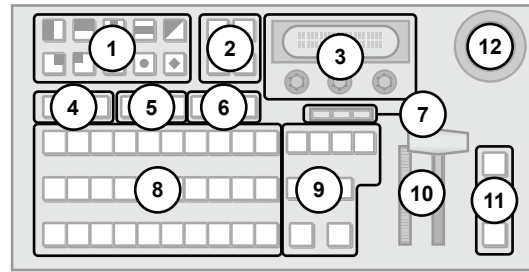

**Figure 1.2** CrossOver 12

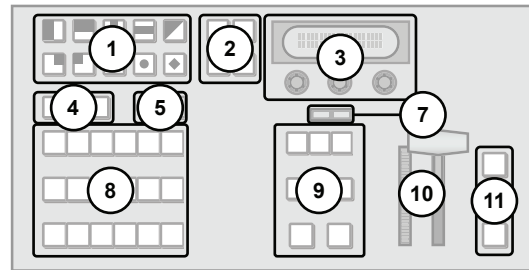
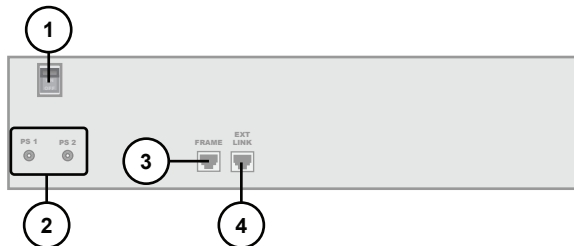

**Figure 1.3** CrossOver 6

1. Pattern Select Buttons
  - Press buttons in the pattern group to select wipe patterns.
2. Menu and Memory Control Buttons
  - Press **MENU** to access the menu system. Press one of the Pattern Select buttons to select the corresponding menu.
  - Press **NEXT** to cycle through the available menus.
  - Press **STORE** and **RECALL** to save and load memory registers.
3. Menu Screen and Knobs
  - Rotate a knob to change the menu option displayed above it.
  - Press the knob to select a menu item.
4. Key Type Buttons
  - Selects the key type for all keys.
  - Assigns Key/Aux bus to Key 1 (CrossOver 6 only).
5. Key Select Buttons
  - Assigns the Key/Aux bus to a keyer when the button is pressed (CrossOver 12 only).
  - Assigns the Key/Aux bus to Key 2 or Aux bus 1 when button is pressed (CrossOver 6 only).
6. Aux Bus Buttons
  - Assigns the Key/Aux bus to the selected Aux bus when button is pressed (CrossOver 12 only).
  - Aux bus assignment is done through the menu interface on CrossOver 6 switchers.

7. On-air LEDs
  - The LEDs light to indicate which keys are on-air.
8. Key/Aux, Program, and Preset Bus
  - Press source buttons on the Key/Aux, Program, or Preset bus to select video sources on each bus.
  - Selected source buttons glow with a user-definable color. Sources that are on-air glow red.
9. Next Transition Area
  - Selects the elements (background, keys) to include in the next transition.
  - Selects the transition type.
  - Performs an automatic transition or a cut.
10. Fader
  - Use the Fader to manually control transitions.
11. Key Transition Shortcut Buttons
  - Performs a transition of the selected key.
12. Positioner
  - Use the positioner to control wipes, borders, washes, and some external devices. (CrossOver 12 only)

## Control Panel Rear Connections Overview

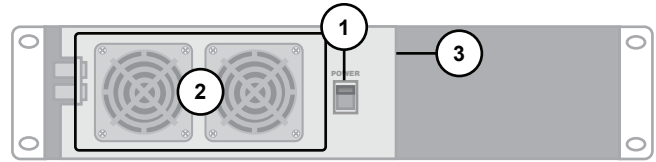

**Figure 1.4** CrossOver 12 and CrossOver 6

1. Power Switch
  - Turns the control panel on and off.
2. Power Connectors (Primary and Redundant)
  - Connects the control panel to the DC power supply.
  - Second power connector is for redundant power supply (optional).
3. Frame Port
  - Connects the control panel to the frame.
4. External Link Port
  - Reserved for future expansion.

## Frame Overview

The frame contains the video processing hardware and provides the inputs and outputs for the switcher. The control panel connects to the frame via the Panel Port on the frame and the Frame Port on the control panel.



**Figure 1.5** CrossOver Frame (Door Removed)

1. Power Switch
  - Turns the frame on and off
2. Cooling Fans
  - The fans provide airflow to cool the electronic components in the frame.
3. USB Port
  - Plug a USB drive into the USB port to load and store memories and to perform software upgrades.

## Frame Rear Connections Overview

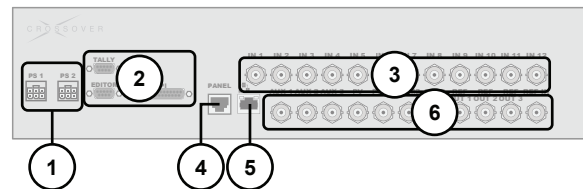

**Figure 1.6** CrossOver 12

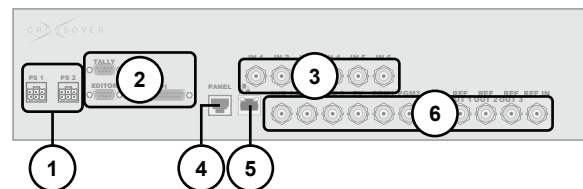

**Figure 1.7** CrossOver 6

1. Power Connectors (Primary and Redundant)
  - Connects the frame to the DC power supply.
  - The second power connector is for redundant power supply (optional).
2. Editor, Tally, and GPI Ports
  - The ports allow your switcher to control tally lights, respond to GPI commands, and be controlled by external editors.

3. Input BNCs
  - 12 or 6 High Definition serial digital video inputs.
4. Panel Port
  - Connects the frame to the control panel.
5. Ethernet Port
  - Enables the switcher to connect to your network.
6. Output and Reference BNCs
  - 2 High Definition serial digital video Program bus outputs.
  - 1 High Definition serial digital video Preset bus output.
  - 3 High Definition serial digital video Aux bus outputs. A fourth Aux bus is shared with the PGM 2 output
  - 1 External Tri-level or Black Burst reference input.
  - 3 Internal Reference outputs.

## Removing the Frame Door

You must remove the frame door to power on/off the frame and to access the USB port. Once you have powered on/off the frame or are finished working with the USB port, replace the frame door to ensure proper airflow through the frame.

**To remove the frame door:**

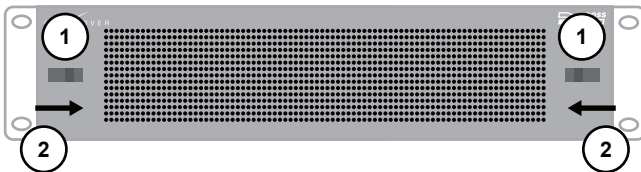

**Figure 1.8** Removing the Frame Door

1. Using both hands, grasp the door tabs.
2. Gently pull the door tabs towards the center of the door, releasing the door from the frame.
3. Pull the door towards you and place it on a clean, flat, static-free surface.

**To attach the frame door:**

1. Using both hands, slide the door onto the frame ensuring that the door tabs engage sides of the frame.
2. Pull and release the door tabs to ensure the frame door is securely attached to the frame.

## Menu System

There are two ways to access the menu system:

- Pressing **MENU**
- Using Auto-follow

**To access a menu using the MENU button:**

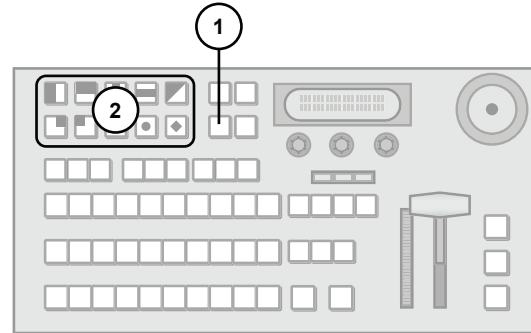

1. Press **MENU**. The Wipe Pattern buttons illuminate.
2. Press a Wipe Pattern button to select the corresponding menu (menu names are printed beneath the Wipe Pattern buttons).

## Auto-Follow

Auto-follow displays the menu for a selected function when the button for that function is pressed. Auto-follow is always active — when you press any button on the control panel that has a corresponding menu, the menu is automatically displayed.

## External Devices and Auto-Follow

When you have external devices connected to your switcher, you can quickly access the device control menu even when the menu system auto-follows to another menu. Pressing a button with an auto-follow menu a second time displays the device control menu if an input source assigned to that device is active. Repeatedly pressing the button toggles between the auto-follow menu and the device-control menu.

**For More Information on...**

- external device control, refer to the section “Device Control” on page 4-11.

## Menu Navigation

Some menus have multiple pages. When the **NEXT** button is lit, multiple menu pages exist. Press **NEXT** to move to the next menu page. Press and hold **NEXT** and then press **MENU** to move to the previous menu page.

Some menus contain sub-menus. Press the knob corresponding to the sub-menu to access it. Press and hold the **NEXT** button and then press the **RECALL** button to return from the sub-menu.

If you wish to return to the first page of a top-level menu, Press and hold the **NEXT** button and then press the **STORE** button.

**Note:**

- You can exit the menu system by pressing any button other than a Wipe Pattern or source button while the menu system is active.

## Knobs

The control panel has three continuously rotatable pushbutton knobs located below the display screen. The knobs are used to select and alter menu options.

**To use the knobs:**

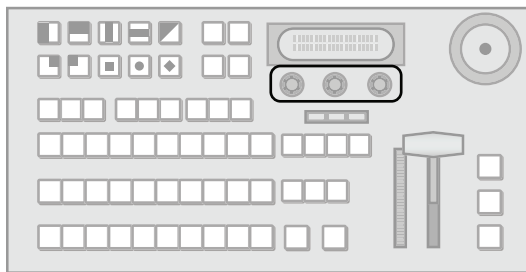

- Rotate the knob to adjust the corresponding value.

**To default a value using the knobs:**

- Double-press a knob to default the value currently associated with that knob.

## Buttons

The buttons illuminate to indicate one of four states:

- **Glow** — When a button on the board is lit with the Panel Glow color, it is in a resting state. All buttons are lit with the Panel Glow color unless selected, turned on, in use, or on-air.
- **On-air** — Source buttons corresponding to on-air sources are red.
- **Menu** — A button is green when the associated menu is displayed.
- **On/Selected** — Several buttons are On/Off buttons. If the button feature is turned off, it is lit with the Panel Glow color. If the button feature is turned on, the button is lit with a brighter shade of the Panel Glow color.

**For More Information on...**

- adjusting the panel glow, refer to the section “Customizing the Panel Glow” on page 2-9.

## Button Inserts

Insert films can be installed into most switcher buttons. Insert films allow you to label specific source buttons, control buttons, or replace the default button names with those of a different language.

### Installing Your Own Insert Films

All inserts must be cut to the dimensions indicated for small (1) or large (2) buttons.

- ★ *Using insert films that do not meet the recommended criteria may damage the button cap and diffuser.*

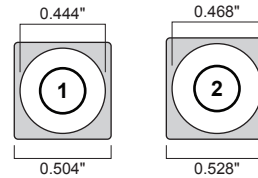

**Figure 1.9** Insert Sizing

**To install switcher button inserts:**

1. Remove the Cap Assembly (1) from the Switch Assembly (2) by grasping it firmly and pulling away from the control panel surface.

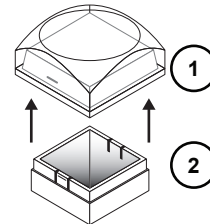

2. Remove the Lens (1) from the Diffuser (2) using a common end micro screwdriver.

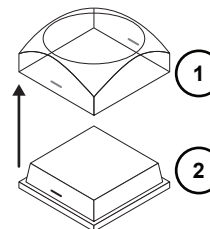

3. Place the Insert Film (2) into the Lens (1) so the readable side is facing up. The notches on the sides of the Lens must be at the sides of the text on the Insert Film.

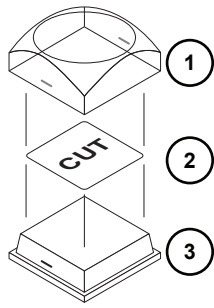

4. Aligning the notches on the sides of the Lens (1) and Diffuser (3), press the Lens and Diffuser together until they click.
5. Aligning the notches on the sides of the Cap Assembly (1) to the tabs on the side of the Switch Assembly (2), press Cap Assembly down onto the Switch Assembly with a rolling motion until they click together.

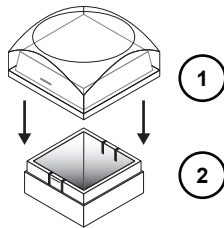

## Shift

Shifting allows access to the secondary sources for each source button.

**To shift a bus and access the secondary sources:**

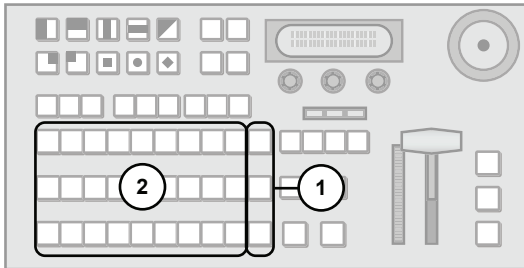

1. Press and hold **SHIFT**.
2. Press the required source button to access the secondary source.

## Fader

The Fader is used to manually perform a wipe or dissolve transition. Move the Fader handle from one limit to the other to perform a transition.

## Transitions

The progress of the transition is shown on the Progress Bar to the left of the Fader handle. As the Fader handle moves from one limit to the other, the Progress Bar indicates the progress of the transition.

## Positioner

The CrossOver 12 has a joystick positioner for positioning wipes, patterns, washes, and DVE effects. The CrossOver 6 does not have a positioner.

## Selecting Colors

Functions such as mattes, and Panel Glow have options for adjusting the appearance of a selected color. Individual adjustments for colors are:

- Luminance
- Hue
- Saturation

### Luminance

Luminance affects the brightness of the video signal. Increasing luminance gives a brighter color while decreasing luminance gives a darker color.

### Hue

Hue controls the shade of color (red, yellow, green, blue, etc.).

### Saturation

Saturation affects the vividness of a color. Increasing saturation produces a more vivid color while decreasing saturation produces a less vivid color. Fully decreasing the saturation produces gray.







# Configuration

This chapter describes how to configure your switcher to meet your requirements. Setup and switcher personality options are discussed.

## Reference Type

The switcher supports both external and internal reference types.

**To set the reference type:**

1. If you are using an external reference signal, ensure that it is connected to the **REF IN** input.
2. Press  **MENU**.
3. Press the  **REF Wipe Pattern** button.
4. Press  **NEXT** until **RefSrc** is displayed.
5. Use the  **RefSrc** knob to select the reference source. You can choose from the following:
  - **Ext** — Use an external reference source.
  - **Int** — Use the internal reference generator.
6. Press the  **RefSrc** knob to save the selection.

**Note:**

- If the external reference is lost, the switcher will automatically switch to internal reference.

## Switcher Video Format

There are separate standard definition and multi-definition versions of the switcher.

### Standard Definition Video Formats

Standard definition switchers support the following video formats:

- 480i (4:3 and 16:9) at 59.94Hz
- 576i (4:3 and 16:9) at 50Hz

**Note:**





- 59.94Hz is displayed as 60Hz to save display space.

### Multi-Definition Video Formats

Multi-Definition switchers support the following video formats:

- 480i (4:3 and 16:9) at 59.94Hz
- 576i (4:3 and 16:9) at 50Hz
- 720p at 50 or 59.94Hz
- 1080i at 50 or 59.94Hz

**To change the switcher video format:**

1. Press  **MENU**.
2. Press the  **REF Wipe Pattern** button.
3. Use the  **Format** knob to select the desired video format. You can choose from the following:
  - **480i**
  - **576i**
  - **720p** (Multi-Def switchers only)
  - **1080i** (Multi-Def switchers only)
4. Use the  **Freq** knob to select the desired frequency. You can choose from the following:
  - **60 Hz** (59.94 Hz)
  - **50 Hz**
5. Press the  **Format** knob to save the selection.

**Note:**

- If you set your switcher to an interlaced video format and an external reference source, ensure that you use an interlaced external reference signal.
- The 480i video format is locked to 59.94 Hz.
- The 576i video format is locked to 50 Hz.

## Format Conversion and Frame Sync

The switcher has four input format converter / frame synchronizer (FCFS) channels that can be used for the following:

- Converting incoming video to the current switcher video format. The format converters can convert input video from many formats to the current switcher video format.
- Correcting mis-timed or drifting input signals in any of the supported video formats. The frame

synchronizers can not completely correct badly formatted video streams, mis-timed switches, signal dropouts, or similar issues.

## Understanding Aspect Ratio Conversion

Converting between video formats often requires converting between aspect ratios. Your switcher supports the following aspect ratio conversion methods:

- **Full** — The video signal is scaled disproportionately to fill the display of the new aspect ratio. Aspect distortion occurs as the image is stretched/compressed to fit in the new aspect ratio.

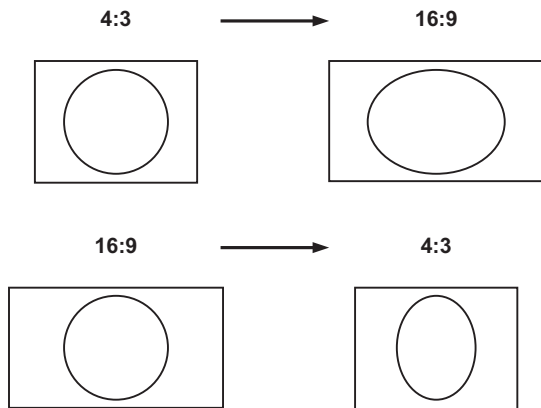

Figure 2.1 Full Aspect Ratio Conversion

- **Zoom** — The central portion of the video signal is zoomed to fill the display of the new video format. No aspect distortion is introduced but the edges of the video signal may be cropped.

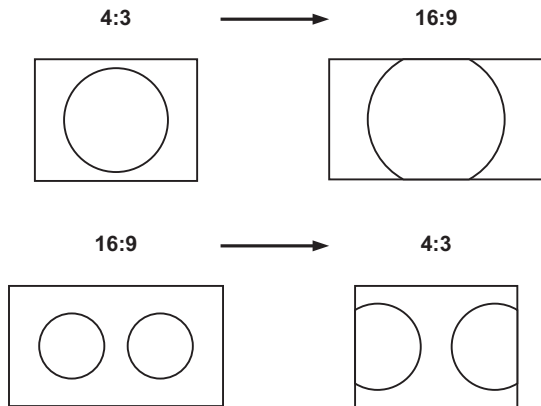

Figure 2.2 Zoom Aspect Ratio Conversion

- **Letterbox** — Black bars are added to the top and bottom of a 16:9 image to display correctly in a 4:3 video format.

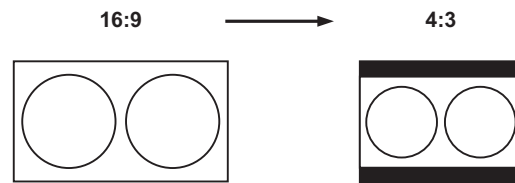

Figure 2.3 Letter Box Aspect Ratio Conversion

- **Pillarbox** — Black bars are added to the right and left of a 4:3 image to display correctly in a 16:9 video format.

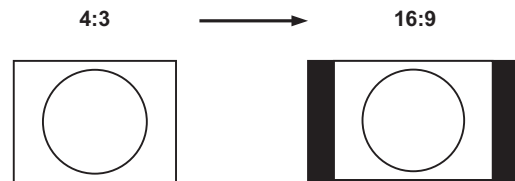

Figure 2.4 Pillar Box Aspect Ratio Conversion

## Assigning FCFS Channels

FCFS channels are assigned to either specific inputs or bus-pairs. Each bus-pair requires two FCFS channels. The bus-pairs are as follows:

- PGM – Preset buses
- Key 1 Video – Key 1 Alpha buses
- Key 2 Video – Key 2 Alpha buses
- Key 3 Video – Key 3 Alpha buses (CrossOver 12 only)
- Aux 1 – Not paired
- Aux 2 – Not paired
- Aux 3 – Not paired

FCFS channels maintain separate settings for different switcher video formats. This lets you change between switcher video formats without losing FCFS channel configurations.

### Note:

- Using an FCFS channel creates a one frame delay for the input video being processed.
- Using an FCFS channel strips embedded audio data from the video signal. Ensure that no FCFS channels are assigned to any input or bus you are using with external audio mode. Refer to the section “CrossOver CleanSwitch” on page 2-8 for details on external audio mode.

### To assign an FCFS channel:

1. Press **MENU** MENU.
2. Press the **REF** Wipe Pattern button.
3. Press **NEXT** NEXT until **Fcfs** is displayed.

4. Use the **Fcfs** knob to select the FCFS channel you wish to assign.
5. Press the **Fcfs** knob to display the **FCFS** menu.
6. Use the **Fcfs1-4** knob to assign the FCFS channel. You can choose from the following:
  - **Off** — The FCFS channel is not assigned.
  - **Input** — The FCFS channel is assigned to a single input.
  - **Bus** — The FCFS channel is assigned to all inputs on a specific bus.

#### Configuring FCFS Channels in Input Mode

Input mode locks a specified FCFS channel to a specific input. Table 2.1 lists the input video formats you can convert to the specified switcher video format.

**Table 2.1 Format Conversions for Input Mode**

Switcher Video Format	Allowable Input Formats
1080i / 59.94Hz	480i, 720p / 59.94Hz
1080i / 50Hz	576i, 720p / 50Hz
720p / 59.94Hz	—
720p / 50Hz	—
480i / 59.94Hz	480i (aspect ratio conversion), 720p, 1080i / 59.94Hz
576i / 50Hz	576i (aspect ratio conversion), 720p, 1080i / 50Hz

#### To configure an FCFS channel set to Input mode:

1. Assign an FCFS channel to a specific input.
2. Use the **Input** knob to select which input the FCFS channel is assigned to.
3. Use the **Frmng** knob to set the aspect ratio conversion mode. You can choose from the following:
  - **Full** — The video signal is scaled disproportionately to fill the display of the new aspect ratio. Aspect distortion occurs as the image is stretched/compressed to fit in the new aspect ratio.
  - **Zoom** — The central portion of the video signal is zoomed to fill the display of the new

video format. No aspect distortion is introduced.

- **LtrBx** — Black bars are added to the top and bottom of a 16:9 image to display correctly in a 4:3 video format.
- **PllrBx** — Black bars are added to the right and left of a 4:3 image to display correctly in a 16:9 video format.

4. Press the **Fcfs1-4** knob to save your changes.
5. Press the **Confirm** knob to commit the change and exit the **FCFS** menu. Press the **Cancel** knob to return to the **FCFS** menu for further editing.

#### For More Information on...

- Assigning an FCFS channel, refer to the section “Assigning FCFS Channels” on page 2-2.

#### Configuring FCFS Channels in Bus Mode





Bus mode locks a specified FCFS channel to a specific bus-pair.

**Table 2.2 Format Conversions for Bus Mode**

Switcher Video Format	Allowable Input Formats
1080i / 59.94Hz	480i, 720p / 59.94Hz
1080i / 50Hz	576i, 720p / 50Hz
720p / 59.94Hz	—
720p / 50Hz	—
480i / 59.94Hz	480i (aspect ratio conversion), 720p, 1080i / 59.94Hz
576i / 50Hz	576i (aspect ratio conversion), 720p, 1080i / 50Hz

#### To configure an FCFS channel set to Bus mode:

1. Assign an FCFS channel to a specific bus.
2. Use the **Bus** knob to select which bus the format converter / frame synchronizer is assigned to.
3. Use the **2ndCh** knob to select the FCFS channel to assign to the paired bus.
4. Press **NEXT**.

5. Use the  **Fringing** knob to set the aspect ratio conversion mode. You can choose from the following:
  - **Full** — The video signal is scaled disproportionately to fill the display of the new aspect ratio. Aspect distortion occurs as the image is stretched/compressed to fit in the new aspect ratio.
  - **Zoom** — The central portion of the video signal is zoomed to fill the display of the new video format. No aspect distortion is introduced.
  - **LttrBx** — Black bars are added to the top and bottom of a 16:9 image to display correctly in a 4:3 video format.
  - **PllrBx** — Black bars are added to the right and left of a 4:3 image to display correctly in a 16:9 video format.
6. Press  **NEXT**.
7. Press the  **Fcfs1-4** knob to save your changes.
8. Press the  **Confirm** knob to commit the change and exit the **FCFS** menu. Press the  **Cancel** knob to return to the **FCFS** menu for further editing.

**Note:**

- If one FCFS channel in a bus-pair is turned off, the paired FCFS channel is also turned off.
- The switcher is set to switch on the first field when using Bus mode.
- If a video format not compatible with the currently defined conversion is used, the video image is frozen with the last successfully processed image frame.

**For More Information on...**

- switch on Field/Frame settings, refer to the section “Field Switch Selection” on page 2-12.
- assigning an FCFS channel, refer to the procedure “To assign an FCFS channel:” on page 2-2.
- switcher video formats, refer to the section “Switcher Video Format” on page 2-1.

## Output Reference Sync









The switcher has three reference outputs that can be configured independently.

## Setting the Output Reference Sync

If you are using one of the output references to time external devices, ensure that they are connected to the appropriate **REF OUT 1**, **REF OUT 2**, or **REF OUT 3** outputs.

Different applications require different output reference formats and delay settings. Consult a facility engineer for assistance in configuring these settings.

**To set the output reference sync:**

1. Press  **MENU**.
2. Press the  **REF Wipe Pattern** button.
3. Press  **NEXT** until **OSync** is displayed.
4. Use the  **OSync** knob to select the reference output you wish to configure. You can choose from the following:
  - **OSync 1** — Configure reference output 1.
  - **OSync 2** — Configure reference output 2.
  - **OSync 3** — Configure reference output 3.
5. Press the  **OSync** knob to display the **Output Sync** menu.
6. Use the  **OSync1-3** knob to set the output reference format. You can choose from the following:
  - **Off** — No output reference signal is generated.
  - **NTSC/PAL** — Reference format is set to standard definition.
  - **720p** — Reference format is set to 720p.
  - **1080i** — Reference format is set to 1080i.
7. Use the  **Mode** knob to configure the different delay settings for the selected output reference formats. You can choose from the following:
  - **V** — Configure vertical delay (lines).
  - **H** — Configure horizontal delay (pixels).
  - **F** — Configure frame delay (frames) (NTSC/PAL output reference format only).
8. Use the  **Value** knob to set the selected delay value.
9. Press the left knob to save your changes.
10. Press the  **Confirm** knob to commit the change and exit the **Output Sync** menu. Press

the  **Cancel** knob to return to the **Output Sync** menu for further editing.





**Note:**

- You can reset the Output Reference Sync by pressing the **Reset** knob on the second page of the **Output Sync** menu.

### Setting Analog Output Reference Color Framing

When the output reference (OSync) is set to an analog format (NTSC/PAL), the color framing in the subcarrier can be synced to the color framing of the input reference. The input reference must also be set to an analog format.

**To Sync Output Reference Color Framing:**

1. Press  **MENU**.
2. Press the  **REF** Wipe Pattern button.
3. Press  **NEXT** >  **NEXT**.
4. Use the  **ColFrm** knob to turn syncing of color framing on or off.
  - **NoSync** — Select this option to not have color framing synced in the output reference synced to the color framing in the input reference.
  - **Sync** — Select this option to have color framing synced in the output reference synced to the color framing in the input reference.





**Note:**



- Jitter on the color framing of the reference output causes the analog reference output to reset in an attempt to re-sync.

### Aspect Ratio

The switcher supports both 4:3 and 16:9 aspect ratios when running in the 480i/576i video format.

**To change the aspect ratio:**

1. Press  **MENU**.
2. Press the  **REF** Wipe Pattern button.
3. Press  **NEXT** until Aspect is displayed.
4. Use the  **Aspect** knob to select the desired aspect ratio. You can choose from the following:
  - **4:3**
  - **16:9**

5. Press the  **Aspect** knob to save your selection.
6. Press the  **Confirm** knob to commit the change. Press the  **Cancel** knob to discard the change and return to the previous setting.

**Note:**

- The aspect ratio is locked to 16:9 when operating in 720p or 1080i video formats.

### Ancillary Data



Ancillary data is information such as closed captioning or embedded audio. The switcher can be configured to pass this data or strip it from the output video. The following modes are available (each mode differs depending on the video format of the switcher as shown in Table 2.3):

- **Normal Strip** — Ancillary data is stripped from both the horizontal and vertical blanking.
- **Normal Pass** — Ancillary data in the horizontal and vertical blanking is passed unmodified.
- **Long Strip** — Ancillary data is stripped (and replaced with black) from both the horizontal and vertical blanking as well as some lines of active picture.
- **Long Pass** — Ancillary data in the horizontal and vertical blanking and some lines of active picture are passed unmodified. This ensures data, such as timecodes and closed captioning, remain intact (480i/576i video format only).

**Table 2.3 Vertical Ancillary Data**

Video Format	Last Line of Vertical Ancillary Data	
	Normal Pass/Strip	Long Pass/Strip
480i	19	21
576i	22	24
720p	25	25
1080i	20	20

**To configure ancillary data parameters:**

1. Press  **MENU**.
2. Press the  **SYSTEM** Wipe Pattern button.
3. Press  **NEXT** until **Ancly** is displayed.

4. Use the  **Anclry** knob to select an ancillary data parameters. You can choose from the following:
  - **N Strip** — Removes ancillary data from the video signal.
  - **N Pass** — Passes ancillary data without modification.
  - **L Strip** — Removes ancillary data and the first few lines of picture from the video signal.
  - **L Pass** — Passes ancillary data and the first few lines of picture.

## Input BNC Configuration

Many video sources have an associated video source that contains alpha information. You must configure the switcher to use the correct alpha source. Once you associate a video and alpha source, they are linked and used for Auto-Select keying.

Alpha sources are designated as shaped or linear (unshaped). Shaped sources convert partial transparency to either fully transparent or fully opaque, giving the video signal well-defined edges.





Linear (unshaped) sources use the full range of transparency in the alpha channel to give smooth transitions between transparent and opaque areas. Use linear if you are unsure which setting to use.

Inputs can also be assigned to external devices that you are controlling from your switcher. Refer to the *Ross Video External Device Setup Sheet* for your device connection and configuration information.

### For More Information on...

- Auto-Select keys, refer to the section “Keying Overview” on page 3-4.

### To associate video and alpha inputs:

1. Press  **MENU**.
2. Press the  **CONFIG** Wipe Pattern button.
3. Press the  **Input** knob to display the **Input** menu.
4. Use the  left knob to select the input you wish to configure.

5. Use the  **Alpha** knob to select the desired input that will provide the alpha (transparency) signal. You can choose from the following:
  - **None** — Do not use an associated alpha signal.
  - **Lin1 - Lin12** — The selected input is used as a linear (unshaped) alpha source.
  - **Shpd1 - Shpd12** — The selected input is used as a shaped alpha source.

**Table 2.4 Default Alpha Channel Mappings**

Input	Default Alpha Input
<b>CrossOver 6</b>	
5	6
<b>CrossOver 12</b>	
9	11
10	12

6. If you are using standard definition sources, use the  **SD ASP** knob to select the aspect ratio of the video signal. You can choose from the following:
  - **16:9**
  - **4:3**

### For More Information on...



- fine-tuning the Auto-Select Key features, refer to the section “Advanced Keying” on page 4-3.

## Clean Feed

Clean Feed provides a second program output that is derived from a different location than the standard program output. Using the Clean Feed allows you to remove particular keys without affecting the primary program output. Typical applications are:

- Multilingual and live-to-tape productions
- Recording shows for later airing without overlaid graphics

### To configure Clean Feed:

1. Press  **MENU**.
2. Press the  **SYSTEM** Wipe Pattern button.

- Use the **CLEAN** knob to select where in the output stream the Clean Feed is derived. You can choose from the following:
  - Key 1** — Clean Feed output is taken before any keys are added.
  - Key 2** — Clean Feed output is taken after Key 1 but before Key 2 or 3 is added.
  - Key 3** — (CrossOver 12 only) Clean Feed output is taken after Key 1 and 2 but before Key 3 is added.

**Note:**

- There is no physical Clean Feed output. The Clean Feed signal is available from any Aux bus.
- Recalling a memory register using Memory AI may cause the Clean Feed output to look different than expected. Memory AI allows key elements to be recalled to other keys than originally resulting in different key layering.

**For More Information on...**

- Accessing the Clean Feed output on an Aux bus, refer to the section “Selecting a Special Source on an Aux Bus” on page 4-6.
- Memory AI, refer to the section “Recalling Memory Registers” on page 5-4.
- resource sharing, refer to the section “Resource Sharing” on page 2-11.

## MultiViewer

The MultiViewer™ allows you to view ten video sources from a single output BNC. Any video source on the switcher, including Program, Preview, and Media-Store channels, can be assigned to any box on the MultiViewer.

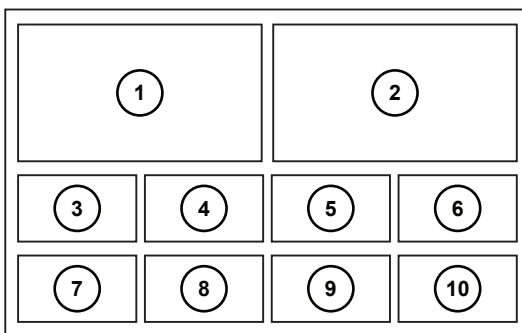

**Figure 2.5** MultiViewer Layout

**To enable or disable MultiViewer:**

- Press **MENU**.
- Press the **SYSTEM** Wipe Pattern button.

- Press the **MultiViewer** knob to display the **MultiViewer** menu.
- Use the **Output** knob to select an output to configure for MultiViewer layout display.
  - Pgm2** — Configure the Program 2 output.
  - Preview** — Configure the Preview output.
- Use the **MView** knob to enable or disable MultiViewer display on the selected output.
  - On** — The MultiViewer layout is displayed on the selected output.
  - Off** — The MultiViewer layout is not displayed on the selected output.
- Use the **Transp** knob to set the transparency of the MultiViewer source labels.
- Press **NEXT > NEXT**.
- Use the **AncSrc** knob to select the ancillary data that is included in the MultiViewer output.
  - PV** — Select this option to include the ancillary data from Preview with the MultiViewer output.
  - PGM** — Select this option to include the ancillary data from Program with the MultiViewer output.

**Note:**

- The MultiViewer layout is configured independently for each output.
- The outputs can be configured to display the MultiViewer layout simultaneously.
- If you turn on the MultiView for Pgm2, Aux 4 is turned off and the MultiView output is fed out of that output BNC instead.

**For More Information on...**

- ancillary data, refer to the section “Ancillary Data” on page 2-5.

**To assign sources to the MultiViewer display:**

- Press **MENU**.
- Press the **SYSTEM** Wipe Pattern button.
- Press the **MultiViewer** knob to display the MultiViewer menu.
- Press **NEXT**.
- Use the **Box** knob to select a box on the MultiViewer display. Refer to Figure 2.5 for the locations of the boxes.

- Use the **In/Out** knob to select a source to display in the box. You can choose from the following:
  - PGM** — Program bus output
  - PV** — Preset bus output
  - 1-12** (1-6 for CrossOver 6) — Source inputs
  - M1-4** — Media-Store channels

**Note:**

- Media-Store channels 3 and 4 are only available when the Media-Store mode is set to **Dual**, **Swish**, or **Swish+**.
- Inputs assigned to boxes 3-10 are displayed with a red border when they are on-air. A green border is displayed when the input is selected on the Preset bus.
- Boxes 1 and 2 do not have colored borders.

**For More Information on...**

- setting the Media-Store mode, refer to the section “Media-Store Modes” on page 6-1.

## CrossOver CleanSwitch

CrossOver CleanSwitch allows you to perform high-quality transitions between video signals with embedded audio streams. All 16 embedded audio channels are passed through the switcher.

The setup consists of your switcher, an openGear DFR-8300 series frame, and an MDK-111A-Lite.

Refer to your CrossOver CleanSwitch documentation for details on cabling and transition behavior.

**To configure your switcher for External Audio mode:**

- Press **MENU**.
- Press the **SYSTEM** Wipe Pattern button.
- Press **NEXT** until **Ext Audio** is displayed.
- Press the **Ext Audio** knob to display the **External Audio** menu.
- Use the **ExtAud** knob to enable or disable external audio switching.
- Use the **Type** knob to select the type of audio transition that is performed. You can choose from the following:
  - V-Fade** — Audio from the source going off-air is faded to no volume and then the

audio from the source going on-air is faded to full volume.

- X-Fade** — Audio from the source going on-air is simultaneously faded up to full volume while the audio from the source going off-air is faded to no volume.

- Press **NEXT** until **IPAddr** is displayed.
- Use the **Field** knob to select the various fields in the IP address.
- Use the **Value** knob to modify the field values and enter the IP address of your MDK-111A-Lite card.
- Press the **IPAddr** knob to save the IP address.
- Press the **Confirm** knob to commit the change and exit the menu. Press the **Cancel** knob to return to the External Audio menu for further editing.

**Note:**

- Using Frame Sync strips embedded audio data. Ensure that Frame Sync is turned off for any input or bus you are using with external audio mode. Refer to the section “Format Conversion and Frame Sync” on page 2-1 for details.

## IP Address

The switcher is equipped with an Ethernet port to allow remote access. By default, the switcher uses DHCP to automatically obtain an IP address. You can manually set an IP address, network mask, and default gateway if your network does not have a DHCP server.





**Note:**

- You do not need to connect your switcher to a network for it to function.













**To configure a DHCP IP address for your switcher:**

- Ensure your switcher is connected to your network via the ethernet port.
- Press **MENU**.
- Press the **SYSTEM** Wipe Pattern button.
- Press **NEXT** until **IP Addr** is displayed.
- Press the **IP Addr** knob to display the **IP Address** menu.



6. Press the  **Edit** knob.
7. Use the  **IPMode** knob to select **DHCP**.
8. Press the  **IPMode** knob to save your selection.
9. Press the  **Reboot** knob to commit the change and reboot the switcher. Press the  **Cancel** knob to discard the change and return to the previous setting.

#### To configure a static IP address for your switcher:

1. Ensure your switcher is connected to your network via the ethernet port.
2. Press  **MENU**.
3. Press the  **SYSTEM** Wipe Pattern button.
4. Press  **NEXT** until **IP Addr** is displayed.
5. Press the  **IP Addr** knob to display the **IP Address** menu.
6. Press the  **Edit** knob.
7. Use the  **IPMode** knob to select **Static**.
8. Press  **NEXT** until **IPAddr** is displayed.
9. Use the  left knob to select the data to configure. You can choose from the following:
  - **IPAddr** — Configure the IP address (configure this first).
  - **Mask** — Configure the network mask.
  - **Gatwy** — Configure the default gateway.
10. Use the  **Field** knob to select the fields in the address.
11. Use the  **Value** knob to modify the field value.
12. Repeat steps 9 to 11 for **Mask** (network mask), and **Gatwy** (network gateway).
13. Press the  left knob to save all network settings.
14. Press the  **Confirm** knob or the **Reboot** knob to commit the changes. Press the  **Cancel** knob to discard the changes and return to the previous setting.

#### Note:







- If you are switching from DHCP to static IP mode, a reboot is required.

## Bus Map

You can re-map the source buttons on your switcher if you wish to customize the order of inputs and Media-Store channels on each bus row. Each source button can have two inputs assigned (a standard input and a shifted input).

Each bus row shares the same button mapping.

#### To modify the Bus Map:

1. Press  **MENU**.
2. Press the  **CONFIG** Wipe Pattern button.
3. Press the  **BusMap** knob to display the **Bus Map** menu.
4. Use the  **XptBtn** knob to select the source button to modify.
5. Use the  **Input** knob to select the desired input source or Media Store channel. Select **Shift** if you wish this button to be a **Shift** button.
6. Use the  **Shift** knob to select the desired input source or Media Store channel assigned to the shifted state of the selected source button.





## Switcher Personality



The switcher has customizable features that allow you to tailor operation to your personal preferences.

### Customizing the Panel Glow

Panel buttons are set to a glow color which is used when the button is not selected. This glow color can be customized.

#### To customize the Panel Glow color:

1. Press  **MENU**.
2. Press the  **USER** Wipe Pattern button.
3. Press the  **Scheme** knob to display the **Color Scheme** menu.
4. Use the  **HUE** knob to adjust the Panel Glow hue.

5. Use the  **SAT** knob to adjust the Panel Glow saturation.
6. Use the  **LUM** knob to adjust the Panel Glow luminance.

**Note:**

- It is not recommended to set the Panel Glow color to red. Red indicates a source is on-air.









**For More Information on...**

- hue, saturation, and luminance, refer to the section “Selecting Colors” on page 1-6.

## Saving Color Schemes

You can save a custom Panel Glow color scheme so that it may be recalled as needed.





**To save a custom Panel Glow color scheme:**





1. Modify the Panel Glow to obtain the desired appearance.
2. Press  **MENU**.
3. Press the  **USER** Wipe Pattern button.
4. Press the  **Scheme** knob to display the **Color Scheme** menu.
5. Press  **NEXT** until **Save** is displayed.
6. Use the  **Save** knob to select the custom scheme you wish to save.
7. Press the  **Save** knob to save the color scheme.
8. Press the  **Confirm** knob to commit the save (if there was a color scheme saved to the selected custom scheme, it is overwritten). Press the  **Cancel** knob to cancel the save.

## Loading Color Schemes

You can load a custom color scheme or one of the preset color schemes that are included on your switcher.

**To load a custom Panel Glow color scheme:**

1. Press  **MENU**.
2. Press the  **USER** Wipe Pattern button.
3. Press the  **Scheme** knob to display the **Color Scheme** menu.
4. Press  **NEXT** until **Load** is displayed.





5. Use the  **Load** knob to select the color scheme you want to load. You can select from a list of presets or one of the custom color schemes you have previously saved.
6. Press the  **Load** knob to load the color scheme.
7. Press the  **Confirm** knob to commit the load. Press the  **Cancel** knob to cancel the load.

## Power-Save Mode

The switcher goes into a Power-Save mode after a user-defined amount of time (20 minutes by default) without user interaction. Touching any control will wake the switcher. Any functionality associated with the touched control is ignored until the unit is active and all lights and display are turned on.

During Power-Save mode, video related hardware is not affected and video signals are still passed through the switcher.

**To configure the power-save timeout:**

1. Press  **MENU**.
2. Press the  **PERS** Wipe Pattern button.
3. Press the  right knob to set the switcher power-save behavior. You can choose from the following:
  - **PwrSve** — All buttons and the menu display turn off. The switcher conserves as much power as possible without affecting on-air video.
  - **Sleep** — The menu display turns off. Buttons light and slowly fade in a raindrop pattern.
4. Use the  right knob to set the power-save timeout (in minutes). You can select a value from 0 (off) to 999 minutes.

## Transition Rate Units

You can select the units used to specify durations for various video transitions. Choose the units that you are most comfortable working with.

**To select the units for switcher transitions:**





1. Press  **MENU**.
2. Press the  **PERS** Wipe Pattern button.

3. Use the  **Rate** knob to select the units used to specify switcher transition rates. You can choose from the following:
  - **Frames** — Switcher transitions are specified in frames.
  - **Secnds** — Switcher transitions are specified in seconds.

### Double-Press Rate

You can set the double-press rate of the switcher to suit your preference. Setting a fast rate requires you to double-press the knobs in quick succession in order to be recognized as a double-press. Setting a slow rate allows more time between presses but may register two single presses as a double-press.



#### To set the switcher double press rate:





1. Press  **MENU**.
2. Press the  **PERS** Wipe Pattern button.
3. Press the  **DbIPrs Speed** knob.
4. Double-press the  middle knob at a rate you feel is comfortable. This defines the double-press rate.
5. Press  **MENU** to save the setting.

### Resource Sharing

The switcher can use one Chroma Key and two channels of DVE simultaneously. You can specify how the Chroma Key is shared between keys and the DVE resources are shared between keys and the transition area on your switcher.

#### To specify resource sharing:



1. Press  **MENU**.
2. Press the  **SYSTEM** Wipe Pattern button.
3. Press the  **Rsrc Mode** knob to display the **Resource Mode** menu.

4. Use the  **ChrKey** knob to select how the Chroma Key resource is shared between keys. You can choose from the following:
  - **KEY1** — The Chroma Key is locked to Key 1. Only Key 1 can display a Chroma Key.
  - **KEY2** — The Chroma Key is locked to Key 2. Only Key 2 can display a Chroma Key.
  - **KEY3** (CrossOver 12 only) — The Chroma Key is locked to Key 3. Only Key 3 can display a Chroma Key.
  - **FLOAT** — The Chroma Key can be used by any key. If another Chroma Key is on-air, you are prompted to capture the Chroma Key resource for the new key.
  - **ASK** — The Chroma Key can be used by any key. If another Chroma Key is in-use (on or off-air), you are prompted to convert the original Chroma Key to an Auto-Select Key, take it off-air, and use the Chroma Key resource for the new key.
5. Press the  **ChrKey** knob to select the Chroma Key sharing mode.
6. Use the  **DVE1** knob to select how the first DVE resource is shared between keys and the transition area. You can choose from the following:
  - **KEY1** — DVE channel 1 is locked to Key 1.
  - **KEY2** — DVE channel 1 is locked to Key 2.
  - **KEY3** (CrossOver 12 only) — DVE channel 1 is locked to Key 3.
  - **TRANS** — DVE channel 1 is locked to performing transitions.
  - **FLOAT** — DVE channel 1 can be used by any key or to perform a transition. If two channels of DVE are in use and on-air and you attempt to use a DVE channel, you are prompted to steal one of the DVE channels.
  - **ASK** — DVE channel 1 can be used by any key or to perform a transition. If two channels of DVE are in use (on or off-air) and you attempt to use a DVE channel, you are prompted to steal one of the DVE channels.
7. Press the  **DVE1** knob to select the sharing mode for the first DVE resource.
8. Use the  **DVE2** knob to select how the second DVE resource is shared between keys

and the transition area. You can choose from the following:

- **KEY1** — DVE channel 2 is locked to Key 1.
- **KEY2** — DVE channel 2 is locked to Key 2.
- **KEY3** (CrossOver 12 only) — DVE channel 2 is locked to Key 3.
- **TRANS** — DVE channel 2 is locked to performing transitions.
- **FLOAT** — DVE channel 2 can be used by any key or to perform a transition. If two channels of DVE are in use and on-air and you attempt to use a DVE channel, you are prompted to capture one of the DVE channels.
- **ASK** — DVE channel 2 can be used by any key or to perform a transition. If two channels of DVE are in use (on or off-air) and you attempt to use a DVE channel, you are prompted to capture one of the DVE channels.

9. Press the  **DVE2** knob to save your selection.

10. Press the  **Confirm** knob to commit the change. Press the  **Cancel** knob to cancel the change.

#### For More Information on...

- creating and using Chroma Keys, refer to the section “UltraChrome Chroma Key” on page 3-6.
- creating and using DVE Keys, refer to the section “DVE Key” on page 3-10.
- performing DVE transition, refer to the section “DVE Transitions” on page 3-2.

#### Chroma Key Resource Capturing

Capturing a Chroma Key resource for a new key causes the following to occur:

- The current Chroma Key is converted to an Auto-Select Key
- If the current Chroma Key is on-air, it is taken off-air.

#### DVE Resource Capturing

Capturing a DVE resource for a new key or transition takes the DVE resources from the following sources in order of availability:

- **Transition area** (if a DVE transition is not in progress).
- **Off-air DVE key** (highest key resource is taken first).
- **On-air DVE key** (current DVE Key is converted to an Auto-Select key and taken off-air).
- **Transition area** (if a DVE transition is in progress. The transition is converted to a dissolve transition).





#### Field Switch Selection

The field switch selection feature allows you to select when the switcher triggers a transition from one video source to the next when you are running in an interlaced video format. Each interlaced video frame is composed of an odd field and an even field. You can specify that transitions are initiated on:

- even fields only
- odd fields only
- either even or odd fields

If you are running in a progressive scan video format, setting your switcher to transition on even or odd fields will cause the switcher to only allow transitions on every second frame.

#### To set when the switcher initiates transitions:

1. Press  **MENU**.
2. Press the  **SYSTEM** Wipe Pattern button.
3. Press  **NEXT** until **FldSw** (**FrmSw** if you are using a progressive scan video format) is displayed.
4. Use the  **FldSw** (**FrmSw** if you are using a progressive scan video format) knob to select when transitions are initiated. You can choose from the following:
  - **F1** — Field 1 (Odd Field) transitions are initiated on odd fields.
  - **F2** — Field 2 (Even Field) transitions are initiated on the even fields.
  - **BOTH** — Transitions can be initiated on either even or odd fields or frames.
5. Press the  **FldSw** (**FrmSw** if you are using a progressive scan video format) knob to commit the selection.

**Note:**

- If you are using Format Conversion or Frame Sync (FCFS) channels, transitions are locked to **F1**.





**For More Information on...**

- FCFS channels, refer to the section “Format Conversion and Frame Sync” on page 2-1.



## Editor Control

Your switcher can be controlled by external editors using the GVG100 protocol. It can also generate EDL (Edit Decision List) files for use in non-linear editing suites.

**To configure external editor control:**

1. Press  **MENU**.
2. Press the  **PERS** Wipe Pattern button.
3. Press  **NEXT** until **Editor** is displayed.
4. Use the  **Editor** knob to enable or disable external editor control.

**Note:**

- You can view the LTC timecode from the second page of the **Status** menu.
- Refer to the *Ross Video External Device Setup Sheet* for your editor for cabling and configuration information.
- You can quickly turn editor control on or off by pressing and holding the  **MENU** button, and press  **PERS**.

**For More Information on...**







- external editor control, refer to the section “Editor Port” on page 4-17.
- installation and configuration of the TSC-9902 LTC to Serial Converter, refer to your TSC-9902 documentation.
- Live EDL, refer to the section “Live Edit Decision Lists (EDL)” on page 4-7.

## Transition Area Behavior

You can set the behavior of the transition area to suit your needs.

**To configure the Next Transition Area behavior:**









1. Press  **MENU**.
2. Press the  **PERS** Wipe Pattern button.

3. Press  **NEXT** until **Trans Area** is displayed.
4. Press the  **Trans Area** knob to display the **Transition Area** menu.
5. Use the  **Trans** knob to set the behavior of the Next Transition area after a transition is performed. You can choose from the following:
  - **Reset** — The Next Transition area is reset to a background dissolve transition
  - **NotRst** — The Next Transition area is not reset.
6. Use the  **Auto 2** knob to set the behavior when a transition is paused by pressing **AUTO TRANS** during a transition. You can choose from the following:
  - **HitFwd** — The transition pauses. When you resume the transition, it completes as originally set.
  - **HitRev** — The transition pauses. When you resume the transition, the transition proceeds in reverse and the switcher returns to the on-air state it was in before the transition was started.
  - **Rev** — The transition immediately reverses and the switcher returns to the on-air state it was in before the transition was started.
7. Use the  **ARKey** knob to set whether a Key remains or is removed from the Next Transition area after a dedicated key transition is performed. You can choose from the following:
  - **Off** — The Key is removed from the Next Transition area after a dedicated key transition is performed.
  - **On** — The Key remains active in the Next Transition area after a dedicated key transition is performed.
8. Use the  **RIClip** knob to set whether GPI outputs assigned to input sources are triggered before a transition. You can choose from the following:
  - **Force** — GPI outputs assigned to input sources going on-air in a transition are always triggered.
  - **User** — You can choose whether GPI outputs assigned to input sources going on-air in a transition are triggered.

## NEXT button Secondary Function

You can configure a secondary function of the  **NEXT** button allowing it to be used, in conjunction with the Wipe Pattern buttons, to trigger GPI outputs.

**To configure the NEXT button secondary function:**

1. Press  **MENU**.
2. Press the  **PERS** Wipe Pattern button.
3. Press  **NEXT** until **NextBn Func2** is displayed.
4. Press the  **NextBn Func2** knob to display the **Secondary Function** menu.
5. Use the  **Func** knob to select the secondary function for the  **NEXT** button. You can choose from the following:
  - **None** — The  **NEXT** button is not assigned a secondary function.
  - **GPO** — The  **NEXT** button (in combination with the Wipe Pattern buttons) is used to trigger GPI outputs.
6. If you selected **GPO** in the previous step, use the  **Bank** knob to select which GPI output bank you wish to control.

**Note:**

- Only one GPI output bank can be triggered at a time.





**For More Information on...**

- GPI usage and configuration, refer to the section “General Purpose Interface (GPI)” on page 4-14.

## Background Double-Press

The Background Double-Press feature allows you to have a double-press of the **BKGD** button on a **Transition Module** select background and all on-air keyers as part of the next transition.

**To configure the BKGD Double-press behavior:**

1. Press  **MENU**.
2. Press the  **PERS** Wipe Pattern button.
3. Press  **NEXT** until **Trans Area** is displayed.
4. Press the  **Trans Area** knob.
5. Press  **NEXT**.

6. Use the  **BGDDbl** knob to set the behavior of the Background button when it is double-pressed.
  - **Ignore** — Select this option to not include the on-air keyers with the next transition when the **BKGD** button is double-pressed.
  - **TrsClr** — Select this option to include all on-air keyers with the next transition when the **BKGD** button is double-pressed.

# Basic Operation

This chapter describes the general operation of your switcher. Basic information is provided to help you become familiar with switcher operation.

## Transition Overview

Transitions allow you to replace the on-air video source with another source. During a transition, the source you selected on the Preset bus becomes active on the Program bus and the source that was active on the Program bus is now active on the Preset bus.

You can perform the following types of transitions:

- **Cuts** — The video image instantly switches between selected sources.
- **Dissolves** — The video image gradually fades from the on-air source to the selected source.
- **Wipes** — The selected source wipes over the on-air source using a user-specified pattern and direction.
- **DVE** — The video image is taken off-air using a selected digital video effect.
- **Media** — The video image cuts to another video image behind a playing animation or still.

### Note:

- If any of the inputs going on-air have an assigned GPI output, the GPI output is triggered and the switcher then waits the configured pre delay interval before performing the transition. If you perform a transition with the fader handle, the GPI output is triggered but the pre delay interval is ignored.
- If any of the inputs going on-air are assigned to a video server, the switcher waits for the configured pre delay interval before performing the transition. If you perform a transition with the fader handle, the pre delay interval is ignored.

### For More Information on...











- assigning a GPI output to an input source, refer to the section “Triggering GPI Outputs” on page 4-15.

## Performing a Transition

A transition can be performed on almost any combination of the background and keyers, depending on the type of transition you are performing, and what you are transitioning. These factors include the number of media resources you

have, and if you are trying to perform a background and keyer transition at the same time.

### To perform a transition:

1. Select the elements to include in the next transition by pressing any one of the following:
  -  **BKGD**
  -  **KEY 1**
  -  **KEY 2**
  -  **KEY 3** (CrossOver 12 only)
2. Select the sources that you want to take on or off-air.
  - For a background transition (**BKGD**), select the source on the Preset bus, that you want to take on-air. The selected source appears on your preview monitor.
  - For a key transition, select the keys and sources on the Key/Aux bus that you want to take on-air.
3. Choose the type of transition you want to perform:
  - Press  **DISS** to select a dissolve transition.
  - Press  **WIPE** to select a wipe transition.
  - Press  **DVE** to select a DVE transition.
  - Press  **DISS** and  **WIPE** to select a media transition.
4. Perform the transition by choosing one of the following:
  - Press  **CUT** to immediately cut the selected source on-air (the selected transition type is ignored).
  - Press  **AUTO TRANS** to have the switcher perform a smooth transition.
  - Move the Fader from one limit to the other to perform a manual transition.

### Note:

- You can select multiple elements for the next transition by pressing and holding the button for

the first element, then pressing one or more of the other next transition buttons.

- While still holding the first element button, press an element button again to remove it from the next transition.
- The Media-Store mode must be set to Swish, or Swish+ to perform a media transition.

#### For More Information on...

- wipe transitions, refer to the section “Wipe Transitions” on page 3-2.
- DVE transitions, refer to the section “DVE Transitions” on page 3-2.
- Media transitions, refer to the section “Media Transitions” on page 3-3.
- including keys in transitions, refer to the section “Key Transitions” on page 3-4.
- the Next Transition area state after a transition, refer to the section “Transition Area Behavior” on page 2-13.
- setting the Media-Store mode, refer to the section “Media-Store Modes” on page 6-1.

## Cutting on the Program Bus

Cuts are the simplest transition, performing an instantaneous change between sources. You can perform a cut transition by pressing **CUT**, or you can perform the transition directly on the Program bus.

This also applies to keys. If a key is on-air, you can select alternate sources on the Key/Aux bus and have them instantly cut on-air.

#### To cut on the Program bus:

- Select the source you want to take on-air by pressing a source button on the Program bus.





#### Note:

- You can not preview the next source on your preview monitor when cutting on the Program Bus.

## Configuring the Auto Trans Rate

You can control the amount of time a dissolve or wipe transition takes to complete when you press the **AUTO TRANS** button. Transitions performed with the Fader are not affected.

#### To change the rate for automatic transitions:

1. Prepare a transition using  **DISS**,  **WIPE**, or  **DVE** as the transition type, but do not perform the transition.
2. Use the  **Time** knob to change the transition duration.
3. Press  **AUTO TRANS** to perform the transition.

#### Note:

- You can set different transition rates for the dedicated **KEY TRANS** buttons.
- For a Media transition, the length of the transition is set by the length of the loaded animation, and not the set transition rate.



#### For More Information on...

- dedicated key transitions, refer to the section “Dedicated Key Transitions” on page 3-5.

## Wipe Transitions

You can select from a number of pre-defined patterns and control the amount of time a wipe transition takes to complete.

#### To perform a wipe transition:

1. Prepare a transition using  **WIPE** as the type of transition, but do not perform the transition.
2. Select the pattern you wish to use for the wipe.
3. Use the  **Time** knob to change the transition duration.
4. Press  **AUTO TRANS** to perform the transition.

#### For More Information on...





- preparing transitions, refer to the section “Transition Overview” on page 3-1.
- modifying Wipe transitions, refer to the section “Modifying Wipes” on page 4-1.

## DVE Transitions

You can select from a number of pre-defined patterns and control the amount of time a DVE transition takes to complete.





**To perform a DVE transition:**

1. Prepare a transition using  **DVE** as the type of transition, but do not perform the transition.
2. Use the  **Time** knob to change the duration of the transition.
3. Press  **NEXT**.
4. Use the  **Effect** knob to select the DVE effect you want to use for the transition, or press a Wipe Pattern button.

**Table 3.1 DVE Effect Selection**

Pattern Button	Single Press Pattern Button DVE Effect	Double Press Pattern Button DVE Effect
0	Push Left	Push Right
1	Push Up	Push Down
2	Squeeze Horizontal	Push Up-Right
3	Squeeze Vertical	Push Down-Left
4	Push Up-Left	Push Down-Right
5	Squeeze Up-Right	Squeeze Down-Left
6	Squeeze Up-Left	Squeeze Down-Right
7	Squeeze to Center	Fly Through
8	Circle Left	Circle Right
9	Stretch	Tumble

5. Use the  **Time** knob to change the transition duration.
6. Press  **AUTO TRANS** to perform the transition.

**Note:**

- You must include the background when performing a DVE transition on a Chroma Key, Self Key, or Auto-Select Key. If you do not include the background, a dissolve transition is performed.
- Performing a DVE transition on a DVE Key without including the background scales the transition effect to the size of the DVE Key. This transition does not consume an additional DVE resource.
- Performing a DVE transition on a DVE Key with the background included does not scale the transition effect. This transition consumes the second DVE resource.





**For More Information on...**

- preparing transitions, refer to the section “Transition Overview” on page 3-1.
- modifying DVE transitions, refer to the section “Modifying DVE Transitions” on page 4-2.

**Media Transitions**

A Media Transition allows you to use an animation to cover a transition. When the transition starts, the switcher plays the selected animation over top of the background and keys that are being transitioned. When the cut point ( ) is reached, the switcher performs a cut transition. It is important to use a fullscreen image in the animation at the cut point so that the cut is not visible on-air.

**To perform a media transition:**

1. Prepare a transition using Media ( **DISS** and  **WIPE**) as the type of transition, but do not perform the transition.
2. Press  **NEXT**.
3. Press the  **Browse** knob.
4. Select the animation you want to use for the transition. Ensure that you have already set the cut point for this still.
5. Press  **AUTO TRANS** to perform the transition.

**Note:**

- Although you can select a still image for a media transition, it is not recommended.
- Only Auto Transition should be used for Media transitions. Using the fader to perform the transition manually could result in jumps in the animation.
- The duration of the transition (**Time**) is set by the length of the animation.



**For More Information on...**

- on setting a cut point for a media transition, refer to the section “Media Transition Attributes” on page 6-5.
- on setting up an animation for a media transition, refer to the section “Media Transition Attributes” on page 6-5.

**Pausing a Transition**

You can pause a transition while it is in progress.

### To pause and resume a transition in progress:

1. Prepare a dissolve, wipe, or DVE transition.
2. Press  **AUTO TRANS** to start the transition.
3. Press  **AUTO TRANS** again to pause the transition.
4. Press  **AUTO TRANS** to resume the transition.

#### Note:

- The transition will continue or reverse based on the setting of the **Resume** personality option.

#### For More Information on...

- preparing transitions, refer to the section “Transition Overview” on page 3-1.
- setting the behavior of a resumed transition, refer to the section “Transition Area Behavior” on page 2-13.
- on performing a DVE transition, refer to the section “Modifying DVE Transitions” on page 4-2.

## Keying Overview

Keying allows you to insert portions of one scene into another. Keys appear as overlays over the background image.

The switcher supports the following key types:

- **Auto-Select Key** — Key alpha (transparency) is provided on one input and key fill video is provided on a second input (character generators and graphics systems typically provide fill and alpha on separate channels).
- **Self Key** — Key transparency is derived from the luminance of the key fill video (this key type is created when you do not specify an input for the key alpha channel).
- **Chroma Key** — A user defined color hue is selected for transparency (such as blue or green-screen applications).
- **DVE Key** — The video image can be scaled, cropped and freely positioned on the screen. Borders and other effects may be used to enhance the key appearance.

The CrossOver 6 supports 2 keys. The CrossOver 12 supports 3 keys.

## Video Layering

Video is layered as shown in Figure 3.1.

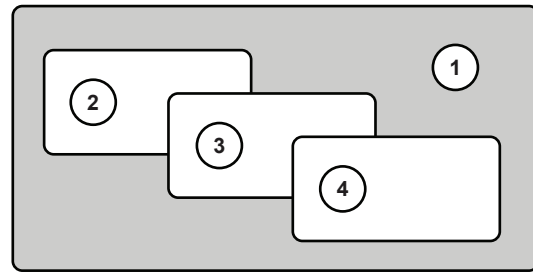

Figure 3.1 Video Layering

1. Program
2. Key 1
3. Key 2
4. Key 3 (CrossOver 12 only)





## Key Transitions

Key transitions are similar to background transitions. You can perform key and background transitions simultaneously.

### Selecting Keys

Selecting a key allows you to configure the key type and select a source for that key.

#### To select a key:

- Select a key by pressing one of the key select buttons. You can choose from the following:
  - ›  **AUTO SELECT**,  **CHR KEY**, or  **DVE** — Selects Key 1 and sets the key type.
  - ›  **KEY 2 SEL** — Selects Key 2.
  - ›  **KEY 3 SEL** — Selects Key 3 (CrossOver 12 only).

#### Note:











- If you select Key 1, you are selecting a key and key type simultaneously.

## Performing Key Transitions

Key transitions are performed similarly to background transitions. All transition types are available for key transitions.

#### To perform a key transition:

1. Ensure the key you are using in the transition is not on-air.
2. Select the key you wish to use.
3. Select the key type by pressing one of the following:

-  **CHR KEY** to create a Chroma Key.
  -  **AUTO SELECT** to create an Auto-Select Key.
  -  **DVE** to create a DVE Key.
4. Press the corresponding key button in the Next Transition area to include the key in the transition. You can choose from the following:
    -  **KEY 1** to include Key 1.
    -  **KEY 2** to include Key 2.
    -  **KEY 3** to include Key 3 (CrossOver 12 only).
  5. Select a source on the Key/Aux bus that you want to take on-air. The selected source appears on your preview monitor over the background image.
  6. Choose the type of transition you wish to perform:
    - Press  **DISS** to select a dissolve transition.
    - Press  **WIPE** to select a wipe transition.
    - Press  **DVE** to select a DVE transition.
  7. Perform the transition by using one of the following methods:
    - Press  **CUT** to immediately cut the selected source on-air (the selected transition type is ignored).
    - Press  **AUTO TRANS** to have the switcher perform a smooth transition.
    - Move the Fader from one limit to the other to perform a manual transition.

**Note:**

- To include multiple keys in the transition, push the desired combination of **KEY 1**, **KEY 2**, and **KEY 3** buttons simultaneously.
- When a key is on-air, the tally above the on-air key glows red.

**For More Information on...**

- selecting keys, refer to the section “Selecting Keys” on page 3-4.

## Dedicated Key Transitions

If an immediate transition is required, or an unexpected transition needs to be performed, the dedicated key transition buttons can be used. Only dissolve transitions can be performed with the dedicated key transition buttons.

**To perform a dedicated key transition:**

1. Ensure that a key, key-type, and source are selected.
2. Take the desired key on or off-air by performing one of the following:
  - Press **KEY 1 TRANS** to transition Key 1.
  - Press **KEY 2 TRANS** to transition Key 2.
  - Press **KEY 3 TRANS** to transition Key 3 (CrossOver 12 only).

**Note:**

- When a key is on-air, the appropriate dedicated key transition button glows red.



**For More Information on...**

- selecting keys, refer to the section “Selecting Keys” on page 3-4.

## Setting the Transition Rate for Dedicated Key Transitions

You can set the transition rate for the dedicated key transition buttons independently of the other switcher transition rates.

**To change the transition rate for dedicated key transitions:**

1. Press  **DISS**.
2. Press  **NEXT**.
3. Use the  **Key 1-3** (1-2 on CrossOver 6) knobs to change the transition rate for the specified key.

**Note:**

- If the transition rate is set to **CUT** and a transition is in progress, pressing a dedicated key transition button immediately cuts the associated key to the previous state (either on or off-air). The rest of the transition proceeds.

**For More Information on...**

- the Next Transition area behavior, refer to the section “Transition Area Behavior” on page 2-13.

## UltraChrome Chroma Key

An UltraChrome™ Chroma Key is a key in which the hole is cut based on a color value, or hue, rather than a luminance value or alpha signal. The color is removed and replaced with background video from another source. The default color is blue.

### UltraChrome Operating Modes



The UltraChrome Chroma Key operates in one of two modes, Basic or Advanced, depending on the complexity of the Chroma Key you are setting up.

- **Basic Mode** — In basic mode, UltraChrome provides a simple background/foreground chroma key with adjustment for background spill and edge softness.
- **Advanced Mode** — In advanced mode, UltraChrome provides advanced background shadow and translucency control, as well as control over background/foreground transition areas.

Although it is possible to switch back and forth between advanced and basic mode, the additional image correction of the advanced mode is only applied in the advanced mode. For example, if you use the basic mode to set up the Chroma Key and then switch to the advanced mode, the entire image may change as the image correctors provided by the advanced mode are applied at their default settings.

Chroma Key adjustments are persistent and are not affected by a soft reset or switcher reboot. However, initializing the Chroma Key or performing a factory reset returns all adjustments to default values.

### UltraChrome Initialization

1. Select the keyer you wish to use. By default, UltraChrome is locked to Key 1 from the Resource Sharing Menu.
2. Select the desired source on the Key/Aux bus.
3. Press  **CHR KEY** to select the key type. If the chroma key is being used by another keyer, you will be prompted to Steal the resources.
4. Use the  **Mode** knob to select the operating mode you want to use.
  - **Basic** — Select this option to operate UltraChrome in basic mode.
  - **Adv** — Select this option to operate UltraChrome in advanced mode.
5. Use the  **Color** knob to select the color you want to key out. This is the background color of your Chroma Key that will be replaced.

6. Press the  **Init** knob to initialize the chroma key. Every time the **Init** knob is pressed, the switcher resets all the Chroma Key parameters to their default settings.
7. Make adjustments to the chroma key as required. How you adjust the chroma key depends on the mode you are in.
  - **Basic** — Refer to the section “Basic UltraChrome Mode Settings” on page 3-6 for setup information.
  - **Adv** — Refer to the section “Advanced UltraChrome Mode Settings” on page 3-7 for setup information.

#### For More Information on...

- selecting Keys, refer to the section “Selecting Keys” on page 3-4.
- Chroma Key sharing, refer to the section “Resource Sharing” on page 2-11.
- taking a Chroma Key on-air, refer to the section “Key Transitions” on page 3-4.

### Basic UltraChrome Mode Settings

The following chroma key parameters can be adjusted in Basic Mode:

- **Background Area** — Allows you to modify the range of colors that are considered background and are masked out of the Chroma Key.
- **Edge** — Allows you to adjust the amount of edge softening applied to the foreground. This helps blend the foreground into the new background.
- **Foreground Area** — Allows you to modify the range of colors that are considered foreground and are not masked.
- **Luminance** — Allows you to adjust the overall brightness of the shadow, translucent, and foreground-background transition area to improve the Chroma Key appearance.
- **Shadow** — Allows you to adjust the amount of shadow extraction from the background. This is the actual shadow that the foreground subject is casting onto the screen.
- **Spill** — Allows you to remove background color casts that may spill into the foreground image (green color cast on the foreground from a green-screen for example).
- **Foreground - Background Transition Gain** — Allows you to adjust the transparency of the foreground - background transition area. This

helps blend the foreground into the new background.



- **Translucency** — Allows you to adjust the size and transparency of translucent, or semi-transparent, areas.

#### To adjust the chroma key in Basic Mode:



1. Select the key you wish to modify (ensure it is set as a Chroma key).

2. Press  **NEXT**.



3. Adjust the Background as follows:

- Use the  **Type** knob to select **Bkgd**.
- Use the  **Cntrl** knob to select **Gain**.
- Use the  **Value** knob to adjust the background gain as follows:
  - › Increasing the Gain value causes the background to appear more opaque. This results in less of the background color being removed.
  - › Decreasing the Gain value causes the background to appear more transparent. This results in more of the background color being removed.

4. Adjust the edges of the foreground as follows:

- Use the  **Type** knob to select **Edge**.
- Use the  **Cntrl** knob to select **Soft**.
- Use the  **Value** knob to add or remove edge softening of the foreground image and alpha channel as follows:
  - › Increasing the Softness value increases the amount of softness applied to the foreground edges and alpha channel.
  - › Decreasing the Softness value decreases the amount of softness applied to the foreground edges and alpha channel.

5. Adjust the Foreground colors, or hues, as follows:

- Use the  **Type** knob to select **Foregd**.
- Use the  **Cntrl** knob to select **Clip**.
- Use the  **Value** knob to adjust the foreground clipping as follows:
  - › Increasing the Clip value removes lower-saturated colors from the foreground image.

- › Decreasing the Clip value includes lower-saturated colors in the foreground image.

- Use the  **Cntrl** knob to select **Hue**.

- Use the  **Value** knob to select the central, or base, color for the foreground as follows:

- › Increasing the Hue value moves counter-clockwise around the color wheel to select a base color.
- › Decreasing the Hue value moves clockwise around the color wheel to select a base color.

- Use the  **Cntrl** knob to select **Reject**.

- Use the  **Value** knob to include or reject hues adjacent to the base color as follows:

- › Increasing the Reject value decreases the amount of adjacent hues that are included in the foreground.
- › Decreasing the Reject value increases the amount of adjacent hues that are included in the foreground.

6. Adjust the amount of background color that is spilling over into the foreground as follows (green color cast on the foreground from a green screen for example):

- Use the  **Type** knob to select **Spill**.

- Use the  **Cntrl** knob to select **Range**.

- Use the  **Value** knob to remove any color cast onto the foreground as follows:

- › Increasing the Range value causes more of the foreground colors to be corrected for background color spill.
- › Decreasing the Range value causes fewer of the foreground colors to be corrected for background color spill.

#### Advanced UltraChrome Mode Settings

The following chroma key parameters can be adjusted in Advanced Mode:

An UltraChrome chroma key, in advanced mode, breaks the image into five elements which determine, or partially determine, which part of the image is keyed out, or removed.

- **Background** — Background elements are those pixels in the source video that are the same color as the one you chose to key out. Note that the

Shadow and translucent areas (see below) are completely contained within the Background area.

- **Shadow** — Shadow elements are those pixels in the source video with colors that are within the Background range, but with lower luminance values, depending on the shadow range. You modify the Shadow range to cover darker areas of the background (e.g. where the foreground is casting a shadow on the background screen).
- **Translucency** — Translucent elements are those pixels in the source video that are in the Background range, but with higher luminance values than the Shadow range. You can control the upper-end of the Translucency range by setting a wider hue-range to constrain the area. You can also control the transparency of the Translucent area.
- **Transition** — Transition elements are those pixels in the source video with colors that are not within any of the previous three ranges and are also not considered part of the Foreground area. These are typically the pixels near the edge of the foreground, where it blends into the background.
- **Foreground** — Foreground elements are those pixels that are not within the Background, Shadow, Translucency, or Transition ranges. This is the area with colors that will not be keyed out and will remain solid.







The remaining three adjustments that can be made to an Advanced UltraChrome chroma key allow you to adjust spill suppression, edge softness and luminance.

- **Spill Suppress** — Spill Suppression elements are those pixels in the Foreground that have a noticeable tint of the Background color. This typically occurs around the edge of the foreground subject as glow from the background blue-screen or green-screen “spills” onto them.
- **Edge Softness** — Edge Softness lets you apply varying degrees of softening to the Foreground edges to help it blend in with the underlying background image that it is being keyed over.
- **Luminance** — Luminance allows you to control the overall brightness of Shadow, Translucency, and Transition areas as well as partial reflections to more closely match the Foreground brightness.



#### To adjust the chroma key in Advanced Mode:



















1. Select the key you wish to modify (ensure it is set as a Chroma key).
2. Press  NEXT.

### 3. Adjust the Background as follows:

- Use the  **Type** knob to select **Bkgd**. Background elements are those pixels in the source video that are the same color as the one you chose to key out. Note that the Shadow and translucent areas (see below) are completely contained within the Background area.
- Use the  **Cntrl** knob to select **NegHue**.
- Use the  **Value** knob to adjust the range of hues that are included in the Background, expanding counter-clockwise around the color wheel.
- Use the  **Cntrl** knob to select **PosHue**.
- Use the  **Value** knob to adjust the range of hues that are included in the Background, expanding clockwise around the color wheel.
- Use the  **Cntrl** knob to select **Sat**.
- Use the  **Value** knob to adjust the saturation range of the background color as follows:
  - › Increasing the Saturation Range value includes a wider range of saturation values to be included in the background.
  - › Decreasing the Saturation Range value includes a narrower range of saturation values to be included in the background.

### 4. Adjust the edges of the foreground as follows:

- Use the  **Type** knob to select **Edge**. Background elements are those pixels in the source video that are the same color as the one you chose to key out. Note that the Shadow and translucent areas (see below) are completely contained within the Background area.
- Use the  **Cntrl** knob to select **Sens**.
- Use the  **Value** knob to set the edge sensitivity as follows:
  - › **Low** — Select this option to reduce the level of detail in the edges of the chroma key. This option will reduce the overall noise in the key image that can be the result of certain lighting conditions or high detail camera settings. This is the default setting.

- › **High** — Select this option to include the maximum detail in the edges of the chroma key.
  - Use the  **Cntrl** knob to select **Soft**.
  - Use the  **Value** knob to add or remove edge softening of the foreground image and alpha channel as follows:
    - › Increasing the Softness value increases the amount of softness applied to the foreground edges and alpha channel.
    - › Decreasing the Softness value decreases the amount of softness applied to the foreground edges and alpha channel.
- 5. Adjust the Foreground area as follows:**
- Use the  **Type** knob to select **Foreground**. The Foreground settings allow you to adjust the range of colors which are considered Foreground colors, and thus keyed fully on.
  - Use the  **Cntrl** knob to select **Clip**.
  - Use the  **Value** knob to adjust the foreground clipping as follows:
    - › Increasing the Clip value removes lower-saturated colors from the Foreground image.
    - › Decreasing the Clip value includes lower-saturated colors in the Foreground image.
  - Use the  **Cntrl** knob to select **Hue**.
  - Use the  **Value** knob to select the central, or base, color for the foreground as follows:
    - › Increasing the Hue value moves counter-clockwise around the color wheel to select a base color.
    - › Decreasing the Hue value moves clockwise around the color wheel to select a base color.
  - Use the  **Cntrl** knob to select **Reject**.
  - Use the  **Value** knob to include or reject hues adjacent to the base color as follows:
    - › Increasing the Reject value decreases the amount of adjacent hues that are included in the foreground.
    - › Decreasing the Reject value increases the amount of adjacent hues that are included in the foreground.
- 6. Adjust the luminance, or brightness, as follows:**
- Use the  **Type** knob to select **Lum**. The luminance settings allow you to adjust the overall brightness of the Shadow, Translucent, and Transition areas to change the appearance of reflections from semi-transparent objects and to match Shadow and Transition area brightness with the Foreground brightness.
  - Use the  **Cntrl** knob to select **BkLuma**.
  - Use the  **Value** knob to change the overall brightness of Shadow, Translucent, and Transition areas as follows:
    - › Increasing the Background Luminance value increases the brightness of Background, Translucent, and Transition areas.
    - › Decreasing the Background Luminance value decreases the brightness of Background, Translucent, and Transition areas.
  - Use the  **Cntrl** knob to select **Refl**.
  - Use the  **Value** knob to change the brightness of semi-transparent reflections (like reflections from glasses) as follows:
    - › Increasing the Reflections value increases the brightness of semi-transparent reflections.
    - › Decreasing the Reflections value decreases the brightness of semi-transparent reflections.
- 7. Adjust the Shadow area as follows:**
- Use the  **Type** knob to select **Shadow**. The Shadow adjustment allows you to extract a shadow from the background. This is the actual shadow that the foreground subject is casting onto the screen.
  - Use the  **Cntrl** knob to select **Gain**.
  - Use the  **Value** knob to adjust the Shadow appearance as follows:
    - › Increasing the Gain value creates darker shadows.
    - › Decreasing the Gain value creates lighter shadows.
  - Use the  **Cntrl** knob to select **Range**.
  - Use the  **Value** knob to adjust the range of the Shadow colors as follows:
    - › Increasing the Range value widens the Shadow area by including lower-luminance background colors. The increased range comes as a result of colors moving from the Translucent area to the Shadow area.

- › Decreasing the Range value narrows the Shadow area by excluding high-luminance colors. These excluded colors move back into the Translucent area.
8. Adjust the amount of background color that is spilling over into the foreground (green color cast on the foreground from a green-screen for example) as follows:
- Use the **Type** knob to select **Spill**.
  - Use the **Cntrl** knob to select **Clip**.
  - Use the **Value** knob to adjust spill suppress clipping as follows:
    - › Increasing the clip value removes higher-saturated colors from spill suppress correction.
    - › Decreasing the clip value includes higher-saturated colors in spill suppress correction. If your foreground image contains bright-colored areas that are suffering from background spill, decrease the clip value to have it corrected.
  - Use the **Cntrl** knob to select **Hue**.
  - Use the **Value** knob to select the central, or base, color for spill suppress correction. If the color spill does not appear to be the same color as the background, use this control to adjust which hue is considered to be “spilled” into the foreground:
    - › Increasing the hue value moves counter-clockwise around the color wheel while selecting a base color.
    - › Decreasing the hue value moves clockwise around the color wheel while selecting a base color.
  - Use the **Cntrl** knob to select **Reject**.
  - Use the **Value** knob to include or reject adjacent hues to the base.
    - › Increasing the reject value increases the amount of adjacent hues that are included in spill correction.
    - › Decreasing the reject value decreases the amount of adjacent hues that are included in spill correction.
9. Adjust the Transition area as follows:
- Use the **Type** knob to select **Trans**. The Transition area is the range of pixels that are left over (i.e. not in the Shadow or Translucency area). The Transition settings

allows you to adjust the appearance of the Transition area.

- Use the **Cntrl** knob to select **Gain**.
  - Use the **Value** knob to adjust the appearance of the Transition colors as follows:
    - › Increasing the Gain value makes the Transition area pixels more opaque.
    - › Decreasing the Gain value makes the Transition area pixels more transparent.
10. Adjust the Translucency area as follows:
- Use the **Type** knob to select **Trnslc**. The Translucency settings allow you to adjust the appearance of clear items such as eye-glass lenses.
  - Use the **Cntrl** knob to select **Gain**.
  - Use the **Value** knob to adjust the appearance of the Translucent colors as follows:
    - › Increasing the Gain value causes the translucent colors to appear more opaque.
    - › Decreasing the Gain value causes the translucent colors to appear more transparent.
  - Use the **Cntrl** knob to select **Range**.
  - Use the **Value** knob to adjust the range of the Translucent colors as follows:
    - › Increasing the Range value widens the Translucent area by including more hues from the Background range (the lower-end of the range is defined by the Shadow range you just set).
    - › Decreasing the Range value narrows the Translucent area by excluding hues.







## DVE Key

The DVE Key allows you to apply digital video effects to an image. These effects include the following:

- Scale
- Crop
- Aspect Ratio
- Position
- Border



### To create a DVE Key:

1. Select the key you wish to use.
2. If you are not using Key 1, press  **DVE** to set the selected Key to a DVE Key.
3. If all DVE Key resources are assigned to other keys, or the transition area and the DVE share mode is set to **FLOAT** or **ASK**, you are prompted to steal the DVE resource to use on the new key. You can choose from the following:
  - Press the  **Confirm** knob to steal the DVE resource for the new key. The old DVE Key is taken off-air and converted to an Auto-Select Key.
  - Press the  **Cancel** knob to cancel the new DVE Key and leave the resource with the key it is currently assigned to.
4. Select the desired source on the Key/Aux bus.
5. Use the  **XPos**,  **YPos**, and  **Size** knobs to control the position and size of the source image.

### For More Information on...



- selecting Keys, refer to the section “Selecting Keys” on page 3-4.
- DVE Resource sharing, refer to the section “Resource Sharing” on page 2-11.
- modifying DVE Key appearance, refer to the section “Modifying DVE Keys” on page 4-4.
- taking a key on-air, refer to the section “Key Transitions” on page 3-4.

### Freezing a DVE Key

You can freeze the video and appearance of a DVE Key. When a DVE Key is frozen, the DVE attribute menus are disabled and you can not move the DVE Key or adjust DVE attributes.

Selecting a new input source for a frozen DVE Key, the DVE freeze is turned off.

### To freeze a DVE Key:

1. Prepare a DVE Key and configure it as desired.
2. Select the DVE Key you wish to freeze.
3. Press  **NEXT** until **Freeze** is displayed.
4. Press the  **Freeze** knob to freeze or un-freeze the DVE Key.

## Mattes

A Matte is a solid color signal that is generated by the switcher and can be adjusted for hue, saturation, and luminance. It can also be adjusted for position, size, aspect, border, and softness.

### For More Information on...

- setting hue, saturation, and luminance, refer to the section “Selecting Colors” on page 1-6.

### Using a Matte



Mattes can be a solid color or a wash. A wash fills the matte with one of the 10 wipe patterns.

### Selecting a Matte Color

You can use two methods to select a matte color:

- Specify hue, saturation, and luminosity
- Load a preset color

### To select a matte color by specifying hue, saturation, and luminosity:

1. Press and hold  **SHIFT**.
2. Press  **BLACK/MATTE** to display the **Matte** menu.
3. Use the  corresponding knob to adjust the Hue (**Hue1**), Saturation (**Sat1**), and Luminance (**Lum1**) to the desired effect.





### Note:

- Mattes may also be selected on the Aux bus. Use the  **MATTE** button on the desired Aux bus to select a matte color for that bus.

### For More Information on...

- accessing an Aux bus, refer to the section “Aux Buses” on page 4-5.

### To select a matte color by loading a preset:

1. Press and hold  **SHIFT**.
2. Press  **BLACK/MATTE** to display the **Matte** menu.
3. Press  **NEXT**.
4. Use the  **Load** knob to select the preset color you wish to use.
5. Press the  **Load** knob to load the preset color.





**Note:**

- Mattes may also be selected on the Aux bus. Use the  **MATTE** button on the desired Aux bus to select a matte color for that bus.

**For More Information on...**

- accessing an Aux bus, refer to the section “Aux Buses” on page 4-5.

**To change the pattern:**

1. Press and hold  **SHIFT**.
2. Press  **BLACK/MATTE** to display the **Matte** menu.
3. Press  **NEXT** until **WASH** is displayed.
4. If the  **WASH** knob is **Off**, toggle it **On** by pressing the  **WASH** knob.
5. Use the Pattern buttons to select the desired pattern.

**Note:**

- If the wash is turned off, the pattern does not display.
- Pattern washes are not available on Aux buses.

**Using other Wash Adjustments**

Washes can be adjusted by using these modifiers:

- **Size** — Size
- **X-Pos, Y-Pos** — Position
- **Aspect** — Aspect Ratio
- **Border** — Border Appearance
- **Softness** — Edge Softness
- **Hue 2, Sat 2, and Lum 2** — Secondary Color

The **Aspect** function allows you to alter the shape of the selected wash pattern. For example, if you want the wash to be oval shaped, select the circular pattern and adjust the aspect ratio until the desired oval is created.



Borders are effects created around the selected pattern for the wash. The **Border** function allows you to adjust the appearance of the border.

The **Softness** function controls the wash edge appearance. It is a pattern edge effect produced by mixing key source and key fill signals allowing variable control of edge softening.

The **Hue 2, Sat 2, and Lum 2** functions control the secondary color. If you are creating a wash and want to add a second color, adjusting these options will

generate and modify another color set within the pattern.

**To apply other adjustments:**

1. Press and hold  **SHIFT**.
2. Press  **BLACK/MATTE** to display the **Matte** menu.
3. Press  **NEXT** until the desired modifier is displayed.
4. Adjust the desired modifier by rotating the corresponding knob.





**Note:**

- If the wash is turned off, the pattern does not display.
- The wash pattern and the key pattern mask are shared. Any adjustments affect both patterns.

**Fade to Black**

Fade to Black is achieved by selecting the black source and performing a transition.

**To fade to black:**

1. Press  **BKGD** and all on-air key buttons simultaneously to include them in the transition.
2. Select a transition type.
3. Press  **BLACK/MATTE** on the Preset bus.
4. Fade to black by sliding the Fader, pressing  **CUT**, or pressing  **AUTO TRANS**.

# Advanced Operation

This chapter describes advanced operating concepts for your switcher. Topics and information on modifying basic concepts to fit your requirements are also discussed.

## Transition Limit

You can stop a transition at a preset position between the two Fader limits. With the transition limit enabled, an automatic transition will stop when it reaches the defined limit.

### To define the transition limit point:

1. Press **DISS**, **WIPE**, or **DVE**.
2. Press **NEXT** until **Limit** is displayed.
3. Move the Fader to the desired position you wish to set as a transition limit.
4. Press the **Limit** knob.

The Progress Bar next to the Fader flashes to indicate the defined transition limit.

### Note:

- Ensure that you are not on-air when setting the transition limit as you will be moving the Fader handle to define the preset position.

### To perform a transition with a transition limit set:

1. Initiate a transition by pressing **AUTO TRANS**.  
When the transition reaches the defined limit, it will stop.
2. To reverse the transition, press **AUTO TRANS**.
3. To continue the transition, press the **Limit** knob to turn off the transition limit.
4. Press **AUTO TRANS** to complete the transition.

### To Quickly Reset the Transition Limit

- Double-press the **Limit** knob.

## Modifying Wipes

Wipes can be modified to give more distinct qualities and personalize your transitions. The following effects can be adjusted:

- Time, Direction
- Pattern, Horizontal Multiplication, Vertical Multiplication
- X-Position, Y-Position, Aspect Ratio
- Border, Border Color, Border Softness
- Hue, Saturation, Luminosity
- Rotation

### To modify time and direction:

1. Press **WIPE** to display the **Wipe** menu.
2. Press **NEXT** until **Time** is displayed.
3. Use the **Time** knob to change the duration of the wipe.
4. Use the **Dirctn** knob to set the direction of the wipe. You can choose from the following:
  - **Fwd** — Wipe runs in the forward (default) direction.
  - **Rev** — Wipe runs in the reverse direction.
5. Press the **Direction** knob to alternately enable and disable the flip-flop direction feature. You can choose from the following:
  - **Enabled (FF)** — The first time a wipe transition is performed, it runs in the forward direction. Performing a second wipe transition runs in the reverse direction.
  - **Disabled** — Wipes always run in the direction specified in step 4 above.

### To change other wipe modifiers:

1. Press **WIPE** to display the **Wipe** menu.
2. Press **NEXT** to cycle through the available wipe modifiers.

3. Use the  corresponding knob to change the following:
  - **Pattern (Pattn)** — To find and select a desired pattern.
  - **X Pos** or **Y Pos** — To position the wipe pattern.
  - **Aspect** — To adjust the aspect ratio.
  - **Border Size (Border)** — To adjust the size of the border.
  - **Image Softness (Soft)** — To blur or harden the border.
  - **Border color** (only available if you set the Border Size greater than 0.0%)
    - › Use the **Load** knob to select a preset color. Press the **Load** knob to load the color.
    - › Use the **BHue**, **BSat**, and **BLum** knobs until the desired color is achieved.
  - **Rotation (Rot)** — To rotate the pattern.
  - **Horizontal (HMult)** and **Vertical (VMult) Multiplication** — To create multiple instances of the pattern.

**Note:**



- You can select a pattern using the Pattern Buttons. This also displays the **Wipe** menu.
- The **X Pos** and **Y Pos** can be adjusted using the positioner (CrossOver 12 only).
- Aspect adjustments are not available for all patterns.
- Circle, left square, right square, and diagonal patterns with aspect adjustments can not be rotated.



## Modifying DVE Transitions

DVE transitions can be modified to suit the needs and style of your production. The following effects can be adjusted:



- Time
- Direction
- DVE Effect

**To modify time and direction:**

1. Press  **DVE** to display the **DVE** menu.
2. Press  **NEXT** until **Time** is displayed.
3. Use the  **Time** knob to change the duration of the DVE transition.

4. Use the  **Dirctn** knob to set the direction of the DVE transition. You can choose from the following:
  - **Fwd** — Transition runs in the forward (default) direction.
  - **Rev** — Transition runs in the reverse direction.
5. Press the  **Dirctn** knob to alternately enable and disable the flip-flop direction feature. You can choose from the following:
  - **Enabled (FF)** — The first time a DVE transition is performed, it runs in the forward direction. Performing a second DVE transition runs in the reverse direction.
  - **Disabled** — DVE transitions always run in the direction specified in step 4 above.

**To select a DVE effect for a transition:**

1. Press  **DVE** to display the **DVE** menu.
2. Press  **NEXT** until **Effect** is displayed.
3. Use the  **Effect** knob to select which DVE effect to use for the transition.

**Note:**

- You can also select an effect by pressing the Wipe Pattern buttons as shown in Table 4.1:

**Table 4.1 DVE Effect Selection**







Pattern Button	Single Press Pattern Button DVE Effect	Double Press Pattern Button DVE Effect
0	Push Left	Push Right
1	Push Up	Push Down
2	Squeeze Horizontal	Push Up-Right
3	Squeeze Vertical	Push Down-Left
4	Push Up-Left	Push Down-Right
5	Squeeze Up-Right	Squeeze Down-Left
6	Squeeze Up-Left	Squeeze Down-Right
7	Squeeze to Center	Fly Through
8	Circle Left	Circle Right
9	Stretch	Tumble

- Using the  **Effect** knob allows you to select additional DVE effects that are not assigned to pattern buttons.

## Advanced Keying

Keys can be modified to give them more distinct qualities and personalize your images.











### To modify Auto-Select or Self Key transparency:

1. Select an  **Auto-Select** or  **Self Key**.
2. If necessary, press  **KEY 1**,  **KEY 2**, or  **KEY 3** to include the key in the next transition and have it display on the Preview monitor.
3. Rotate the  **Transp** knob until the desired effect is achieved.

### For More Information on...

- selecting keys, refer to the section “Selecting Keys” on page 3-4.











### To apply a mask to an Auto-Select, Self Key, or Chroma Key:

1. Select an  **Auto-Select**,  **Self Key**, or  **Chroma Key**.
2. If necessary, press  **KEY 1**,  **KEY 2**, or  **KEY 3** to include the key in the next transition and have it display on the Preview monitor.
3. Press  **NEXT** until **Mask** is displayed.
4. Use the  **Mask** knob to select the desired state. You can choose from the following:
  - **Off** — This is the default setting.
  - **Box** — This creates a box mask.
  - **Patrn** — This creates a pattern mask.
5. If you are creating a pattern mask, Press a Wipe Pattern button to select the desired pattern.
6. Press  **NEXT** until **Size** is displayed.
7. Use the  **Size** knob to modify the mask size.
8. Press  **NEXT** repeatedly to access other mask modifiers. Use the knobs to modify mask attributes.

### For More Information on...

- selecting keys, refer to the section “Selecting Keys” on page 3-4.

### To modify a mask:

1. Select an  **Auto-Select**,  **Self Key**, or  **Chroma Key**.
2. If necessary, press  **KEY 1**,  **KEY 2**, or  **KEY 3** to include the key in the next transition and have it display on the Preview monitor.
3. Press  **NEXT** until **Mask** is displayed.
4. Use the  **Mask** knob to select the mask source. You can choose from the following:
  - **Off** — This is the default setting.
  - **Box** — This creates a box mask.
  - **Patrn** — This creates a pattern mask.
5. Use the  **M-Frc** knob to force the area inside the mask region to the foreground. You can choose from the following:
  - **Off** — The area inside the mask region is not forced to the foreground. This is the default setting.
  - **On** — The area inside the mask region is forced to the foreground.
6. Use the  **M-Inv** knob to invert the mask. You can choose from the following:
  - **Off** — The mask is not inverted. This is the default setting.
  - **On** — The mask is inverted. Masked portions of the key become visible and visible portions become masked.

### Note:

- The wash pattern and the key pattern mask are shared. Any adjustments affect both patterns.

### For More Information on...

- selecting keys, refer to the section “Selecting Keys” on page 3-4.

### Modifying Other Attributes

There are a number of other attributes you can modify to change the mask appearance. Press **NEXT** and use the knobs to access and change other attributes.

### Modifying Clip and Gain for Unshaped Auto-Select Keys





If an Auto-Select key is unshaped, you can also modify the clip and gain.

The Clip function adjusts the threshold level of the key. Only areas of the source video that are higher

than the setting of the threshold cut a hole in the background video.

Increasing Gain causes the color to become increasingly saturated.

#### To modify the clip or gain:

1. Select the key you wish to modify.
2. If necessary, press  **KEY 1**,  **KEY 2**, or  **KEY 3** to include the key in the next transition and have it display on the Preview monitor.
3. Rotate the  **Clip** and  **Gain** knobs until the desired effect is achieved.



#### For More Information on...

- selecting keys, refer to the section “Selecting Keys” on page 3-4.

#### Converting Between Shaped and Unshaped Auto-Select Keys

You can convert an unshaped Auto-Select key to a shaped Auto-Select key by using the Make Linear function. This disables any modifiers to the selected key.

#### To convert an unshaped Auto-Select key to shaped:

1. Select the unshaped Auto-Select key you wish to modify.
2. Press  **NEXT** until **Make Linear** is displayed.
3. Press the  **Make Linear** knob.

#### For More Information on...



- selecting keys, refer to the section “Selecting Keys” on page 3-4.
- setting the Chroma Key share mode, refer to the section “Resource Sharing” on page 2-11.

### Modifying DVE Keys















You can control aspects of DVE keys using the **DVE Key** menu. The following effects can be modified:





- Screen Position
- Scale
- Aspect Ratio
- Borders
- Cropping

#### To position a DVE Key on the screen:

1. Select the key you wish to modify (ensure it is set as a DVE key).
2. Use the  **X Pos** knob or the positioner to control the horizontal location of the key image.
3. Use the  **Y Pos** knob or the positioner to control the Vertical location of the key image.

#### To change other DVE Key modifiers:

1. Select the key you wish to modify (ensure it is set as a DVE key).
2. Press  **NEXT** to cycle through the available modifiers.
3. Use the  **Size** knob to scale the image. Larger values produce a larger image while smaller values produce a smaller image.
4. Use the  **Aspect** knob to change the aspect ratio of the image. Larger values stretch the image vertically while smaller values stretch the image horizontally.
5. Use the  **Border** knob to adjust the size of the border. A value of 0.0% removes the border.
6. Use the  **Soft** knob to adjust the border softness. If the Border size is set to 0.0%, the edges of the key image are softened. Larger values produce a softer border while smaller values produce harder edged borders edges.
7. Set the border color (only available if you set the Border Size greater than 0.0%) as follows:
  - Use the  **Load** knob to select a preset color. Press the  **Load** knob to load the color.
  - Use the  **BHue**,  **BSat**, and  **BLum** knobs until the desired color is achieved.
8. Press the  **HCrop** knob to change the horizontal cropping behavior. You can choose from the following:
  - **HCrop** — Use the  **HCrop** knob to crop the image from both the left and right sides.
  - **Left/R** — Use the  **Left/R** knob to crop the image from the left side.
  - **L/Rght** — Use the  **L/Rght** knob to crop the image from the right side.

9. Press the  **VCrop** knob to change the vertical cropping behavior. You can choose from the following:
  - **VCrop** — Use the  **VCrop** knob to crop the image from both the top and bottom.
  - **Top/B** — Use the  **Top/B** knob to crop the image from the top.
  - **T/Bttm** — Use the  **T/Bttm** knob to crop the image from the bottom.





## Split Keys

A Split key allows you to assign a different alpha source for a key than the fill/alpha associations that are set up during configuration or to use a separate alpha source for a Self key.

### To create a Split key:

1. Select a source on the Key/Aux bus to act as the video fill (the source can be either an Auto-Select key or a Self key).
2. Press and hold the  **AUTO SELECT** button.
3. Select a source on the Key/Aux bus to act as the key alpha.



### Note:

- Split keys are initially created with the clip set to 50% and gain set to 50%.
- While holding the  **AUTO SELECT** button to select the key alpha, the  **SHIFT** button stays active when pressed. You do not have to hold down  **SHIFT** to access shifted sources. Press  **SHIFT** again to return to normal source selection.

## Modifying Split Keys

You can modify the appearance of a Split key to suit your application.

### To modify the appearance of a Split key:

1. Create a Split key. The **Key** menu is displayed with a new first page.
2. Use the  **Alpha** knob to select the input used for the key alpha.
3. Press the  **Alpha** knob to accept the change.

### Note:

- If you wish to use a matte for the key fill, press the  **Matte** button on the Key/Aux bus to access the **Matte** menu.
- If you are using a Split key with a matte key fill and you wish to turn the key into a Chroma key, the switcher will default to black on that key.

### For More Information on...

- creating a Split key, refer to the section “Split Keys” on page 4-5.

## Aux Buses

The switcher has four timed Aux buses which have access to the following sources:

- Any input source
- Mattes
- Media-Store channels
- Program
- Clean Feed
- Preview
- Chroma Key Alpha

### Note:

- If you turn on the MultiView for Pgm2, Aux 4 is turned off and the MultiView output is fed out of that output BNC instead.
- If you turn on Swish or Swish+ Media-Store Mode, Aux 4 is turned off.

## Accessing Aux Buses

CrossOver 12: The Aux buses can be accessed from control panel buttons.

CrossOver 6: The Aux buses can be accessed through the menu system.

### To access Aux buses on the CrossOver 6:

1. Press **AUX SEL** to display the **Aux** menu.
2. Select an Aux bus by pressing the corresponding knob (**Aux 1** to **Aux 4**).

### To access Aux buses on the CrossOver 12:

1. Select an Aux bus by pressing the corresponding **AUX** button. Aux 4 can be accessed through the **Aux** menu or by pressing the **AUX 1** and **AUX 3** buttons.

## Selecting a Source on an Aux Bus

Once an Aux bus has been selected, you can change the source.

### To select a source on an Aux bus:

1. Select the Aux bus you wish to choose a source on.
2. Press the desired source button on the Key/Aux bus.

#### Note:

- You can also select a matte color for an Aux bus.

#### For More Information on...

- selecting matte colors, refer to the section “Mattes” on page 3-11

### Selecting a Special Source on an Aux Bus

You can select the following special sources by selecting them on the Preset bus:

- Program bus output (**AUX PGM**)
- Preset bus output (**AUX PV**)
- Clean Feed (**AUX CLN**)
- Chroma Key Alpha (fourth source button)

These special sources are found on the first four buttons on the Preset bus.





### To select a special source on an Aux bus:

1. Select the Aux bus you wish to choose a source on.
2. Press and hold  **SHIFT** on the Key/Aux bus.
3. Press any of **AUX PGM**, **AUX PV**, **AUX CLN**, or the fourth source button (to access Chroma Key Alpha) on the Preset bus.

### Fixing an Aux Bus to a Source

You can fix an Aux bus to a specific source. When fixed, the selected source can not be changed by selecting a different source on the control panel Aux bus, performing a memory recall or soft reset, or by an external editor.

### To configure Aux bus fixing:

1. Press  **MENU**.
2. Press the  **SYSTEM** Wipe Pattern button.
3. Press  **NEXT** until **Fix Aux** is displayed.
4. Press the  **Fix Aux** knob to display the **Aux bus Fix** menu.
5. Use the  **Aux** knob to select the Aux bus you wish to configure.

6. Use the  **Output** knob to select which source the Aux bus is fixed to. You can choose from the following:
  - **NotFix** — The Aux bus is not fixed to a specific source.
  - **PGM** — Program bus output
  - **PV** — Preset bus output
  - **CLN** — Clean Feed output
  - **ALPHA** — Chroma Key Alpha
  - **BK** — Color black
  - **BG** — Matte generator.
  - **1-12** (1-6 for CrossOver 6) — Source inputs
  - **M1-4** — Media-Store channels

#### Note:

- Media-Store channels 3 and 4 are only available when the Media-Store mode is set to **Dual**, **Swish**, or **Swish+**.
- If you are using CrossOver CleanSwitch, Aux bus 1 and Aux bus 2 can not be fixed.
- Resetting your switcher to a user-defined state, or factory default state, overrides any fixed Aux bus settings.
- If the Pgm2 MultiViewer is turned on, Aux 4 is turned off.
- If the Media Wipes feature is set to Swish, or Swich+, Aux 4 is turned off.

#### For More Information on...

- setting the Media-Store mode, refer to the section “Media-Store Modes” on page 6-1.
- CrossOver CleanSwitch, refer to the section “CrossOver CleanSwitch” on page 2-8.
- resetting your switcher, refer to the section “Reset Options” on page 4-9.

## Creating an FTP Connection

You can create an FTP (File Transfer Protocol) connection from a computer to your switcher. You can use the FTP connection to copy still images and animations to and from your switcher as well as copy EDL (Edit Decision List) files from your switcher.

The procedure for creating an FTP connection varies between operating systems and client software. Consult with your IT department if you require assistance with creating an FTP connection.

The following procedure describes how to create an FTP connection using Microsoft® Windows® XP Professional, or Windows 7, and the Windows Explorer.



**To create an FTP connection to your switcher from Windows XP Professional, or Windows 7:**

1. On the taskbar, click that **Start** button.
2. Select **All Programs > Accessories > Windows Explorer**.
3. In the Windows Explorer address bar, type ftp://<ip\_addr>
  - where <ip\_addr> is the IP address of your switcher).
4. Enter the following when prompted for a user name and password:

**Table 4.2 FTP Account Information**

User Name	Password	Account Type
xpression	password	Use for accessing Media-Store storage.
liveedl	password	Use for accessing Live EDL storage.
user	password	General storage access

**Note:**

- The **user** and **xpression** accounts also have access to the USB drive if one is plugged into your switcher.

**Live Edit Decision Lists (EDL)**

Edit Decision Lists are files used by non-linear editing (NLE) suites to aid in post-production. Your switcher can capture EDL data in a file that you load into your NLE suite.

**Configuring Live EDL Behavior**

You can configure your switcher to trigger multiple GPI outputs at the start, end, or both of EDL data capture. You can also set a pre-delay for each GPI output. EDL data capture does not begin until the highest pre-delay has passed. This is useful when the switcher needs to wait for external equipment to become ready. The example below shows the effects of various triggering and pre-delay settings.

**Table 4.3 Live EDL GPI Output Triggers**

GPI Output	Triggered On	Pre-Delay (Frames)
1	Start	12
2	Both	16
3	Stop	—

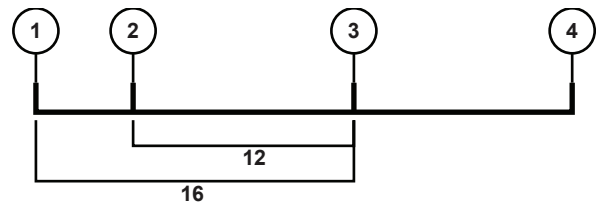

**Figure 4.1 Live EDL Timeline**

1. EDL capture is manually started. GPI output 2 is triggered.
2. 4 frames later, GPI output 1 is triggered.
3. 16 frames after EDL capture is manually triggered, the switcher begins capturing EDL data.
4. EDL capture is manually stopped. GPI output 2 and 3 are triggered.

**To configure Live EDL behavior:**

1. Press **MENU** MENU.
2. Press the **SYSTEM** Wipe Pattern button.
3. Press **NEXT** NEXT until **LivEDL Config** is displayed.
4. Press the **LiveEDL Config** knob to display the EDL Configuration menu.
5. Use the **GPO** knob to select a GPI output. You can choose from any GPI bank and pin that has been configured as a GPI output.
6. Use the **Triggr** knob to select when the GPI output is triggered. You can choose from the following:
  - **Off** — The GPI output is not triggered.
  - **Start** — The GPI output is triggered at the start of EDL data capture.
  - **Stop** — The GPI output is triggered at the end of EDL data capture.
  - **Both** — The GPI output is triggered at both the start and end of EDL data capture.
7. If you selected **Start** or **Both** in step 6, use the **PreDly** knob to specify the number of frames the switcher delays after the GPI output is triggered before EDL capture begins.







**Note:**

- If no GPI banks are configured as outputs, you can not select a GPI output in step 5 above.
- If the selected GPI output is configured as a level trigger, it remains in the latched state until you unlatch it.

**For More Information on...**

- configuring GPI banks, refer to the section “General Purpose Interface (GPI)” on page 4-14.

**To apply an offset to LTC timecode data:**

1. Press  **MENU**.
2. Press the  **SYSTEM** Wipe Pattern button.
3. Press  **NEXT** until **Config LiveEDL** is displayed.
4. Press the  **Config LiveEDL** knob to display the **EDL Configuration** menu.
5. Press  **NEXT** until **LTCOff** is displayed.
6. Use the  **LTCOff** knob to select an offset (in frames) to apply to the LTC timecode.

**Note:**





- LTC offsets are only available if you are using a GearLite TSC-9902 LTC to Serial Converter.

**Capturing EDL Data**

Capturing EDL data is manually started and stopped. You can retrieve EDL files via an FTP connection or by saving them to a USB drive. You can delete EDL files from the switcher to free space for more data capture.

- \* *It is strongly recommended that you use a GearLite TSC-9902 LTC to Serial Converter to provide timecode information when capturing EDL data.*

**To start capturing an EDL file:**

1. Press  **MENU**.
2. Press the  **USER** Wipe Pattern button.
3. Press the  **LiveEDL** knob to display the **LiveEDL** menu.
4. Use the  left knob to select the EDL file you wish to capture to.
5. Press the  **Start** knob.





**Note:**

- A maximum of 999 EDL files may be present on the switcher.

**For More Information on...**

- installation and configuration of the TSC-9902 LTC to Serial Converter, refer to your TSC-9902 documentation.









**To stop capturing an EDL file:**

1. Press  **MENU**.
2. Press the  **USER** Wipe Pattern button.
3. Press the  **LiveEDL** knob to display the **LiveEDL** menu.
4. Press the  **Stop** knob.

**Saving, Deleting, and Accessing EDL Files**

You can save captured EDL files to a USB drive, delete files from the switcher to make room for more data capture, and access EDL files stored internally on the switcher via an FTP connection.

**To save or delete a captured EDL file**

1. Insert a USB drive into the USB port if you are saving EDL files.
2. Press  **MENU**.
3. Press the  **USER** Wipe Pattern button.
4. Press the  **LiveEDL** knob to display the **LiveEDL** menu.
5. Use the  left knob to select the EDL file you wish to save or delete.
6. Save or delete the EDL file by performing one of the following:
  - Press the  **Save** knob to save the EDL file to a USB drive connected to your switcher.
  - Press the  **Delete** knob to delete the EDL file.
7. Press the  **Confirm** knob to perform the save or delete. Press the  **Cancel** knob to cancel the save or delete.

**Note:**

- Wait 5 seconds after inserting a USB drive into the USB port before using it.
- If you select a file that has no captured EDL data, the save and delete options are not available.

## To Access EDL files via an FTP connection

1. Create an FTP connection from a computer to your switcher using the following user account:
  - name: **liveedl**
  - password: **password**
2. Copy EDL files from the switcher to your computer for use in your NLE suite.
3. Close the FTP connection.

### For More Information on...









- creating an FTP connection, refer to the section “Creating an FTP Connection” on page 4-6.

## Using Internal Timecode with EDL Files

If you are not using a Ross Video GearLite TSC-9902 LTC to Serial Converter to provide timecode information, you may use an internally generated base timecode that begins at 0 when EDL capture begins.

You may specify an offset that is applied to the base timecode to meet individual requirements.

### To apply an offset to internally generated base timecode:

1. Ensure that the switcher Editor setting is not set to **LTC**.
2. Press  **MENU**.
3. Press the  **SYSTEM** Wipe Pattern button.
4. Press  **NEXT** until **Config LiveEDL** is displayed.
5. Press the  **Config LiveEDL** knob to display the EDL Configuration menu.
6. Press  **NEXT** until **Hour Minute Second** is displayed.
7. Use the  **Hour** knob to select the required hours offset.
8. Use the  **Minute** knob to select the required minutes offset.
9. Use the  **Second** knob to select the required seconds offset.

### For More Information on...

- configuring the switcher Editor setting, refer to the section “Editor Control” on page 2-13

## Reset Options

You can restore the entire switcher or individual settings to default values. Menu items can also be reset.

You can also capture the state of the switcher as a user-defined default, allowing you to reset to those settings at any time.









### Note:

- Default transition rates vary depending on the frequency of the selected video format.





## Configuring Default Settings

You can customize many of the default switcher parameters and save them as a user-defined default.

### To configure user-defined defaults:

1. Configure the switcher as desired. This will become the new default state.
2. Press  **MENU**.
3. Press the  **RESET** Wipe Pattern button.
4. Press  **NEXT** until **Attrib** is displayed.
5. Use the  **Attrib** knob to select **Media**.
6. Set whether Media-Store channels are included in the reset as follows:
  - Use the  **Media** knob to select the Media-Store channel you wish to configure.
  - Use the  **Value** knob to select whether the Media-Store channel is included in the reset. You can choose from the following:
    - › **NoRst** — The Media-Store channel is not reset. Any loaded image or animation is retained.
    - › **Reset** — Any loaded image or animation is removed and the Media-Store channel is returned to the default state.
7. Use the  **Attrib** knob to select **Aux**.
8. Set whether Aux buses are included in the reset as follows:
  - Use the  **Aux** knob to select the Aux bus you wish to configure.
  - Use the  **Value** knob to select whether the Aux bus is included in the reset. You can choose from the following:
    - › **Reset** — The Aux bus is included in the reset.







- › **NoRst** — The Aux bus is not included in the reset.

9. Press  **NEXT** until **RState Save** is displayed.
10. Press the  **RState Save** knob to save the new default settings.
11. Press the  **Confirm** knob to commit the save. Press the  **Cancel** knob to cancel the save and return to the previous setting.

### Restoring Default Settings to Factory State

You can restore user-defined default settings to a factory state. This is useful if you wish to begin creating a new user-defined default from a known starting configuration.

**To restore user-defined default settings to the factory state:**

1. Press  **MENU**.
2. Press the  **RESET** Wipe Pattern button.
3. Press  **NEXT** until **RState Dfault** is displayed.
4. Press the  **RState Dfault** knob to restore the user-defined defaults to factory settings.
5. Press the  **Confirm** knob to commit the change. Press the  **Cancel** knob to cancel the change and return to the previous setting.



### Resetting the Switcher

Resetting the switcher restores the user-defined default settings.

**To reset the switcher:**

1. Press and hold  **MENU**.
2. Press the  **RESET** Wipe Pattern button.

**To reset the switcher using an alternate method:**

1. Press  **MENU**.
2. Press the  **RESET** Wipe Pattern button.
3. Press the  **RState Load** knob.

All switcher settings are restored to the user-defined default values.

### Shared Parameters

Some parameters are shared between features and if reset in one area, are reset in all areas that share that parameter. The shared parameters are:

- **Time** — This value is shared between dissolves, wipes, and DVE transitions.
- **Limit** — This value is shared between dissolves, wipes, and DVE transitions.
- **Pattern (Patrn)** — This value is shared between wipes and mattes.

### Resetting Individual Settings

You can reset individual settings to user-defined default values rather than resetting the entire switcher.

**To reset wipes:**

1. Press and hold down **WIPE**.
2. Press the  **RESET** Wipe Pattern button.

**To reset dissolves:**

1. Press and hold down **DISS**.
2. Press the  **RESET** Wipe Pattern button.

**To reset Key 1:**

1. Press and hold down **CHR KEY, AUTO SELECT**, or **DVE**.
2. Press the  **RESET** Wipe Pattern button.

**Note:**

- The selected Chroma Key color and any Split Key assignments are not reset.

**To reset Key 2 or 3:**

1. Press and hold down **KEY 2 SEL** or **KEY 3 SEL**.
2. Press the  **RESET** Wipe Pattern button.

When resetting a key, the selected Chroma Key color and any Split Key assignments are not reset.

**Note:**

- The selected Chroma Key color and any Split Key assignments are not reset.

**To reset Aux buses:**

1. Press and hold down **AUX SEL** (CrossOver 6) or **AUX 1** or **AUX 2** or **AUX 3** (CrossOver 12).
2. Press the  **RESET** Wipe Pattern button.

## Resetting Menu Items

The values for particular parameters can be reset individually. This allows you to restore the default setting if you are unsatisfied with the adjusted values.

Some parameters are shared between features and, if reset in one area, will be reset in all areas that share that parameter.







### To reset individual menu items:

1. Select the menu for the value you wish to reset.
2. Double press the knob associated with the value.

## Restoring the Default Bus Map

You can restore your switcher to the default Bus Map if you no longer wish to use a customized Bus Map.

### To restore the default Bus Map:







1. Press  **MENU**.
2. Press the  **RESET** Wipe Pattern button.
3. Press  **NEXT** until **Dfault BusMap** appears.
4. Press the  **Dfault BusMap** knob.
5. Press the  **Confirm** knob to perform the reset.  
Press the  **Cancel** knob to cancel the reset.

## Restoring to Factory Defaults

You can restore your switcher to the factory default settings. You may wish to do this when troubleshooting problems with your switcher.

Restoring to factory defaults resets the entire switcher. Save any configuration information to a memory register if you wish to re-load it after performing the factory default.

### To restore factory defaults:

1. Press  **MENU**.
2. Press the  **RESET** Wipe Pattern button.
3. Press  **NEXT** until **Factry Reset** appears.
4. Press the  **Factry Reset** knob.
5. Press the  **Confirm** knob to perform the reset.  
Press the  **Cancel** knob to cancel the reset.

## Tallies

The switcher has tally relays assigned to inputs as follows (pin 1 is the top right pin when looking at the Tally Port):



Figure 4.2 Tally Port

Table 4.4 Tally Port Pinout

Pin	Input
1	1
2	3
3	5
4	7
5	Common Ground
6	2
7	4
8	6
9	8

When the corresponding input is on-air, the associated tally pin is closed, creating a contact closure.

### Note:

- Tally wiring can be difficult. Consult with your facility engineer before undertaking any tally wiring.

### For More Information on...

- port locations, refer to the section “Frame Rear Connections Overview” on page 1-3.

## Device Control

Your switcher can connect to and control a variety of external broadcast equipment. Refer to the *Ross Video External Device Setup Sheet* for your particular device for complete connection and configuration information.

### Note:











- Device control menus are easily accessed even when the switcher auto-follows to a different menu. Refer to the section “Auto-Follow” on page 1-4 for more information.

## Adding, Modifying, and Removing Devices

External devices must be added to the switcher and then assigned to an input before they can be

controlled. You can also edit device settings and remove a device from the switcher.







#### To add a device:





1. Press  **MENU**.
2. Press the  **SYSTEM** Wipe Pattern button.
3. Press  **NEXT** until **Device Config** is displayed.
4. Press the  **Device Config** knob to display the **Device Configuration** menu.
5. Press the  **Add** knob to display the **Device Add** menu.
6. Use the  **Slot** knob to select a slot to assign the device to.
7. Use the  **Type** knob to select the device type you are adding.
8. Use the  other knobs to set device settings as necessary.
9. Press  any knob to save your changes.
10. Press the  **Confirm** knob to commit the change. Press the  **Cancel** knob to discard the change and return to the previous setting.

#### Note:

- The device you are adding may require additional setup parameters. Refer to the *Ross Video External Device Setup Sheet* for your particular device for complete connection and configuration information.

#### To edit a device:









1. Press  **MENU**.
2. Press the  **SYSTEM** Wipe Pattern button.
3. Press  **NEXT** until **Device Config** is displayed.
4. Press the  **Device Config** knob to display the **Device Configuration** menu.
5. Use the  **Add** knob to select the device to edit.
6. Press the  **Edit** knob to display the **Device Edit** menu.

7. Use the  knobs to edit the device settings as necessary.
8. Press  any knob to save your changes.
9. Press the  **Confirm** knob to commit the change. Press the  **Cancel** knob to discard the change and return to the previous setting.







#### Note:



- The device you are editing may require additional setup parameters. Refer to the *Ross Video External Device Setup Sheet* for your particular device for complete connection and configuration information.

#### To remove a device:

1. Press  **MENU**.
2. Press the  **SYSTEM** Wipe Pattern button.
3. Press  **NEXT** until **Device Config** is displayed.
4. Press the  **Device Config** knob to display the **Device Configuration** menu.
5. Use the  **Add** knob to select the device to remove.
6. Press the  **Delete** knob to remove the device.
7. Press the  **Confirm** knob to commit the change. Press the  **Cancel** knob to discard the change and return to the previous setting.

#### To assign a device to an input:

1. Press  **MENU**.
2. Press the  **CONFIG** Wipe Pattern button.
3. Press the  **Input** knob to display the **Input** menu.
4. Press  **NEXT** until **Device** is displayed.
5. Use the  **Input** knob to select the input you wish to assign the device to.
6. Press the  **Device** knob to display the **Device** menu.
7. Use the  **Device** knob to select the device to assign to the selected input.



8. Press the  **Device** knob to save your selection.
9. Press the  **Confirm** knob to commit the change. Press the  **Cancel** knob to discard the change and return to the previous setting.

## Cameras

You can control the orientation, lens effects, and shot storage and recall of an external camera.

- ★ *You may experience unresponsive camera controls for a short period of time immediately after loading switcher settings from a USB drive, rebooting, or performing a switcher software upgrade.*





### To control camera orientation:

1. Select the input source that has been associated with your camera.
2. Use the  **Pan** knob to pan the camera left and right.
3. Use the  **Tilt** knob to tilt the camera up and down.
4. Use the  **Zoom** knob to zoom the camera lens in and out.

### Note:



- You can also use the positioner on the CrossOver 12 to control camera pan and tilt. This works from any camera control menu.

### To control camera focus and iris:

1. Select the input source that has been associated with your camera.
2. Press  **NEXT** until **Focus** is displayed.
3. Press the  **Focus** knob to toggle between auto and manual focus modes.
4. When in manual focus mode, use the  **Focus** knob to focus the camera.
5. Press the  **Iris** knob to toggle between auto and manual iris modes.
6. When in manual iris mode, use the  **Iris** knob to control the lens iris size.

### To store a shot:



1. Select the input source that has been associated with your camera.
2. Set the camera orientation, focus, and iris settings as required.

3. Press  **NEXT** until **Store** is displayed.
4. Use the  **Store** knob to select a shot number to store.
5. Press the  **Store** knob to store the shot.

### Note:

- The shot number defaults to the last recalled shot.

### To recall a shot:

1. Select the input source that has been assigned to your camera.
2. Set the camera orientation, focus, and iris settings as required.
3. Press  **NEXT** until **Recall** is displayed.
4. Use the  **Recall** knob to select a shot number to recall.
5. Press the  **Recall** knob to recall the shot.

### Note:

- You can not recall a second shot while a shot is being recalled. Wait for the first recall to finish before attempting to recall another shot.
- The shot number defaults to the last recalled shot.
- When you store a memory register, the last recalled shot is stored in the memory register and is recalled when the memory register is recalled.







### For More Information on...

- storing and recalling memory registers, refer to the section “Memory System Overview” on page 5-1.

### Inverting Camera Axes

You can selectively invert the camera pan and tilt axes on a per-input basis.

### To invert camera axes:

1. Press  **MENU**.
2. Press the  **CONFIG** Wipe Pattern button.
3. Press the  **Input** knob to display the **Input** menu.
4. Use the  **Input** knob to select the input that the camera is assigned to.
5. Press  **NEXT** until **Device** is displayed.
6. Press the  **Device** knob to display the **Device** menu.

7. Press **NEXT** until **Option** is displayed.
8. Use the **Option** knob to select **Invert Pan**.
9. Use the **Value** knob to set whether the pan axis is inverted. You can choose from the following:
  - **No** — The axis is not inverted. This is the default value.
  - **Yes** — The axis is inverted.
10. Use the **Option** knob to select **Invert Tilt**.
11. Use the **Value** knob to set whether the tilt axis is inverted. You can choose from the following:
  - **No** — The axis is not inverted. This is the default value.
  - **Yes** — The axis is inverted.

### AMP Protocol Devices

You can control devices that support the AMP protocol. Currently, only the **play** command is supported. Clips must be pre-loaded on the video server.

Typically, the AMP device plays the clip when the input it is assigned to is part of a transition. The clip plays as soon as the transition starts, the switcher waits for the defined pre-delay and then takes the sources to air.

You can also issue the **play** command manually.

#### To manually play a clip:

1. Select the input source that has been associated with your video server.
2. Press the **Play** knob to play the clip.

### General Purpose Interface (GPI)

The switcher has 24 GPI inputs/outputs corresponding to the pins on the GPI port. The GPI inputs/outputs are arranged into 3 banks.



Figure 4.3 GPI Port

Banks configured as GPI inputs are used to trigger memory recalls, transitions, and Aux bus input changes.

Banks configured as GPI outputs allow your switcher to trigger actions on external devices.

#### To configure GPI banks:

1. Press **MENU**.
2. Press the **CONFIG** Wipe Pattern button.
3. Press the **GPIO** knob to display the **GPIO** menu.
4. Use the **Bank** knob to select the GPI bank you wish to configure.
5. Use the **I/O** knob to select whether the bank is configured as GPI inputs or outputs. You can choose from the following:
  - **GPO** — The bank is configured as GPI outputs.
  - **GPI** — The bank is configured as GPI inputs.

#### Note:

- Every pin in the selected bank initially goes low when you change the bank from a GPI output to GPI input.

### GPI Output Banks

Banks configured as GPI outputs have output pins assigned as follows (Pin 1 is the top right pin when looking at the GPI Port).



Figure 4.4 GPI Port

#### To configure a GPI output bank:

1. Press **MENU**.
2. Press the **CONFIG** Wipe Pattern button.
3. Press the **GPIO** knob to display the **GPIO** menu.
4. Use the **Bank** knob to select a GPI bank configured as GPI outputs.
5. Press **NEXT**.
6. Use the **Pin** knob to select which GPI output pin to configure.



7. Use the **Type** knob to select the GPI output level and trigger type. You can choose from the following:

- **LowE** — The output level is set high, and momentarily goes low for the trigger.

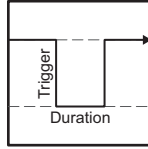

- **HighE** — The output level is set low, and momentarily goes high for the trigger.

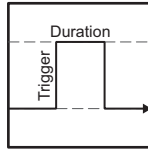

- **LowL** — The output level toggles from the base high level to the low level. The output signal remains at this level until reset

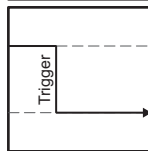

- **HighL** — The output toggles from the base low level to the high level. The output signal remains at this level until reset.

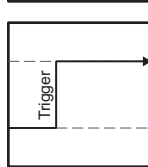

8. If you selected either **LowE** or **HighE** in the previous step, use the **Dur** knob to set the length (in frames) that the GPI output remains triggered.

**Note:**

- Edge triggered GPI outputs remain triggered for the configured duration.
- Level triggered GPI outputs toggle between latched and unlatched each time you press the corresponding Wipe Pattern button.
- Changing the configuration of a GPI output pin that is currently latched causes it to unlatch.

**GPI Input Banks**

Banks configured as GPI inputs have inputs assigned as follows (Pin 1 is the top right pin when looking at the GPI Port).

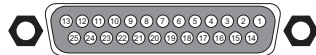

**Figure 4.5** GPI Port

**Table 4.5** GPI Port GPI Input Mapping

Pin	Trigger
<b>Bank 1</b>	
1	Dissolve Key 1
2	Dissolve Key 2
3	Dissolve Key 3 (CrossOver 12 only)
4	Perform Auto Transition

**Table 4.5** GPI Port GPI Input Mapping

Pin	Trigger
5	Perform Program / Preset Bus cut
6	Perform Key 1 cut
7	Perform Key 2 cut
8	Perform Key 3 cut (CrossOver 12 only)
<b>Bank 2</b>	
9	Perform Fade to Black
10	Set Aux Bus 1 to Input 1
11	Set Aux Bus 1 to Input 2
12	Set Aux Bus 1 to Input 3
13	Set Aux Bus 1 to Input 4
14	Set Aux Bus 1 to Input 5
15	Recall Memory 0 <sup>a</sup>
16	Recall Memory 1 <sup>a</sup>
<b>Bank 3</b>	
17	Recall Memory 2 <sup>a</sup>
18	Recall Memory 3 <sup>a</sup>
19	Recall Memory 4 <sup>a</sup>
20	Recall Memory 5 <sup>a</sup>
21	Recall Memory 6 <sup>a</sup>
22	Recall Memory 7 <sup>a</sup>
23	Recall Memory 8 <sup>a</sup>
24	Recall Memory 9 <sup>a</sup>
<b>Not Assigned to a Bank</b>	
25	Ground

a. Only memory registers from memory bank 0 can be recalled with a GPI trigger.

**Note:**

- GPI input pin assignments are not user-configurable.

**For More Information on...**

- port locations, refer to the section “Frame Rear Connections Overview” on page 1-3.

**Triggering GPI Outputs**

You can trigger GPI outputs manually or automatically.

## Automatically Triggering a GPI Output







You can associate a GPI output with an input source, Media-Store channel, or matte. The GPI output is triggered whenever the associated source is taken to air.

A user-configurable delay may also be set for each input that inserts a delay after the GPI output is triggered but before the source is taken to air. This is useful for VTR pre-roll delay and other situations where an input source is not immediately ready to take to air.

### Note:

- It is recommended to assign edge triggered GPI outputs to input sources.

### To associate a GPI output with an input source:

- Press  **MENU**.
- Press the  **CONFIG** Wipe Pattern button.
- Press the  **Input** knob to display the **Input** menu.
- Press  **NEXT** until **GPO** is displayed.
- Use the  **Input** knob to select an input source.
- Use the  **GPO** knob to select a GPI output to associate with the selected input source.
- Use the  **Predly** knob to set the pre-delay interval (in frames) that the switcher waits after the GPI output is triggered before taking the input source on-air.





### Note:

- You can not assign a GPI output to the Aux bus special sources (**AUX PGM**, **AUX PV**, **AUX CLN**, or **AUX ALPHA**)

## Overriding an Automatically Triggered GPI Output

You can quickly disable a GPI output trigger before a transition is performed.

### To disable the GPI output trigger:

- Prepare a transition using  **DISS**,  **WIPE**, or  **DVE** as the transition type, but do not perform the transition.
- Use the  **RIClip** knob to control whether the switcher triggers the GPI output before

performing a transition. You can choose from the following:

- Off** — The GPI output is not triggered and the pre-delay is ignored. The transition is performed immediately.
- On** — The GPI output is triggered and the switcher pauses for the pre-delay before performing the transition.

### Note:

- The **RIClip** personality option must be set to **User** for you to override GPI output triggering.

### For More Information on...

- setting the **RIClip** personality option, refer to the section “Transition Area Behavior” on page 2-13.



## Manually Triggering a GPI Output

You can manually trigger GPI outputs by holding down the **NEXT** button and then pressing a Wipe Pattern button corresponding to the GPI output you wish to trigger. The Wipe Pattern button mapping is shown in Table 4.6.

**Table 4.6 Wipe Pattern Button GPI Output Mapping**

Wipe Pattern Button	GPI Output Pin		
	Bank 1	Bank 2	Bank 3
<b>STATUS (0)</b>	1	9	17
<b>OPTION (1)</b>	2	10	18
<b>SYSTEM (2)</b>	3	11	19
<b>REF (3)</b>	4	12	20
<b>CONFIG (4)</b>	5	13	21
<b>RESET (5)</b>	6	14	22
<b>USER (6)</b>	7	15	23
<b>PERS (7)</b>	8	16	24

### To manually trigger a GPI output:

- Ensure that the  **NEXT** button secondary function is set to **GPO**.
- Press and hold  **NEXT**.
- Press the Wipe Pattern button corresponding to the GPI output you wish to trigger.

### Note:

- While holding the  **NEXT** button, the states of all GPI outputs in the selected bank are displayed.

The corresponding Wipe Pattern button is lit for each GPI output that is currently triggered.

- Edge triggered GPI outputs remain triggered for the configured duration.
- Level triggered GPI outputs toggle between latched and unlatched each time you press the corresponding Wipe Pattern button.
- If the GPI bank associated with the  **NEXT** button secondary function is not configured as a GPI output bank, you are not able to manually trigger GPI outputs.

**For More Information on...**

- configuring the **NEXT** button secondary function, refer to the section “NEXT button Secondary Function” on page 2-13.

### Transition Pre-Delay







Inputs with assigned AMP devices or GPI outputs cause the switcher to wait for the defined pre-delay time before a transition takes the sources to air.

During the pre-delay time, you can override the countdown and cut the Program or Key bus on-air immediately. Alternately, you can abort the pending transition.

**To override the pre-delay countdown and perform a transition:**

1. Initiate a transition that causes an input with an assigned GPI output or AMP device to be taken on-air.
2. While the switcher is waiting for the pre-delay countdown to complete, perform one of the following:
  - Press the source button on the Program bus that is going-on air. The pre-delay countdown and the transition are aborted and the source is cut to air on the Program bus.
  - Initiate a transition with the fader handle. The pre-delay countdown is aborted and the transition proceeds as you move the fader handle.

**To abort the transition and override the pre-delay countdown:**

1. Initiate a transition that causes an input with an assigned GPI output or AMP device to be taken on-air.
2. While the switcher is waiting for the pre-delay countdown to complete, perform one of the following:
  - Press any source button on any bus other than the source button on the Program bus that is going-on air.
  - Press  **BKGD**,  **Key 1**,  **Key 2**, or  **Key 3** in the next transition area.
  - Press  **CUT** or  **AUTO TRANS**.
  - If a key is included in the transition, press a dedicated key transition button.
  - Recall a memory register. The pre-delay countdown and transition are aborted and the memory register is recalled.

**For More Information on...**

- configuring pre-delay for GPI outputs, refer to the section “Triggering GPI Outputs” on page 4-15.
- configuring pre-delay for AMP devices, refer to the *Ross Video External Device Setup Sheet* for your AMP device.
- recalling a memory register, refer to the section “Recalling Memory Registers” on page 5-4

### Editor Port

The switcher has an Editor port that allows you to attach an external editor, GearLite TSC-9902 LTC to Serial Converter, or other device.

The pinout is as follows:



**Figure 4.6** Editor Port

**Table 4.7** Editor Port Pinout

Pin	Input
1	Not Connected
2	Tx-
3	Rx+
4	Ground

**Table 4.7 Editor Port Pinout**

5	Ground
6	Not Connected
7	Tx+
8	Rx-
9	Not Connected

### Supported Editors

The following editors have been tested:

- Editware LE-2000 Series
- Sony BVE-900/910
- Sony BVE-2000

#### For More Information on...

- GVG100 protocol support, refer to the section “GVG100 Protocol Supported Commands” on page 8-3.
- LiveEDL, refer to the section “Live Edit Decision Lists (EDL)” on page 4-7
- port locations, refer to the section “Frame Rear Connections Overview” on page 1-3.

# Memories, USB Storage, and Upgrades

This chapter describes the internal memory system and how to transfer information to and from your switcher via the USB interface.

## Memory System Overview



The built-in memory system contains 100 memory registers (10 banks of 10 registers).

### Memory Access Mode

There are two ways to access the memory system:

- **Direct Access Mode** — You can access any of the 100 memories by pressing two buttons (one for the bank and one for the memory location).
- **Bank Mode** — You pre-select a bank and then access any of the 10 memories in that bank with a single button press.



**To set the Memory Access Mode attribute:**



1. Press  **STORE**.
2. Use the  **Mode** knob to select the memory access mode. You can choose from the following:
  - **DirAcc** — Use Direct Access Mode.
  - **Bank** — Use Bank Mode.

## Memory Attributes





There are several attributes you can set to control how the switcher stores and recalls memory registers. Each attribute can be set individually for each memory register. When recalling a memory register, you can select whether each attribute is replaced with the value stored in the memory register or retains the current value.

**To set storage memory attributes**

1. Press  **STORE**.
2. Press  **NEXT**.
3. Use the  **Attrib** knob to select the memory attribute you wish to set.

4. Use the  middle knob to select the component that you want to apply the attributes to.
5. Use the  **Value** knob to select the how you want to memory attributes to be stored in the memory. Refer to the following sections for information on each attribute.

**To set recall memory attributes**

1. Press  **RECALL**.
2. Press  **NEXT**.
3. Use the  **Attrib** knob to select the memory attribute you wish to set.
4. Use the  middle knob to select the component that you want to apply the attributes to.
5. Use the  **Value** knob to select the how you want to memory attributes to be recalled. Refer to the following sections for information on each attribute.

### Recall Mode

Recall Mode sets the memory recall mode.

- **Memory (Recall Only)** — The memory attributes stored in the memory are used.
- **PGM** — All attributes are recalled to the exact state they were in when stored in the memory register. This is the default behavior.
- **PV** — Only those elements not currently on-air are recalled. The Preset bus is recalled while the Program bus is not.
- **MemAI** — The switcher uses the contents of the memory register to configure the Next Transition area and the Preset bus. The switcher is configured such that the next transition will make the on-air state the same as the state saved in the memory register.
- **DVEDis** — The switcher interpolates all DVE parameters between the current state and the state in the memory register and smoothly transitions between them over a user-configurable duration.

Only DVE key parameters are recalled and this Recall Mode applies only to DVE keys.

- **EffDis** — The Effects Dissolve feature allows you to slew from one memory to another using a memory recall. The switcher will interpolate from the starting memory to the destination memory, creating a smooth, two keyframe effect.

The following elements can be interpolated in the effects dissolve:

- › Matte colors (background, wash or borders)
- › Keyer settings like clip, gain, transparency
- › Mask position and size
- › Chroma key settings, except the background color
- › Pattern settings like size, position, aspect, border, softness, rotation
- › DVE settings like size, position, aspect, border, softness, cropping
- › MediaStore x/y position
- › Transition Progress

Other elements, such as key priority, crosspoint selection, pattern, and next transition data are recalled first, and then the switcher will slew to the recalled memory.

An effects dissolve can be performed on as many elements as required, based on the memory that is being recalled.

### Effects Dissolve Duration (EffDur)

EffDur Sets the duration of an Effects Dissolve memory recall. This attribute is only applicable when the **Mode** attribute is set to **EffDiss**.

- **Memory (Recall Only)** — The memory attributes stored in the memory are used.
- **1-999fr** — Sets the duration of the effects dissolve, in frames.

### Program Bus Recall (PGMBus)

PGMBus sets whether the sources selected on the Background/Program bus, when the memory was stored, are recalled with the memory.

- **Memory (Recall Only)** — The memory attributes stored in the memory are used.
- **NoRcl** — The sources stored in the memory are not recalled.
- **Recall** — The sources that were stored in the memory are recalled and replace the currently selected source on the Program bus. This is the default setting.

### Preset Bus Recall (PSTBus)

PSTBus sets whether sources selected on the Preset bus, when the memory was stored, are recalled with the memory.

- **Memory (Recall Only)** — The memory attributes stored in the memory are used.
- **NoRcl** — The sources stored in the memory are not recalled.
- **Recall** — The sources that were stored in the memory are recalled and replace the currently selected source on the Preset bus. This is the default setting.

### Transition Area Recall (Trans)

Trans sets whether the Transition Parameter and Transition Type buttons, but not the Fader, Transition or Next Transition Select buttons, are recalled with the memory.

- **Memory (Recall Only)** — The memory attributes stored in the memory are used.
- **NoRcl** — The sources stored in the memory are not recalled.
- **Recall** — The sources that were stored in the memory are recalled and replace the currently selected source on the Preset bus. This is the default setting.

### Next Transition Recall (NextTr)

NextTr sets whether the selections of the Next Transition Select buttons in the Transition Area are recalled with the memory.

- **Memory (Recall Only)** — The memory attributes stored in the memory are used.
- **NoRcl** — The selections stored in the memory are not recalled.
- **Recall** — The selections that were stored in the memory are recalled and replace the currently settings of the Next Transition Select buttons. This is the default setting.

### Run Auto Transition (RnAuto)

RnAuto sets whether an auto transition is performed after a memory is recalled. Remember to set up the transition in the Transition Area when you store the

memory so that the desired transition is performed after the memory is recalled.

- **Memory (Recall Only)** — The memory attributes stored in the memory are used.
- **NoRun** — A transition is not performed after the memory is recalled. This is the default setting.
- **Run** — An auto transition is performed after the memory is recalled.

### Shared Pattern Recall (SrdPat)

SrdPat sets whether the pattern generator that is shared between the key masks and washes is recalled.

- **Memory (Recall Only)** — The memory attributes stored in the memory are used.
- **NoRcl** — The pattern generator is unchanged by the memory recall.
- **Recall** — The pattern generator settings may be recalled with the memory. Other attributes can prevent the pattern generator from recalling. This is the default setting.

### Key Bus Recall (KeyBus)

KeyBus sets whether the sources selected on the Keyer bus, when the memory was stored, are recalled with the memory.

- **Key** — Selects the keyer you want to set the memory attribute for.
- **Memory (Recall Only)** — The memory attributes stored in the memory are used.
- **NoRcl** — The sources stored in the memory are not recalled.
- **Recall** — The sources that were stored in the memory are recalled and replace the currently selected source on the key bus. This is the default setting.

### Key Active Recall (KActiv)

KActiv sets whether the on-air status of the keyer is recalled with the memory. For example, if a key is on-air in a memory, but off-air before the recall, the key will not be cut on-air with the recall if **KActiv** is set to **NoRcl**.

The operation of the Key Active attribute is effected by the Memory AI feature.

- **Key** — Selects the keyer you want to set the memory attribute for.
- **Memory (Recall Only)** — The memory attributes stored in the memory are used.
- **NoRcl** — The on-air status of the selected keyer is not recalled.
- **Recall** — The on-air status of the selected keyer is recalled with the memory. Keys may be cut on or off-air with the memory recall. This is the default setting.

### Key Type Recall (KType)

KType sets whether the key type is recalled with a memory.

- **Key** — Selects the keyer you want to set the memory attribute for.
- **Memory (Recall Only)** — The memory attributes stored in the memory are used.
- **NoRcl** — The key type stored in the memory for the selected keyer is not recalled with the memory. If the current key type does not match the key type in the memory, none of the key parameters, except on-air state, are recalled.
- **Recall** — The key type stored in the memory for the selected keyer is recalled with the memory. This is the default setting.

### Key Mask Recall (KMask)

KMask sets whether key mask settings are recalled with a memory. Refer to the section “Shared Pattern Recall (SrdPat)” on page 5-3 for information on the shared pattern mask for keyers.

- **Key** — Selects the keyer you want to set the memory attribute for.
- **Memory (Recall Only)** — The memory attributes stored in the memory are used.
- **NoRcl** — The key mask settings stored in the memory for the selected keyer are not recalled with the memory.
- **Recall** — The key mask settings stored in the memory for the selected keyer are recalled with the memory. This is the default setting.

## Media

Media sets whether stored images or animations are recalled when you recall the memory register.

- **Media1/2/3/4** — Selects the Media-Store channel you wish to configure. The listed Media-Store channels depend on the Media-Store mode.
- **Recall** — The image or animation that was stored in the memory register is recalled and replaces the currently loaded image or animation. This is the default setting.
- **NoRcl** — The stored image or animation is not recalled.

## Aux

Aux sets whether the stored input source of an Aux bus is recalled when you recall the memory register.

- **Aux 1-4** — Selects the Aux bus you want to configure.
- **Recall** — The input source that was stored in the memory register is recalled and replaces the currently selected source on the Aux bus. This is the default setting.
- **NoRcl** — The stored source input is not recalled.

## Camera Recall (CamRcl)

CamRcl sets whether the stored camera shot is recalled when you recall the memory register.

- **Recall** — The camera shot that was stored in the memory register is recalled and replaces the current camera shot.
- **NoRcl** — The stored camera shot is not recalled. This is the default setting.

## Roll GPO (RIIGPO)

RIIGPO sets whether any GPI outputs attached to the stored input sources are triggered when you recall the memory register. the memory recall mode.

- **Roll** — GPI outputs attached to input sources stored in the memory register are triggered. This is the default setting.
- **NoRoll** — GPI outputs attached to input sources stored in the memory register are not triggered.

## Roll VTR (RIIVTR)

RIIVTR sets whether the AMP Play command is triggered when a stored input source that is assigned to an AMP compatible video server is recalled.

- **Roll** — The AMP Play command is triggered, the preroll delay occurs and then the memory register is recalled. This is the default setting.
- **NoRoll** — The AMP Play command is not triggered and the preroll delay is ignored.



### For More Information on...

- setting transition rate units, refer to the section “Transition Rate Units” on page 2-10.

## Storing Memory Registers

Storing settings to a memory register allows you to save an effect for re-use.

### To store a setting to a memory register:

1. Press the  **STORE** button.
2. Select the storage area you wish to save to as follows:
  - If you are using Bank Mode, press a Wipe Pattern button to select a memory register in the current bank. You may also use the  **Bank** knob to select a different bank before storing.
  - If you are using Direct Access Mode, press a Wipe Pattern button to select the desired bank and then press a second Wipe Pattern button to select a memory register.

### Note:

- You can exit without storing a memory register by pressing any button other than a Wipe Pattern, dedicated key transition, **CUT**, **AUTO TRANS**, or source button.
- The switcher is set to recall memory registers immediately after storing a memory register.

## Recalling Memory Registers

Recalling the memory register allows you to quickly re-use the effect you previously stored.

### To recall a setting from a memory register:

1. Press  **RECALL**.
2. Select the memory register you wish to recall from as follows:
  - If you are using Bank Mode, press a Wipe Pattern button to select a memory register in



the selected bank. You may also use the  **Bank** knob to select a different bank before recalling.

- If you are using Direct Access Mode, press a Wipe Pattern button to select the desired bank and then press a second Wipe Pattern button to select a memory register.

**Note:**



- Recalling a memory register that requires a new image to be loaded from a USB drive into a Media-Store channel may result in the currently loaded image being displayed for a few frames while the new image is loaded.
- Recalling a memory register that includes a source assigned to a camera also recalls the shot stored in the memory register for that camera if the **CamRcl** memory attribute is set to **Recall**. There is no delay in the memory recall so camera movement may be visible while the shot is recalled.
- You can exit without recalling a memory register by pressing any button other than a Wipe Pattern, dedicated key transition, **CUT**, **AUTO TRANS**, or source button.

**Bus Hold**

You can choose to have a bus remain unaffected by a memory recall (the selected source on the bus is not replaced with the source stored in the memory).

A bus hold is equivalent to having the bus (PGM Bus, PST Bus, Key Bus, KActiv, KType, and KMask) attribute set to no recall.

**To perform a Bus Hold:**

1. Press and hold the desired source button on the Program, Preset, or Key/Aux bus.
2. Press  **RECALL**.
3. Select the memory register you wish to recall from as follows:
  - If you are using Bank Mode, select a pattern button to designate the memory register in the selected bank. You may also use the  **Bank** knob to change the selected bank before storing.
  - If you are using Direct Access Mode, select a pattern button to designate the desired bank and then select a second pattern to designate the memory register.

The source on the bus you selected will not change when the memory is recalled (the source

setting stored in the memory for that bus is ignored).

**Memory AI and Keys**

Enabling Memory AI mode changes the way key elements are recalled. If a key is currently on-air, the element for that key is recalled in the next available off-air key. If there is no available off-air keys, the element is not recalled.

All resource sharing is set to **FLOAT** mode so that key elements may be recalled to other keys than originally stored.

**For More Information on...**

- resource sharing, refer to the section “Resource Sharing” on page 2-11.

**Memory Recall Scenarios**

Table 5.1 shows the contents of a memory register and the state of the switcher in various scenarios.

**Table 5.1 Recall to Preview Scenarios**

Element	Memory Register	Scenario	
		1	2
<b>PST Bus</b>	Input 2	Any Input	Any Input
<b>PGM Bus</b>	Input 3	Input 1 (on-air)	Input 1 (on-air)
<b>Key 1 (set as a DVE key)</b>	Input 4 (on-air)	Input 6 (on-air)	Any Input
<b>Key 2</b>	Input 5	Any Input	Any Input
<b>Key 3</b>	Any Input	Any Input	Any Input

Depending on the Memory Recall mode setting, the elements recalled are as follows:

**Recall Mode: PGM (Program)**

- Scenario 1
  - › Input 2 is recalled to the Preset bus.
  - › Input 3 is recalled to the Program bus (on-air image instantly cuts to Input 3).
  - › Input 4 is recalled to Key 1 (on-air image instantly cuts to Input 4).
  - › Input 5 is recalled to Key 2 (on-air image not affected as Key 2 is off-air).
- Scenario 2 has the same behavior has Scenario 1.

**Recall Mode: PV (Preview)**

- Scenario 1
  - › Input 2 is recalled to the Preset bus.

- › Input 3 is not recalled to the Program bus (on-air image is not affected).
- › Input 4 is not recalled to Key 1 as Key 1 is on-air (on-air image is not affected).
- › Input 5 is recalled to Key 2 (on-air image is not affected as Key 2 is off-air).
- Scenario 2
  - › Input 2 is recalled to the Preset bus.
  - › Input 3 is not recalled to the Program bus (on-air image is not affected).
  - › Input 4 is recalled to Key 1 (on-air image is not affected as Key 1 is off-air).
  - › Input 5 is recalled to Key 2 (on-air image is not affected as Key 2 is off-air).

#### Recall Mode: MemAI (Memory AI)

- Scenario 1
  - › Input 3 is recalled to the Preset bus (on-air image is not affected).
  - › Input 4 is recalled to Key 2 as Key 1 is on-air (on-air image is not affected).
  - › CrossOver 12: Input 5 is recalled to Key 3 as Key 2 is now in-use (on-air image is not affected).
  - › CrossOver 6: Input 5 is not recalled as both keys are now in use.
  - › Next Transition area is set to transition background, Key 1 and Key 2. (CrossOver 12 only)
- Scenario 2
  - › Input 3 is recalled to the Preset bus (on-air image is not affected).
  - › Input 4 is recalled to Key 1 (on-air image is not affected).
  - › Input 5 is recalled to Key 2 (on-air image is not affected).
  - › Next Transition area is set to transition background, Key 1, and Key 2.

#### Recall Mode: DVEDis (DVE Dissolve)







- Scenario 1
  - › Only the DVE parameters of Key 1 are recalled and the switcher performs a smooth effects dissolve between the current DVE parameters and the DVE parameters stored in the memory. No other properties are recalled.
- Scenario 2 has the same behavior as Scenario 1.

#### Recall Mode: EffDis (Effects Dissolve)

- Scenario 1
  - › Input 2 is recalled to the Preset bus.

- › Input 3 is recalled to the Program bus (on-air image dissolves to Input 3).
- › Input 4 is recalled to Key 1 (on-air image dissolves to Input 4 and slews to new location).
- › Input 5 is recalled to Key 2 (on-air image not affected as Key 2 is off-air).
- Scenario 2 has the same behavior as Scenario 1.

#### To set the Recall mode:

1. Press  **RECALL**.
2. Press  **NEXT** until **Attrib** is displayed.
3. Use the  **Attrib** knob to select **Recall Mode**.
4. Use the  **Value** knob to select the Memory Recall mode. You can choose from the following:
  - **PGM** — Program mode.
  - **PV** — Recall to Preview mode.
  - **MemAI** — Memory AI mode.
  - **EffDiss** — Effects Dissolve mode.
  - **Memory** — The Memory Recall mode stored in the memory register being recalled is used.
5. If you are using the **EffDiss** Memory Recall mode, set the desired transition time as follows:
  - Use the  **Attrib** knob to select EffDur.
  - Use the  **Value** knob to select the duration of the Effects Dissolve transition.

## USB Storage

You can use a USB drive to:

- Save and load sets of memory registers, personality, and installation settings to and from a USB drive
- Perform software upgrades

These files and settings can be copied from the USB drive and backed-up on your computer.

#### Note:

- If you are transferring large files to the USB drive via the FTP interface, do not perform any other tasks that require the USB drive until the transfer has finished.
- Wait 5 seconds after inserting a USB drive into the USB port before using it.











#### For More Information on...

- performing software upgrades, refer to the section “Software Upgrades” on page 5-8.
- FTP access to the USB drive, refer to the section “Creating an FTP Connection” on page 4-6.

### Saving Switcher Settings

You can save up to 10 sets of memory registers, personality settings, and installation settings on a USB drive.

#### To save to a USB drive:

1. Insert a USB drive into the USB port.
2. Press  **MENU**.
3. Press the **SAVE** Wipe Pattern button.
4. Use the  left knob to select the set you wish to save to.
5. Select the register you want to save as follows:
  - **All** — Press the  **All** knob to save all registers to the selected set.
  - **Memories** — Press the  **Mems** knob to save memory registers to the selected set.
  - **Custom Controls** — Press the  **Cust** knob to save custom control registers to the selected set.
  - Press  **NEXT**.
  - **Personality** — Press the  **Pers** knob to save personality settings to the selected set.
  - **Installation** — Press the  **Inst** knob to save installation settings to the selected set.
6. Press the  **Confirm** knob to perform the save. Press the  **Cancel** knob to cancel the save.

#### Note:

- Turn the middle knob when browsing sets to display the full text of long set names
- Saving items overwrites the same items in the selected set (e.g. saving memory registers overwrites previously saved memory registers in the selected set but does not affect personality or installation settings previously saved to the same set).
- The \* symbol next to an item indicates that there is a previously saved version of that item in the selected set.

#### For More Information on...











- accessing the USB port, refer to the section “Frame Overview” on page 1-3.

### Loading Switcher Settings

You can load switcher settings that were previously saved to a USB drive.

- ★ *Memory registers that were empty when saved will erase the contents of the same memory register on your switcher when loaded from a USB drive.*

#### To load from a USB drive:

1. Insert a USB drive containing memory register, personality, and installation sets into the USB port.
2. Press  **MENU**.
3. Press the  **LOAD** Wipe Pattern button.
4. Use the  left knob to select the set you wish to load from.
5. Select the register you want to load as follows:
  - **All** — Press the  **All** knob to load all registers from the selected set.
  - **Memories** — Press the  **Mems** knob to load memory registers from the selected set.
  - **Custom Controls** — Press the  **Cust** knob to load custom control registers from the selected set.
  - Press  **NEXT**.
  - **Personality** — Press the  **Pers** knob to load personality settings from the selected set.
  - **Installation** — Press the  **Inst** knob to load installation settings from the selected set.
6. Press the  **Confirm** knob to perform the save. Press the  **Cancel** knob to cancel the save.

#### Note:

- Turn the middle knob when browsing sets to display the full text of long set names
- The \* symbol next to an item indicates that there is a previously saved version of that item in the selected set.

#### For More Information on...









- accessing the USB port, refer to the section “Frame Overview” on page 1-3.

## Software Upgrades

Software upgrades stored on a USB drive can be uploaded to the switcher.

- ★ **Do not turn the switcher power off during the upgrade.**

### To upgrade the switcher software:

1. Copy a software upgrade file onto a USB drive.
2. Insert the USB drive with the software upgrade file into the USB port.
3. Press  **MENU**.
4. Press the  **RESET** Wipe Pattern button.
5. Press  **NEXT** until **Run Software Upgrade From USB** is displayed.
6. Press the  left knob to display the **Upgrade** menu.
7. Select an upgrade file to use as follows:
  - Use the  left knob to browse the USB drive file system. Turning the knob cycles through all the files and directory names at the current level in the file system.
  - Navigate to sub-directories by selecting a sub-directory name and then pressing the  left knob. Sub-directories are displayed as **<directory-name>**
  - Return to a parent directory by selecting **<.>**.
  - Use the left knob to select the upgrade file you wish to use.
8. Press the  left knob to load the upgrade file.
9. Press the  **Confirm** knob to initiate an upgrade. Press the  **Cancel** knob if you do not wish to perform an upgrade.

The menu displays a message indicating the software upgrade is in progress. The **Upgrade** LED on the rear of the switcher is lit, indicating an upgrade is in progress.

### Note:

- Wait 5 seconds after inserting a USB drive into the USB port before using it.
- Turn the middle knob when browsing the file system to display the full text of long directory lists and filenames.
- Upgrades can take several minutes to complete.
- If **CRITICAL UPGRADE** is displayed, the switcher is performing an upgrade that includes

low-level software components. This does not indicate a problem with your switcher.

### For More Information on...

- accessing the USB port, refer to the section “Frame Overview” on page 1-3.

## Completing a Software Upgrade

When the software upgrade is complete, the menu displays a message indicating the software upgrade was successful, the Upgrade LED on the rear of the switcher turns off, and the switcher performs an automatic restart.

Once the switcher restarts, it is ready to use. You can then safely remove the USB drive.

### Note:

- If you are upgrading a switcher as a result of a corrupt configuration or a previously failed upgrade, you may need to reconfigure the network address and reload switcher memories.

### For More Information on...

- configuring the network address of your switcher, refer to the section “IP Address” on page 2-8.
- reloading switcher memories, refer to the section “Recalling Memory Registers” on page 5-4.

# Media-Store

Your switcher has 4 Media-Store channels which allow you to display 2 images or animations (composed of a sequence of images) with accompanying alpha-channels on-air simultaneously.

## Media-Store Overview

Images and animations are assigned unique Media numbers that allow the switcher to identify them. You can load images and animations into Media-Store channels by:

- browsing the internal file system of the switcher or connected USB drive.
- creating an FTP connection to your switcher from a computer and uploading images or animations.
- using the Wipe Pattern buttons to specify Media numbers for images or animations that have been loaded previously.

## Media-Store Modes

You can set your switcher to have either 2 or 4 Media-Store channels. You can display 2 images or 1 image with an alpha-channel when your switcher is set to 2 Media-Store channels. You can display 2 images with alpha-channels when your switcher is set to 4 Media-Store channels.

**To configure Media-Store mode:**







1. Press  **MENU**.
2. Press the  **SYSTEM** Wipe Pattern button.
3. Press  **NEXT** until **Media** is displayed.
4. Use the  **Media** knob to select the Media-Store mode. You can choose from the following:
  - **Tall** — Two channels of Media-Store are available. Each channel can contain an image or Channel 1 can contain an image and an associated alpha-channel is contained in Channel 2.
  - **Dual** — Four channels of Media-Store are available. Each channel can contain a separate image, or Channel 1 can contain an image and an associated alpha-channel in Channel 3, and Channel 2 can contain an

image and an associated alpha-channel in Channel 4.

- **Swish** — Two channels of Media-Store are available. Each channel can contain an image or Channel 1 can contain an image and an associated alpha-channel in Channel 3. Channels 2 and 4 are reserved for Media Transitions.
- **Swish+** — Four channels of Media-Store are available. Channel 2 (video) and Channel 4 (alpha) can also be used for media transitions. Channels 1 and 3 are not reserved.

5. Press the  **Media** knob to save your selection.
6. Press the  **Confirm** knob to commit the change. Press the  **Cancel** knob to cancel the change.

**Note:**

- If you turn on Swish or Swish+ Media-Store Mode, Aux 4 is turned off.

**For More Information on...**

- performing a Media transition, refer to the section “Media Transitions” on page 3-3.

## File Formats

Images must be 24-bit or 32-bit (24-bit image plus 8-bit embedded alpha channel) Targa files.

Animations must be Targa sequences, a collection of individual image files (one file per animation frame).

## Animation Naming Convention

The individual files share a common name with a sequential frame number appended at the end as follows:

- Anim\_001.tga
- Anim\_002.tga
- Anim\_003.tga
- ...
- Anim\_100.tga

These files are treated as a 100 frame animation named *Anim*.

**Note:**

- Files must be numbered sequentially.
- File numbers must be preceded by an underscore “\_” character to be recognized as part of an animation.
- All files in an animation must be stored in the same directory.

### Auto Select Video and Alpha Pairing

The switcher supports images and animations with an embedded alpha-channel. The switcher uses the following Media-Store alpha-channel pairings by default:

**Table 6.1 Media-Store Alpha Channels**

Media-Store Channel	Associated Alpha Media-Store Channel
<b>Tall Mode</b>	
Media 1	Media 2
<b>Dual Mode<sup>a</sup></b>	
Media 1	Media 3
Media 2	Media 4

a. Associated Media-Store alpha channels can not be changed in this Media-Store mode.



**For More Information on...**





- Associating alpha channel inputs with video inputs, refer to the section “Input BNC Configuration” on page 2-6.

### Loading Media by Browsing

You can browse the file system on the switcher or a USB drive to select images and animations to load.

**To load an image or animation by browsing the file system:**

1. If you are loading from a USB drive, insert it into the USB port on the switcher. Wait 5 seconds after inserting the USB drive before using it.
2. Select the source button for the media-store channel (**MEDIA**) that you want to load a still or animation into. The image that is currently loaded into that channel is shown on the menu.
3. Press the  **Browse** knob.
4. Use the  left knob to select **<.>** to move up to the top level of the file system.

5. Use the  left knob to select the location you wish to browse. You can choose from the following:
  - **INT (0)** — Internal storage
  - **USB (1)** — USB drive
6. Use the  left knob to browse the file system. Turning the knob cycles through all the files and directory names at the current level in the file system.
7. Navigate to sub-directories by selecting a sub-directory name and then pressing the left knob. Sub-directories are displayed as follows:
  - **<directory-name>**
8. Return to a parent directory by selecting **<.>**.
9. Use the  left knob to select the still or animation file you want to load.
10. Press the  left knob to load the image into the selected Media-Store channel.

**Note:**

- Turn the middle knob when browsing the file system to display the full text of long directory lists and filenames.
- If you select an animation, the number of frames is displayed next to the filename.
- A number of default stills are provided in the **samples/** directory on the internal media storage of the switcher. You must select the folder under samples for the video format the switcher is operating in.

**For More Information on...**

- accessing the USB port, refer to the section “Frame Overview” on page 1-3.

### Loading Media by FTP

You can upload images and animations to your switcher from a computer using an FTP connection.

**To upload an image over an FTP connection:**

1. Create an FTP connection from a computer to your switcher using the following user account:
  - name: **xpression**
  - password: **password**
2. Copy images or animations to the folder corresponding to the Media-Store channel you wish to load images or animations to. The folder

names and the corresponding Media-Store channels are:

- **1** — Media-Store channel 1.
- **2** — Media-Store channel 2.
- **3** — Media-Store channel 3.
- **4** — Media-Store channel 4.

3. Close the FTP connection.

**Note:**

- Media-Store channels 3 and 4 are for alpha channels only. Images or animations stored in those channels are not accessible from the switcher control panel.
- If you load an image or animation with an embedded alpha channel, the switcher automatically places the alpha channel in the paired Media-Store channel.

**For More Information on...**

- creating an FTP connection, refer to the section “Creating an FTP Connection” on page 4-6.
- pairing Media-Store channels, refer to the section “Input BNC Configuration” on page 2-6.

## Understanding Media Numbers

Each image and animation is uniquely identified by a Media number. Media numbers are 4 digits and take the format shown in Figure 6.1.

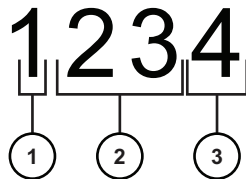

**Figure 6.1** Media Number

1. **Place** — This digit represents the location where image or animation is stored.
  - **0** — Internal Memory
  - **1** — USB drive
2. **Bank** — This digit represents the bank number. There are 100 (0 - 99) banks where images can be stored.
3. **Item Number** — This digit represents the item number. Each bank contains 10 (0 - 9) images.

## Entering Media Numbers

Media numbers are entered using the Wipe Pattern buttons. You can choose to lock the Place and Bank to specific values which allows you to quickly access a subset of images.

### To lock or unlock place and bank values:

1. Select the source button for the media-store channel (**MEDIA**) that you want to load a still or animation into. The image that is currently loaded into that channel is shown on the menu.
2. Press the **Browse** knob.
3. Press **NEXT**.
4. Press the **Place** knob to lock or unlock the Place value. When locked, the Place value will be surrounded by brackets [].
5. If you locked the Place value, use the **Place** knob to select the locked value. You can choose from the following:
  - **INT-0** — Internal storage
  - **USB-1** — USB drive (default)
6. Press the **Media** knob to lock or unlock the Bank value. When locked, the Bank value is enclosed in brackets [].
7. If you locked the Bank value, use the **Bank** knob to select the locked value.

## Loading Media by Media Number

Once an image has been assigned a Media number, it can be quickly reloaded by typing the corresponding Media number using the Wipe Pattern buttons. The procedure is slightly different if you have locked the Place and Bank values.

### To load an image by Media number with a locked place and bank number:

1. If you are loading from a USB drive, insert it into the USB port on the switcher. Wait 5 seconds after inserting the USB drive before using it.
2. Select the source button for the media-store channel (**MEDIA**) that you want to load a still or animation into. The image that is currently loaded into that channel is shown on the menu.
3. Press the Wipe Pattern button corresponding to the item number (in the locked Place and Bank) of the image you wish to load.

**Note:**

- If the image you are loading is not present on the drive, a Media Error message is displayed. You

have the option to free up the media location (**Free**) or not.

- Entering a Media number of **0** clears the image from the selected Media-Store channel.
- When you load an animation to an off-air media-store channel, or the animation goes off-air with a transition, the preview shows the cut point (**CutTM**) for that animation, and not the first frame of the video.

#### For More Information on...

- accessing the USB port, refer to the section “Frame Overview” on page 1-3.

#### To load an image by Media number without a locked place or bank number:

1. If you are loading from a USB drive, insert it into the USB port on the switcher. Wait 5 seconds after inserting the USB drive before using it.
2. Select the source button for the media-store channel (**MEDIA**) that you want to load a still or animation into. The image that is currently loaded into that channel is shown on the menu.
3. Use the Wipe Pattern buttons to type the Media number corresponding to the image you wish to load. Type only the unlocked portion of the Media number (if the Place value is locked, do not type a Place value).
4. Press the  **Select** knob to load the image.

#### Note:

- Entering a Media number of **000** clears the image from the selected Media-Store channel.
- If the image you are loading is not present on the drive, a Media Error message is displayed. You have the option to free up the media location (**Free**) or not.
- When you load an animation to an off-air media-store channel, or the animation goes off-air with a transition, the preview shows the cut point (**CutTM**) for that animation, and not the first frame of the video.

#### For More Information on...

- accessing the USB port, refer to the section “Frame Overview” on page 1-3.











## Media-Store Attributes

Media-Store attributes can be broken down into three types; Still Attributes, Animation Attributes, and Media Transition Attributes.

## Still Attributes

You can alter the appearance of a Media-Store still images by modifying display parameters.

#### To set the attributes of at still image:

1. Select the source button for the media-store channel (**MEDIA**) that you want to load a still or animation into. The image that is currently loaded into that channel is shown on the menu.
2. Press  **NEXT** until **Attrib** is displayed.
3. Adjust the position of the image as follows:
  - Use the  **Attrib** knob to select **X-Pos**.
  - Use the  **Value** knob to select the X position of the image.
  - Use the  **Attrib** knob to select **Y-Pos**.
  - Use the  **Value** knob to select the Y position of the image.
4. Select whether the still should be a shaped or unshaped key by default as follows:
  - Use the  **Attrib** knob to select **Shaped**.
  - Use the  **Value** knob to select whether the images is shaped or unshaped.
    - › **Yes** — Image is shaped.
    - › **No** — Image is unshaped.
5. Set the media number for the still image as follows:
  - Use the  **Attrib** knob to select **Media#**.
  - Use the  **Value** knob to select a new Media number. Only available Media numbers are displayed.
6. Use the  **Func** knob to select **SavAll**.
7. Press the  **Func** knob to save your settings.

#### Note:

- You can use the positioner to modify the X and Y position (CrossOver 12 only).

#### For More Information on...

- shaped and unshaped keys, refer to the section “Input BNC Configuration” on page 2-6.











## Animation Attributes

You can alter the appearance of a Media-Store animations by modifying display and play parameters.



Media-Store animation have the same attributes as stills with the addition of looping, reverse, auto play, and speed.

#### To modify animation playback:









1. Select the source button for the media-store channel (**MEDIA**) that you want to load a still or animation into. The image that is currently loaded into that channel is shown on the menu.
2. Press  **NEXT** until **Attrib** is displayed.
3. Set the looping behavior as follows:
  - Use the  **Attrib** knob to select **Looping**.
  - Use the  **Value** knob to set the looping behavior.
    - › **yes** — The animation plays in a continuous loop until manually stopped.
    - › **no** — The animation plays once.
4. Set the playback direction as follows:
  - Use the  **Attrib** knob to select **Reverse**.
  - Use the  **Value** knob to set the reverse playback behavior.
    - › **yes** — The animation plays backwards.
    - › **no** — The animation plays forwards.
5. Set the auto playback behavior as follows:
  - Use the  **Attrib** knob to select **AutoPly**.
  - Use the  **Value** knob to set the auto playback behavior.
    - › **yes** — The animation starts playing automatically when it is taken on-air.
    - › **no** — Animation playback must be started manually.
6. Set the playback speed as follows:
  - Use the  **Attrib** knob to select **Speed**.
  - Use the  **Value** knob to set the playback speed.
    - › **0.1x – 1.0x** in 0.1x increments.
    - › **1x – 10x** in 1x increments.
7. Use the  **Func** knob to select **SavAll**.
8. Press the  **Func** knob to save your settings.

#### Media Transition Attributes

You can alter the appearance of a media transitions by modifying display, play, and transition parameters.

Media transitions have the same attributes as animations with the addition of cut point, and GPI output triggers.



#### To modify media transition parameters:

1. Select the source button for the media-store channel (**MEDIA**) that you want to load a still or animation into. The image that is currently loaded into that channel is shown on the menu.
  2. Press  **NEXT** until **Attrib** is displayed.
  3. Set the cut point as follows:
    - Use the  **Attrib** knob to select **CutTm**.
    - Use the  **Value** knob to set the length of time, in frames, from the beginning of the animation before the switcher performs the cut. This should be the point in the media-store animation that the image is full-screen.
  4. Assign a GPI output to the media transition as follows:
    - Use the  **Attrib** knob to select **GPO**.
    - Use the  **Value** knob to select the GPI output that you want to trigger by the media transition.
  5. Assign a trigger time to the selected GPI output as follows:
    - Use the  **Attrib** knob to select **GPOTm**.
    - Use the  **Value** knob to select the length of time, in frames, before or after the start of the animation the GPI output is triggered. If you select a negative value, the switcher will trigger the GPI output and wait for the specified time before starting the animation (similar to a pre-roll value).
  6. Use the  **Func** knob to select **SavAll**.
  7. Press the  **Func** knob to save your settings.
- Note:**
- You can also set the cut point by using the fader to run through the animation to the desired cut point, and then press and hold **MEDIA** and press **CUT**.



#### Animation Control

You can play an animation manually or automatically and also control the behavior of animation playback.

### To manually play an animation:

1. Select the source button for the media-store channel (**MEDIA**) that you want to load a still or animation into. The image that is currently loaded into that channel is shown on the menu.
2. Press the  **Run** knob to start the animation playing.
3. Press the  **Stop** knob to stop the animation before reaching the final frame.

#### Note:

- When you load an animation to an off-air media-store channel, or the animation goes off-air with a transition, the preview shows the cut point (**CutTM**) for that animation, and not the first frame of the video.
- You can manually cycle through frames by turning the  **Run** knob while the animation is stopped.
- Double-pressing the  **Run** knob stops playback and re-cues the animation to the first frame.

3. Use the  **Func** knob to save the attributes for that image. You can choose from the following:
  - **Revert** — Reverts the currently displayed attribute to the previously saved value. Other attributes are not affected.
  - **RevAll** — Reverts all attributes to previously saved values.

## Saving and Reverting Attributes

You can save attributes for an image so they are automatically recalled the next time that image is loaded from a USB drive or internal memory.

Image attributes that have been changed since they were last saved are marked with a ‘\*’.

### To save attributes for an image:

1. Modify the attributes for an image as necessary
2. Use the  **Func** knob to save the attributes for that image. You can choose from the following:
  - **Save** — Saves the currently displayed attribute. Other saved attributes are not affected.
  - **SavAll** — Saves all attributes.

### To revert to saved attribute values:

1. Select the source button for the media-store channel (**MEDIA**) that you want to load a still or animation into. The image that is currently loaded into that channel is shown on the menu.
2. Press  **NEXT** until **Attrib** is displayed.



# Calibration and Diagnostics

This chapter describes how to check the version of software on the switcher, copy switcher logs to a USB, perform calibration and systems tests, as well as what the error messages reported by the switcher mean.

## Switcher Software Version

The Status menu shows the version number of the software that is currently running on the control panel and frame.







**To view the current version of software on the switcher:**

1. Press  **MENU**.
2. Press the  **STATUS** Wipe Pattern button. The current software version (**SW Ver**) and reference format is shown on the menu.

## Copy Logs to USB

The Copy Logs allows you to store switcher logs onto a USB. Switcher logs can be used by technical support to diagnose problems with your switcher.









**To copy switcher logs to USB:**

1. Insert it into the USB port on the switcher. Wait 5 seconds after inserting the USB drive before using it.
2. Press  **MENU** >  **SYSTEM** >   
**NEXT** >  **NEXT**.
3. Press the  **Diag Tests** knob.
4. Press  **NEXT**.
5. Press the  **Copy Logs** knob. The logs are copied to the root directory of the USB.

## Calibration

Calibration allows you to reset the limits of the faders on the control panel and re-center the positioner with X and Y limits.

**To calibrate the positioner and fader:**

1. Press  **MENU** >  **SYSTEM** >   
**NEXT** >  **NEXT**.
2. Press the  **Diag Tests** knob.
3. Press  **NEXT**.
4. Press the  **Calib Reset** knob.
5. Move the positioner backwards and forwards and left to right a few times.
6. Move the fader from one limit to the next a few times. Do not push the fader hard when it reaches the limit.
7. Press  **MENU** to save the calibration information.









## Diagnostics

Diagnostics consist of a number of tests that are used to test the functionality of a number of switcher functions.

### Control Test

The Control Test allows you to test the functionality of any of the buttons, knobs or fader and positioner on the control panel.







**To test control panel control surfaces:**

1. Press  **MENU** >  **SYSTEM** >   
**NEXT** >  **NEXT**.
2. Press the  **Diag Tests** knob.
3. Press the  **Contrl Test** knob. The second line of the display show the current button, knob, positioner, or fader being used.
4. Test the button, knob, positioner, and fader you want to check.
5. Press the  **MENU** and  **RESET** buttons at the same time to end the test.

## Panel LED Test

The Panel LED Test turns on all buttons and indicators on the control panel and cycles through a series of colors.







### To test the control panel LEDs:

1. Press  **MENU** >  **SYSTEM** >  **NEXT** >  **NEXT**.
2. Press the  **Diag Tests** knob.
3. Press the  **P-Leds Test** knob. All the buttons and indicators on the control panel cycle through different colors.
4. Press  **MENU** to end the test.

## Display Test

The Display Test runs a series of letters, numbers, and symbols across the menu display.









### To test the control panel LEDs:

1. Press  **MENU** >  **SYSTEM** >  **NEXT** >  **NEXT**.
2. Press the  **Diag Tests** knob.
3. Press the  **Display Test** knob. A series of letters, numbers, and symbols scroll across the display.
4. Press  **MENU** to end the test.

## RAM Test

The RAM Test performs a test of the system memory in the switcher. To test the RAM of the switcher, a full reboot must be performed.

### To test the switcher RAM:

1. Press  **MENU** >  **SYSTEM** >  **NEXT** >  **NEXT**.
2. Press the  **Diag Tests** knob.
3. Press  **NEXT**.
4. Press the  **RAM Test** knob. The top line of the menu shows the result of the last RAM test.
5. Press the  **Reboot** knob to run the test. The switcher runs the test and then reboots.









6. The results of the test are shown on the top line of the menu.

7. Press  **MENU** to end the test.

## Tally Test

The Tally Test turns all tallies off, and then turns each tally on consecutively. There is a three (3) second delay between each tally being toggled on. Once the last tally has been turned on, all the tallies blink on and off three times.









### To test switcher tallies:

1. Press  **MENU** >  **SYSTEM** >  **NEXT** >  **NEXT**.
2. Press the  **Diag Tests** knob.
3. Press  **NEXT** >  **NEXT**.
4. Press the  **Tally Test** knob to start the test.
5. Press  **MENU** to end the test.

## GPI Test

The GPI input test reports the state of each GPI input on the menu.









### To test GPI Inputs:

1. Press  **MENU** >  **SYSTEM** >  **NEXT** >  **NEXT**.
2. Press the  **Diag Tests** knob.
3. Press  **NEXT** >  **NEXT**.
4. Press the  **GPI Test** knob to start the test. The second line of the menu show the state of all GPI input pins as High or Low.
5. Press  **MENU** to end the test.

## GPO Test

The GPO test turns all GPI outputs off, and then fires each one consecutively. There is a three (3) second delay between each GPI output being fired. Once the last tally has been fired, all the GPI outputs blink on and off three times.

### To test GPI Outputs:

1. Press  **MENU** >  **SYSTEM** >  **NEXT** >  **NEXT**.
2. Press the  **Diag Tests** knob.
3. Press  **NEXT** >  **NEXT**.
4. Press the  **GPO Test** knob to start the test.
5. Press  **MENU** to end the test.

## Error Messages

The following error messages may appear when starting your switcher.

**Table 7.1 Switcher Error Messages**

Error Message	Description	Solution
DDR 0 Not Found DDR 1 Not Found DDR 0 & 1 Not Found	There is a problem with the switcher DDR memory. The switcher may be used but many features will be limited or disabled	Re-start your switcher. If the problem persists, contact Ross Video Technical Support for assistance.
Panel/Frame Mismatch	Your switcher control panel is connected to the wrong frame type (e.g. Crossover 12 panel connected to a Crossover 6 frame).	Connect your switcher control panel to the proper frame and re-start the switcher.
Upgrade PMC?	Your switcher requires a Panel Module Controller (PMC) upgrade as part of a software upgrade. The switcher may be used without the PMC upgrade but may respond in an unpredictable manner	Allow the PMC upgrade to proceed. Contact Ross Video Technical Support for assistance if you are unsure about upgrading your switcher.



# Specifications

## Dimensions

Frame:

- Width: 19" (48.25cm) (fits standard equipment rack)
- Depth: 15.63" (39.70cm)
- Height: 3.5" (8.89cm) (2RU)

Control Panel:

- Width: 15.85" (40.26cm)
- Depth: 10.64" (27.03cm)
- Height: 3.5" (8.89cm)

## Weight:

Frame:

- 16.4 lbs (7.44kg)

Control Panel:

- CrossOver 6: 7.2 lbs (3.27kg)
- CrossOver 12: 7.4 lbs (3.36kg)

## Power Requirements

- Frame: DC 12V, 6 Amps Max
- Control Panel: DC 12V, 4 Amps Max

## Ports

### Tally Port

- Load voltage: 100Vdc max
- Load current: 120mA max at 85C, 150mA at 25C.
- On resistance: 8 mΩ max

### GPI I/O Absolute Maximum Ratings

- Input voltage range: -0.5V to 5.5V
- Output current: < ±10mA

### Editor Port DC Operating Conditions

- Maximum differential input voltage: ±5V
- Differential output voltage (5V circuit): 3.2V  
Typical across a 100 Ω load (2.3V for 3.3V circuit)

## Ethernet Port

- 10/100Mbps Ethernet using Cat 5 cables  
10BASE-T & 100BASE-Tx

## USB Port

- USB 2.0 and 1.1 compliant

## Video Formats

### Standard Definition Version

- 480i (4:3 and 16:9) at 59.94 Hz (Default)
- 576i (4:3 and 16:9) at 50Hz

### Multi Definition Version

- 480i (4:3 and 16:9) at 59.94 Hz
- 576i (4:3 and 16:9) at 50Hz
- 720p at 50, 59.94Hz
- 1080i at 50, 59.94Hz (Default)

## Inputs/Outputs

### Inputs

- 6 or 12 inputs (depending on version)
- Internal Black and Matte Generators

### Outputs

- 2 Program out HD-SDI
- 1 Preview out HD-SDI
- Aux 1 out HD-SDI
- Aux 2 out HD-SDI
- Aux 3 out HD-SDI

### HD-SDI Input and Output Specifications

- SMPTE 292M/259M compliant
- Levels: 800mV (±10%) peak-to-peak
- Return loss: > -15dB to 1.485GHz
- Input Equalization (SD): 275m
- Input Equalization (HD): 110m

## Reference Input and Output Specifications

### Tri-level Pulse

- Input Return Loss:  $\geq 30\text{dB}$  to 30 MHz
- Output Return Loss:  $\geq 23\text{dB}$  to 30 MHz
- Positive Peak:  $+300\text{mV} \pm 6\text{mV}$
- Negative Peak:  $-300\text{mV} \pm 6\text{mV}$
- Rise Times (10-90%):  $54\text{ns} \pm 20\text{ns}$
- Duration:  $593\text{ns} \pm 40\text{ns}$

### Bi-level Pulse

- Return Loss:  $\geq 30\text{dB}$  to 6 MHz
- Levels: NTSC:  $286\text{mV} \pm 14\text{mV}$  (40 IRE  $\pm 2$  IRE)  
PAL:  $307\text{mV}$  (43 IRE)
- Rise Times (10-90%): NTSC  $140\text{ns} \pm 20\text{ns}$  PAL:  $200\text{ns} \pm 20\text{ns}$
- Duration: NTSC:  $4.7\mu\text{s} \pm 0.1\mu\text{s}$  PAL:  $4.7\mu\text{s} \pm 0.2\mu\text{s}$

## GVG Editor Input Mapping

The following table lists the GVG Editor – switcher input mapping:

**Table 8.1 CrossOver 6 Input Mapping**

GVG Input	Switcher Input
0	Black
1	Input 1
2	Input 2
3	Input 3
4	Input 4
5	Invalid
6	Matte
7	Input 5
8	Input 6
9	Media 1
10	Media2
11	PgmOut (AuxOnly)
12	PrvOut (AuxOnly)
13	Clean (AuxOnly)
14	Chroma Key Alpha(AuxOnly)

**Table 8.2 CrossOver 12 Input Mapping**

7	Input 7
8	Input 8
9	Invalid
10	Matte
11	Input 9
12	Input 10
13	Input 11
14	Input 12
15	Invalid
16	Invalid
17	Media 1
18	Media 2
19	PgmOut (AuxOnly)
20	PrvOut (AuxOnly)
21	Clean (AuxOnly)
22	Chroma Key Alpha(AuxOnly)

**Table 8.2 CrossOver 12 Input Mapping**

0	Black
1	Input 1
2	Input 2
3	Input 3
4	Input 4
5	Input 5
6	Input 6



## GVG100 Protocol Supported Commands

The following tables list the Supported GVG100 commands and controls.

**Table 8.3 GVG100 Supported Commands**

Name	MLE/Keyer	Length	Byte Code	Data/Notes	
Read MLE Program Bus	MLE	2	41	—	
Read MLE Preset Bus	MLE	2	42	—	
Read Keyer Bus	Keyer	2	43/44	—	
Write MLE Program Bus	MLE	3	C1	<xpt>	An invalid xpt request returns a protocol error
Write MLE Preset Bus	MLE	3	C2	<xpt>	An invalid xpt request returns a protocol error
Write Keyer Bus	Keyer	3	C3/C4	<xpt>	An invalid xpt request returns a protocol error
Read Analog	MLE/Keyer	3	45	<control>	
Write Analog	MLE/Keyer	5	C5	<control>	<lsb>    <msb>
Read Light On/off	MLE/Keyer	3	46/47	—	
Write Light On/off	MLE/Keyer	3	C6/C7	<lamp>	
Read Wipe Pattern	MLE	2	48	—	
Write Wipe Pattern	MLE	3	C8	<wipe>	Valid wipes are 0-9, as per the Wipe Pattern button numbers. An invalid wipe number returns a protocol error.
Read Transition Mode	MLE	2	4A	—	
Write Transition Mode	MLE	3	CA	<mode>	Last 5 bits used; bit 0: key 1, 1: key 2, 3: bkgd, 4: key 3, 5: key 4
Read Mle Autotrans Rate	MLE	2	4C	—	
Read Keyer Mix Rate	Keyer	2	4D	—	
Read Fade To Black Rate	MLE*	2	7D	—	*Currently MLE-specific
Write Mle Autotrans Rate	MLE	5	CC	**	
Write Keyer Mix Rate	Keyer	5	CD	**	
Write Fade To Black Rate	—*	5	FD	**	*Currently not supported. Fade to black = transition rate.
Read Key Settings	Keyer	2	53	Not yet implemented	
Write Key Settings	Keyer	62(?)	D3	Not yet implemented	
Learn Into Mem	—	3	DA	<mem#>	Supports memories 0-9
Recall From Mem	—	3	DB	<mem#>	Supports memories 0-9
Read Software Version	—	2	6C	—	
Read Field Mode	—	2	6D	—	Field Mark only
Write Field Mode	—	2	ED	0 or 1	Field Mark only

**Table 8.3 GVG100 Supported Commands**

Name	MLE/Keyer	Length	Byte Code	Data/Notes
All Stop	—	3	F2	D0* *Data byte is unused
Read Lamp Status	—	3	78	0
Write Lamp Status	—	3	F8	— Included for GVG100 spec completeness only.
Write Button Press	Both	3	FB	<button>
Send Mem To Editor	—	3	7E	Not yet implemented
Load Mem From Editor	—	73	FE	Not yet implemented

**\*\*Data byte 1:**

Bit 7: 0=select elements, 1=select elements and perform transition

Bit 4-6: 4=select key 1, 5=select key 2, 6=select bkgd

Bit 0-3: binary coded decimal (valid range is b0-b1001, or 0-9)

**Data byte 2:**

Bit 6-7: Ignored

Bit 4-5: 4=select key 3, 5=select key 4

Bit 0-3: binary coded decimal (valid range is b0-b1001, or 0-9)

**Data byte 3:**

Bit 4-7: Ignored

Bit 0-3: binary coded decimal (valid range is b0-b1001, or 0-9)

**Table 8.4 GVG100 Supported Analog Controls**

Name	MLE/Keyer	Byte Code	Notes
Key Clip	Keyer	0x0A	
Key Gain	Keyer	0x0B	
Vert. Position	MLE	0x11	
Horz. Position	MLE	0x12	
Key Matte Fill Hue	MLE	0x14	Key mattes not supported
Pattern Size	MLE	0x15	
Chroma Key Hue	Keyer	0x17	Write not supported
Key Matte Border Hue	Keyer	0x18	Key mattes not supported
Key Matte Border Sat	Keyer	0x19	Key mattes not supported
Key Matte Border Lum	Keyer	0x1A	Key mattes not supported
Key Matte Fill Lum	Keyer	0x1B	Key mattes not supported
Aspect	MLE	0x1C	Aux MLEs not supported
Border Softness	MLE	0x1D	Aux MLEs not supported
Border Width	MLE	0x1E	Aux MLEs not supported
Key Matte Fill Sat	Keyer	0x1F	Key Mattes not supported
Rotate X	—	0x20	Not supported
Rotate Y	—	0x21	Not supported
Rotate Z	—	0x22	Not supported
3D Position X	—	0x23	Not supported

**Table 8.4 GVG100 Supported Analog Controls**

Name	MLE/Keyer	Byte Code	Notes
3D Position Y	—	0x24	Not supported
3D Position Z	—	0x25	Not supported
3D Border Softness	—	0x26	Not supported
3D Border Width	—	0x27	Not supported
Key Clip	Keyer	0x08	DSKs
Key Gain	Keyer	0x09	DSKs

**Table 8.5 GVG100 Supported Lamps**

Name	MLE/Keyer	Byte Code	Notes
Program Bus 0-9	MLE	0x00-0x09	Turning OFF results in a protocol error.
Program Bus On Air	MLE	0x0A	Turning OFF results in a protocol error.
Autotrans	MLE	0x0B	
Key Dissolve	Keyer	0x0C	
Key Cut	Keyer	0x0D	
Wipe Trans	MLE	0x0E	
Dissolve Trans	MLE	0x0F	
Preset Bus 0-9	MLE	0x10-0x19	Turning OFF results in a protocol error.
Preset Bus On Air	MLE	0x1A	Turning OFF results in a protocol error.
Aspect On	MLE	0x1B	Always on. Turning OFF results in a protocol error.
Positioner On	MLE	0x1C	Always on. Turning OFF results in a protocol error.
Reverse Wipe	MLE	0x1D	
Dsk Preview	Keyer	0x1E	Always true. All Keyers show on Preview. Turning OFF results in a protocol error.
Fade To Black	—	0x1F	
Key Bus 0-9	Keyer	0x20-0x29	Turning OFF results in a protocol error.
Key Bus On Air	Keyer	0x2A	Turning OFF results in a protocol error.
Key Video Fill	Keyer	0x2F	Always true. Turning OFF results in a protocol error.
Wipe Type	MLE	0x30-0x39	Turning OFF results in a protocol error.
Key Invert	Keyer	0x40	DSKs. Turning OFF results in a protocol error.
Key Mask	Keyer	0x41	DSKs. Turning OFF results in a protocol error.
Key Autokey	Keyer	0x42	DSKs. Turning OFF results in a protocol error.
Key Selfkey	Keyer	0x43	DSKs. Turning OFF results in a protocol error.

**Table 8.5 GVG100 Supported Lamps**

Name	MLE/Keyer	Byte Code	Notes
Key Invert	Keyer	0x44	Turning OFF results in a protocol error.
Key Mask	Keyer	0x45	Turning OFF results in a protocol error.
Memory Mode Toggle	—	0x47	Toggles between memory and pattern modes.
Next Trans Is Bkgd	—	0x48	Turning OFF results in a protocol error.
Next Trans Is Key 1	—	0x49	Turning OFF results in a protocol error.
Cut	MLE	0x4A	Turning OFF results in a protocol error.
Key Selfkey	Keyer	0x4C	Turning OFF results in a protocol error.
Key Autokey	Keyer	0x4D	Turning OFF results in a protocol error.
Key Chromakey	Keyer	0x4E	Turning OFF results in a protocol error.
Editor Enable	—	0x4F	Editor control is always enabled. Turning OFF results in a protocol error.
Keyer Active	Keyer	0x52	

**Table 8.6 GVG100 Supported Buttons**

Name	MLE/Keyer	Byte code	Notes
Program Bus 0-9	MLE	0x00-0x09	
Autotrans	MLE	0x0B	
Key Trans	Keyer	0x0C	DSKs
Key Cut	Keyer	0x0D	DSKs
Wipe Trans	MLE	0x0E	
Dissolve Trans	MLE	0x0F	
Preset Bus 0-9	MLE	0x10-0x19	
Aspect	MLE	0x1B	Always on. Button press has no effect.
Positioner On	—	0x1C	Always on. Button press has no effect.
Reverse Wipe	MLE	0x1D	Doubles as memory store/recall toggle when in memory mode
Dsk Preview	—	0x1E	Always true. All Keyers show on preview.
Fade To Black		0x1F	
Key Bus 0-9	Keyer	0x20-0x29	
Key Video Fill	Keyer	0x2F	Always true.
Wipe Type	MLE	0x30-0x39	
Key Invert	Keyer	0x40	DSKs
Key Mask	Keyer	0x41	DSKs
Key Autokey	Keyer	0x42	DSKs
Key Selfkey	Keyer	0x43	DSKs
Key Invert	Keyer	0x44	

**Table 8.6 GVG100 Supported Buttons**

<b>Name</b>	<b>MLE/Keyer</b>	<b>Byte code</b>	<b>Notes</b>
Key Mask	Keyer	0x45	
Memory Mode Toggle	—	0x47	Toggles between memory mode and pattern mode.
Next Trans Is Bkgd	—	0x48	
Next Trans Is Key 1	—	0x49	
Cut	MLE	0x4A	
Key Selfkey	Keyer	0x4C	
Key Autokey	Keyer	0x4D	
Key Chromakey	Keyer	0x4E	
Editor Enable	—	0x4F	Editor control is always enabled.

