

# XPression

## Clips Workflow User Guide

VERSION 12.6

**ROSS**



# Thank You for Choosing Ross

You've made a great choice. We expect you will be very happy with your purchase of Ross Technology.

Our mission is to:

1. Provide a Superior Customer Experience
  - offer the best product quality and support
2. Make Cool Practical Technology
  - develop great products that customers love

Ross has become well known for the Ross Video Code of Ethics. It guides our interactions and empowers our employees. I hope you enjoy reading it below.

If anything at all with your Ross experience does not live up to your expectations be sure to reach out to us at [solutions@rossvideo.com](mailto:solutions@rossvideo.com).



David Ross

CEO, Ross Video

[dross@rossvideo.com](mailto:dross@rossvideo.com)

## Ross Video Code of Ethics

Any company is the sum total of the people that make things happen. At Ross, our employees are a special group. Our employees truly care about doing a great job and delivering a high quality customer experience every day. This code of ethics hangs on the wall of all Ross Video locations to guide our behavior:

1. We will always act in our customers' best interest.
2. We will do our best to understand our customers' requirements.
3. We will not ship crap.
4. We will be great to work with.
5. We will do something extra for our customers, as an apology, when something big goes wrong and it's our fault.
6. We will keep our promises.
7. We will treat the competition with respect.
8. We will cooperate with and help other friendly companies.
9. We will go above and beyond in times of crisis. *If there's no one to authorize the required action in times of company or customer crisis - do what you know in your heart is right. (You may rent helicopters if necessary.)*

# XPression User Guide

- Ross Part Number: 3500DR-016-12.6
- Version: 12.6
- Date/Time: 3/19/2026 2:55 PM

The information contained in this guide is subject to change without notice or obligation.

## Copyright

©2026 Ross Video Limited, Ross®, and any related marks are trademarks or registered trademarks of Ross Video Limited. All other trademarks are the property of their respective companies. PATENTS ISSUED and PENDING. All rights reserved. No part of this publication may be reproduced, stored in a retrieval system, or transmitted in any form or by any means, mechanical, photocopying, recording or otherwise, without the prior written permission of Ross Video. While every precaution has been taken in the preparation of this document, Ross Video assumes no responsibility for errors or omissions. Neither is any liability assumed for damages resulting from the use of the information contained herein.

## Patents

Patent numbers US 7,034,886; US 7,508,455; US 7,602,446; US 7,802,802 B2; US 7,834,886; US 7,914,332; US 8,307,284; US 8,407,374 B2; US 8,499,019 B2; US 8,519,949 B2; US 8,743,292 B2; GB 2,419,119 B; GB 2,447,380 B; and other patents pending.

## Notice

The material in this manual is furnished for informational use only. It is subject to change without notice and should not be construed as commitment by Ross Video Limited. Ross Video Limited assumes no responsibility or liability for errors or inaccuracies that may appear in this manual.

# End User Software License Agreement

This End User Software License Agreement is a legal agreement between you (the "Licensee") and Ross Video Limited ("Ross Video") specifying the terms and conditions of your installation and use of the Software and all Documentation (as those terms are defined herein).

## IMPORTANT:

**BY DOWNLOADING, ACCESSING, INSTALLING OR USING THE SOFTWARE AND/OR DOCUMENTATION AND/OR BY AUTHORIZING ANY THIRD PARTY, INCLUDING WITHOUT LIMITATION AN INSTALLER OR COMMISSIONER ACTING ON YOUR BEHALF TO DO SO, LICENSEE AGREES TO THE TERMS OF THIS AGREEMENT AND THE LICENSE GRANTED HEREUNDER SHALL BE EFFECTIVE AS OF AND FROM SUCH DATE. IF YOU DO NOT WISH TO ACCEPT THE TERMS AND CONDITIONS OF THIS AGREEMENT, DO NOT DOWNLOAD, ACCESS, INSTALL, REFER TO OR OTHERWISE USE THE SOFTWARE AND/OR DOCUMENTATION.**

1. **INTERPRETATION.** In this Agreement, (a) words signifying the singular number include the plural and vice versa, and words signifying gender include all genders; (b) every use of the words "herein", "hereof", "hereto" "hereunder" and similar words shall be construed to refer to this Agreement in its entirety and not to any particular provision hereof; (c) reference to any agreement or other document herein will be construed as referring to such agreement or other document as from time to time amended, modified or supplemented (subject to any restrictions on such amendment, modification or supplement set forth therein); (d) every use of the words "including" or "includes" is to be construed as meaning "including, without limitation" or "includes, without limitation", respectively; and (e) references to an Article or a Section are to be construed as references to an Article or Section of or to this Agreement unless otherwise specified.
2. **DEFINITIONS.** In this Agreement, in addition to the terms defined elsewhere in this Agreement, the following terms have the meanings set out below:

"**Affiliate**" means, with respect to any Person, any other Person who directly or indirectly controls, is controlled by, or is under direct or indirect common control with, such Person. A Person shall be deemed to control a Person if such Person possesses, directly or indirectly, the power to direct or cause the direction of the management and policies of such Person, whether through the ownership of voting securities, by contract or otherwise; and the term "controlled" and "controlling" shall have a similar meaning.

"**Agreement**" means this End User Software License Agreement including the recitals hereto, as the same may be amended from time to time in accordance with the provisions hereof.

"**Backup System**" means the secondary piece of Designated Equipment upon which the Software is installed and mirrored for the sole purpose of replacing a Primary System in the event such Primary System is not available or functioning properly for any reason.

"**Change of Control**" means (a) the direct or indirect sale, transfer or exchange by the shareholders of a Party of more than fifty percent (50%) of the voting securities of such Party, (b) a merger or amalgamation or reorganization or other transaction to which a Party is party after which the shareholders of such Party immediately prior to such transaction hold less than fifty percent (50%) of the voting securities of the surviving entity, (c) the sale, exchange, or transfer of all or substantially all of the assets of a Party.

**"Confidential Information"** means all data and information relating to the business and management of either Party, including the Software, trade secrets and other technology to which access is obtained or granted hereunder by the other Party, and any materials provided by Ross Video to Licensee; provided, however, that Confidential Information shall not include any data or information which:

- (i) is or becomes publicly available through no fault of the other Party;
- (ii) is already in the rightful possession of the other Party prior to its receipt from the other Party;
- (iii) is already known to the receiving Party at the time of its disclosure to the receiving Party by the disclosing Party and is not the subject of an obligation of confidence of any kind;
- (iv) is independently developed by the other Party;
- (v) is rightfully obtained by the other Party from a third party; or
- (vi) is disclosed with the written consent of the Party whose information it is.

**"Designated Equipment"** shall mean (a) the hardware products sold by Ross Video to Licensee on which the Software is installed and licensed for use, as the same may be replaced from time to time by Ross Video; or (b) in the case of Software licensed on a stand-alone basis, the equipment of Licensee on which the Software is to be installed and meets the minimum specifications set out in the Documentation.

**"Documentation"** shall mean manuals, instruction guides, user documentation and other related materials of any kind pertaining to the Software (whether in electronic, hard-copy or other media format) that are furnished to Licensee by or on behalf of Ross Video in relation to the Software.

**"Freeware"** means Software that is available free of charge from Ross Video, and includes, without limitation the master control system software known as "DashBoard".

**"Governmental Authority"** means (a) any federal, provincial, state, local, municipal, regional, territorial, aboriginal, or other government, governmental or public department, branch, ministry, or court, domestic or foreign, including any district, agency, commission, board, arbitration panel or authority and any subdivision of any of them exercising or entitled to exercise any administrative, executive, judicial, ministerial, prerogative, legislative, regulatory, or taxing authority or power of any nature; and (b) any quasi-governmental or private body exercising any regulatory, expropriation or taxing authority under or for the account of any of them, and any subdivision of any of them.

**"Improvements"** means all inventions, works, discoveries, improvements and innovations of or in connection with the Software, including error corrections, bug fixes, patches and other updates in Object Code form to the extent made available to Licensee in accordance with Ross Video's release schedule.

**"License Fee"** means the fee(s), if any, payable in respect of the Software in accordance with the relevant invoice(s) or other purchase documents delivered in connection with this Agreement.

**"License Period"** means the period of time that Licensee will have the rights granted under this Agreement, as may be specified in an Order.

**"Modifications"** means any enhancements, changes, corrections, translations, adaptations, revisions, developments, upgrades or updates thereto; and "Modify" shall mean the creation of any of the foregoing.

**"Object Code"** means the machine readable executable form of a computer software program.

**"Open Source Components"** means third party Open Source software, libraries or other components.

**"Open Source License"** means the license that governs each Open Source Component.

**"Order"** means the documents provided by Ross Video to Licensee detailing the Ross Video products contemplated for purchase, the corresponding fees and License Period that may apply to the Software, including any and all quotations, purchase orders, acknowledgments, pro formas, invoices and other purchase documentation.

**"Parties"** means both Ross Video and Licensee and "Party" means either one of them as the context requires.

**"Person"** will be broadly interpreted and includes (a) a natural person, whether acting in his or her own capacity, or in his or her capacity as executor, administrator, estate trustee, trustee or personal or legal representative; (b) a corporation or a company of any kind, a partnership of any kind, a sole proprietorship, a trust, a joint venture, an association, an unincorporated association, an unincorporated syndicate, an unincorporated organization or any other association, organization or entity of any kind; and (c) a Governmental Authority.

**"Primary System"** means the Designated Equipment upon which the Software is installed and executed to deliver its intended functionality.

**"Released Claims"** has the meaning ascribed to it in Section 9(b).

**"Released Parties"** has the meaning ascribed to it in Section 9(b).

**"Ross Video"** means Ross Video Limited and its Affiliates.

**"Software"** means the version of the Object Code licensed and delivered to Licensee by Ross Video concurrently with delivery of this Agreement, including without limitation the Freeware, and any subsequent error corrections, updates, Modifications or Improvements provided to Licensee by Ross Video pursuant to this Agreement, but specifically excluding any features or plug-ins that may be purchased by you directly from third parties as upgrades or enhancements to the Software.

**"Source Code"** means the human readable form of a computer software program, and all tools and documentation necessary for a reasonably competent computer programmer to understand, maintain and Modify the Software.

**"Third Party Software"** means those portions of the Software, if any, which are owned or controlled by third parties and licensed to Ross Video pursuant to certain license agreements or arrangements with such third parties, including the Open Source Components and NDI®<sup>1</sup> software (<http://NDI.video>); and

**"Use"** means to execute, run, display, store, merge, network, Modify, translate, host or integrate with Licensee's products or other third party software.

<sup>1</sup> NDI® is a registered trademark of Vizrt NDI AB.

3. **LICENSE.** Subject to the terms and conditions of this Agreement, upon payment of the applicable License Fee by Licensee, or, in the case of Freeware only, upon download of the Software by Licensee onto its Designated Equipment, Ross Video hereby grants to Licensee a non-transferable and non-exclusive right to Use the Software and Documentation solely for the internal use of Licensee (the "License"), during the License Period. In the event that a License Period is not identified on the Order, such License Period shall be deemed to be perpetual, subject to paragraph 10 (c) of this Agreement. The Software shall only be used in connection with or installed on the Designated Equipment and, where applicable, shall only be used on the Primary System, provided such Primary System is operating properly."

If the Primary System is not operating properly for any reason, the Software may be used on the designated Backup System for that Primary System until such time that the Primary System begins operating properly. The Software and Documentation are provided to Licensee for the exclusive use by Licensee's organization for its ordinary business purposes and shall not be used by any third party for any purposes. Licensee may make copies of the Software as required for internal backup and archival purposes. To the extent permitted hereunder, Licensee may distribute copies of the Software and/or Documentation to members of its organization, provided (a) this Agreement is included with each copy, (b) any member of its organization who uses the Software and/or Documentation accepts and agrees to be bound by the terms of this Agreement and by any other license agreements or other agreement incorporated by reference into this Agreement, and (c) Licensee has paid any applicable additional License Fees in respect of copying and redistributing of the Software. To the extent Licensee is permitted to make copies of the Software under this Agreement, Licensee agrees to reproduce and include on any copy made or portion merged into another work, all Ross Video proprietary notices, including any notices with respect to copyrights, trademarks and this License. With the exception of copying the Software for backup or archival purposes, Licensee agrees to keep a record of the number and location of all such copies and will make such record available at Ross Video's request. The Software may include mechanisms to limit or inhibit copying.

4. **LICENSE RESTRICTIONS.** Except as otherwise provided in section 3 above, Licensee shall not: (1) copy any Software or Documentation, or part thereof, which is provided to Licensee by Ross Video pursuant to this Agreement, in Object Code form, Source Code form or other human or machine readable form, including written or printed documents, without the prior written consent of Ross Video; (2) in any way market, distribute, export, translate, transmit, merge, Modify, transfer, adapt, loan, rent, lease, assign, share, sub-license, sell, make available for download on any website or make available to another Person, the Software and/or Documentation, in whole or in part, provided that Licensee shall not be prohibited from renting or leasing the Software if Ross Video has consented, in writing, to Licensee engaging in such activities in respect of the Software; (3) reverse engineer, decompile or disassemble the Software or electronically transfer it into another computer language; or (4) use the Software or Documentation in a manner that is inconsistent with the License granted hereunder or that will result in a breach of this Agreement. Licensee agrees to take all reasonable precautions to prevent third parties from using the Software and/or Documentation in any way that would constitute a breach of this Agreement, including such precautions Licensee would ordinarily take to protect its own proprietary software, hardware or information.
5. **DELIVERY.** Ross Video shall deliver to Licensee one (1) master copy of the Software in compiled binary (executable) form suitable for reproduction in electronic files only and Ross Video shall deliver to Licensee a minimum of one copy of the Documentation.
6. **IMPROVEMENTS.** Licensee may from time to time request Ross Video to incorporate certain Improvements into the Software. Ross Video may, in its sole discretion, undertake to incorporate and provide such Improvements to Licensee with or without payment of a fee to be negotiated at the time of such request. All Improvements, whether recommended and developed by Ross Video or Licensee, shall be considered the sole property of Ross Video and shall be used by Licensee pursuant to the terms of the License granted under this Agreement.

7. **FREWARE.** Other than the obligation to pay a License Fee, which does not apply to the Freeware, all other provisions of this End User Software License Agreement apply to the Freeware in the same way as they apply to all other Software that is the subject of this Agreement. In addition, in connection with the Freeware, the following provisions apply:
  - a. Licensee will not Use the Freeware to engage in or allow others to engage in any illegal activity.
  - b. Licensee will not Use the Freeware in any way that will interfere with or damage the operation of the services of any third parties by overburdening/disabling network resources through automated queries, excessive usage or similar conduct.
  - c. Licensee will not Use the Freeware to engage in any activity that will violate the rights of others, including, without limitation, by using it for operations that involve child labour, suppressing the right of freedom of expression or endangering the security of person.
8. **OWNERSHIP.** The Parties acknowledge and agree that, as between the Parties, Ross Video shall be the owner of all intellectual property rights in the Software, Documentation and all related Modifications and Improvements, written materials, logos, trademarks, trade names, copyright, patents, trade secrets and moral rights, registered or unregistered. No proprietary interest or title in or to the intellectual property in the Software, Documentation or any Improvements or Modifications is transferred to Licensee by this Agreement. Ross Video reserves all rights not expressly licensed to Licensee under section 3.
9. **OPEN SOURCE SOFTWARE.**
  - a. Software may use and/or be provided with Open Source Components, including those detailed in the Third Party section below. To the extent stipulated by its Open Source License, each such Open Source Component is licensed directly to Licensee from its respective licensors and not sub-licensed to Licensee by Ross Video, and such Open Source Component is subject to its respective Open Source License, and not to this Agreement. If, and to the extent, an Open Source Component requires that this Agreement effectively impose, or incorporate by reference, certain disclaimers, permissions, provisions, prohibitions or restrictions, then such disclaimers, permissions, provisions, prohibitions or restrictions shall be deemed to be imposed, or incorporated by reference into this Agreement, as required, and shall supersede any conflicting provision of this Agreement, solely with respect to the corresponding Open Source Component which is governed by such Open Source License.
  - b. If Licensee, or another party on Licensee's behalf, modifies, replaces or substitutes any Open Source Component used in or provided with this Software, Licensee hereby fully, forever, irrevocably and unconditionally releases and discharges Ross Video, its Affiliates and its and their employees, officers, directors, resellers, distributors and representatives (collectively, "Released Parties") from any and all claims, charges, complaints, demands, actions, causes of action, suits, rights, debts, covenants, liabilities, warranties, performance and maintenance and support obligations (collectively, "Released Claims"), of every kind and nature, with respect to such Software, including without limitation any such Released Claims that arise as a matter of applicable Law.
  - c. If an Open Source License requires that the source code of its corresponding Open Source Component be made available to Licensee, and such source code was not delivered to Licensee with the Software, then Ross Video hereby extends a written offer, valid for the period prescribed in such Open Source License, to obtain a copy of the source code of the corresponding Open Source Component, from Ross Video from <https://www.rossvideo.com/open-source-information/>.

## 10. **THIRD PARTY SOFTWARE.**

- a. Licensee acknowledges that the Third Party Software is not owned by Ross Video. Notwithstanding any other provision of this Agreement, Ross Video, to the extent permitted by applicable law, offers no warranties (whether express, implied, statutory or by course of communication or dealing with Licensee, or otherwise) with respect to the Third Party Software. Ross Video may pass through to Licensee, if and to the extent permitted by applicable law, any warranties expressly provided by such third parties to Ross Video for such Third Party Software.
- b. FFmpeg Notice. The Software may utilize FFmpeg video components and their included libraries. FFmpeg is a trademark of Fabrice Bellard (originator of the FFmpeg project). Ross Video disclaims any ownership claim to FFmpeg. Please refer to <http://ffmpeg.org> (copyright is in the FFmpeg developers). FFmpeg is licensed under the GNU Lesser General Public License v2.1 or Lesser General Public License v3.0. GNU Lesser General Public License contact information: Free Software Foundation, Inc., 51 Franklin Street, Fifth Floor, Boston, MA 02110-1301 USA. Licensee can distribute it and/or modify it under the terms of such licenses.

## 11. **INTELLECTUAL PROPERTY INDEMNITY.**

- a. Ross Video agrees to defend, indemnify and hold harmless Licensee from final damages awarded by a court of competent jurisdiction (hereinafter referred to as the "**Losses**"), which Licensee, or any of its officers or directors, may incur, suffer or become liable for as a result of, or in connection with, any third party claim asserted against Licensee to the extent such claim is based on a contention that the Software, Documentation or any portion thereof, infringes any valid, registered, enforceable patents, copyrights, trade secrets, trademarks or other intellectual property rights of any third party, provided that (a) the allegedly infringing Software or Documentation has been used within the scope of and in accordance with the terms of this Agreement, and (b) Licensee notifies Ross Video in writing of such claim within ten (10) days of a responsible officer of Licensee becoming aware of such claim. If the Software, Documentation or any portion thereof is held to constitute an infringement of a third party's intellectual property rights, and use thereof is enjoined, Ross Video shall, at its election and expense, either (i) procure the right to use the infringing element of the Software or Documentation; or (ii) replace or modify the element of the Software or Documentation so that the infringing portion is no longer infringing and still performs the same function without any material loss of functionality. Ross Video shall make every reasonable effort to correct the situation with minimal effect upon the operations of Licensee.
- b. Notwithstanding the above, Ross Video reserves the right to terminate this Agreement and the License granted hereunder on immediate notice to Licensee, and without liability to Licensee, in the event that the Software or Documentation constitutes or may, in Ross Video's determination, constitute, an infringement of the rights of a third party that Ross Video, in its sole discretion, does not consider to be affordably remediable.
- c. Either party may terminate this Agreement immediately should any Software become, or in either party's opinion be likely to become, the subject of a claim of infringement of any intellectual property right and, in such event, there shall be no claim by either Licensee or Ross Video against the other arising out of such termination, provided that the foregoing shall not apply to a claim for infringement by Ross Video against Licensee in the event that Licensee is alleged to have infringed Ross Video's intellectual property rights, in which case Licensee shall remain liable for all outstanding License Fees and other amounts owing to Ross Video.
- d. Notwithstanding the foregoing, Ross Video shall have no liability for any claim of infringement based on use of other than a current, unaltered release of the Software and/or Documentation available from Ross Video if such infringement would have been avoided by the use of a current, unaltered release of the Software and/or Documentation provided that such current, unaltered release performs substantially in conformity with the specifications set out in the Documentation and was provided, at no additional cost by Ross Video, to those subscribing for maintenance services for the Software or Documentation.

12. **CONFIDENTIALITY.** Each Party shall maintain in confidence all Confidential Information of the other Party, shall use such Confidential Information only for the purpose of exercising its rights and fulfilling its obligations under this Agreement, and shall not disclose any Confidential Information of the disclosing Party to any third party except as expressly permitted hereunder or make any unauthorized use thereof. Each Party shall disclose the Confidential Information only to those of its employees, consultants, advisors, and/or subcontractors who have a need to know the Confidential Information. Each Party shall, prior to disclosing the Confidential Information to such employees, consultants, advisors and/or subcontractors, obtain their agreement to receive and use the Confidential Information on a confidential basis on the same terms and conditions contained in this Agreement. The receiving Party shall treat the Confidential Information of the disclosing Party with the same degree of care against disclosure and/or unauthorized use as it affords to its own information of a similar nature, or a reasonable degree of care, whichever is greater. The receiving Party further agrees not to remove or destroy any proprietary or confidential legends or markings placed upon any documents or other materials of the disclosing Party. The obligations of confidence set forth in this Agreement shall extend to any Affiliates that have received Confidential Information of the disclosing Party and shall also cover Confidential Information disclosed by any Affiliate. The receiving Party shall be responsible for any actions or omissions of its Affiliates as if such actions or omissions were its own.

Either party may disclose certain Confidential Information if it is expressly required to do so pursuant to legal, judicial, or administrative proceedings, or otherwise required by law, provided that (i) such Party provides the other Party with reasonable written notice prior to such disclosure; (ii) such Party seeks confidential treatment for such Confidential Information; (iii) the extent of such disclosure is only to the extent expressly required by law or under the applicable court order; and (iv) such Party complies with any applicable protective or equivalent order.

Each of Ross Video and Licensee (the "**Indemnifying Party**", as applicable) agree to indemnify the other (the "**Indemnified Party**", as applicable) for all Losses incurred by the Indemnified Party as a result of a failure of the Indemnifying Party to comply with its obligations under this Section 12 provided that the Indemnified Party has given prompt notice of any such claim and, to the extent that a claim may lie against a third party for the unauthorized disclosure of such Confidential Information, the right to control and direct the investigation, preparation, action and settlement of each such claim and, further, provided that the Indemnified Party reasonably co-operates with the Indemnifying Party in connection with the foregoing and provides the Indemnifying Party with all information in the Indemnified Party's possession related to such claim and such further assistance as reasonably requested by the Indemnifying Party.

The Parties acknowledge and agree that any breach of the confidentiality provisions of this Agreement by one Party may cause significant and irreparable injury to the other Party that is not compensable monetarily, as well as damages that may be difficult to ascertain, and agrees that, in addition to such other remedies that may be available at law or in equity, the other Party shall be entitled to seek injunctive relief (including temporary restraining orders, interim injunctions and permanent injunctions) in a court of competent jurisdiction in the event of the breach or threatened breach by such party of any of the confidentiality provisions of this Agreement. The relief contemplated in this Section shall be available to each Party without the necessity of having to prove actual damages and without the necessity of having to post any bond or other security. Each Party further agrees to notify the other Party in the event that it learns of or has reason to believe that any Person has breached the confidentiality provisions of this Agreement.

13. **LIMITATION OF LIABILITY.** The limitation of liability provisions of this Agreement reflect an informed voluntary allocation of the risks (known and unknown) that may exist in connection with the licensing of the Software or Documentation hereunder by Ross Video, and that voluntary risk allocation represents a material part of the Agreement reached between Ross Video and Licensee. Should Ross Video be in breach of any obligation, Licensee agrees that Licensee's remedies will be limited to those set forth in this Agreement. No action, regardless of form, arising out of this Agreement may be brought by Licensee more than twelve (12) months after the facts giving rise to the cause of action have occurred, regardless of whether those facts by that time are known to, or reasonably ought to have been discovered by, Licensee.

(A) EXCEPT AS EXPRESSLY PROVIDED IN THIS AGREEMENT, THE SOFTWARE AND DOCUMENTATION ARE PROVIDED "AS IS" AND ROSS VIDEO (I) MAKES NO OTHER REPRESENTATIONS, AND PROVIDES NO WARRANTIES OR CONDITIONS OF ANY KIND, EXPRESS OR IMPLIED, STATUTORY, BY USAGE OF TRADE CUSTOM OF DEALING, OR OTHERWISE, AND (II) SPECIFICALLY DISCLAIMS ALL IMPLIED WARRANTIES INCLUDING ANY IMPLIED WARRANTY OF UNINTERRUPTED OR ERROR FREE OPERATION, MERCHANTABILITY, QUALITY OR FITNESS FOR A PARTICULAR PURPOSE. ROSS VIDEO DOES NOT REPRESENT OR WARRANT THAT THE SOFTWARE WILL MEET ANY OR ALL OF LICENSEE'S PARTICULAR REQUIREMENTS, THAT THE USE AND OPERATION OF THE SOFTWARE WILL OPERATE ERROR-FREE OR UNINTERRUPTED, THAT ALL PROGRAMMING ERRORS IN THE SOFTWARE CAN BE FOUND IN ORDER TO BE CORRECTED, OR THAT THE SOFTWARE WILL BE COMPATIBLE WITH OTHER PROGRAMS, SYSTEMS, AND HARDWARE.

(B) IN NO EVENT SHALL ROSS VIDEO, ITS AFFILIATES AND LICENSORS, AND THEIR RESPECTIVE DIRECTORS, OFFICERS, EMPLOYEES AND AGENTS, BE LIABLE FOR ANY CLAIM FOR INDIRECT, CONSEQUENTIAL, SPECIAL, INCIDENTAL, PUNITIVE, EXEMPLARY, AGGRAVATED DAMAGES; LOST PROFITS, OR LOST REVENUE ARISING FROM OR IN CONNECTION WITH THIS AGREEMENT, REGARDLESS OF THE FORM OF ACTION, WHETHER IN CONTRACT, OR IN TORT, EVEN IF THE PARTY HAS BEEN ADVISED OF THE POSSIBILITY OF SUCH DAMAGES.

(C) IN ANY EVENT THE AGGREGATE LIABILITY OF ROSS VIDEO, ITS AFFILIATES AND LICENSORS, AND THEIR RESPECTIVE DIRECTORS, OFFICERS, EMPLOYEES AND AGENTS, FOR ANY CLAIM FOR DIRECT DAMAGES WITH RESPECT TO THE SUBJECT MATTER OF THIS AGREEMENT SHALL NOT EXCEED THE AMOUNT OF THE PURCHASE PRICE PAID TO ROSS VIDEO UNDER THIS AGREEMENT.

14. **TERM AND TERMINATION.**

- (1) Unless terminated earlier in accordance with the terms of this Agreement, the term of this Agreement shall commence upon Licensee's first download, access, installation, or other use of the Software or Documentation and continues until, in the case of Software licensed with Designated Equipment provided by Ross Video, the earliest of (a) the end of the License Period, or (b) if the Designated Equipment is assigned or transferred in accordance with this Agreement, the date on which the Designated Equipment is no longer owned by Licensee;
- (2) Either Party shall have the right to terminate this Agreement on notice to the other Party if:
  - (a) the other Party fails to pay any fees or other amounts when due hereunder or under any other agreement between the Parties (or any Affiliates of the Parties, as applicable) in connection with the Software and/or Designated Equipment and such breach is not cured within thirty (30) days after written notice of such failure to pay is given to the defaulting Party by the non-defaulting Party;
  - (b) the other Party shall file a voluntary petition in bankruptcy or insolvency or shall petition for reorganization under any bankruptcy law, consent to an involuntary petition in bankruptcy, or if a receiving order is given against it under the Bankruptcy and Insolvency Act (Canada) or the comparable law of any other jurisdiction (and such is not dismissed within ten (10) days);

- (c) there shall be entered an order, judgment or decree by a court of competent jurisdiction, upon the application of a creditor, approving a petition seeking reorganization or appointing a receiver, trustee or liquidator of all or a substantial part of the other Party's assets and such order, judgment or decree continues in effect for a period of thirty (30) consecutive days; or
- (d) the other Party shall fail to perform any of the other material obligations set forth in this Agreement and such default, in the case of a default which is remediable, continues for a period of thirty (30) days after written notice of such failure has been given by the non-defaulting Party or, in the case of a non-remediable default, immediately upon notice.

(3) Notwithstanding anything to the contrary contained in this Agreement:

- (a) Ross Video may forthwith terminate this Agreement if Licensee is in breach of any of sections 3, 4 or 12 of this Agreement. For greater certainty, in such instances Ross Video shall provide written notice of such termination as soon as practicable but written notice shall not be a necessary prerequisite to such termination; and
- (b) in the event of a Change of Control of Licensee, Ross Video shall have the right to terminate this Agreement and the License granted hereunder upon thirty (30) days' prior written notice to Licensee. For greater certainty, Ross Video's right to terminate in the event of a Change of Control of Licensee shall continue for a period of six (6) months from the date Licensee delivers notice of such Change of Control to Ross Video.
- (c) Ross Video may terminate the License immediately on the date on which it provides notice to Licensee, if its agreements for Third Party Software are terminated.

(4) Upon the termination or expiry of this Agreement:

- (a) Licensee shall immediately cease and desist all use of the Software and Documentation;
- (b) Licensee shall immediately deliver to Ross Video any of Ross Video's Confidential Information provided hereunder (including the Software and Documentation) then in its possession or control, if any, and shall deliver a certificate of an officer of Licensee certifying the completeness of same;
- (c) Licensee shall refrain from further use of such Confidential Information; and
- (d) Licensee shall forthwith pay all amounts owing to Ross Video or any of its Affiliates hereunder.

15. **SURVIVAL.** The provisions of sections 1, 2, 6, 8, 9, 10, 11, 12, 13, 14, 18, 22, 23, and 24 herein shall survive the expiry or termination of this Agreement.
16. **FORCE MAJEURE.** Dates and times by which Ross Video is required to render performance under this Agreement shall be automatically postponed to the extent and for the period that Ross Video is prevented from meeting them by reason of events of force majeure or any cause beyond its reasonable control provided Ross Video notifies Licensee of the commencement and nature of such cause and uses its reasonable efforts to render performance in a timely manner.
17. **ASSIGNMENT.** Ross Video may assign this Agreement, or any of its rights or obligations hereunder, in whole or in part, upon notice to Licensee. Licensee shall not assign this Agreement, or any of its rights or obligations hereunder, in whole or in part, without the prior written consent of Ross Video, which consent may not be unreasonably withheld. This Agreement enures to the benefit of and is binding upon each of the Parties and their respective successors and permitted assigns.

18. **GOVERNING LAW.** If Licensee acquired the Ross Product(s) in the United States or Canada, the laws of the state or province where Licensee's principal place of business is located govern the interpretation of this Agreement, claims for its breach, and all other claims regardless of conflict of laws principles. If Licensee acquired the Ross Product(s) in the European Union or the United Kingdom, then the laws of England and Wales apply. If Licensee acquired the Ross Product(s) in any other country, then the laws of the Province of Ontario, Canada shall apply.
19. **LANGUAGE.** The Parties have expressly required that this Agreement and all documents relating thereto be prepared in English. Les parties ont expressément exigé que cette convention ainsi que tous les documents qui s'y rattachent soient rédigés en anglais.
20. **GOVERNMENT CONTRACTS.** If the Software and/or Documentation to be furnished to Licensee hereunder are to be used in the performance of a government contract or subcontract, the Software and/or Documentation shall be provided on a "restricted rights" basis only and Licensee shall place a legend, in addition to applicable copyright notices, in the form provided under the applicable governmental regulations. For greater certainty, Ross Video shall not be subject to any flow-down provisions required by any customer of Licensee that is a Governmental Authority unless Ross Video expressly agrees to be bound by such flow-down provisions in writing.
21. **EXPORT AND IMPORT LAWS.** Licensee acknowledges and agrees that the Software (including any technical data and related technology) may be subject to the export control laws, rules, regulations, restrictions and national security controls of the United States and other applicable countries (the "**Export Controls**") and agrees not to export, re-export, import or allow the export, re-export or import of such export-controlled Software (including any technical data and related technology) or any copy, portion or direct product of the foregoing in violation of the Export Controls. Licensee hereby represents that it is not an entity or person to whom provision of the Software (including any technical data and related technology) is restricted or prohibited by the Export Controls. Licensee agrees that it has the sole responsibility to obtain any authorization to export, re-export, or import the Software (including any technical data and related technology), as may be required. Licensee will defend, indemnify and hold Ross Video harmless from any and all claims, losses, liabilities, damages, fines, penalties, costs and expenses (including attorney's fees) arising from or relating to any breach by Licensee of its obligations under this Section.
22. **AMENDMENT AND WAIVER.** No amendment, discharge, modification, restatement, supplement, termination or waiver of this Agreement or any Section of this Agreement is binding unless it is in writing and executed by the Party to be bound. No waiver of, failure to exercise or delay in exercising, any Section of this Agreement constitutes a waiver of any other Section (whether or not similar) nor does any waiver constitute a continuing waiver unless otherwise expressly provided.
23. **SEVERABILITY.** Each Section of this Agreement is distinct and severable. If any Section of this Agreement, in whole or in part, is or becomes illegal, invalid, void, voidable or unenforceable in any jurisdiction by any court of competent jurisdiction, the illegality, invalidity or unenforceability of that Section, in whole or in part, will not affect (a) the legality, validity or enforceability of the remaining Sections of this Agreement, in whole or in part; or (b) the legality, validity or enforceability of that Section, in whole or in part, in any other jurisdiction.
24. **ENTIRE AGREEMENT.** This Agreement, and any other documents referred to herein, constitutes the entire agreement between the Parties relating to the subject matter of this Agreement and supersedes all prior written or oral agreements, representations and other communications between the Parties.

*Updated: November 1, 2023*

# Warranty and Repair Policy

Ross Video Limited (Ross) warrants its XPression systems to be free from defects under normal use and service for the following time periods from the date of shipment:

- XPression Server — 12 months
- XPression Software Upgrades — 12 months free of charge
- System and Media hard drives — 12 months

If an item becomes defective within the warranty period Ross will repair or replace the defective item, as determined solely by Ross.

Warranty repairs will be conducted at Ross, with all shipping FOB Ross dock. If repairs are conducted at the customer site, reasonable out-of-pocket charges will apply. At the discretion of Ross, and on a temporary loan basis, plug in circuit boards or other replacement parts may be supplied free of charge while defective items undergo repair. Return packing, shipping, and special handling costs are the responsibility of the customer.

This warranty is void if products are subjected to misuse, neglect, accident, improper installation or application, or unauthorized modification.

In no event shall Ross Video Limited be liable for direct, indirect, special, incidental, or consequential damages (including loss of profit). Implied warranties, including that of merchantability and fitness for a particular purpose, are expressly limited to the duration of this warranty.

This warranty is TRANSFERABLE to subsequent owners, subject to Ross' notification of change of ownership.

## Extended Warranty

For customers that require a longer warranty period, Ross offers an extended warranty plan to extend the standard warranty period by one year increments. For more information about an extended warranty for your XPression system, contact your regional sales manager.

# Environmental Information

The equipment that you purchased required the extraction and use of natural resources for its production. It may contain hazardous substances that could impact health and the environment.

To avoid the potential release of those substances into the environment and to diminish the need for the extraction of natural resources, Ross Video encourages you to use the appropriate take-back systems. These systems will reuse or recycle most of the materials from your end-of-life equipment in an environmentally friendly and health conscious manner.

The crossed-out wheeled bin symbol invites you to use these systems.



If you need more information on the collection, reuse, and recycling systems, please contact your local or regional waste administration.

You can also contact Ross Video for more information on the environmental performances of our products.

# Company Address

## **Ross Video Limited**

8 John Street  
Iroquois, Ontario  
Canada, K0E 1K0

## **Ross Video Incorporated**

P.O. Box 880  
Ogdensburg, New York  
USA 13669-0880

---

**General Business Office:** (+1) 613-228-0688

**Toll Free:** (+1) 844-652-0645

**Fax:** (+1) 613-652-4425

**Toll Free Technical Support:** 1-833-859-0499 (North America)  
+800 3540 3545 (International)

**Alternately, you can contact:**

**Technical Support:** (+1) 613-686-1557

**Australia/Sydney Local Support:** 1300 007 677\*

**E-mail for Technical Support:** [techsupport@rossvideo.com](mailto:techsupport@rossvideo.com)

**E-mail for General Information:** [solutions@rossvideo.com](mailto:solutions@rossvideo.com)

**Website:** <http://www.rossvideo.com>

\*If the local support specialist is not available, your call will be transferred automatically to our North America center.

# Contents

<b>Introduction</b> .....	<b>1</b>
About This Guide .....	2
Getting Help .....	3
<b>XPression Clips Components and Workflow Overview</b> .....	<b>4</b>
XPression Clip Store .....	5
XPression Clip Store Manager .....	6
XPression .....	7
Clip Browser .....	7
Server Channels .....	7
Clip Editor .....	7
PBus Mapping .....	7
Record Client .....	7
XPression Media Control Gateway .....	8
XPression INcoder .....	9
Clips Workflow .....	10
Clips Configuration with Synchronized Clip Store Databases .....	11
Clips Workflow Using the Record Client .....	12
Clips Workflow Using the XPression INcoder .....	13
Clips MOS Workflow .....	15
<b>XPression Clip Store Setup</b> .....	<b>16</b>
Installing an SSL Certificate .....	17
XPression Clip Store Manager Interface Overview .....	22
Starting and Stopping XPression Clip Store .....	23
Starting the Clip Store Manager .....	24
Configuring the Clip Store .....	26
Adding User Roles .....	28
Adding Users .....	30
Synchronizing Multiple Clip Stores .....	33
Viewing the Transfer Status When Syncing Servers .....	35
Receiving Files On a Synced Server .....	36
Outgoing Files from a Clips Server .....	37
Browsing and Deleting Clips .....	38
Clips List .....	39
Search .....	41

Projects .....	42
Projects List .....	43
Wiping the Clips Database .....	44
Configuring XPression Studio, BlueBox, and Gateway for XPression	
Clip Store .....	45
XPression Studio .....	46
XPression BlueBox .....	47
XPression Gateway .....	48
<b>XPression Media Control Gateway .....</b>	<b>50</b>
Media Control Gateway Interface Overview .....	51
Opening the XPression Media Control Gateway Settings .....	52
Configuring the General Settings .....	53
Configuring the AMP Settings .....	55
Supported AMP Commands .....	58
Configuring the VDCP Settings .....	59
Supported VDCP Commands .....	62
<b>XPression INcoder .....</b>	<b>63</b>
XPression INcoder Overview .....	65
INcoder Terminology .....	65
INcoder User Interface Overview .....	66
The XPression INcoder - Tasks Tab .....	67
The XPression INcoder - Configuration Tab .....	67
Configuring the XPression INcoder .....	69
Engine .....	71
Users .....	74
Projects .....	77
Targets .....	82
Processors .....	85
Sources .....	91
XPression INcoder Tasks .....	96
Task List Shortcut Menu - INcoder Engine .....	99
Task List Shortcut Menu - Video .....	99
<b>Using XPression Clips .....</b>	<b>100</b>
Setting Up Server Channels .....	101
Adding a Server Channel .....	102
Adding a Preview Output to a Server Channel .....	104
XPression Clips Playback Overview .....	106
Clip Browser Interface Overview .....	107

Using the Clip Browser .....	108
Opening the Clip Browser .....	109
Clip Browser Interface .....	110
Server Channels .....	114
Opening the Server Channels .....	115
Loading a Clip in the Server Channels .....	116
Using the Server Channels .....	119
Edit Clip/Add Sub Clip .....	123
Updating the Thumbnail in the Clip Browser .....	129
Creating a 4-Point Loop .....	132
Creating a 3-Point Loop .....	134
Send a Video or Image to Clip Store Using the Record Client .....	136
Preset Event Tracks .....	140
<b>PBus .....</b>	<b>151</b>
PBus Overview .....	152
Configuring PBus and PBus Recalls .....	153
PBus Triggers .....	156
PBus LEARN Commands .....	158
PBus Mapping .....	159
Configuring PBus Mapping .....	159
Assigning an Action to a PBus Register .....	162
Remapping a PBus Register .....	164
Loading and Saving Maps .....	168
Using PBus from a Switcher to Recall Items .....	169
Using PBus for XPression Clips .....	170
Using PBus for XPression Clips with Recall IDs .....	171

# Introduction

Pre-rolls are a thing of the past with XPression Clips, a production clip server for live production that incorporates the latest advances in IT technologies. Built on the industry-leading XPression real-time graphics platform, XPression Clips offers you instant recall times and back-to-back clip transitions from an intuitive user interface or via automation triggers from other devices like Ross Video productions switchers.

You can simultaneously ingest multiple channels of baseband video and output multiple channels of clips to air. Both NAS and SAN configurations are available for attached storage, in addition to ample local hard drive space. Database management and synchronization are possible with the Clip Store that supports user rights and roles.

You can also add XPression Clips functionality to XPression Studio's basic clip handling capabilities by adding the XPression Clips Option.

Key features of XPression Clips and the XPression Clips Option include:

- Multi-channel ingest and playout
- 1, 2, or 4 channels of baseband video ingest
- 2 or 4 channels of playout (user-definable fill/fill or fill/key configuration)
- Back-to-back transitions
- Multiple clips on the same output
- Clip Browser with searching
- Clip trimming and looping
- VDCP, AMP, PBus, and RossTalk automation protocols
- PBus Manager for intelligent clip assignment
- Clip Manager application with user rights for database management and synchronization setup
- NAS or SAN attached storage with SNS storage (Studio Network Solutions)

Streamline your production clips workflow with Ross Video's next-generation production clip servers and transcoding applications. Available in multiple configurations, XPression Clips/XPression Clips Option and the Clip Server Option for XPression Studio bring lightning-fast recall speeds, baseband video ingest, and multi-layer clip playback to the control room.

# About This Guide

This guide covers the use of the XPression system.

If, at any time, you have questions pertaining to the operation of XPression, please contact us at the numbers listed in the section [Getting Help](#). Our technical staff is always available for consultation, training, or service.

## Documentation Conventions

Special text formats are used in this guide to identify parts of the user interface, text that a user must enter, or a sequence of menus and sub-menus that must be followed to reach a particular command.

### **Bold text**

Bold text identifies a user interface element such as a dialog box, menu item, or button.

For example:

In the **Slug** column, type a slug name for the story.

### *Italic text*

Italic text is used to identify the titles of referenced guides, manuals, or documents.

For example:

For more information, refer to the *DashBoard User Guide*.

### Courier text

Courier text identifies text that a user must type.

For example:

In the **Username** box, type `postgres`.

### Menu Sequences

Menu arrows are used in procedures to identify a sequence of menu items that you must follow.

For example:

If a step reads **Server > Save As**, you would select the **Server** menu and then select **Save As**.

### [Hypertext](#)

Identifies a hyperlink to a related topic.

## Getting Help

XPression documentation is available online at [Product Documentation](#) and is also accessible on the product USB key and by selecting the **Help** icon in the user interface.

## Contacting Technical Support

At Ross Video, we take pride in the quality of our products, but if problems occur, help is as close as the nearest telephone.

Our 24-hour Hot Line service ensures you have access to technical expertise around the clock. After-sales service and technical support is provided directly by Ross Video personnel. During business hours (Eastern Time), technical support personnel are available by telephone. After hours and on weekends, a direct emergency technical support phone line is available. If the technical support person who is on call does not answer this line immediately, a voice message can be left and the call will be returned shortly. This team of highly trained staff is available to react to any problem and to do whatever is necessary to ensure customer satisfaction.

### Technical Support:

- 1-613-686-1557
- 1-833-859-0499 (Toll free within North America)
- +800 3540 3545 (Toll free International)
- 1300 007 677 (Australia/Sydney)\*
- E-mail: [techsupport@rossvideo.com](mailto:techsupport@rossvideo.com)
- Website: <http://www.rossvideo.com>

\*If the local support specialist is not available, your call will be transferred automatically to our North America center.

# XPression Clips Components and Workflow Overview

The following components of the XPression Clips workflow are discussed in this section:

[XPression Clip Store](#)

[XPression](#)

[XPression Media Control Gateway](#)

[XPression INcoder](#)

[Clips Workflow](#)

## XPression Clip Store

The XPression Clip Store is a windows service that serves as the database to hold clips within a clip workflow. The database contains pointers to the clips on disk as well as all of the metadata associated with a clip, such as the name, recall ID, in/out points, sub clip info, etc.

The XPression Clip Store can run on any physical machine, but in the basic workflow would generally run on the XPression machine itself.

The XPression Clip Store has the capability to replicate clips and metadata to other clip stores in the workflow. For example, if you have several XPression machines and run a local Clip Store on each, then those clip stores can be kept up to date through automated database/clip syncing. Syncing can also be used to create a backup Clip Store to use if the primary machine is taken offline (there is no automatic failover).

The XPression Clip Store has users and user rights assignment features to allow users to be created with permissions to perform different tasks such as trimming, deletion, sync, and administration.

## XPression Clip Store Manager

The XPression Clip Store Manager is a user application that connects to the Clip Store service (on a local or remote machine). The Clip Store Manager is used to administer the users, synchronization settings, and clips.

Extensive search capabilities for browsing the clips is provided and clips can be deleted from the Clip Store Manager.

# XPression

The following components are used in the Clips workflow.

If using the XPression Clips Option, the following components are accessed in the XPression Sequencer mode, with the exception of the Record Client, which can be accessed in the Layout mode as well.

## Clip Browser

The Clip Browser is a window in the XPression Sequencer used for dragging and dropping clips into the Sequencer or Server Channels.

## Server Channels

The Server Channels window is located in the XPression Sequencer and is used for previewing and playing out clips. Clips can also be edited from the Server Channels window.

These channels represent a server channel as on a typical video server. The virtual channels are created in the Server Channels tab of the Hardware Setup in XPression.

## Clip Editor

From the Clip Browser or the Server Channels, a selected clip can be opened in the Edit Clip window for editing.

## PBus Mapping

A PBus Mapping menu exists in the XPression Sequencer to provide additional capabilities to the PBus recall system. By assigning a PBus device ID to a server channel, clips from the Clip Browser can be assigned to a PBus register simply by dragging them from the Clip Browser onto a PBus register.

## Record Client

Use the Record Client dialog box to record an incoming SDI video as a video file or as a still image.

Up to four streams can be recorded simultaneously, however, each stream affects overall system performance, so with four streams recording it is unlikely you will be able to playback graphics simultaneously without dropping frames. Recording to network locations (NAS/SAN) may or may not be possible depending on the bandwidth available. The number of audio channels to record can be varied between 0 and 16. Recordings are made to the XPression Video Codec avi format.

## XPression Media Control Gateway

The XPression Media Control Gateway is used to receive AMP or VDCP connections to control XPression with XPression Clip Store. AMP/VDCP can be received over either TCP or Serial (RS232) connections.

For RS422 support, an external converter must be used.

One Media Control Gateway is required for each XPression machine.

This gateway connects directly to an XPression machine, but also connects to the XPression Clip Store to retrieve the entire clip list.

## XPression INcoder

The XPression INcoder is a separate, optional component to the XPression Clips workflow. For more information, or to purchase the INcoder, contact Ross Video.

The XPression INcoder is a windows service that manages one or more watchfolders used for file based ingest of clips into the XPression Clips workflow. The INcoder performs transcoding functions to convert clips from compatible formats into XPression Codec AVI files. The same formats supported by the XPression Video Coder can be transcoded by the INcoder.

### **For More Information on...**

- the XPression INcoder, refer to the *XPression INcoder User Guide*.

## Clips Workflow

The following diagrams illustrate examples of the XPression Clips workflow options:

[Clips Configuration with Synchronized Clip Store Databases](#)

[Clips Workflow Using the Record Client](#)

[Clips Workflow Using the XPression INcoder](#)

[Clips MOS Workflow](#)

## Clips Configuration with Synchronized Clip Store Databases

The following diagram illustrates an example of the XPression Clips workflow setup using synchronized Clip Store databases in a non-MOS workflow.

### XPression Clips Configuration with Synchronized Clip Store Databases

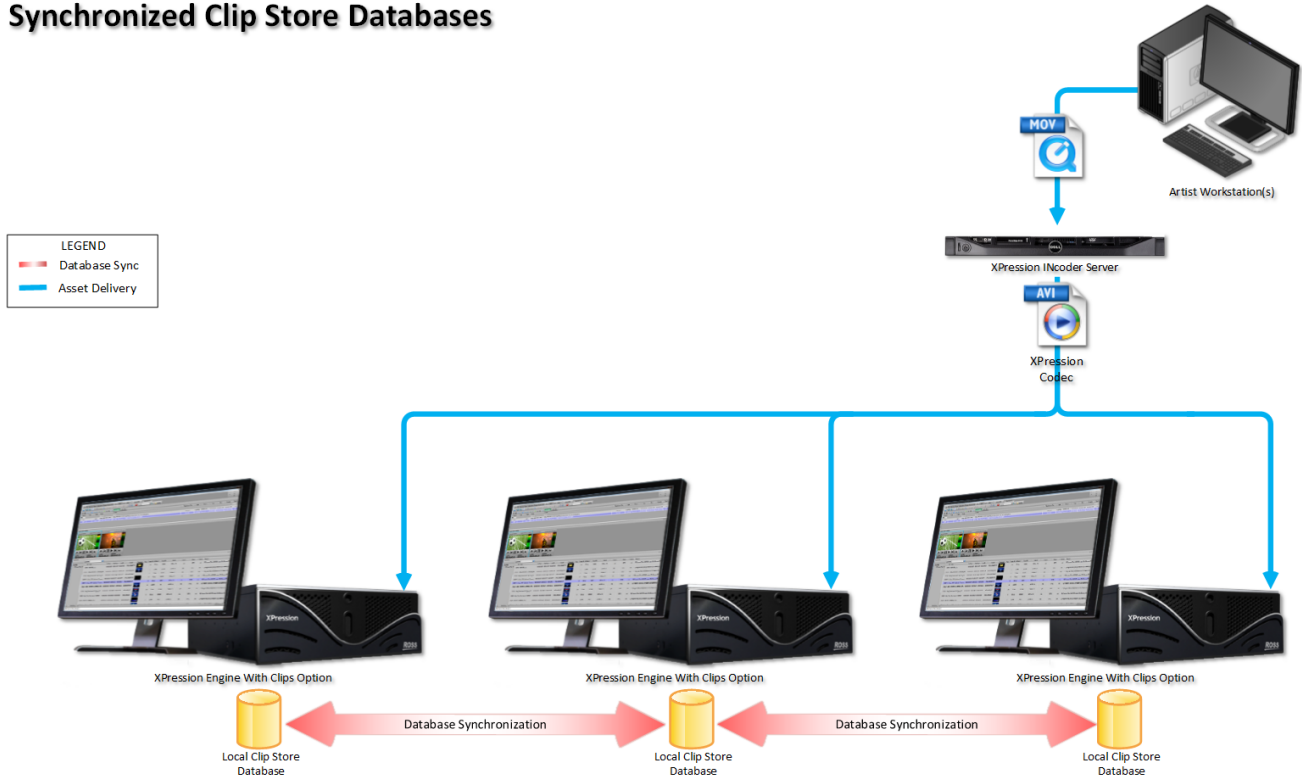

*Clips Workflow Configuration when Using Multiple Workstations and Synchronized Clip Store Databases*

## Clips Workflow Using the Record Client

The following diagram illustrates an example of the XPression Clips workflow setup using the Record Client.

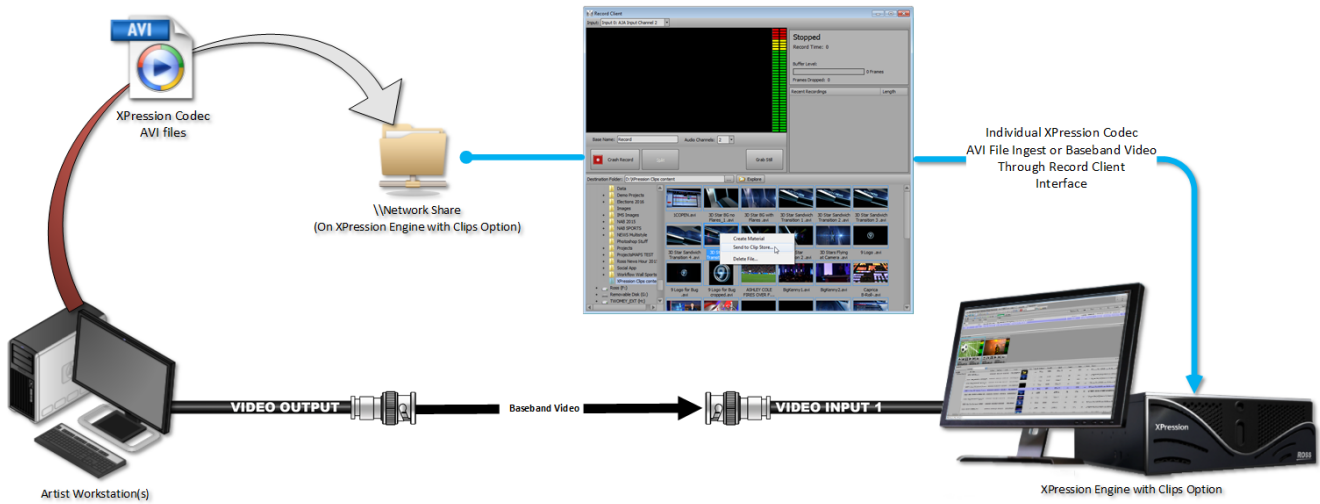

### XPression Clips Configuration Example Single Engine and No INcoder Software or Hardware



*Clips Workflow Configuration when Using a Single Engine and the Record Client*

## Clips Workflow Using the XPression INcoder

The following diagrams illustrate examples of the XPression Clips workflow setup using multiple engines on the XPression INcoder server and using a customer supplied PC.

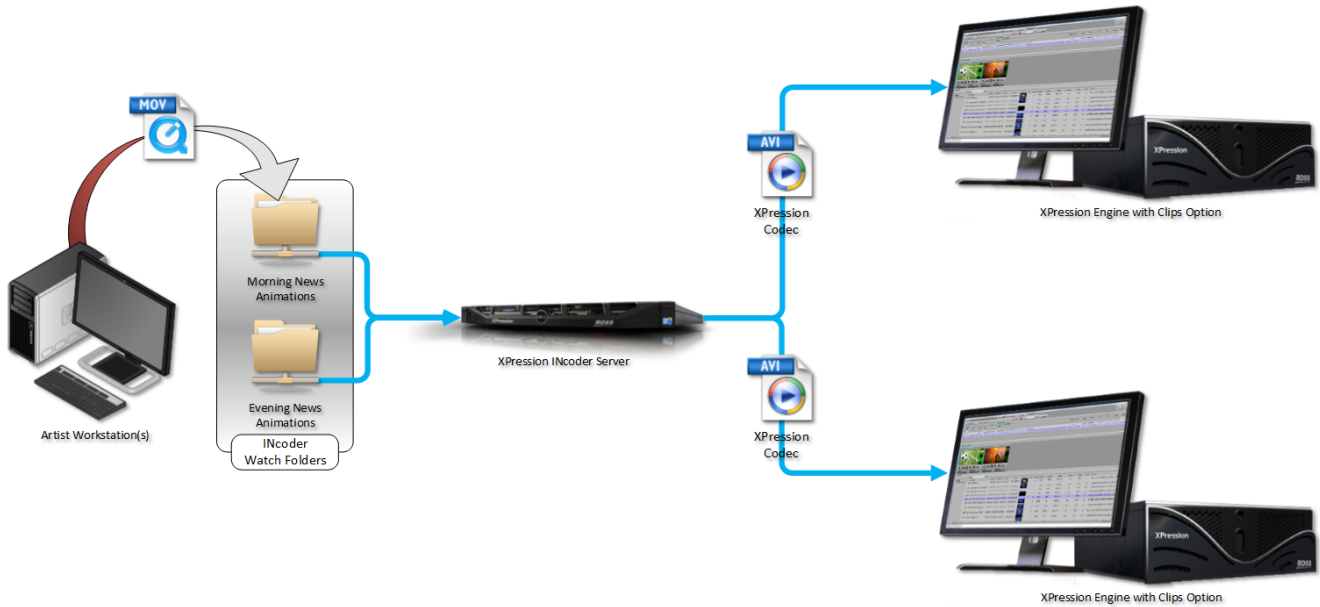

### XPression Clips Configuration Example Multiple Engines and an INcoder Server



*Clips Workflow Configuration when Using Multiple Engines and the INcoder Server*

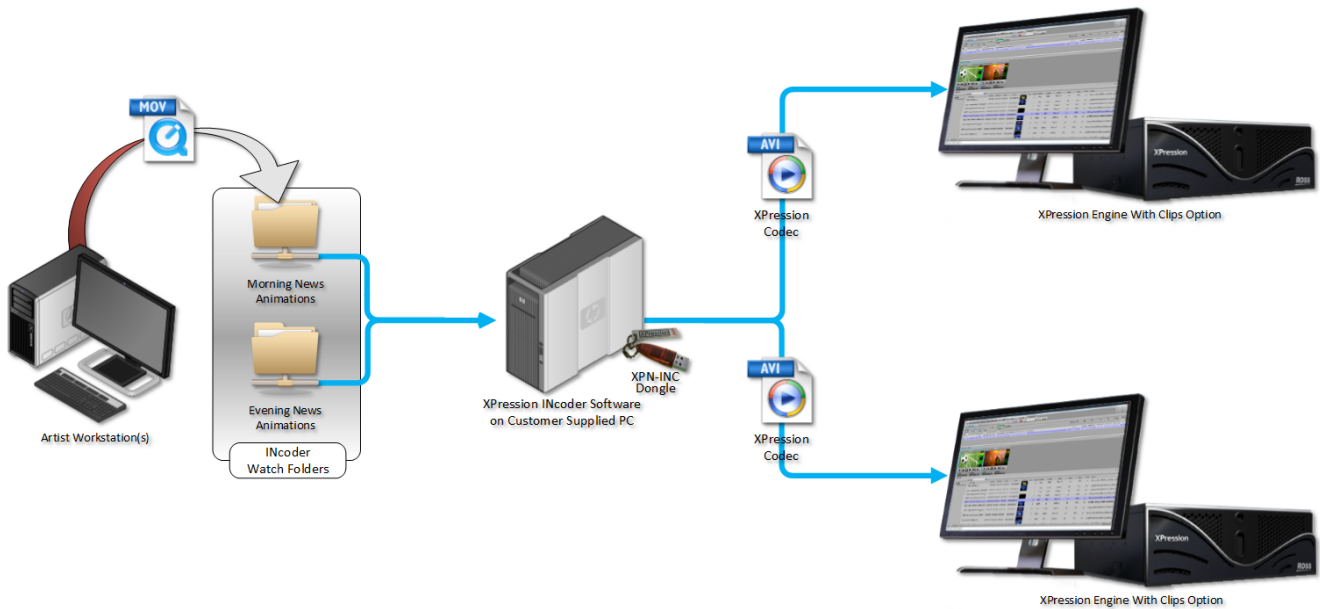

## XPression Clips Configuration Example

Multiple Engines and INcoder on a Customer Supplied PC

*Clips Workflow Configuration when Using Multiple Engines and the INcoder on a Customer Supplied PC*

## Clips MOS Workflow

The following diagram illustrates an example of the XPression Clips workflow setup using synchronized Clip Store databases in a MOS workflow.

### XPression Clips MOS Configuration with Synchronized Clip Store Databases

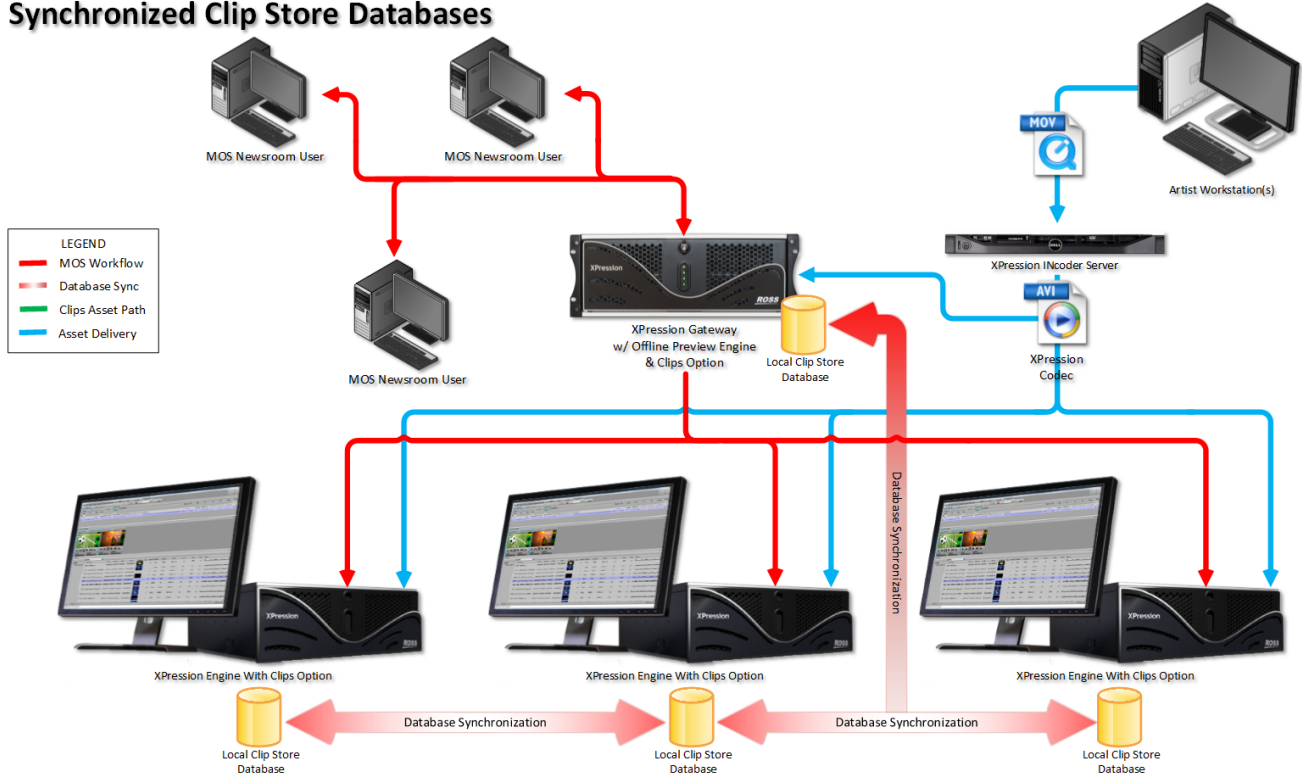

*Clips Workflow Configuration when Using Multiple Workstations and Synchronized Clip Store Databases in a MOS workflow*

# XPression Clip Store Setup

Once XPression has been installed, install and set up the XPression Clip Store.

For installation instructions, see the *XPression Clip Store Installation Guide*.

[Installing an SSL Certificate](#)

[XPression Clip Store Manager Interface Overview](#)

[Starting and Stopping XPression Clip Store](#)

[Starting the Clip Store Manager](#)

[Configuring the Clip Store](#)

[Adding User Roles](#)

[Adding Users](#)

[Synchronizing Multiple Clip Stores](#)

[Viewing the Transfer Status When Syncing Servers](#)

[Browsing and Deleting Clips](#)

[Projects](#)

[Wiping the Clips Database](#)

[Configuring XPression Studio, BlueBox, and Gateway for XPression Clip Store](#)

# Installing an SSL Certificate

In order for the XPression Clip Store to operate over SSL/HTTPS connections, an SSL certificate must be purchased and installed on the XPression Gateway server. This section outlines the steps.

## Prerequisites

A purchased SSL certificate from a trusted root authority (our certificates are purchased from DigiCert, so these instructions will use the steps for DigiCert as an example).

## Buying an SSL Certificate

To purchase an SSL certificate, a CSR file must be generated and sent to the certificate authority. The CSR file describes the server machine that will hold the certificate as well as the Company and Organization details for the purchaser. This must be generated on the Gateway machine and must be registered against the server/domain that the Clip Store will use to connect to the gateway.

The CSR can usually be generated using a tool provided by the Certificate Authority (or they should provide documentation on how to generate the CSR).

When purchasing from DigiCert, the platform can be specified as "Other". This will provide you with .CRT files containing the certificates.

## Installing the Certificate

DigiCert provides a DigiCert Key Utility that can be used to install the three certificate files (Root, Intermediate, and the actual gateway certificate).

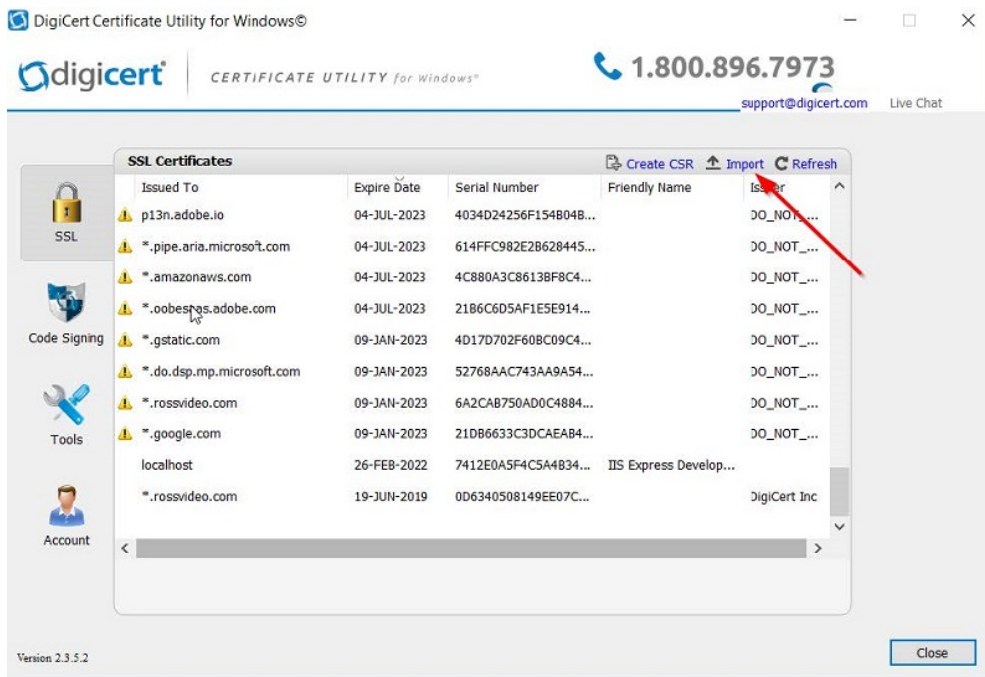

### SSL Certificate from Certificate Authority

Once the certificates have been installed, they must be configured and bound to the port that the XPression Gateway will use.

## To add the Snap-in:

1. Open **Windows MMC** by pressing **Win+R**, typing **MMC** and pressing **Enter**.
2. In the **Console1** window, from the **File** menu, select **Add/Remove Snap-in**.
3. In the **Available snap-ins** list, double-select **Certificates**.

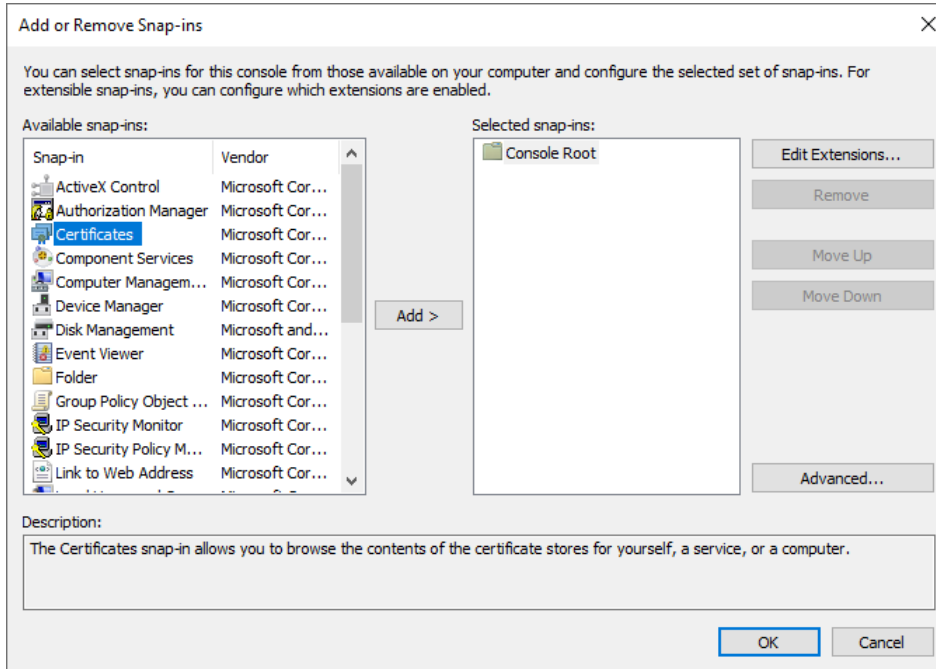

SSL - Add/Remove Snap-ins

4. In the **Certificates snap-in** dialog, select **Computer Account** and select **Next**.

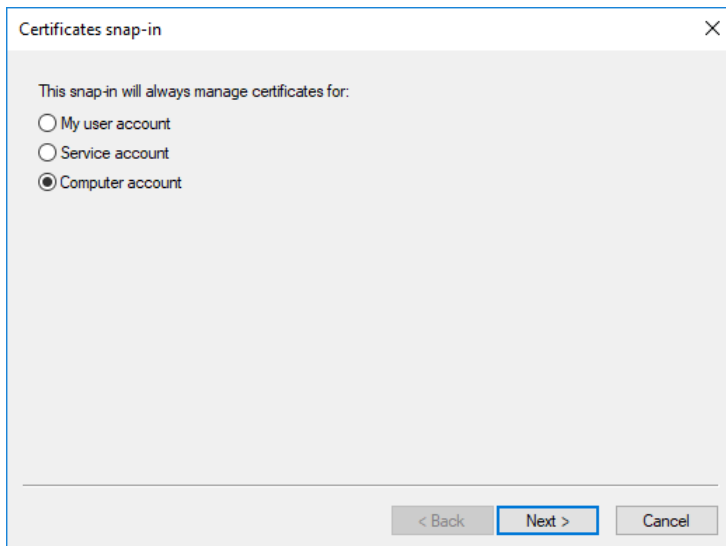

SSL - Certificates Snap-in

5. In the **Select Computer** dialog, select **Local Computer** and select **Finish**.

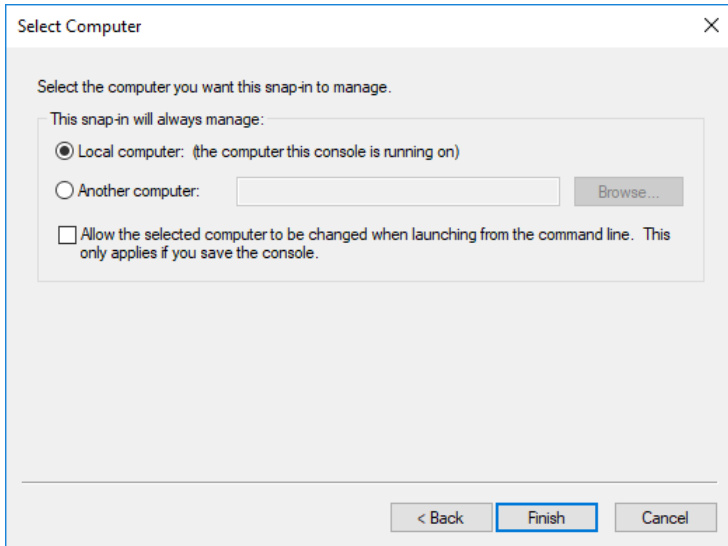

SSL - Select Computer

6. In the **Add or Remove Snap-ins** dialog, select **OK**.

### To select the certificate:

1. In the **Certificates** folder, select **Personal > Certificates** and find the certificate.

In this example, it is \*.rossvideo.com.

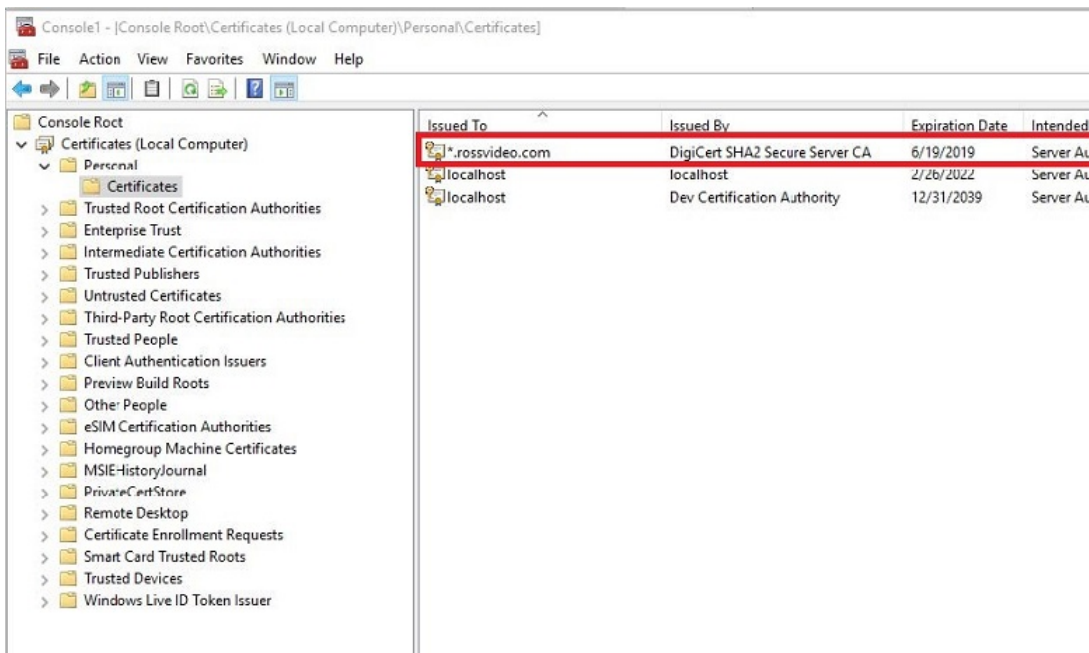

SSL - Select Certificate

2. Double-click the certificate and go to **Details->Thumbprint**.

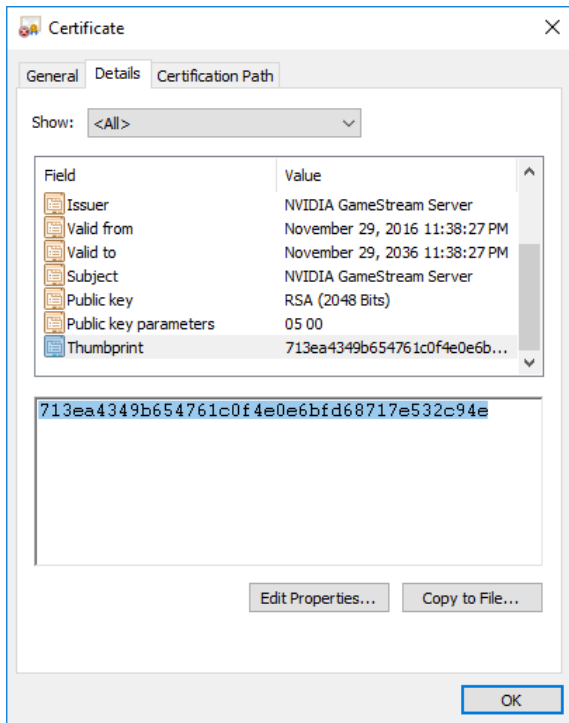

SSL - Certificate Details

3. Copy and paste the thumbprint text to a clipboard or notepad and then close the **Certificate** dialog.

4. Open the **Windows Command Prompt** console as administrator and run the following command:

```
netsh http add sslcert ipport=0.0.0.0:9444 certhash=%thumbprint%appid={B7D308CE-E9CE-4F75-BBF8-842155CF8638}
```

where %thumbprint% will be the thumbprint you copied from **MMC**.

A message should be received indicating successful installation of the certificate.

#### **To remove a certificate from a port:**

- Open the **Windows Command Prompt** console as administrator and run the following command:

```
netsh http delete sslcert ipport=0.0.0.0:9444
```

Existing bindings must be deleted before a certificate can be reassigned to an existing port.

**To see a list of bound SSL certificates to ports:**

- Open the Windows command prompt console as administrator and run the following command:  
`netsh http show sslcert`

If the certificate is correctly bound, it will appear as follows:

```
IP:port                : 0.0.0.0:9444
Certificate Hash       : ff13964b09b055be3e275b5d3b935568a72462b0
Application ID        : {3cf6a009-07a4-4a80-bb43-f3a6e147b00a}
Certificate Store Name : (null)
Verify Client Certificate Revocation : Enabled
Verify Revocation Using Cached Client Certificate Only : Disabled
Usage Check           : Enabled
Revocation Freshness Time : 0
URL Retrieval Timeout : 0
Ctl Identifier        : (null)
Ctl Store Name        : (null)
DS Mapper Usage       : Disabled
Negotiate Client Certificate : Disabled
Reject Connections    : Disabled
Disable HTTP2         : Not Set
```

*SSL - Certificate Successfully Bound*

# XPression Clip Store Manager Interface Overview

The following screen capture displays the main elements of the XPression Clip Store Manager.

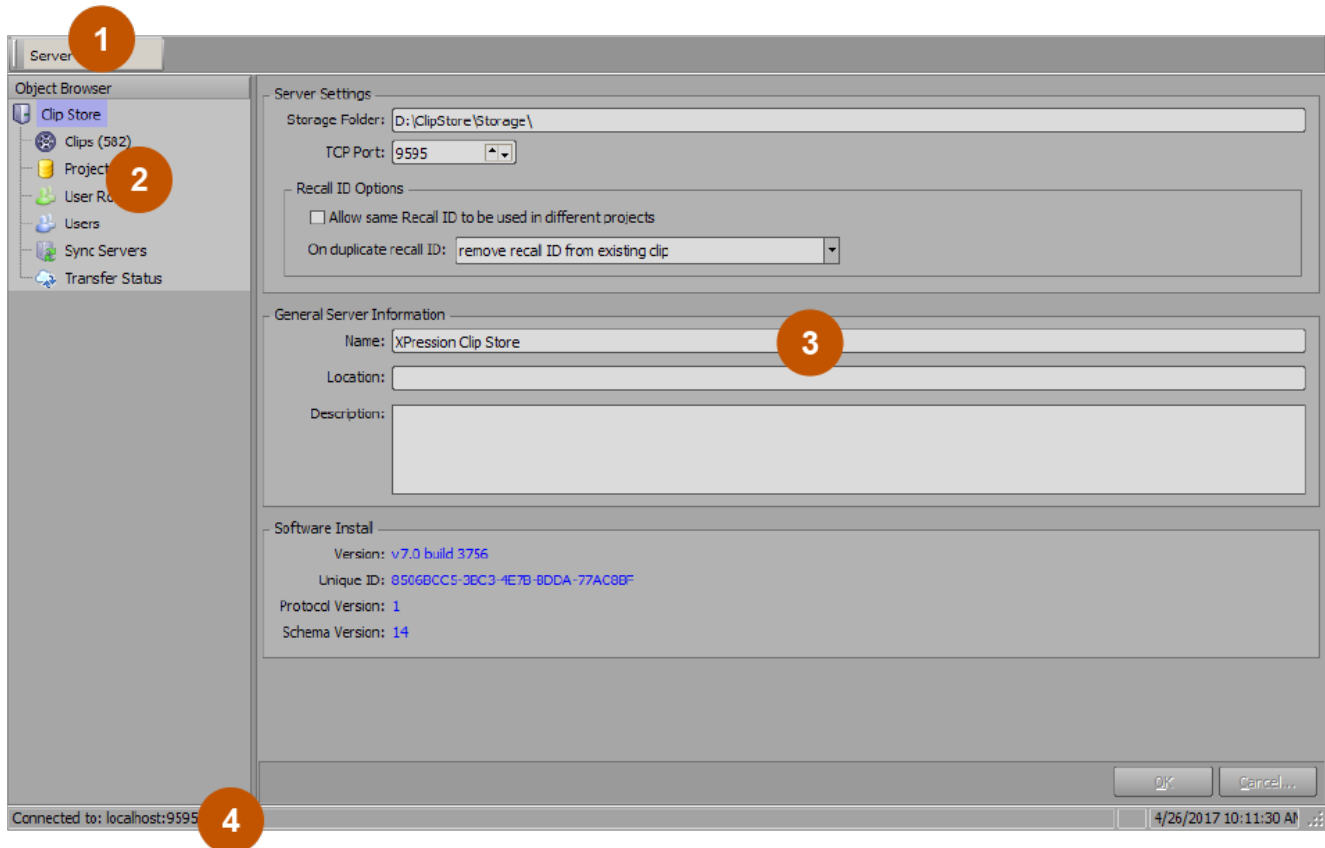

1. **Menu Bar** — use this menu bar to access the **Server** menu.

2. **Object Browser** — use this area to browse clips, select a project, add users, define user roles, add servers in which to sync, and view the status of transfers.

3. **Main Window** — use this window to configure or edit the selected item from the Object Browser.

4. **Status Area** — displays the current connection status of the Clip Store.

# Starting and Stopping XPression Clip Store

XPression Clip Store services are automatically started after installation. However, if the option to start after install is de-selected or if the service has been stopped at any point, use the following procedure to start the Clip Store service.

## To start the Clip Store:

1. On the machine that has the XPression Clip Store installed, locate the XPression Clip Store folder using the **Start** menu.
2. Select **Start Clip Store** ().

If the Clip Store has successfully started, an information message indicates that the XPression Clip Store was successfully started.

## To stop the Clip Store:

1. On the machine that has the XPression Clip Store installed, locate the XPression Clip Store folder using the **Start** menu.
2. Select **Stop Clip Store** ().

If the Clip Store has been successfully stopped, an information message indicates that the XPression Clip Store was successfully stopped.

# Starting the Clip Store Manager

Use the XPression Clip Store Manager to connect to XPression Clip server.

## To connect to the XPression Clip server:

1. On the machine that has the XPression Clip Store installed, locate the XPression Clip Store folder using the **Start** menu and select Clip Store Manager.

The **Connect to Clip Store server** dialog opens.

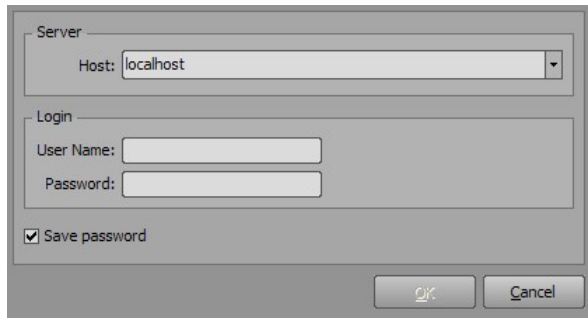

2. In the **Server** section, in the **Host** field, enter the IP address of the Clip Store service if using remotely.

### OR

If using the Clip Store service locally, select **localhost** from the drop-down.

This is the server from which the clips will be synchronized.

3. In the **Login** section, in the **User Name** field, enter the login name of the user.

The default user name is `admin`.

4. In the **Password** field, enter the password for the user.

The default password is `admin`.

5. Select the **Save password** checkbox to automatically enter the login credentials for subsequent connections to the Clip Store server.

6. Select **OK**.

The **XPression Clip Store Manager** opens.

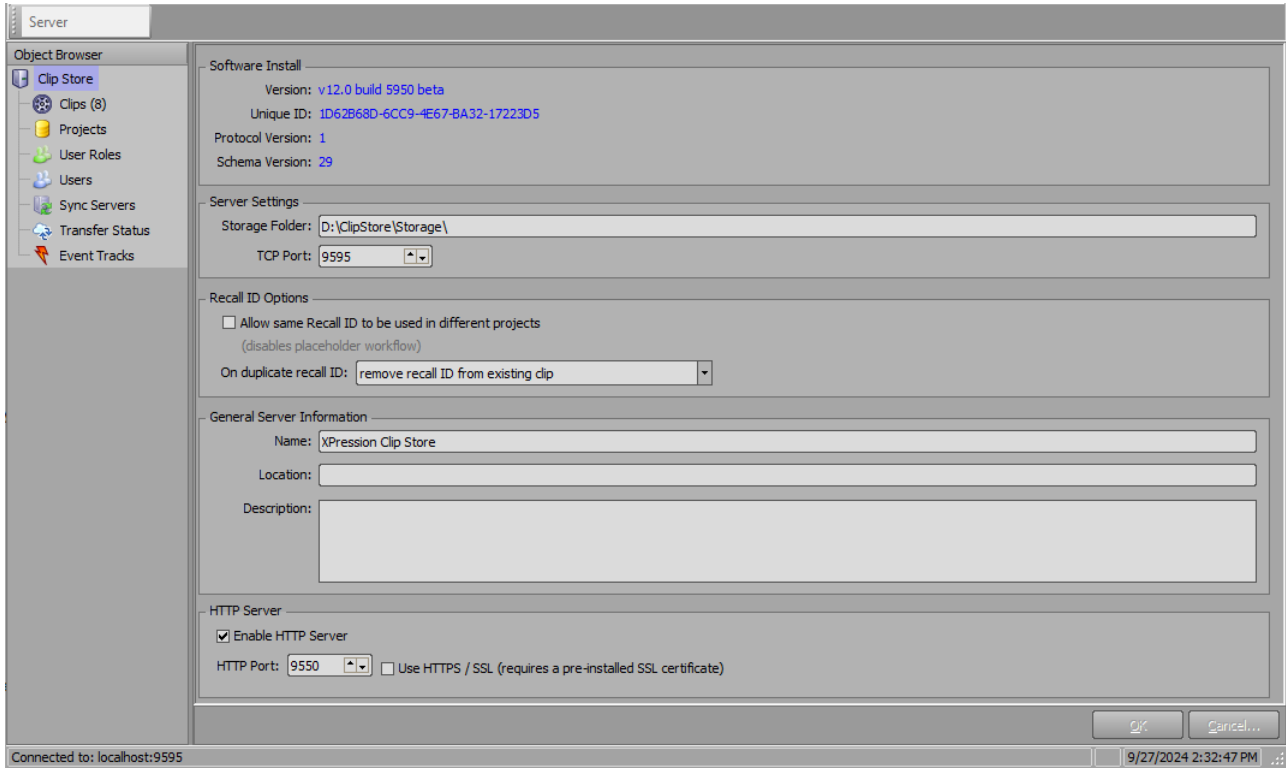

# Configuring the Clip Store

In the XPression Clip Store Manager, use the **Server Settings** section to configure the server details.

## To configure the server settings:

1. In the **Server Settings** section, in the **Storage Folder** field, enter a file path for the folder where clips are stored.

The default file path is **D:\ClipStore\Storage**.

### OR

If the machine does not use a **D:\** media drive, the default path will be **C:\Program Files (x86)\XPression Clip Store\Storage\**.

If exporting sequencer take items as videos/images to a remote ClipStore, the storage folder of the remote ClipStore must be shared. The UNC path of the shared folder must be entered in the **Storage Folder** field of the ClipStore manager on the sequencer engine.

★ If this value is being changed after clips have already been ingested into the system, you will need to manually copy the contents of the **D:\ClipStore\Storage** to the new folder. A warning will be presented to remind you to do so:

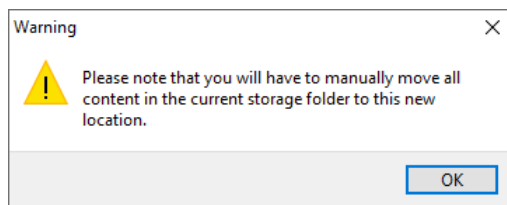

The new path should contain three subfolders: **Clips**, **Thumbnails**, and **Flipbooks**.

The Clip Store must be restarted after changing the storage folder location.

2. In the **TCP Port** field, enter or select the port number for the Clip Store server connection.

The default is **9595**.

## To configure Recall ID Options:

1. In the **Recall ID Options** section, select the **Allow same Recall ID to be used in different projects** checkbox to use the same recall ID of a clip throughout different projects.

If selected, the **On duplicate recall ID** drop-down will adjust to indicate (in same project).

When syncing between Clip Stores, all systems must have this option configured identically.

2. From the **On duplicate recall ID** drop-down, select an option for handling incoming clips with a duplicate recall ID:

- **remove recall ID from existing clip** — remove the recall ID from the clip already stored on the server.
- **delete existing clip when it has no subclips** — delete a duplicate clip from the server if it has had no subclips created from it.
- **delete existing clip and subclips** — delete a duplicate clip and its subclips from the server.

### To configure General Server Information:

1. In the **General Server Information** section, in the **Name** field, enter a name for the Clip Store server, if necessary.

The default name is **XPression Clip Store**.

2. In the **Location** field, enter the name of the location where the Clip Store server is located, if necessary.
3. In the **Description** field, enter a brief descriptor for the Clip Store server, if necessary.

### To configure the HTTP Server settings:

1. In the **HTTP Server** section, select the **Enable HTTP Server** checkbox to enable an HTTP server that provides a REST interface for retrieving clip information from the Clip Store.

2. In the **HTTP Port** field, enter or select the port number for the connection.

The default port is **9550**.

3. Select the **HTTPS / SSL** checkbox to use HTTPS / SSL.

This requires a pre-installed SSL certificate.

When **HTTPS / SSL** is enabled, the port number is fixed to **9444**.

4. Select **OK** to apply the Clip Store settings.

## Adding User Roles

Use the XPression Clip Store Manager to add user roles to allow and disable specific functions for specific roles that are assigned to users.

### To add a user role:

1. Connect to the XPression Clip Store Manager.
2. In the **Object Browser**, select **User Roles** from the Clip Store menu tree.

The **User Roles** section opens in the main window.

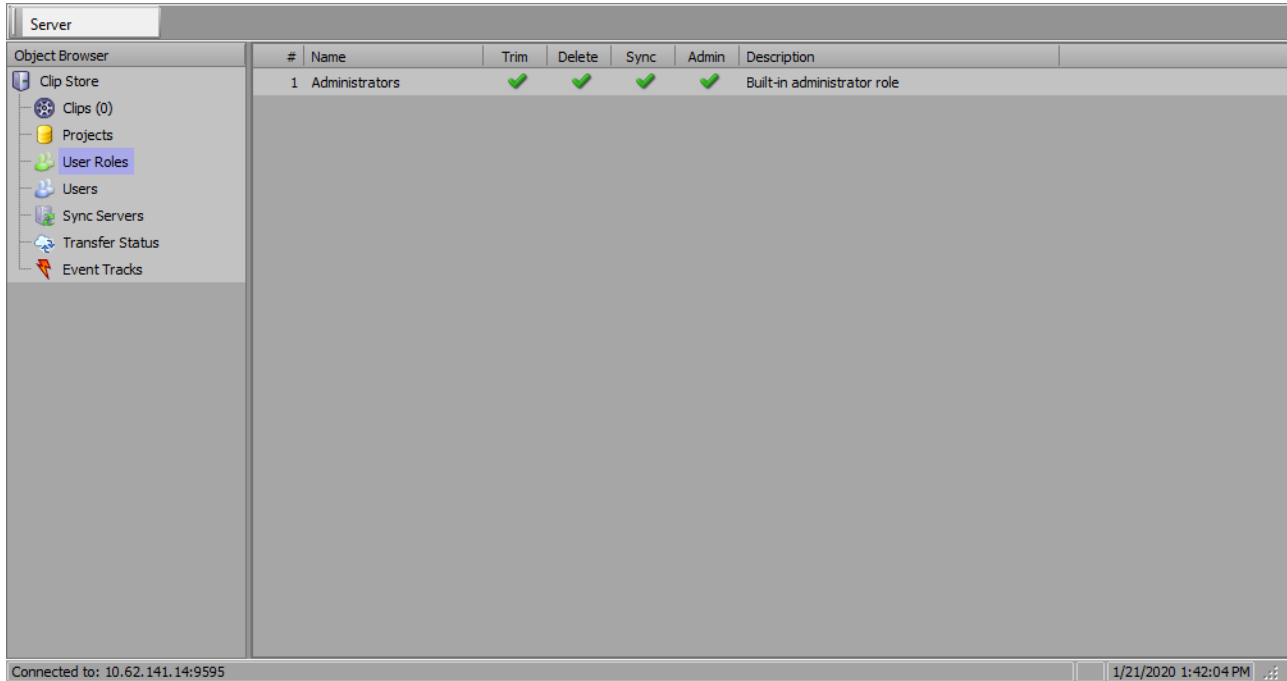

An **Administrator** role already exists by default.

3. Right-click inside the **User Roles** list and select **New** from the shortcut menu.

The **New User Role** dialog opens.

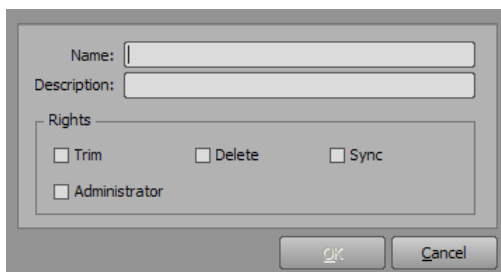

4. In the **New User Role** dialog, enter the following information:
  - **Name** — enter a name for the new user role. For example, if a user is being given deletion rights, a user role could be given the name 'Delete'.
  - **Description** — enter a brief descriptor for the user role, if necessary.

5. In the **Rights** section, use the checkboxes to select the rights allowed for the user role:

**Trim** — this feature will be available in a future release.

**Delete** — ability to delete clips.

**Sync** — ability to synchronize servers.

Sync users also require delete rights if deletes are to be synchronized across Clip Stores.

**Administrator** — ability to access all rights.

6. Select **OK**.

The new user role is added to the **User Roles** list.

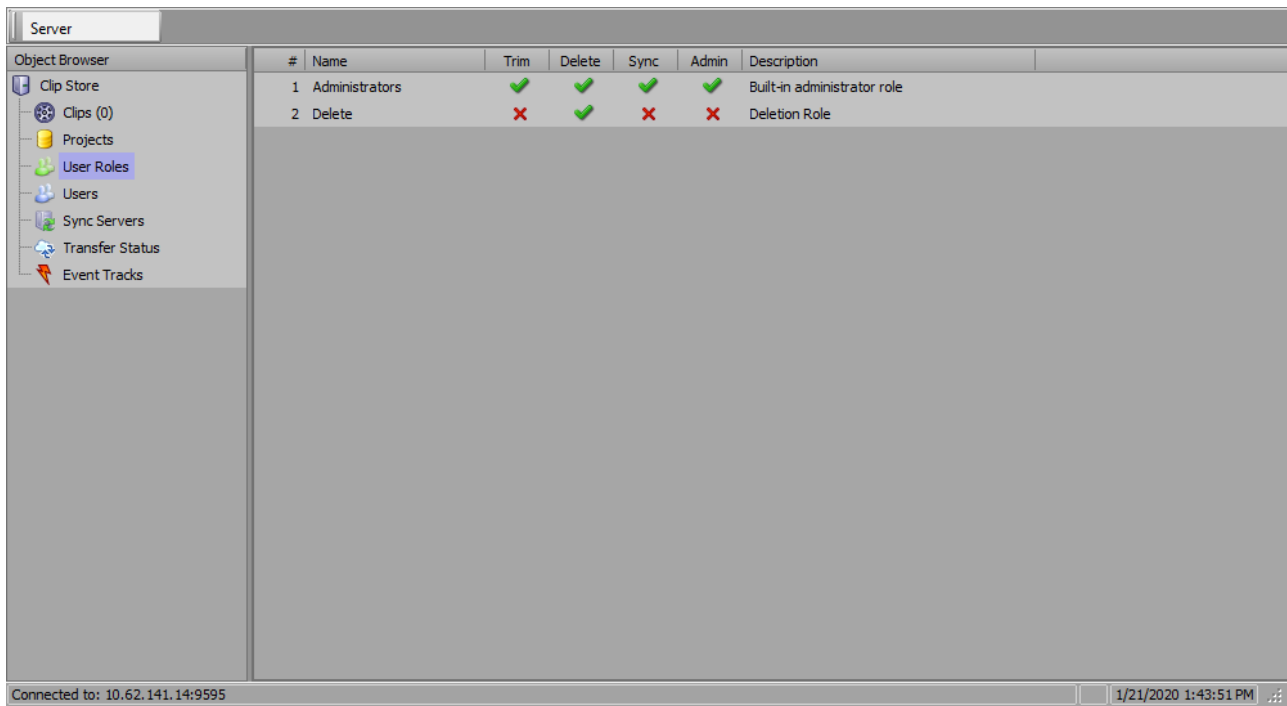

7. Repeat steps 3 to 6 for any other new roles.

# Adding Users

Use the XPression Clip Store Manager to add users and assign specific user roles that allow and disable specific functions.

### To add a user:

1. Connect to the XPression Clip Store Manager.
2. In the **Object Browser**, select **Users** from the Clip Store menu tree.

The **Users** section opens in the main window.

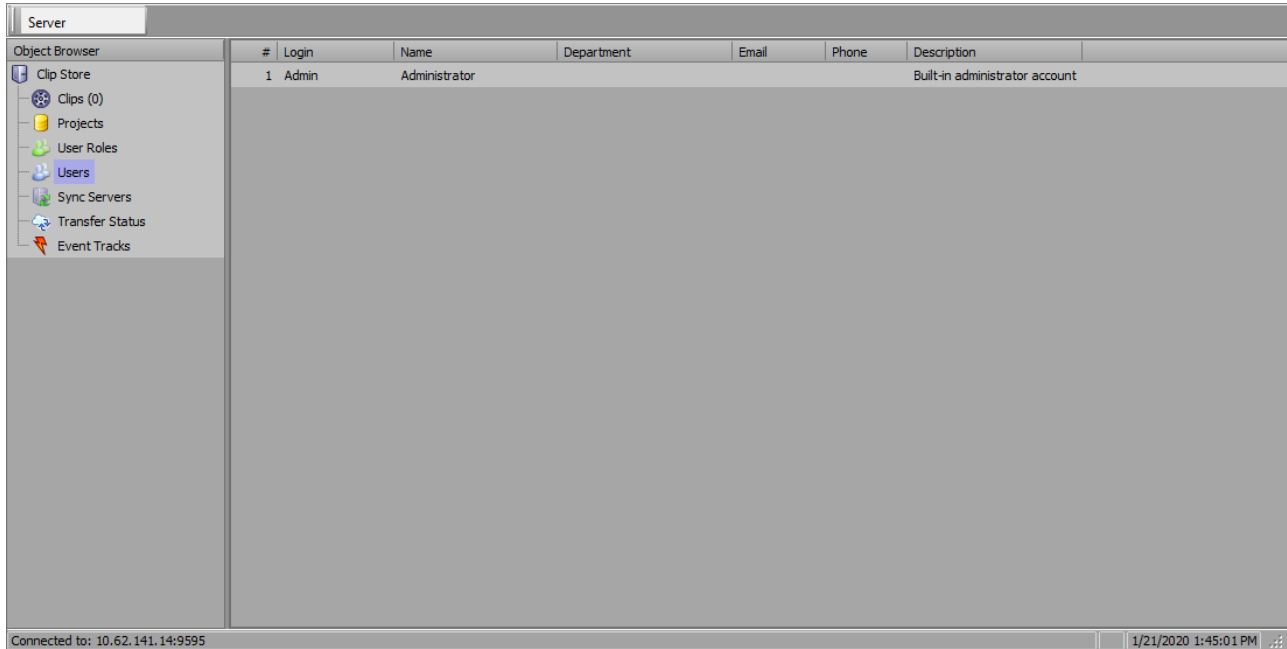

An **Admin** user already exists by default.

3. Right-click inside the **Users** list and select **New** from the shortcut menu.

The **New User** dialog opens.

The 'New User' dialog box has three tabs: 'User', 'Roles', and 'API'. The 'User' tab is active. It is divided into two sections: 'Credentials' and 'Information'. The 'Credentials' section contains three text input fields: 'Login:', 'Password:', and 'Verification:'. The 'Information' section contains five text input fields: 'Name:', 'Department:', 'Email:', 'Phone:', and 'Description:'. At the bottom right, there are 'OK' and 'Cancel' buttons.

4. In the **User** tab of the **New User** dialog, enter the following information:
  - In the **Credentials** section, in the **Login** field, enter a login credential for the new user.
  - In the **Password** field, enter a password for the new user.
  - In the **Verification** field, re-enter the password.
  - In the **Information** section, in the **Name** field, enter the name of the new user.  
A name must be entered to create a new user.
  - In the **Department** field, enter the name of the department of the new user, if necessary.
  - In the **Email** field, enter the email address of the new user, if necessary.
  - In the **Phone** field, enter the phone number of the new user, if necessary.
  - In the **Description** field, enter a brief descriptor for the user, if necessary.
5. Select **OK**.

The new user is added to the **Users** list.

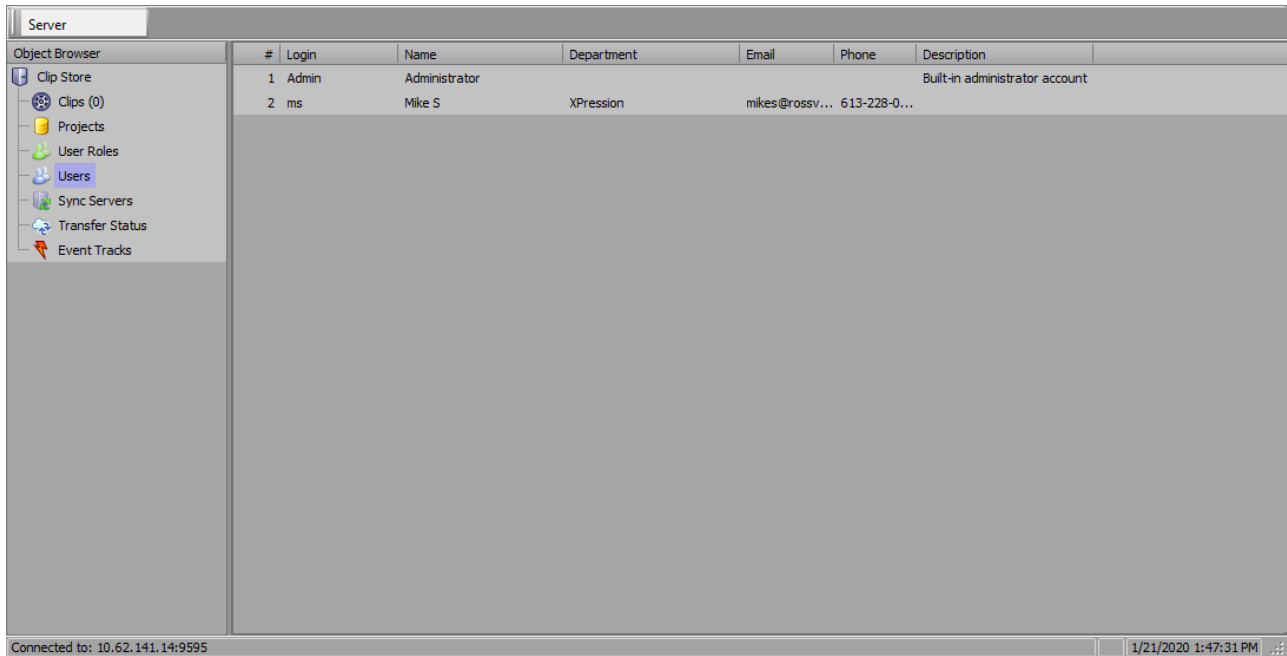

6. Repeat steps 3 to 5 to add more new users.

## To assign a role to a user:

1. Select the **Roles** tab.

The **Roles** tab opens.

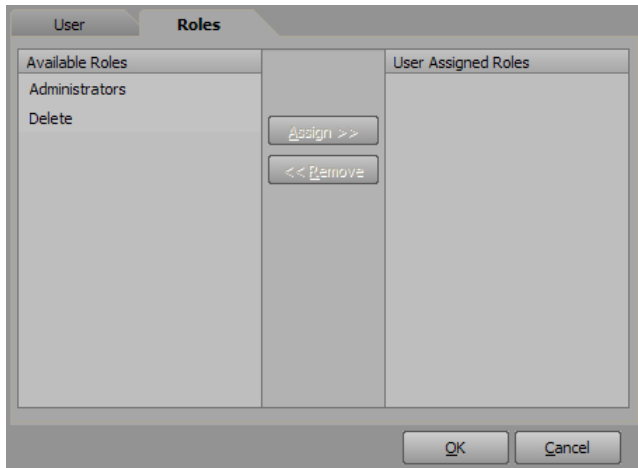

2. In the **Roles** tab, select a role in the **Available Roles** list.
3. Then select **Assign**.

The role is added to the **User Assigned Roles** list.

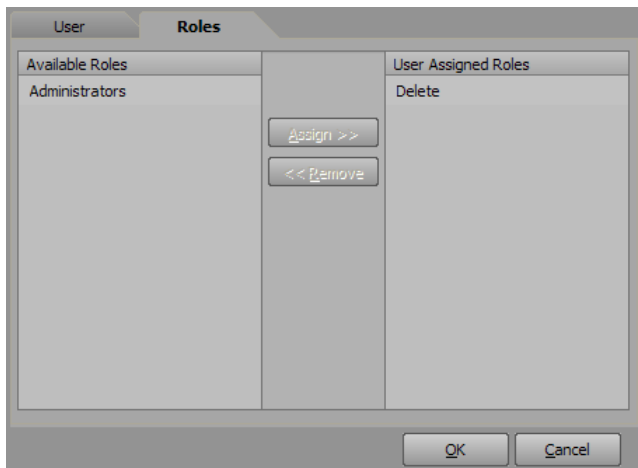

4. Repeat steps 2 and 3 for any other available roles, if necessary.
5. Select **OK**.

## For More Information on...

- adding user roles, refer to [Add User Roles](#).

# Synchronizing Multiple Clip Stores

Use the **Sync Servers** section to synchronize multiple Clip Stores. A sync server is a server that has clips pushed to it.

Synchronizing multiple Clip Stores will ensure that any changes and edits to a clip, or sub-clips created from a clip, will be reflected across all Clip Stores that have been synced.

## To synchronize multiple clip stores:

1. Connect to the XPression Clip Store Manager.
2. In the **Object Browser**, select **Sync Servers** from the Clip Store menu tree.

The **Sync Servers** section opens in the main window.

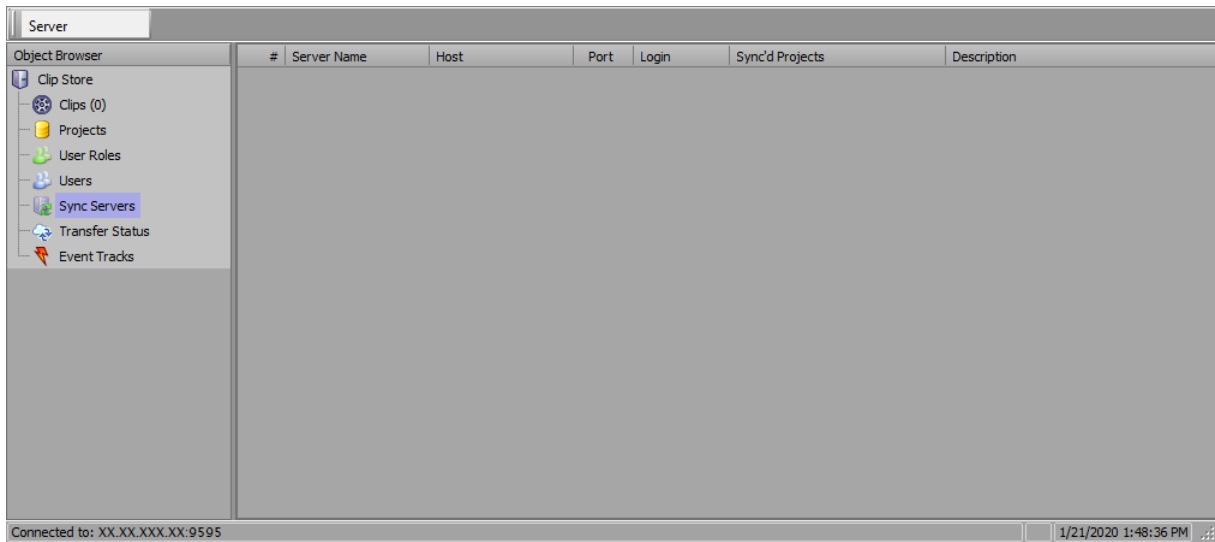

The **New Sync Server** dialog opens.

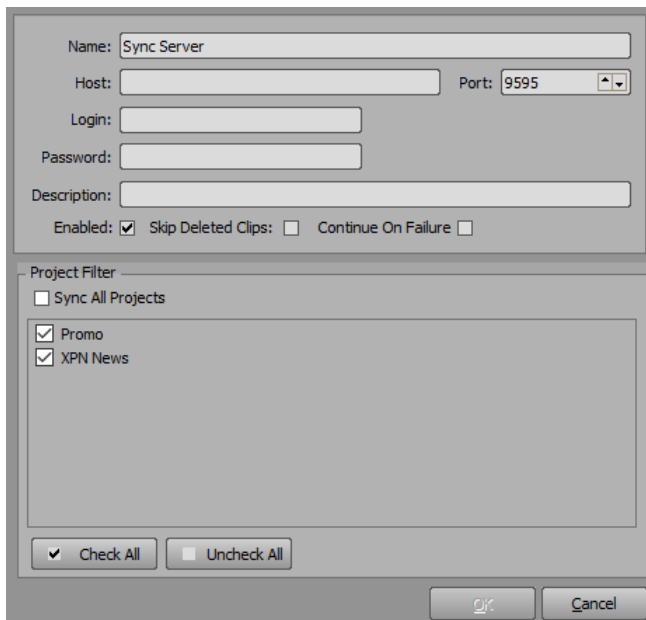

3. In the **New Sync Server** dialog, set up the server from which the clips will be synchronized:
  - **Name** — enter the name of the sync server. The default name is Sync Server.
  - **Host** — enter the IP address of the sync server.
  - **Port** — enter the port number of the sync server. The default is 9595.
  - **Login** — enter the login username for the sync server.
  - **Password** — enter the login password for the sync server.
  - **Description** — enter a brief descriptor for the sync server, if necessary.
  - **Enabled** — activate the individual sync server. This is enabled by default.
  - **Skip Deleted Clips** — skip deleted clips when synchronizing.
  - **Continue On Failure** — continue clip sync after a clip fails to sync.
4. In the **Project Filter** section, select the **Sync All Projects** checkbox to sync all projects to a destination Clip Store or de-select it to choose specific projects to sync to a destination Clip Store.  
It is selected by default.
5. Select the **Check All** button to select all projects in the project list. Select the **Uncheck All** button de-select all projects in the project list.
6. Select **OK**.

The **New Sync Server** dialog closes and the new sync server is added to the **Sync Servers** list.

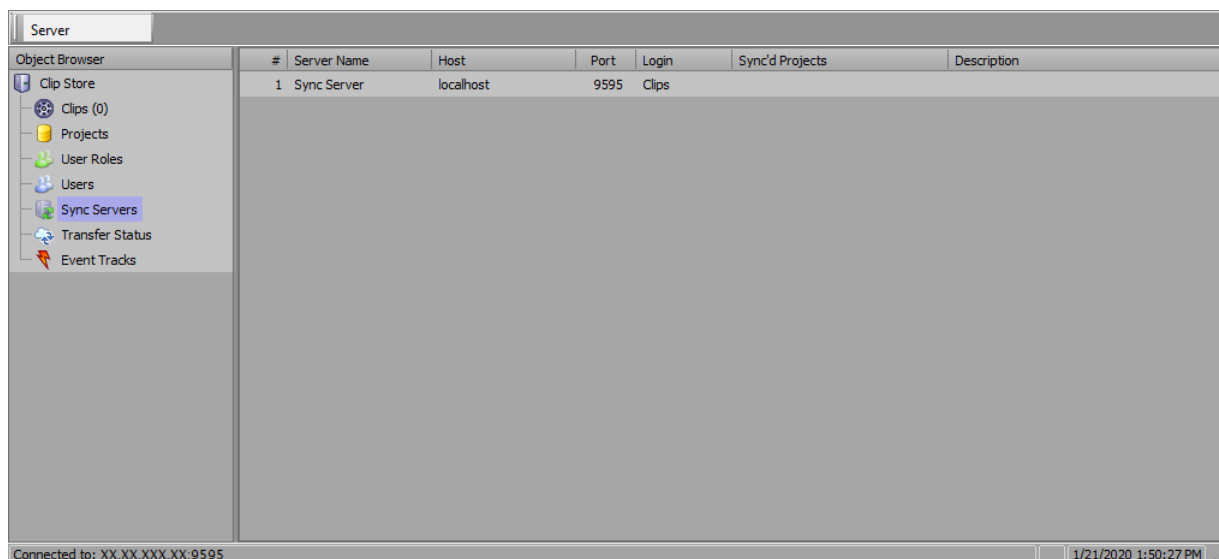

7. Repeat steps 3 to 6 to synchronize other servers, if necessary.

#### For More Information on...

- connecting to the XPression Clip Store server, refer to [Stating the Clip Store Manager](#).
- viewing the transfer status when syncing servers, refer to [Viewing the Transfer Status When Syncing Servers](#).

## Viewing the Transfer Status When Syncing Servers

Use the **Transfer Status** section to view the current progress when synchronizing Clip Stores.

Open it by selecting Transfer Status from the Clip Store menu tree in the **Object Browser**.

The transfer of files can take a while depending on the amount of files.

The following topics are discussed in this section:

[Receiving Files on a Synced Server](#)

[Outgoing Files from a Clips Server](#)

## Receiving Files On a Synced Server

When receiving files from a server, the **Receiving File** list will display the files as they are transferred:

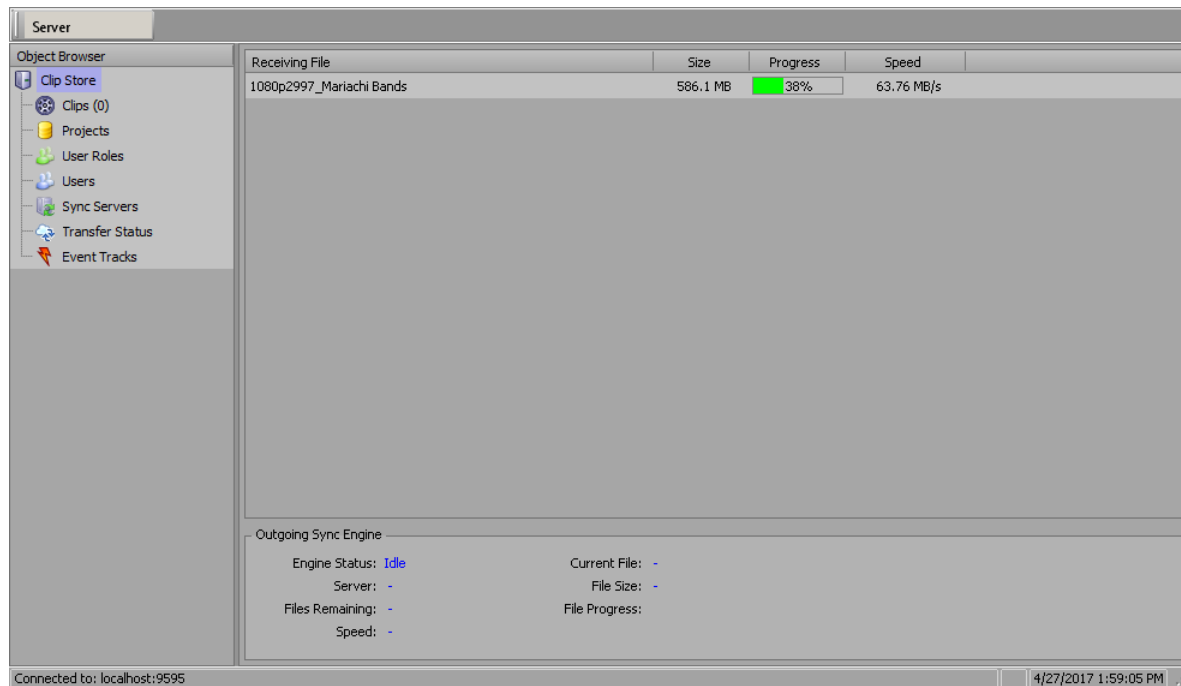

Only one file at a time is listed. The following file information is displayed:

- **Receiving File** (read-only) — displays the name of the file being received.
- **Size** (read-only) — displays the file size of the file being received.
- **Progress** (read-only) — displays a progress status bar and percentage completed for the file being received.
- **Speed** (read-only) — displays the speed of the download in MB/s.
- **Server** (read-only) — displays the IP address of files received.

During the incoming transfer, the **Outgoing Sync Engine** section will display the **Engine Status** as **Idle**.

## Outgoing Files from a Clips Server

When files are being pushed to a synced server, the **Outgoing Sync Engine** section displays the outgoing file transfer progress:

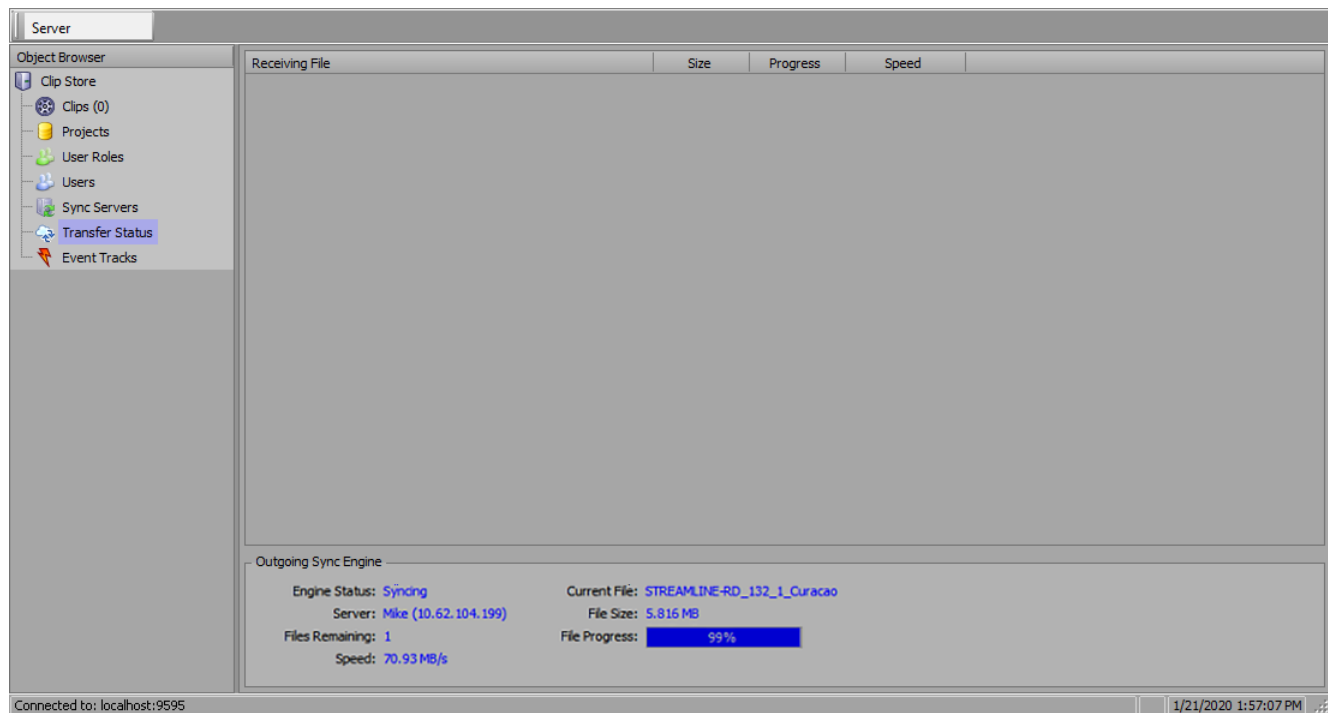

The following information is displayed:

- **Engine Status** (read-only) — displays the current status of the outgoing sync engine:
  - **Idle** — the outgoing sync engine is not currently processing any files.
  - **Syncing** — the outgoing sync engine is processing a file.
- **Server** (read-only) — displays the name and address of the server being synchronized.
- **Files Remaining** (read-only) — displays the remaining number of files to be synchronized.
- **Speed** (read-only) — displays the speed in MB/s of the file processing.
- **Current File** (read-only) — displays the name of the file being processed.
- **File Size** (read-only) — displays the size of the file being processed.
- **File Progress** (read-only) — displays a progress status bar and percentage completed for the file being processed.

# Browsing and Deleting Clips

Use the **Clips** section to browse and delete clips from the server. Use the **Clips** list to browse for specific clips, view the clip details, and delete clips from the server.

## To open the Clips section:

- In the **Object Browser**, select **Clips** from the Clip Store menu tree.

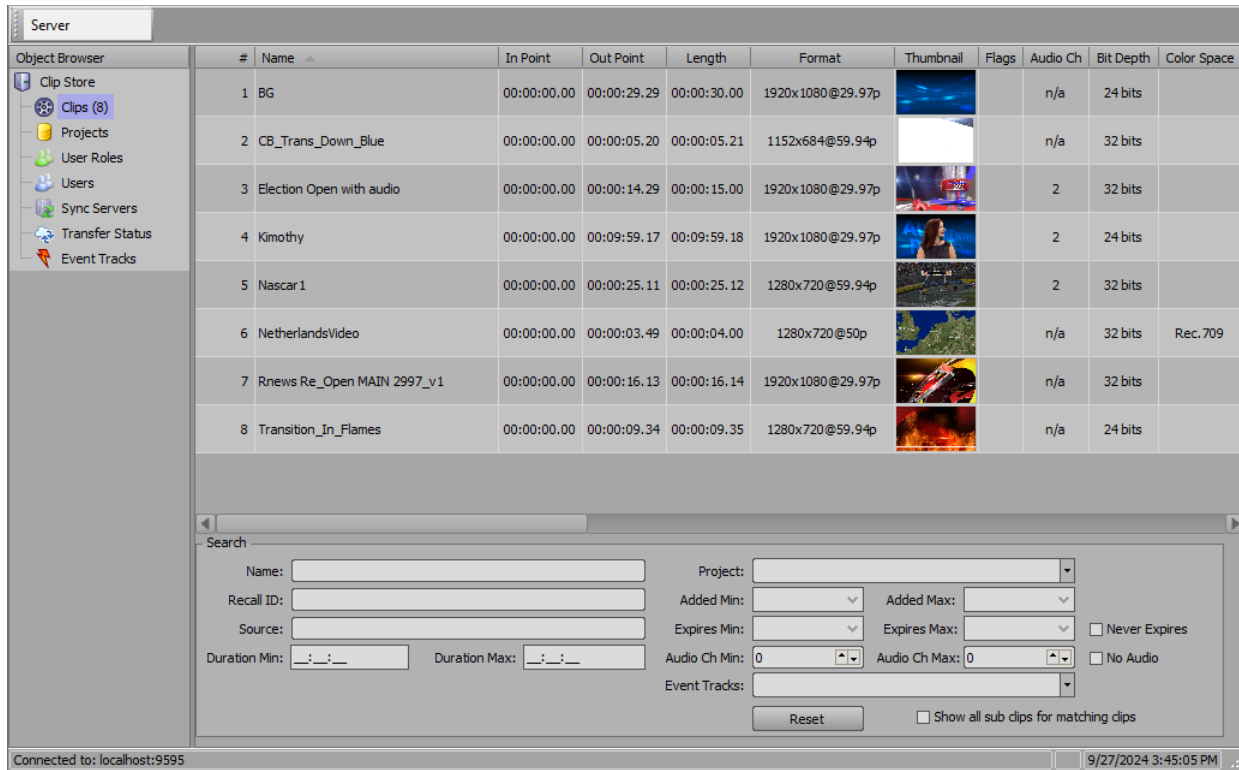

## To delete a clip:

- Right-click a clip and select **Delete** from the shortcut menu.

## Clips List

The following section describes the **Clips** list interface.

**#** (read-only) — list number in the Clip Browser list.

**Name** (read-only) — lists the name of the clip.

**In Point** (read-only) — lists the drop frame timecode starting point for the clip.

**Out Point** (read-only) — lists the drop frame timecode ending point for the clip.

**Length** (read-only) — lists the drop frame timecode duration of the clip.

**Format** (read-only) — lists the formatting used for the clip.

**Thumbnail** (read-only) — provides a thumbnail image of the clip or still. Thumbnails can be enlarged by selecting and dragging the right border of the thumbnail column title. Review a flip book playout of the clip by hovering the cursor over the thumbnail. The flip book is rendered over a checkerboard pattern so that the alpha channel is visible unless the clip is full frame. Still image thumbnails display an icon () indicating that they are still images and not clips.

**Flags** (read-only) — if using clips that have been transcoded by the XPression INcoder that include tags in the filename, this column lists the tags that have been parsed from the filename of the clip. The possible flags include:

- **LE** — indicates that looping has been enabled.
- **HF** — indicates that the clip will hold the last frame.
- **PM** — indicates that the clip uses premultiplied/shaped video.

**Audio Ch** (read-only) — lists the amount of audio channels embedded in the clip.

**Bit Depth** (read-only) — lists the quality of the signal quantization for the clip.

**Recall ID** (read-only) — lists the ID number for the clip when it is recalled.

**Project** (read-only) — lists the name of the project to which the clip has been added.

**Added** (read-only) — lists the date the clip was added to the project.

**Expires** (read-only) — lists the expiry date for the clip, if applicable.

**Codec** (read-only) — lists the codec format of the clip.

**File Ext** (read-only) — lists the file type of the clip.

**Source** (read-only) — lists the location on the server where the clips are stored.

**File Size** (read-only) — lists the file size of the clip in MB.

**Unique ID** (read-only) — lists the unique identification assigned to the clip when it was transcoded.

**Alpha** (read-only) — provides a thumbnail of the clip with the alpha channel visible (if the original status indicates <no info>, then re-ingest the original clip or update the thumbnail in the Edit Clip/Add Sub Clip dialog box).

**First Frame TC** (read-only) — lists the timecode at the point of the first frame of the clip.

**Volume** (read-only) — lists the volume level of the clip in decibels.

**Has Proxy** (read-only) — lists whether the clip includes a proxy or not.

## Search

The following section describes the **Search** interface of the Clips section.

**Name** — enter the name of a clip to search.

**Recall ID** — enter a recall ID to search.

**Source** — enter a location to search for a clip.

**Duration Min** — enter a minimum duration time to search for the clip.

**Duration Max** — enter a maximum duration time to search for the clip.

**Project** — select a project to search for the clip.

**Added Min** — use the calendar to select a minimum date to search that the clip was added.

**Added Max** — use the calendar to select a maximum date to search that the clip was added.

**Expires Min** — use the calendar to select the minimum expiry date to search for the clip.

**Expires Max** — use the calendar to select the maximum expiry date to search for the clip.

**Never Expires** — select this checkbox to search for a clip with no expiry date set.

**Audio Ch Min** — enter or select a minimum amount of embedded audio channels to search for the clip.

**Audio Ch Max** — enter or select a maximum amount of embedded audio channels to search for the clip.

**No Audio** — select this checkbox to search for a clip with no embedded audio.

**Reset** — clear all the fields in the Advanced Search Options.

**Show all sub clips for matching clips** — select to display any sub clips of a clip in the Clips list.

# Projects

Use the **Projects** section to create, edit, and delete projects.

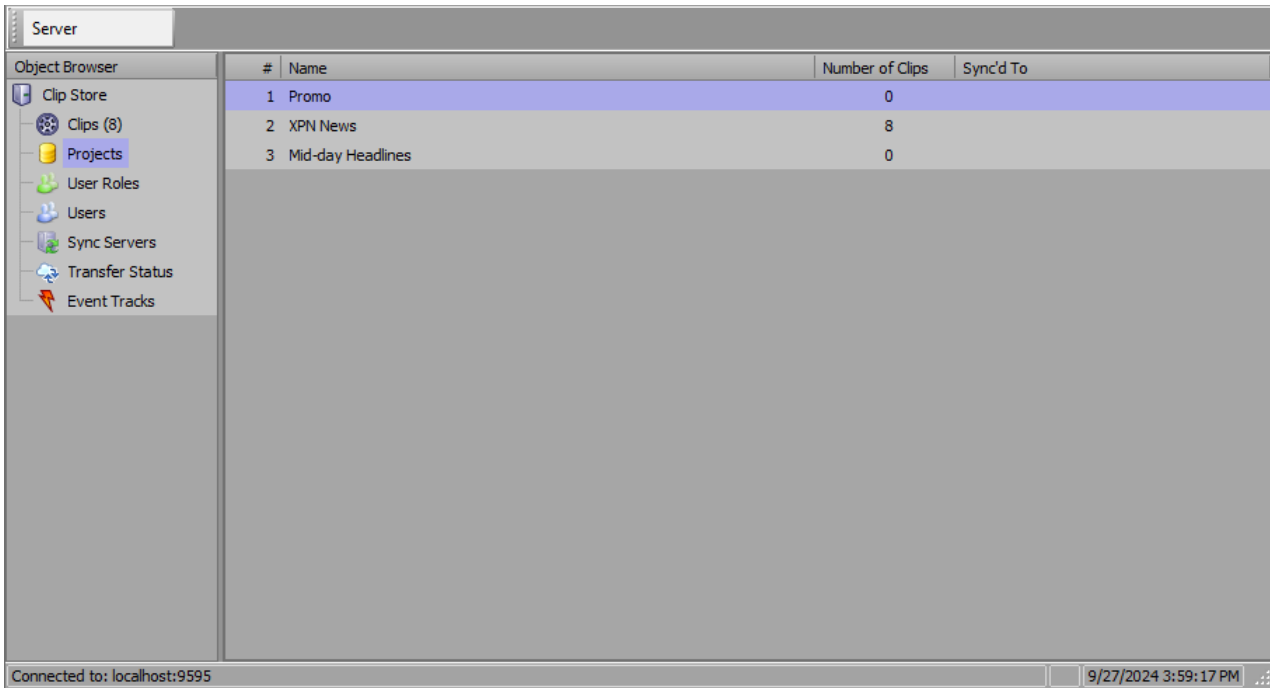

## To create a new project:

1. In the **Object Browser**, select **Projects** from the Clip Store menu tree.
2. Right-click inside the **Projects** list and select **New Project** from the shortcut menu.

The **New Project** dialog opens.

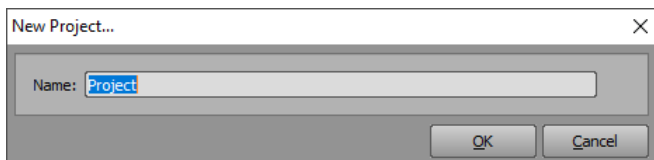

3. In the **Name** field, enter a name for the new project.
4. Select **OK**.

The new project is added to the **Projects** list.

## To edit a project:

1. Select a project in the **Projects** list.
2. Right-click and select **Edit Project** from the shortcut menu.
3. The **Edit Project** dialog opens.

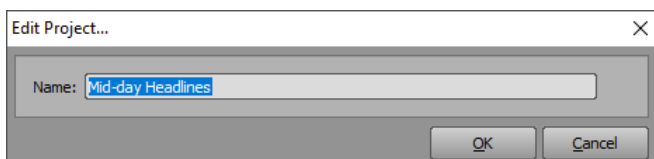

4. In the **Name** field, edit the name of the project.
5. Select **OK**.

The edited project name is updated in the **Projects** list.

#### To delete a project:

1. Select a project in the **Projects** list.
2. Right-click and select **Delete Project** from the shortcut menu.

A warning prompt opens.

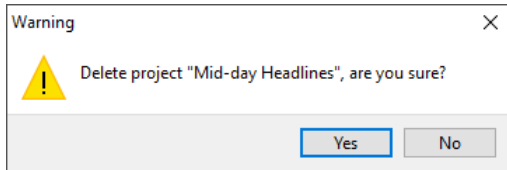

3. Select **Yes**.

The project is deleted from the **Projects** list.

## Projects List

The following section describes the **Projects** interface.

**#** (read-only) — list number in the Projects list.

**Name** (read-only) — lists the name of the project.

**Number of Clips** — displays the number of clips in the project.

## Wiping the Clips Database

If the clips database needs to be deleted, there is an option in the **Clip Store Manager** to permanently wipe the clips database.

### To permanently wipe the clips database:

1. Connect to the XPression Clip Store Manager.
2. Select **Server > Advanced > Wipe clips and database.**

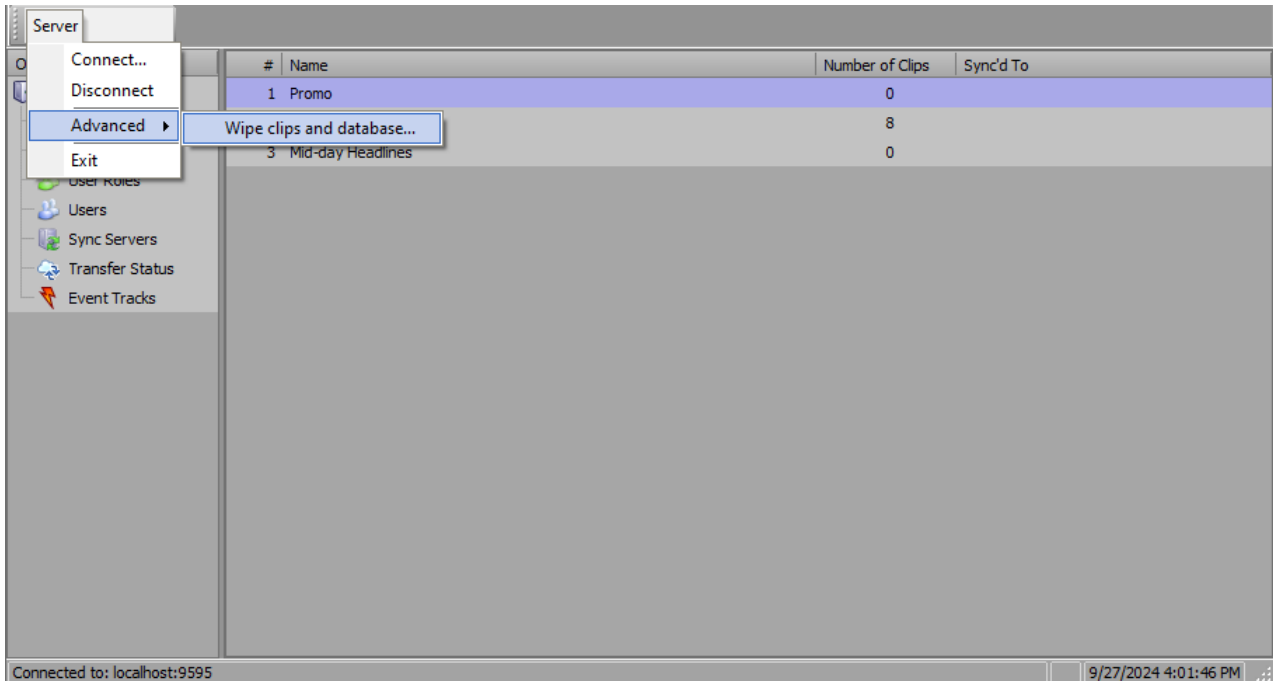

3. A confirmation dialog opens.

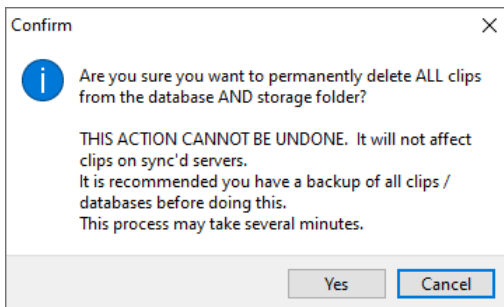

4. Select **Yes**.

A notification about the deletion opens.

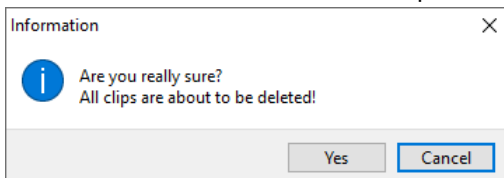

5. Select **Yes**.

The Clips database is wiped.

## Configuring XPression Studio, BlueBox, and Gateway for XPression Clip Store

Once XPression Clip Store has been configured using the Clip Store Manager, depending on the workflow, the following need to be set up for use with the Clip Store:

[XPression Studio](#)

[XPression BlueBox](#)

[XPression Gateway](#)

## XPression Studio

### To set up XPression Studio for use with the Clip Store:

1. Open XPression.
2. In XPression, select **Edit > Clip Store Setup**.

The **Clip Store Setup** dialog opens.

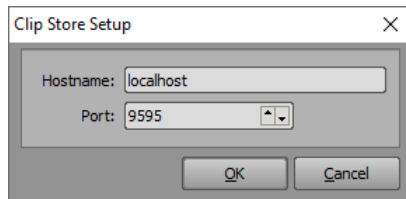

3. In the **Hostname** field, enter the IP address of the Clip Store service if using remotely.

#### **OR**

If using the Clip Store service locally, use **localhost** (default).

4. In the **Port** field, enter or select the port number for the Clip Store server connection.

The default is **9595**.

5. Select **OK**.

XPression Studio is now connected to the Clip Store service.

## XPression BlueBox

### To set up XPression BlueBox for use with the Clip Store:

1. Start the XPression BlueBox Service if not already started.
2. In the Windows toolbar, right-click the XPression BlueBox icon () and select **Clip Store Setup** from the menu.

The **Clip Store Setup** dialog opens.

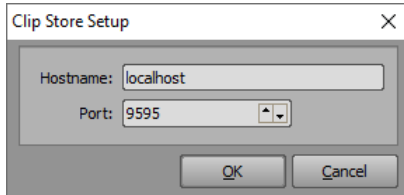

3. In the **Hostname** field, enter the IP address of the Clip Store service if using remotely.

#### **OR**

If using the Clip Store service locally, use **localhost** (default).

4. In the **Port** field, enter or select the port number for the Clip Store server connection.

The default is **9595**.

5. Select **OK**.

XPression BlueBox is now connected to the Clip Store service.

## XPression Gateway

With a Clip Store configured on the XPression Gateway, the XPression MOS Plugin offers the ability to browse, preview, and select clips as MOS items to include in an NRCS running order. It integrates with the XPression output and preview engines and the Remote Sequencer.

### To set up the XPression Gateway for use with the Clip Store:

1. Open the XPression Gateway.
2. In the XPression Gateway, select **Gateway > Settings**.

The **XPression Gateway - Settings** dialog opens.

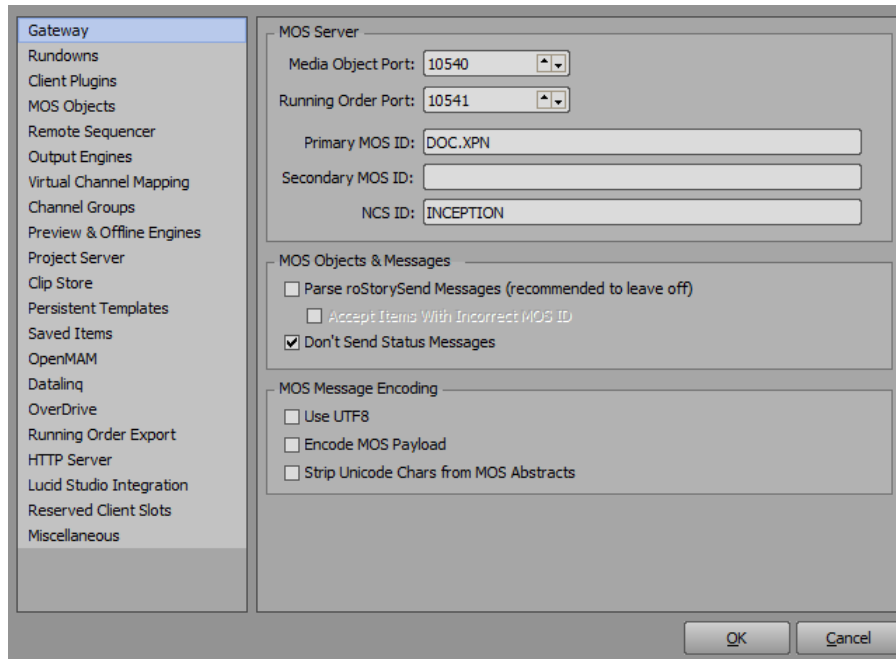

3. Select **Clip Store** to configure the Clip Store Server and settings to use XPression Clips in the MOS workflow.

The **Clip Store** configuration area opens.

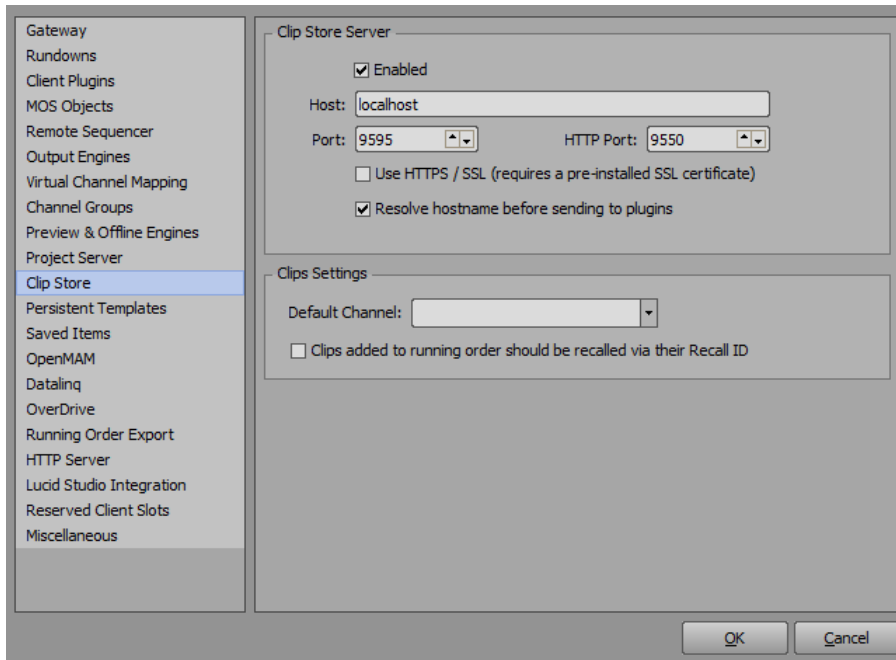

4. In the **Clip Store Server** section, select the **Enabled** checkbox to use the **Clip Store Server** in the MOS workflow.
5. In the **Host** field, enter the IP address of the Clip Store Server.
6. In the **Port** field, enter or select the port number for the Clip Store Server.
7. Select the **Use HTTPS / SSL** checkbox to enable the use of HTTPS/SSL in the HTTP Server configuration.  
Selecting this option requires a pre-installed SSL certificate.
8. Select the **Resolve hostname before sending to plugins** checkbox to resolve the ClipStore hostname to an IP before being provided to the client plugins.
9. In the **Clips Settings** section, from the **Default Channel** drop-down, select the default engine and channel to which the clips will be assigned.
10. Select the **Clips added to running order should be recalled via their Recall ID** to recall clips by their **Recall ID** rather than their name.

# XPression Media Control Gateway

The XPression Media Control Gateway can be used for cueing and playback of clips and subclips from a Clip Store and for cueing and playback of take items from the XPression Sequencer.

The AMP/VDCP channels correspond to the server channels in XPression. The format for the naming of the clips/take items can be configured in the **XPression Media Control Gateway - Settings** dialog. This format must ensure that every item is uniquely identified – duplicates will not be reported in the list of items retrieved by the remote device.

Clip and subclip formats support the following tags:

- %NAME%
- %FILENAME%
- %ID%
- %GUID%

The take item format supports the %ID% tag. Widths can be specified with a colon. For example %NAME:35% to limit the name to 35 characters, or %ID:4% to use a 4-digit ID padded with 0s.

VDCP/AMP support basic item cueing, as well as cueing with specific in and out points. Playback support includes jog, shuttle, and variable speed playback. VDCP/AMP also support recording of clips, which will be directly added to the XPression Clip Store upon a successful record.

The AMP protocol also supports retrieving thumbnails of the clips (when supported by the remote device).

★ Deleting and renaming items in the Clip Store or the XPression Sequencer is not supported by the gateway.

This section contains the following topics:

[Media Control Gateway Interface Overview](#)

[Opening the XPression Media Control Gateway Settings](#)

[Configuring the General Settings](#)

[Configuring the AMP Settings](#)

[Supported AMP Commands](#)

[Configuring the VDCP Settings](#)

[Supported VDCP Commands](#)

# Media Control Gateway Interface Overview

The following screen capture displays the main elements of the Media Control Gateway interface.



1. **File Menu** — use this list to access the Media Control Gateway settings or shutdown the gateway.
2. **Log** — displays the activity of the Media Control Gateway.
3. **Connections** — displays the connections and their respective status.

# Opening the XPression Media Control Gateway Settings

## To open the XPression Media Control Gateway Settings:

1. Launch the XPression Media Control Gateway.

The XPression Media Control Gateway opens.

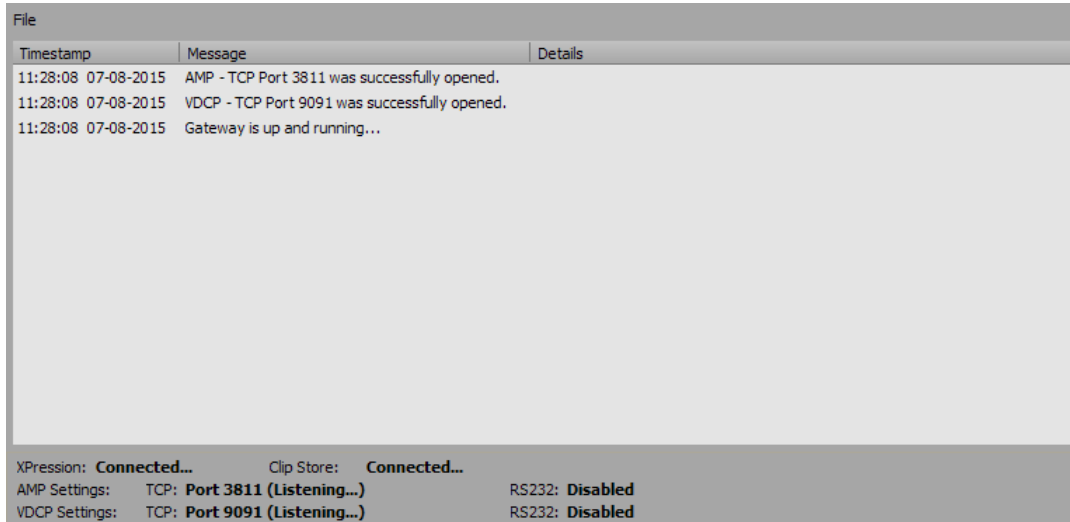

2. Select **File > Settings**.

The **XPression Media Control Gateway - Settings** dialog opens.

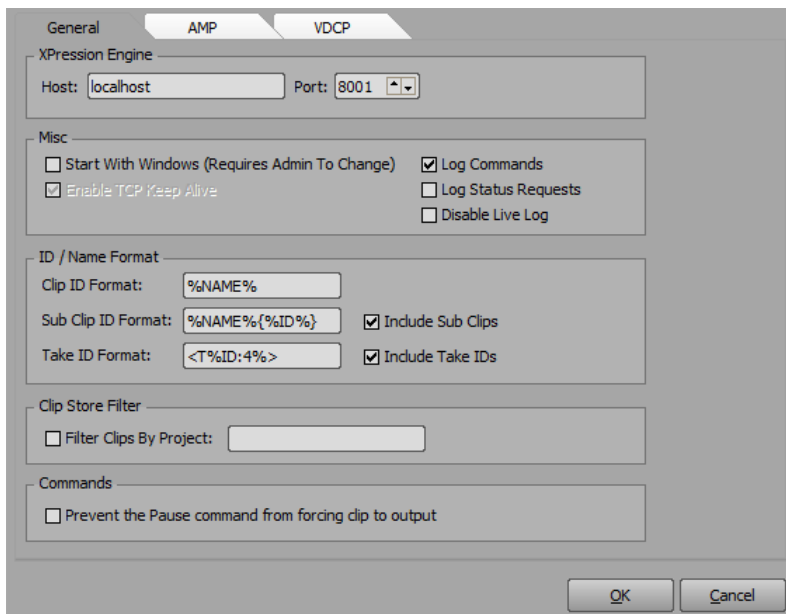

# Configuring the General Settings

To configure the General settings:

1. In the XPression Media Control Gateway, select **File > Settings**.

The **XPression Media Control Gateway - Settings** dialog opens.

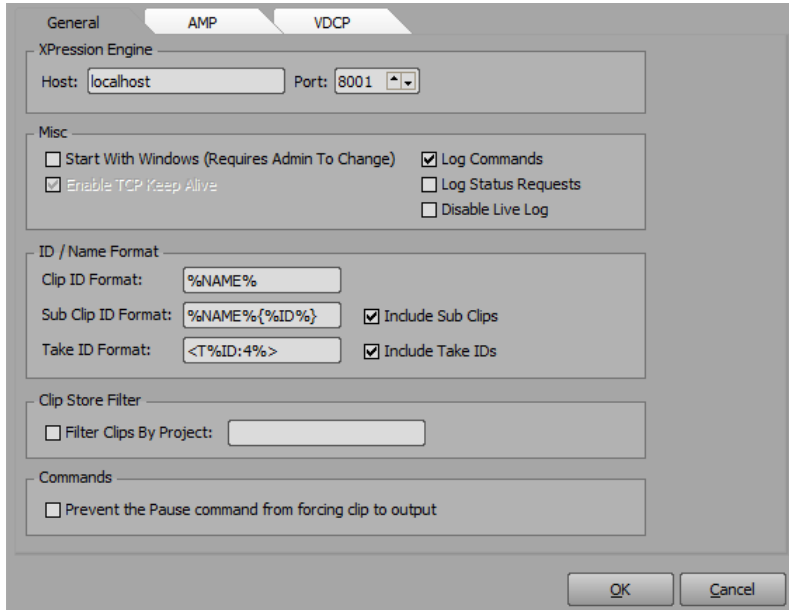

2. In the **General** tab, in the **XPression Engine** section, configure the following settings:
  - In the **Host** field, enter the IP address of the XPression machine to which the gateway is to connect.  
**OR**
  - Enter **localhost** to connect the gateway to the local XPression machine.  
The default setting is **localhost**.
  - In the **Port** field, enter or select the port number of the XPression machine.  
The default port number is **8001**.
3. In the **Misc** section, make the following selections as necessary:
  - **Start With Windows** — select to start the gateway when Windows launches.
  - **Log Commands** — select to log the commands in the gateway.
  - **Enable TCP Keep Alive** — select to prevent the TCP connection from breaking during periods of inactivity.
  - **Log Status Requests** — select to log the status requests in the gateway.
  - **Disable Live Log** — select to prevent logs being sent to the **Live Log**.

4. In the **ID / Name Format** section, do the following:

- In the **Clip ID Format** field, enter the format for the naming of the clips in the gateway.
- In the **Sub Clip ID Format** field, enter the format for the naming of the subclips in the gateway.
- Select the **Include Sub Clips** checkbox to include subclips in the clip list.

This is enabled by default.

- In the **Take ID Format** field, enter the format for the naming of take IDs in the gateway.
- Select the **Include Take IDs** checkbox to include take IDs from the XPression sequencer in the clip list.

This is enabled by default.

5. In the **Clip Store Filter** section, select the **Filter Clips By Project** checkbox to only retrieve clips from a specified project.

Enter a project name in the text field from which to retrieve clips.

6. In the **Commands** section, select the **Prevent the Pause command from forcing clip to output** checkbox to prevent the clip from going to output when pause commands are received from a device.

When this checkbox is selected, the **Cue video clips directly to framebuffer** checkbox in the **Options** tab of the **Server Channels** must not be selected for this preference to function.

7. Select **OK**.

The **XPression Media Control Gateway - Settings** dialog closes.

# Configuring the AMP Settings

To configure the AMP settings:

1. In the XPression Media Control Gateway, select **File > Settings**.

The **XPression Media Control Gateway - Settings** dialog opens.

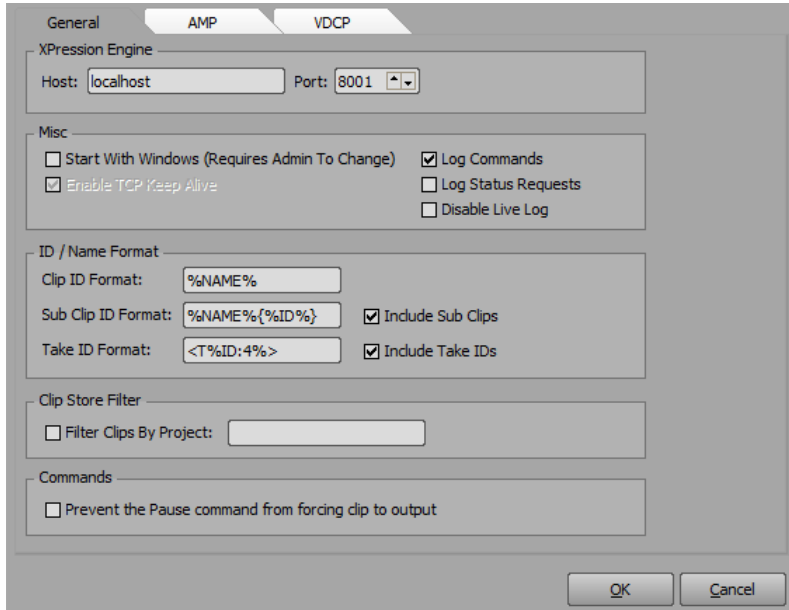

2. Select the **AMP** tab.

The **AMP** tab opens.

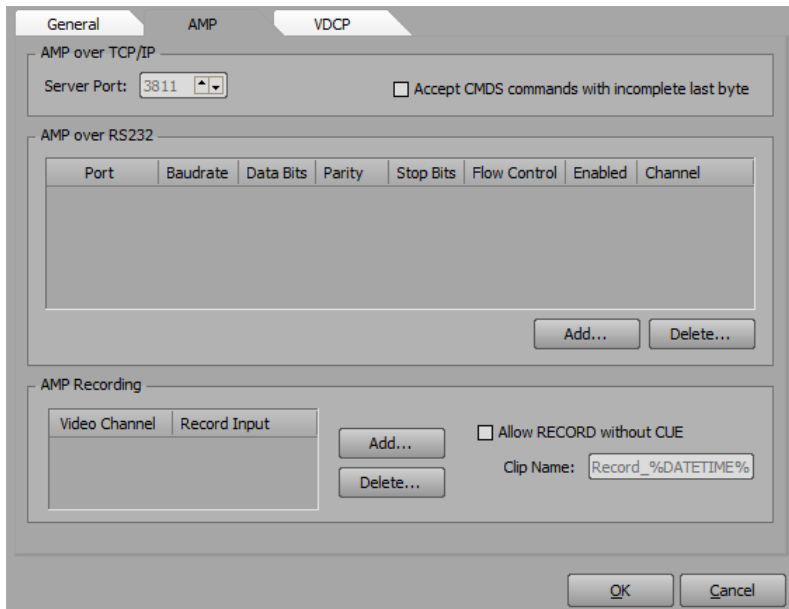

3. Configure the **AMP** connection settings as required:

#### AMP Over TCP/IP

- In the **AMP over TCP/IP** section, the **Server Port** field displays the port number for the TCP/IP server connection.

The default is **3811** and is not user-configurable.

- Select the **Accept AMP CMDS commands with incomplete last byte** to accept CMDS commands with an incomplete last ASCII byte.

**OR**

#### AMP Over RS232

- In the **AMP over RS232** section, select **Add** to add a port for the RS232 connection.

The **Select RS232 Port** dialog opens.

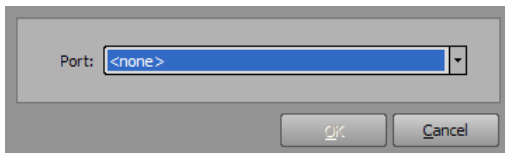

- From the **Port** drop-down, select a COM port for the connection and select **OK**.

The COM port is added to the AMP over RS232 connections list.

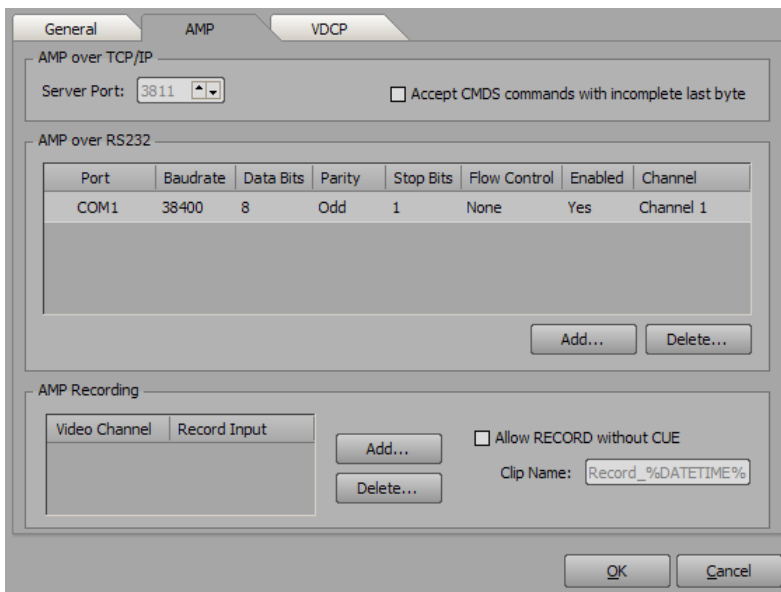

- Configure the connection settings if necessary:
  - **Port** — select a different COM port if necessary.
  - **Baudrate** — select a communication speed for GPI signals.
  - **Data Bits** — select the number of bits used to represent one character of data for GPI signals.
  - **Parity** — select the method used to check for lost data in a GPI signal.
  - **Stop Bits** — select the number of bits used to indicate the end of a byte in a GPI signal.
  - **Flow Control** — select the data transmission rate controller for a GPI signal.

- **Enabled** — select whether the AMP over RS232 connection is enabled or not.
- **Channel** — from the drop-down, select a server channel for playout.

When using TCP/IP, the channel corresponding to the server channel in XPression is specified by the remote device when establishing a connection. However, when using RS232, there is no such provision in the protocol, so the server channel needs to be specified.

4. In the **AMP Recording** section, select **Add** to select a source input if using AMP recording with the Record Client.

The **Select Video Channel #** dialog box opens.

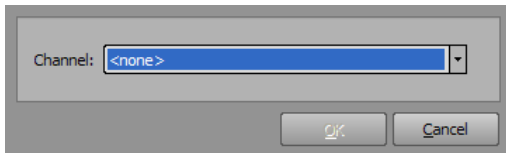

5. From the **Channel** drop-down, select a server channel to use for the AMP session and select **OK**.

The server channel is added to the **AMP Recording** list.

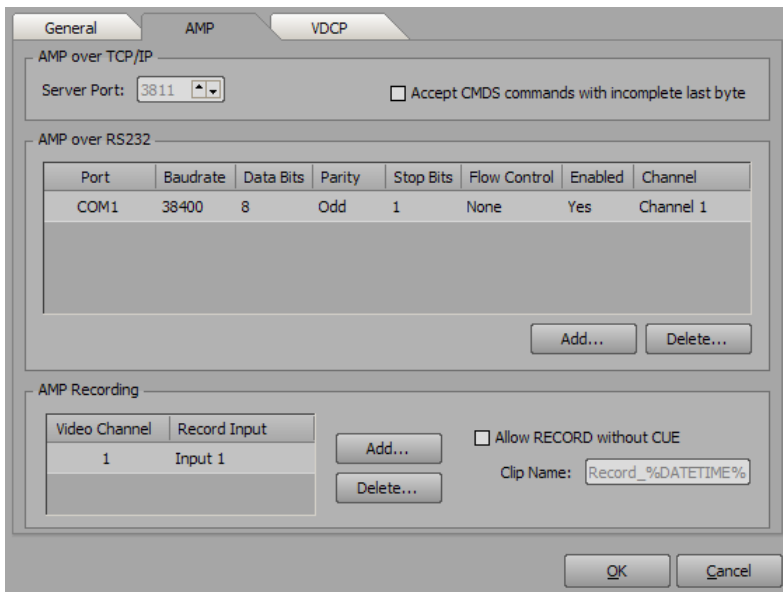

6. Select in the **Record Input** column and from the drop-down, select an input for recording functionality.

The default is **Input 1**.

When the AMP connection is configured to control a certain server channel, if this channel is associated with an input, then the AMP session will have playback control on the server channel and record control on the input. If the channel is not mapped to an input, then the AMP session will only have playback control.

Successful recordings are automatically added to the Clip Store.

7. Select the **Allow RECORD without CUE** checkbox to crash record from AMP when the RECORD command is received without the CUE command.
8. In the **Clip Name** field, enter the name of the clip to crash record using the RECORD without CUE function.
9. Select **OK**.

The **XPression Media Control Gateway - Settings** dialog closes.

## Supported AMP Commands

Cueing and playback control on output ports of clips in Clip Store and take items in the Sequencer is supported, as well as recording on input ports. Clip management, such as renaming, deleting, or modifying clips, is not supported. Delayed commands are also not supported. The option to send a list of clips to certain commands (e.g. IN PRESET) is not supported.

The following AMP commands are supported by the XPression Media Control Gateway:

STOP

PLAY

RECORD

EJECT

FAST FORWARD

JOG FORWARD/REVERSE

VARIABLE FORWARD/REVERSE

SHUTTLE FORWARD/REVERSE

REWIND

CUE UP WITH DATA

IN PRESET

OUT PRESET

STATUS SENSE

CURRENT TIME SENSE

RECORD CUE UP WITH DATA

GET THUMBNAIL

LIST FIRST ID

LIST NEXT ID

ID LOADED REQUEST

ID DURATION REQUEST

SET RECORD DURATION

ID START TIME REQUEST

ID COUNT REQUEST

DEVICE NAME REQUEST

# Configuring the VDCP Settings

To configure the VDCP settings:

1. In the XPression Media Control Gateway, select **File > Settings**.

The **XPression Media Control Gateway - Settings** dialog opens.

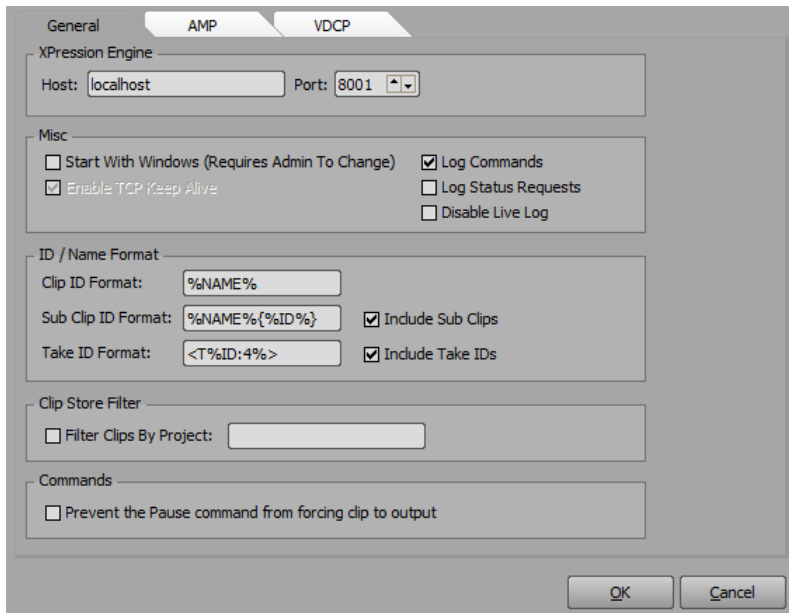

2. Select the **VDCP** tab.

The **VDCP** tab opens.

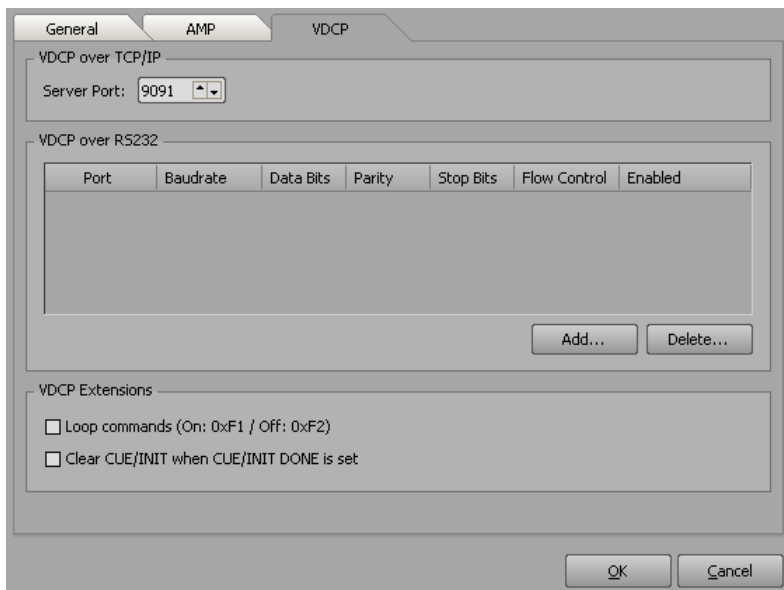

3. Configure the **VDCP** connection settings as required:

**VDCP Over TCP/IP**

- In the **VDCP over TCP/IP** section, in the **Server Port** field, enter or select the port number for the TCP/IP server connection.

The default is **9091**.

**OR**

**VDCP Over RS232**

- In the **VDCP over RS232** section, select **Add** to add a port for the RS232 connection.

The **Select RS232 Port** dialog opens.

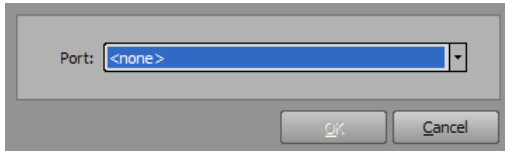

- From the **Port** drop-down, select a COM port for the connection.
- Select **OK**.

The COM port is added to the VDCP over RS232 connections list.

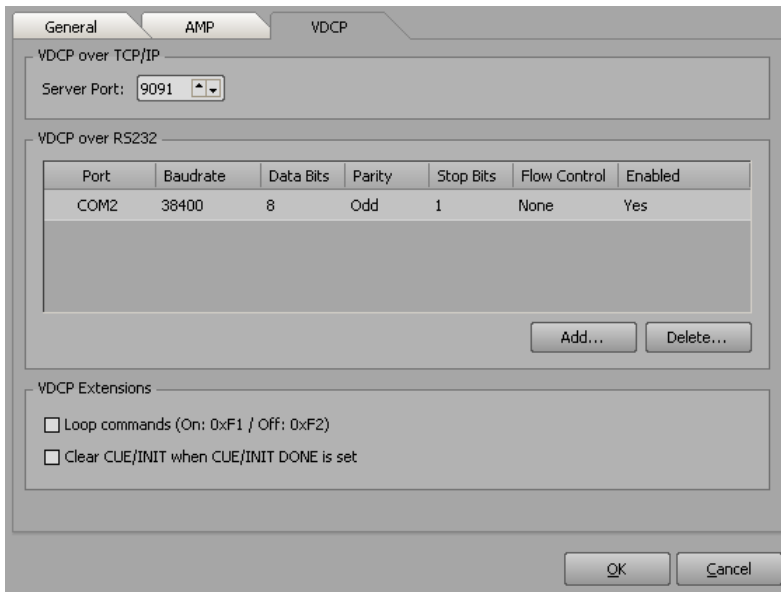

- Configure the connection settings as necessary:
  - **Port** — select a different COM port if necessary.
  - **Baudrate** — select a communication speed for GPI signals.
  - **Data Bits** — select the number of bits used to represent one character of data for GPI signals.
  - **Parity** — select the method used to check for lost data in a GPI signal.
  - **Stop Bits** — select the number of bits used to indicate the end of a byte in a GPI signal.
  - **Flow Control** — select the data transmission rate controller for a GPI signal.
  - **Enabled** — select whether the VDCP over RS232 connection is enabled or not.

4. Select the **Loop commands** checkbox to use a VDCP extension to turn looping on (0x1X 0xF1) and off (0x1X 0xF2).

This option is disabled by default.

5. Select the **CUE/INIT when CUE/INIT DONE is set** checkbox to only if the VDCP controller does not support having both the CUE/INIT and CUE/INIT DONE flags asserted simultaneously (playback or record).

This option is disabled by default.

6. Select **OK**.

The **XPression Media Control Gateway - Settings** dialog closes.

## Supported VDCP Commands

Cueing and playback control on output ports of clips in Clip Store and take items in the Sequencer is supported, as well as recording on input ports. Clip management, such as renaming, deleting, or modifying clips, is not supported. Also, timeline and macro commands are not supported.

The following VDCP commands are supported by the XPression Media Control Gateway:

### Immediate commands:

STOP  
PLAY  
RECORD  
STILL  
CONTINUE  
STEP  
JOG  
VAR PLAY

### Preset commands:

CLOSE PORT  
SELECT PORT  
PLAY CUE  
PLAY CUE WITH DATA  
RECORD INIT

### Sense commands:

PORT STATUS  
OPEN PORT  
ID LIST  
ID ADDED LIST  
ID DELETED LIST  
NEXT  
ACTIVE ID REQUEST  
POSITION REQUEST  
ID SIZE REQUEST  
ID REQUEST  
DEVICE TYPE REQUEST

# XPression INcoder

The XPression INcoder is a separate, optional component to the XPression Clips workflow. If the INcoder has not been purchased, use the Record Client feature in XPression to transcode clips. For more information, or to purchase the INcoder, contact Ross Video.

The following topics are discussed in this section:

[XPression INcoder Overview](#)

[INcoder User Interface Overview](#)

[Configuring the XPression INcoder](#)

[XPression INcoder Tasks](#)



## XPression INcoder Overview

The XPression INcoder is a windows service that manages one or more watchfolders used for file based ingest of clips into the XPression Clips workflow. The INcoder performs transcoding functions to convert clips from compatible formats into XPression Codec AVI files. The same formats supported by the XPression Video Coder can be transcoded by the INcoder. Still images can be exported to the Clip Store in their native format.

After clips have been dropped into a watchfolder, an email based notification system can alert configured users to status events such as failures or successful transcodings.

The XPression INcoder Manager is used for managing and configuring the INcoder service. The INcoder Manager can run on the INcoder machine or connect to a remote INcoder.

### INcoder Terminology

There are several pieces of terminology to understand in the INcoder Manager necessary for configuring it.

**Source** — a source represents a watchfolder where clips can be placed to be transcoded. The watchfolder can exist on a local or accessible network drive.

**Project** — an abstract concept used for grouping clips. A watchfolder should be assigned a project. Examples of projects could be: news, sports, weather, etc. Separate watchfolders could be assigned for each project so that clips dropped into a particular folder on disk will be assigned the correct project which can later be used for searching or clerical tasks. Each project can have separate lists of users to notify.

**Target** — a target represents the destination to which the transcoded clip should be sent. In the case of XPression Clips, the target would be an XPression Clip Store. After a successful transcode the clip will be sent to all of the targets assigned to the processor.

**Processor** — a processor represents a collection of targets. Each source (watchfolder) must be assigned a processor. After transcoding, all targets in the processor will receive the final clip.

#### For More Information on...

- the XPression INcoder, refer to the *XPression INcoder User Guide*.

# INcoder User Interface Overview

This section provides a user interface overview for the XPression INcoder Manager interface.

The following user interfaces are discussed in this section:

[The XPression INcoder - Tasks Tab](#)

[The XPression INcoder - Configuration Tab](#)

## The XPression INcoder - Tasks Tab

The following screen capture displays the main elements of the **Tasks** tab in the **XPression INcoder Manager**.

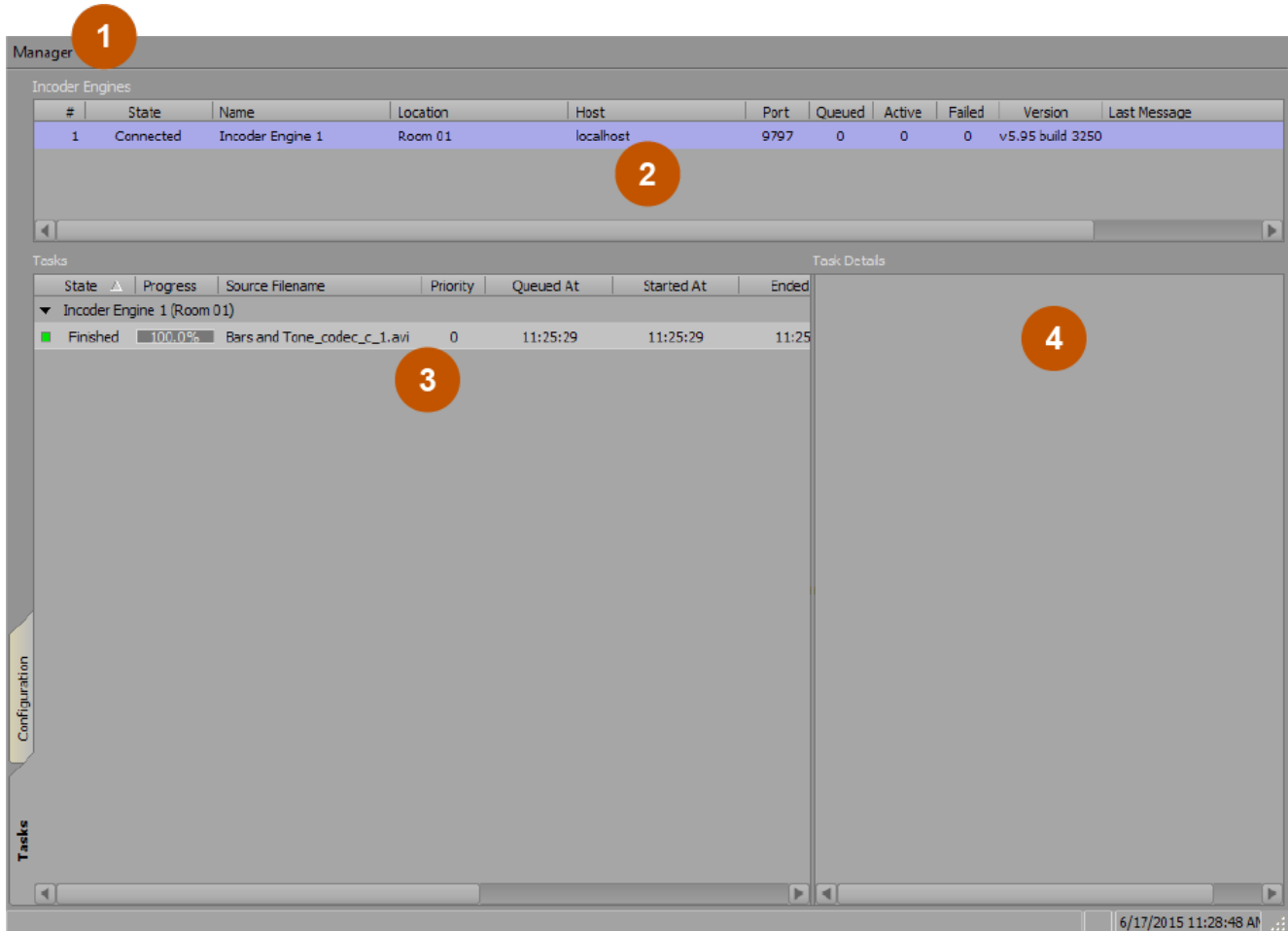

- 1) **Menu Bar** — use the **Manager** menu to exit XPression INcoder.
- 2) **INcoder Engines** — view the configured engines for XPression INcoder along with their state and details.
- 3) **Tasks** — view the list of clips that are transcoded and transcoding for specific INcoder engines, as well as the details about the transcoding.
- 4) **Task Details** — feature currently not implemented.

## The XPression INcoder - Configuration Tab

The following screen capture displays the main elements of the **Configuration** tab in the **XPression INcoder Manager**.

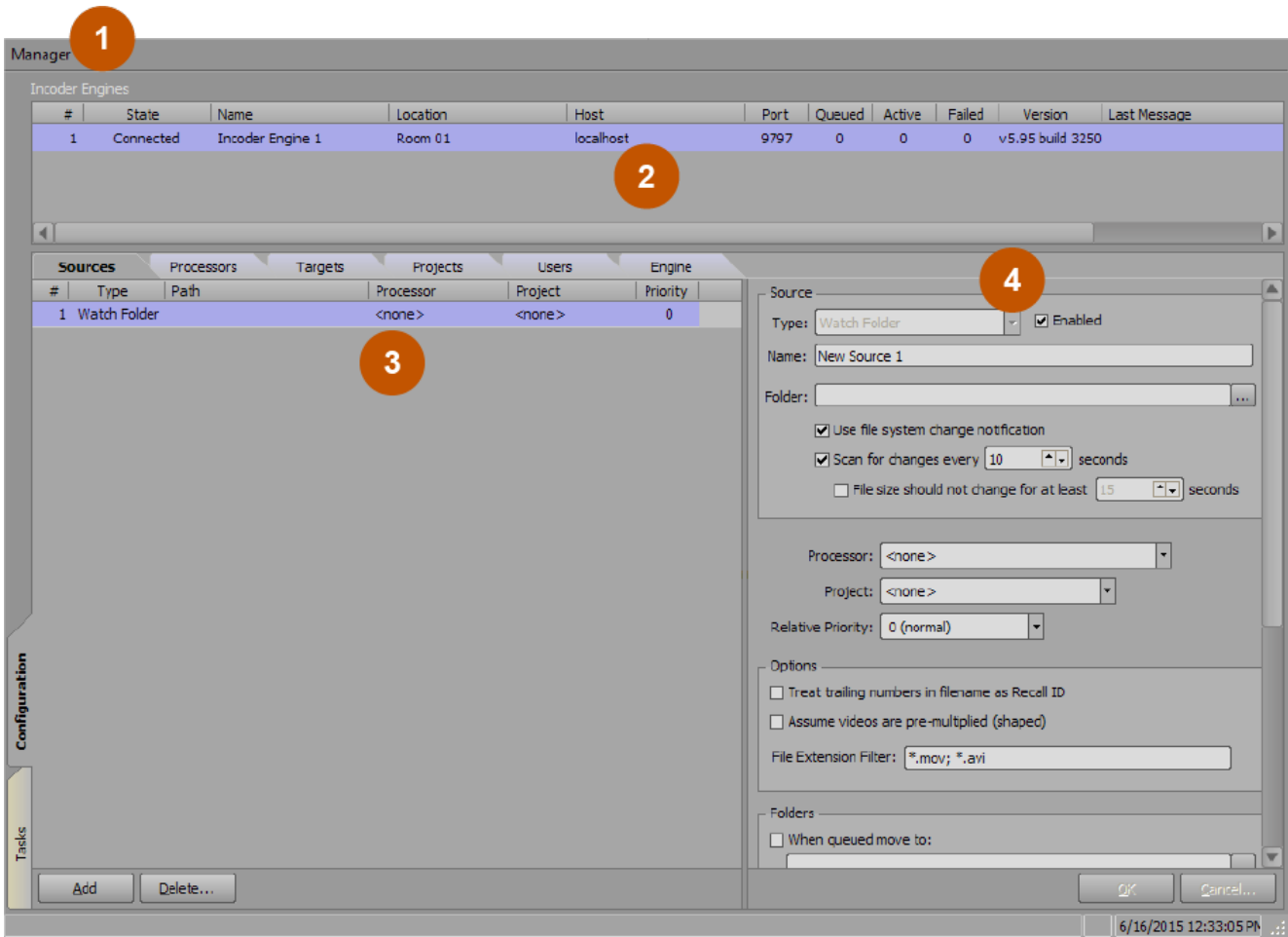

- 1) **Menu Bar** — use the **Manager** menu to exit XPression INcoder.
- 2) **INcoder Engines** — view the configured engines for XPression INcoder along with their state and details.
- 3) **Configuration Tabs** — use the configuration tabs to configure the INcoder engines, users, projects, targets, processors, and sources.
- 4) **Configuration Area** — use the configuration area to configure the settings and details for the selected configuration tab.

# Configuring the XPression INcoder

Use the XPression INcoder Manager to configure the XPression INcoder for use with XPression Clips.

## To configure the XPression INcoder:

1. On the machine that has the XPression INcoder installed, locate the XPression INcoder folder using the **Start** menu.
2. Select Start INcoder (  ) if the INcoder has not been started.

If the INcoder has successfully started, an information message indicates that the XPression INcoder was successfully started.

3. From the XPression INcoder folder, select **INcoder Manager**.

The **XPression INcoder Manager** opens.

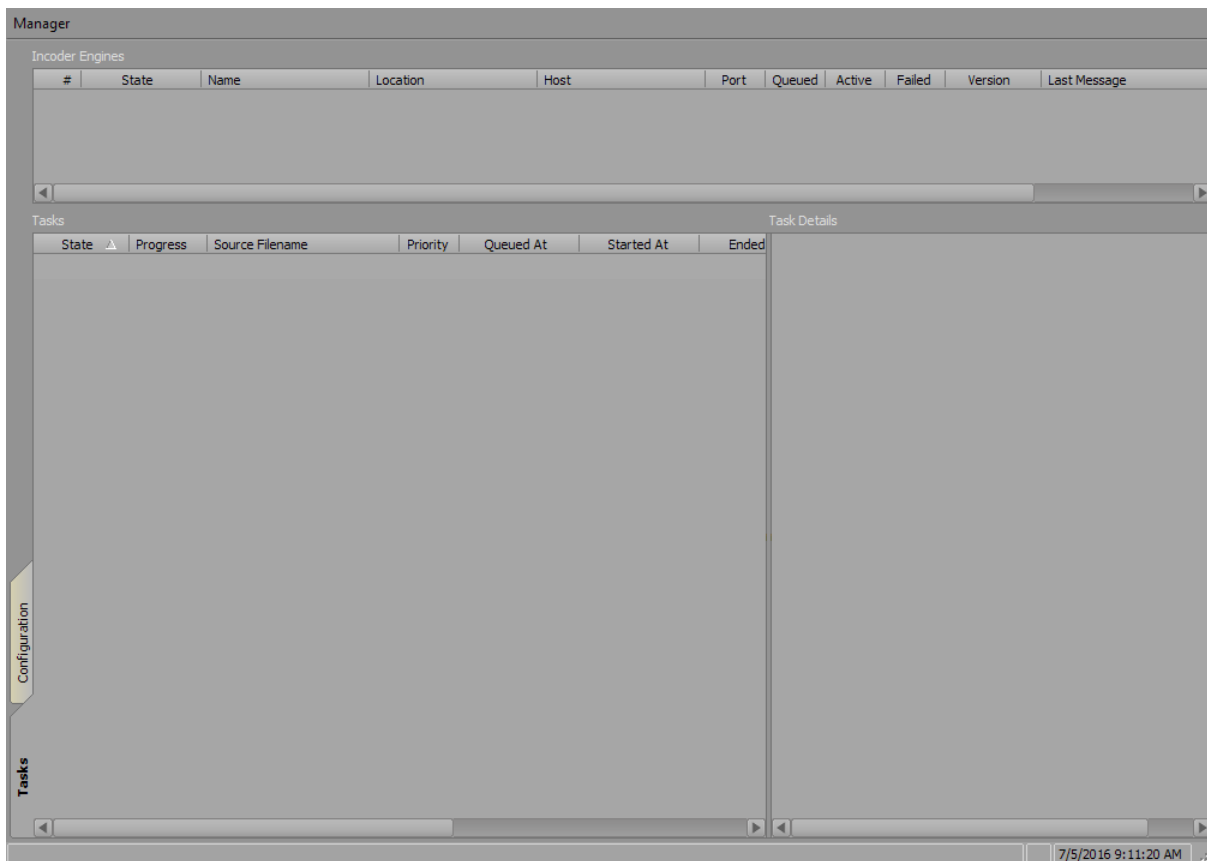

4. Select the **Configuration** tab.

The **Configuration** tab opens.

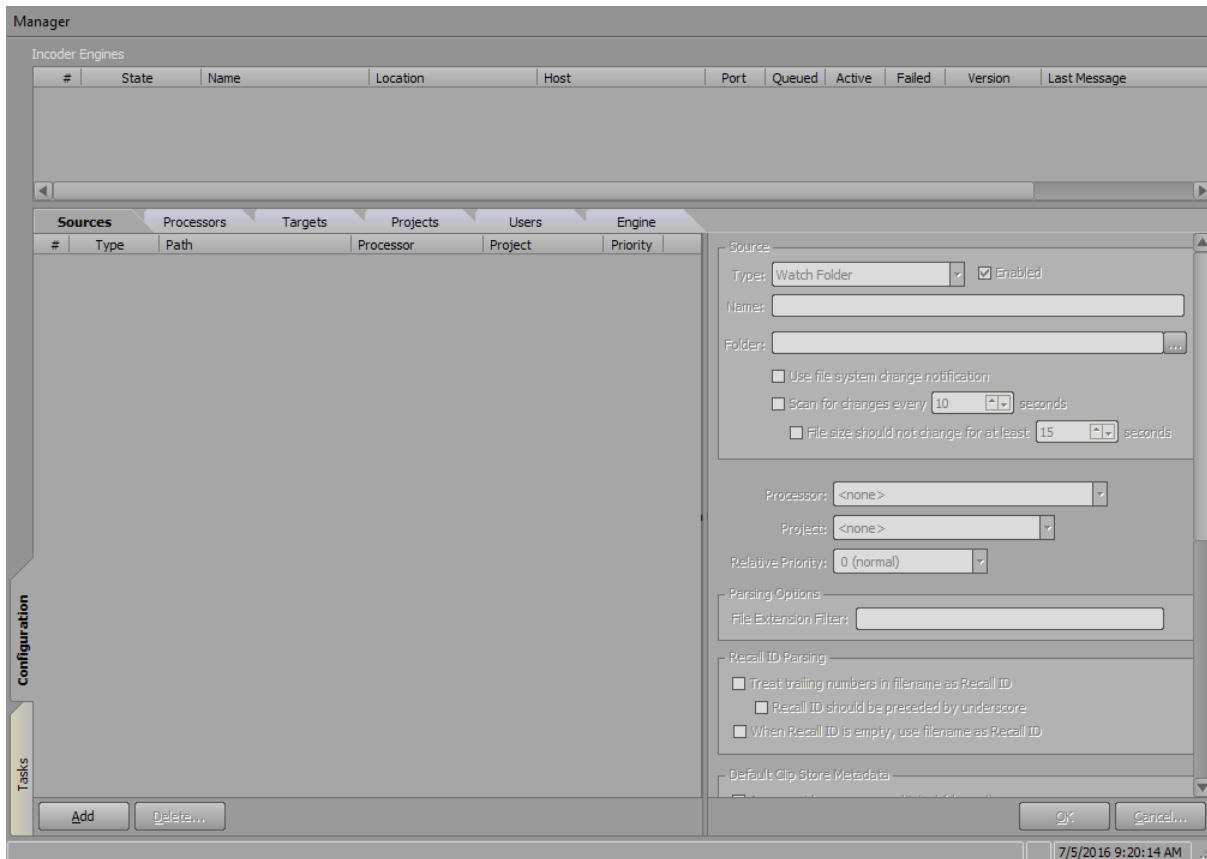

5. Configure the tabs from right to left:

## Engine

Use the following procedure to add and configure as many INcoder engines as needed.

### To add a new XPression INcoder engine:

1. In the **Configuration Manager**, go to the **Engine** tab.

The **Engine** tab opens.

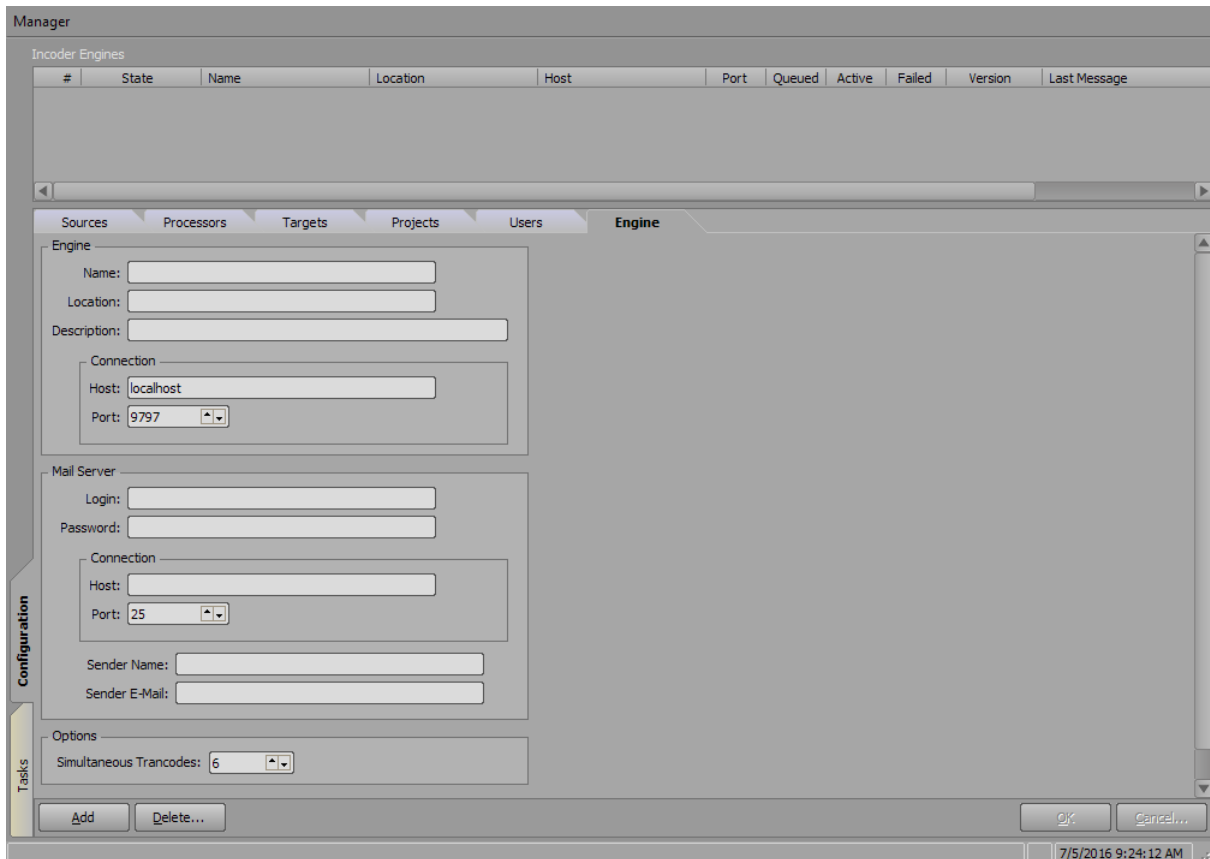

2. Select **Add**.

An engine is added to the **INcoder Engines** list.

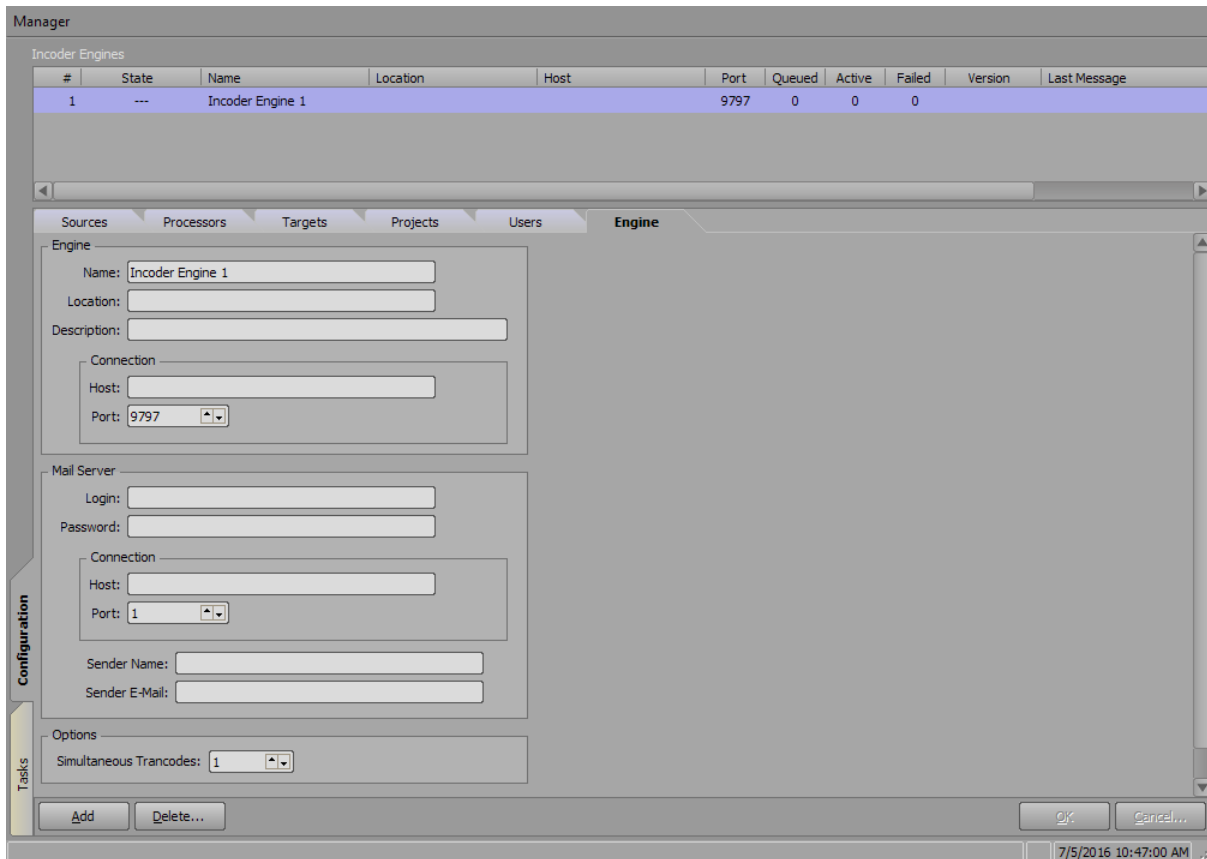

3. Configure the **Engine** section:

- In the **Name** field, enter a name for the INcoder engine.  
The default name is **INcoder Engine 1**.
- In the **Location** field, enter the location of the INcoder engine.
- In the **Description** field, enter a brief descriptor for the INcoder engine.
- In the **Host** field, enter the IP address of the INcoder service if using remotely.  
If using the INcoder service locally, enter **localhost**.
- In the **Port** field, enter or select the port number for the INcoder service connection.  
The default is **9797**.

4. Configure the **Mail Server** section:

- In the **Login** field, enter the user ID for access to the mail server.
- In the **Password** field, enter the password for the login user name.  
★ Consult your system administrator if you are uncertain of the login credentials.
- In the **Host** field, enter the IP address of the mail server.
- In the **Port** field, enter or select the port number for the mail server connection.  
The default is **25**.

- In the **Sender Name** field, enter a name for the sender of INcoder task status notifications.
  - In the **Sender E-Mail** field, enter the email address of the status information's originator.
5. In the **Options** section, in the **Simultaneous Transcodes** field, enter or select the number of video files that can be transcoded by the INcoder simultaneously.

Any videos beyond this amount will be queued until other video files have been transcoded.

★ Any time the number of transcodes is reduced, the INcoder must be stopped and restarted for the new **Simultaneous Transcodes** setting to take effect.

★ Currently, a maximum of eight **Simultaneous Transcodes** are available. However, the number of simultaneous transcodes should not be set higher than the number of CPU cores available on the machine.

6. Select **OK** to apply the settings.

The **Engine** settings are updated in the **INcoder Engines** list, and the **State** is **Connected**.

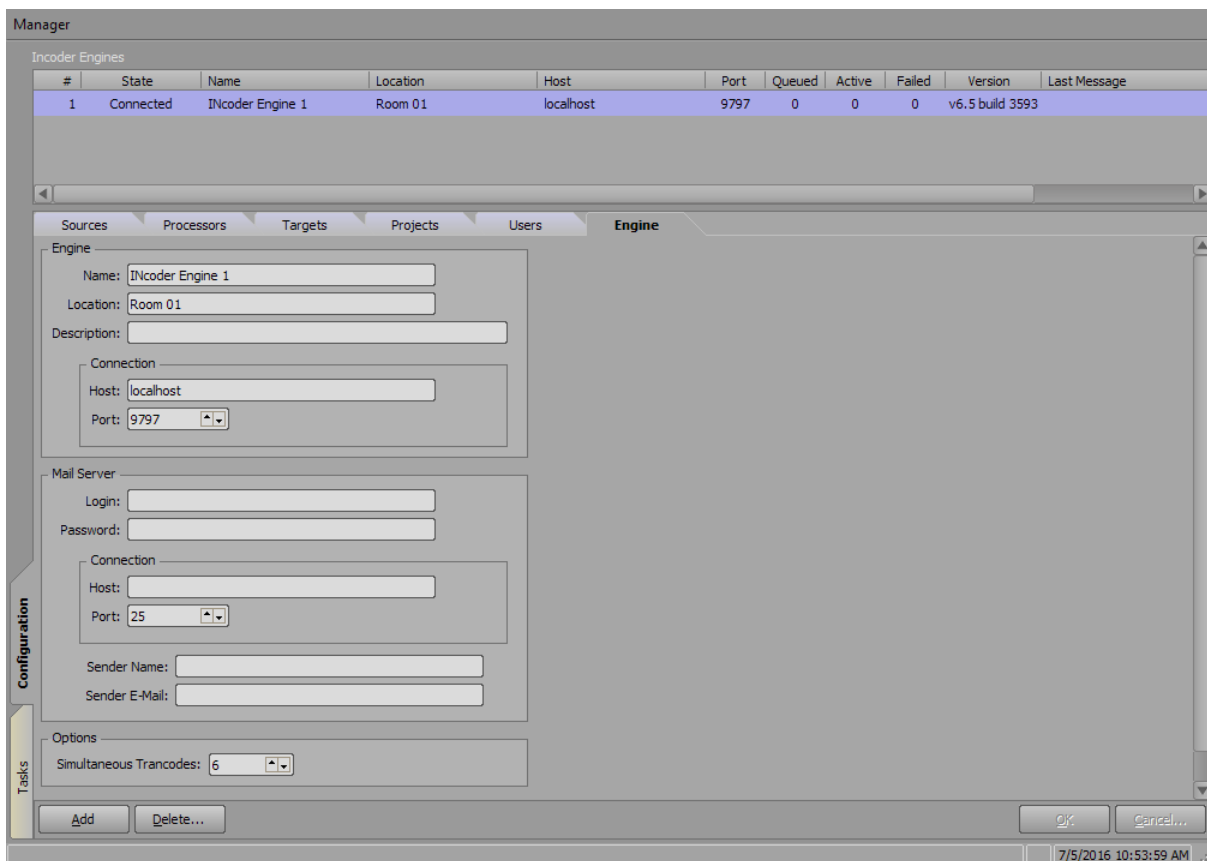

7. Repeat this procedure for as many engines as needed.

## Users

Use the following procedure to add and configure as many INcoder users as needed.

### To add a new XPression INcoder user:

1. In the **Configuration Manager**, go to the **Users** tab.

The **Users** tab opens.

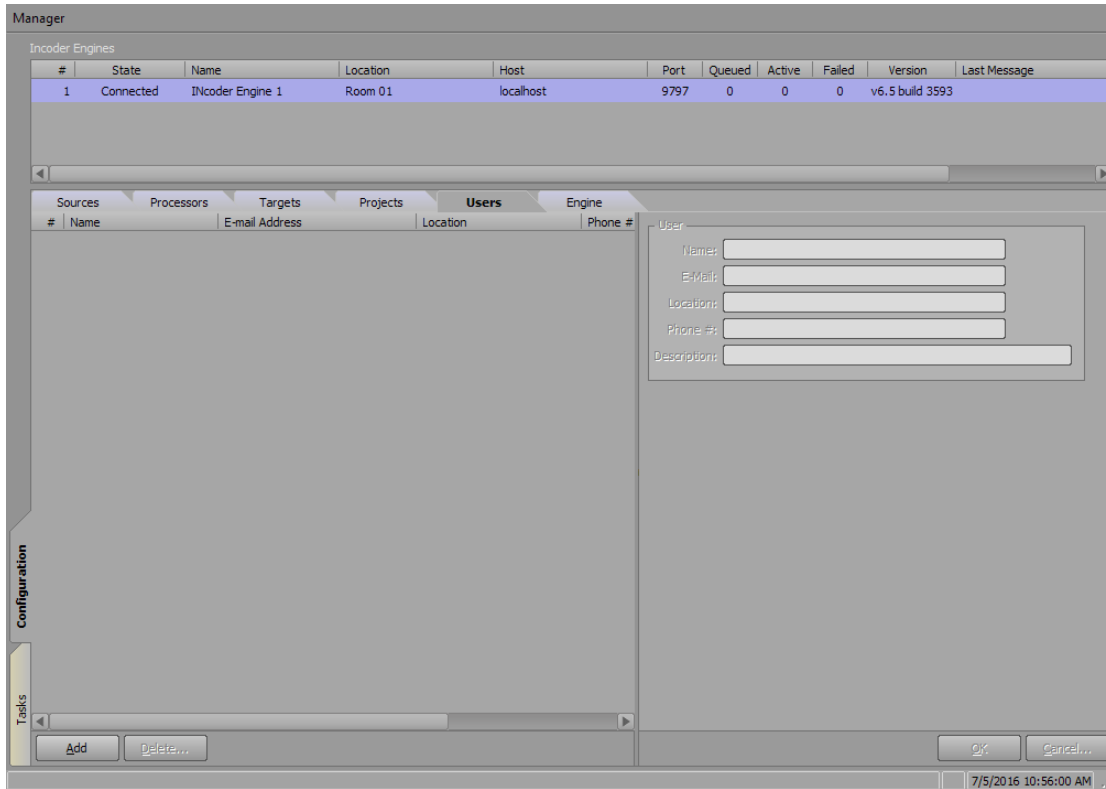

2. Select **Add**.

A new user is added to the **Users** list.

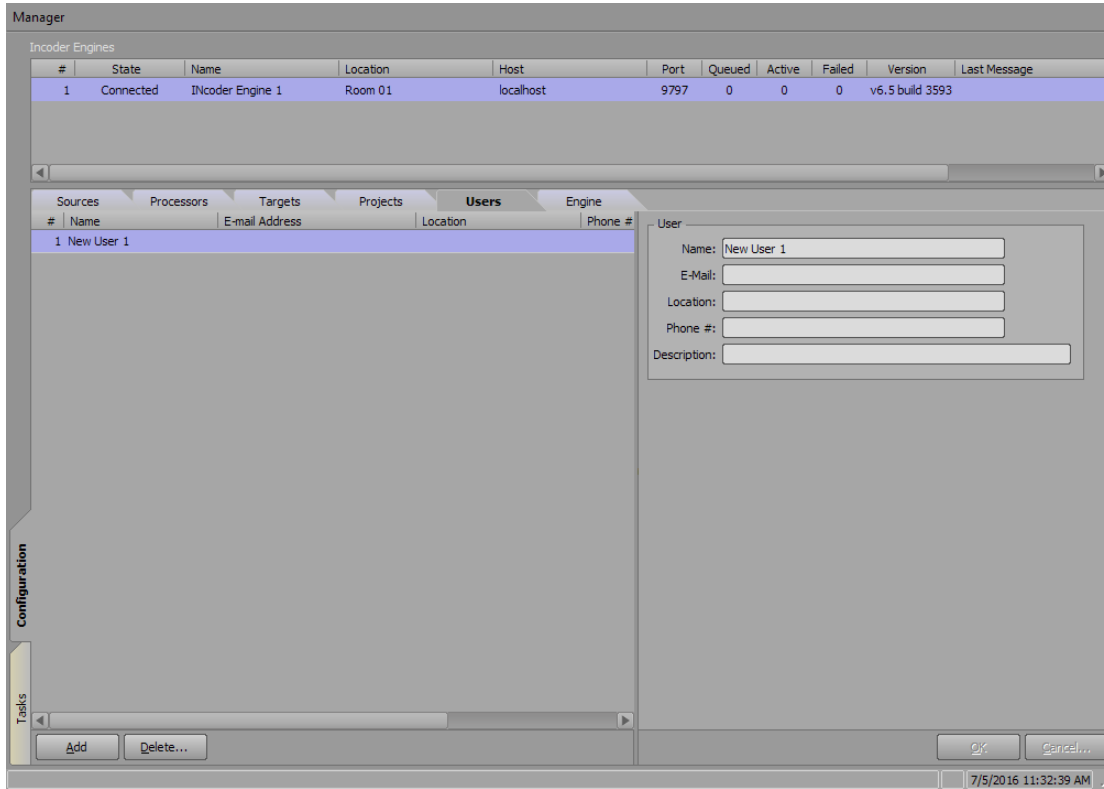

3. Configure the **User** section:

- In the **Name** field, enter a name for the user.  
The default is **New User 1**.
- In the **E-Mail** field, enter the email address where the user will receive Incoder status notifications.
- In the **Location** field, enter the location of the user, server, etc.  
For example, **Rack Room 01**.
- In the **Phone #** field, enter the phone number of the user.
- In the **Description** field, enter a brief descriptor for the user, such as their title or position.

4. Select **OK**.

The details are added to the user in the **Users** list.

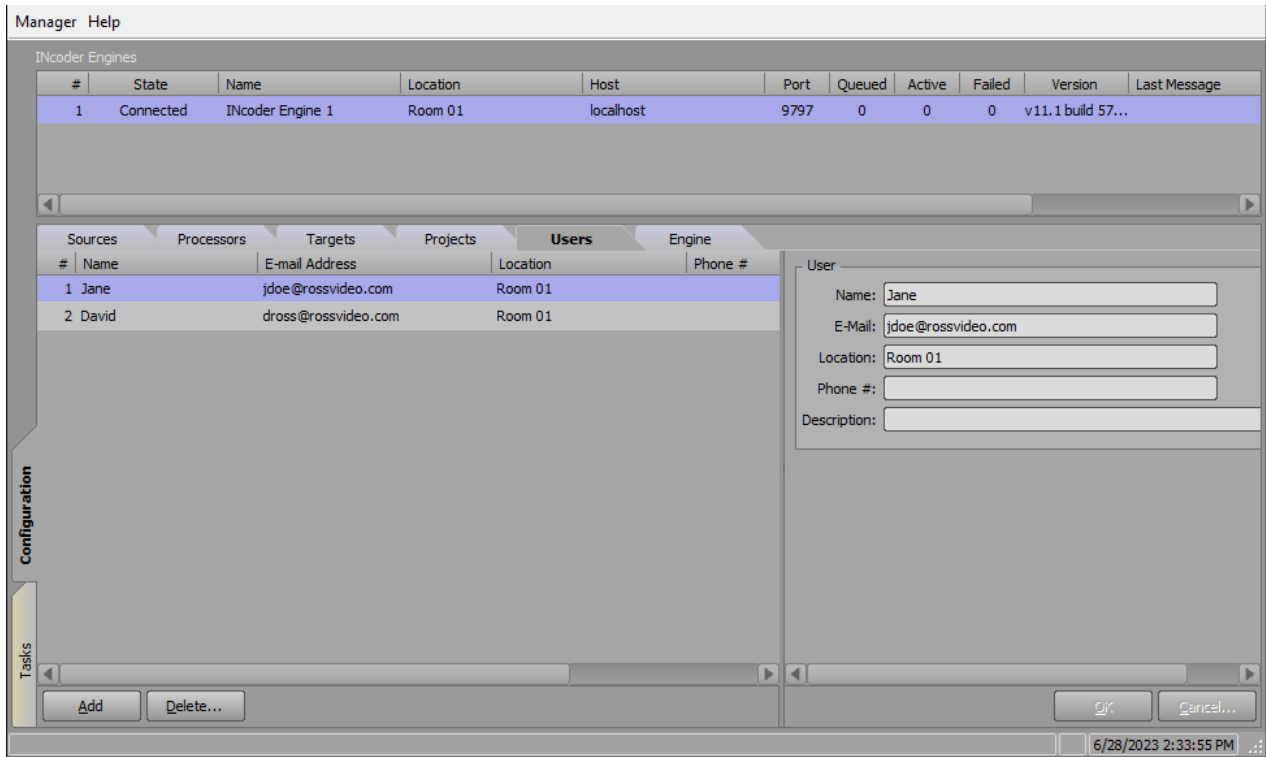

5. Repeat this procedure for as many users as necessary.

## Projects

Use the following procedures to add and configure as many INcoder projects as needed.

This section describes how to:

[Add a new XPression INcoder project](#)

[Configure the Notify Users on Completed settings](#)

[Configure the Notify Users on Failure settings](#)

[Apply the New Project settings](#)

### To add a new XPression INcoder project:

1. In the **Configuration Manager**, go to the **Projects** tab.

The **Projects** tab opens.

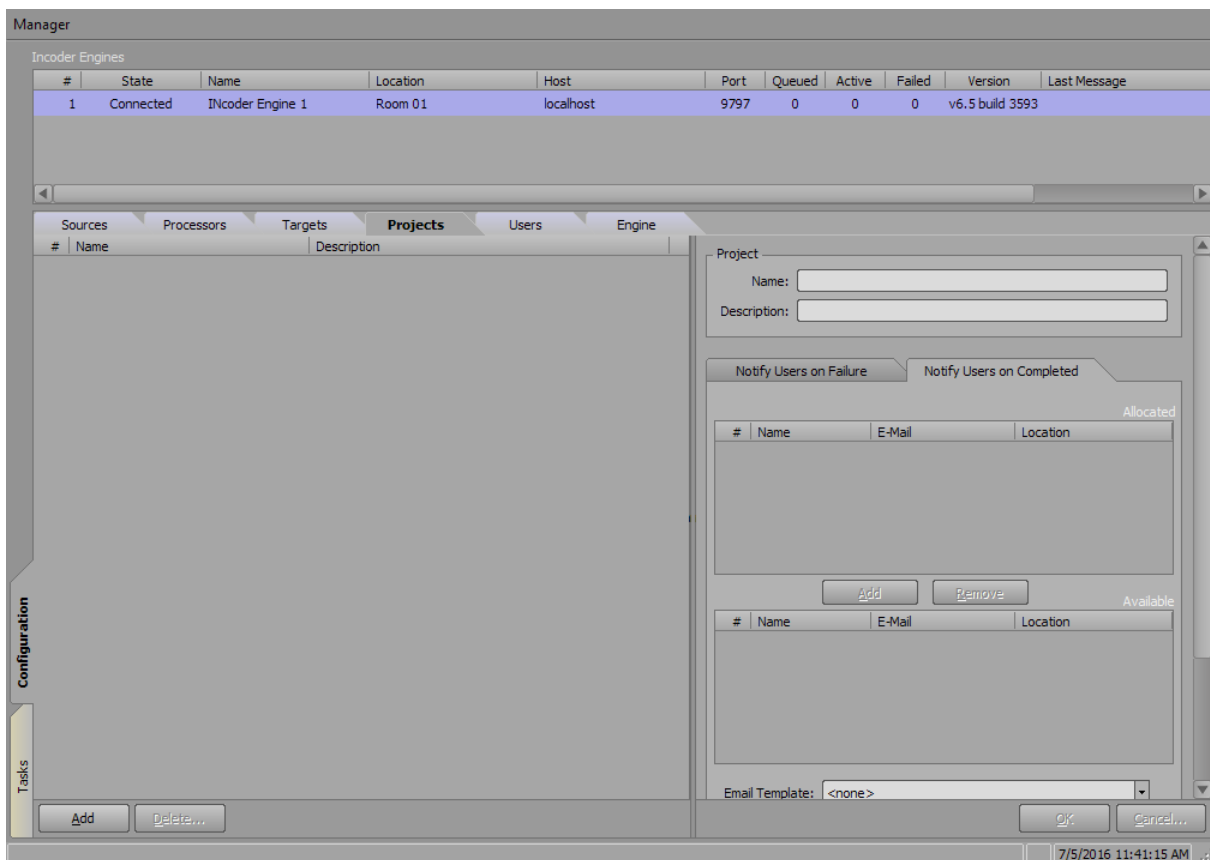

**Projects** filter which users have access to certain clips.

2. Select **Add**.

A **New Project** is added to the **Project List**.

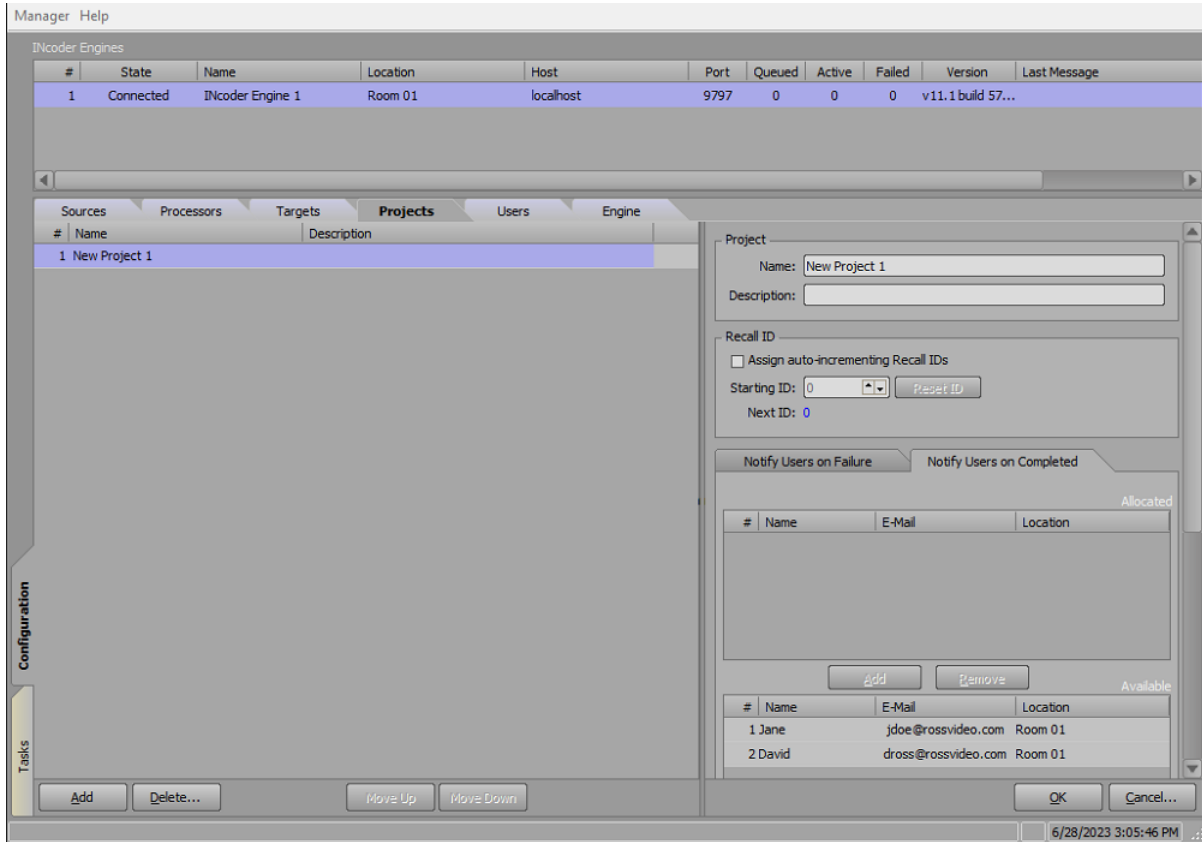

3. Configure the **Project** section:

- In the **Name** field, enter a project name.  
The default name is **New Project 01**.
- In the **Description** field, enter a brief descriptor for the project.

4. Configure the **Recall ID** section:

- Select the **Assign auto-incrementing Recall IDs** checkbox to automatically assign incrementing **Recall IDs** to clips for the selected project when no **Recall ID** has been assigned via the **Filename parsing** settings in the **Watch folder**.
- In the **Starting ID** field, enter or select the **Recall ID** number at which to begin assigning the auto-incrementing **Recall ID** numbers to clips.
- Select the **Reset ID** button to reset the next ID to be the new starting ID.

## To configure the Notify Users on Completed settings:

1. Go to the **Notify Users on Completed** tab.
2. Select a user from the **Available** users list, and then select **Add**.

The user is added to the **Allocated** users list.

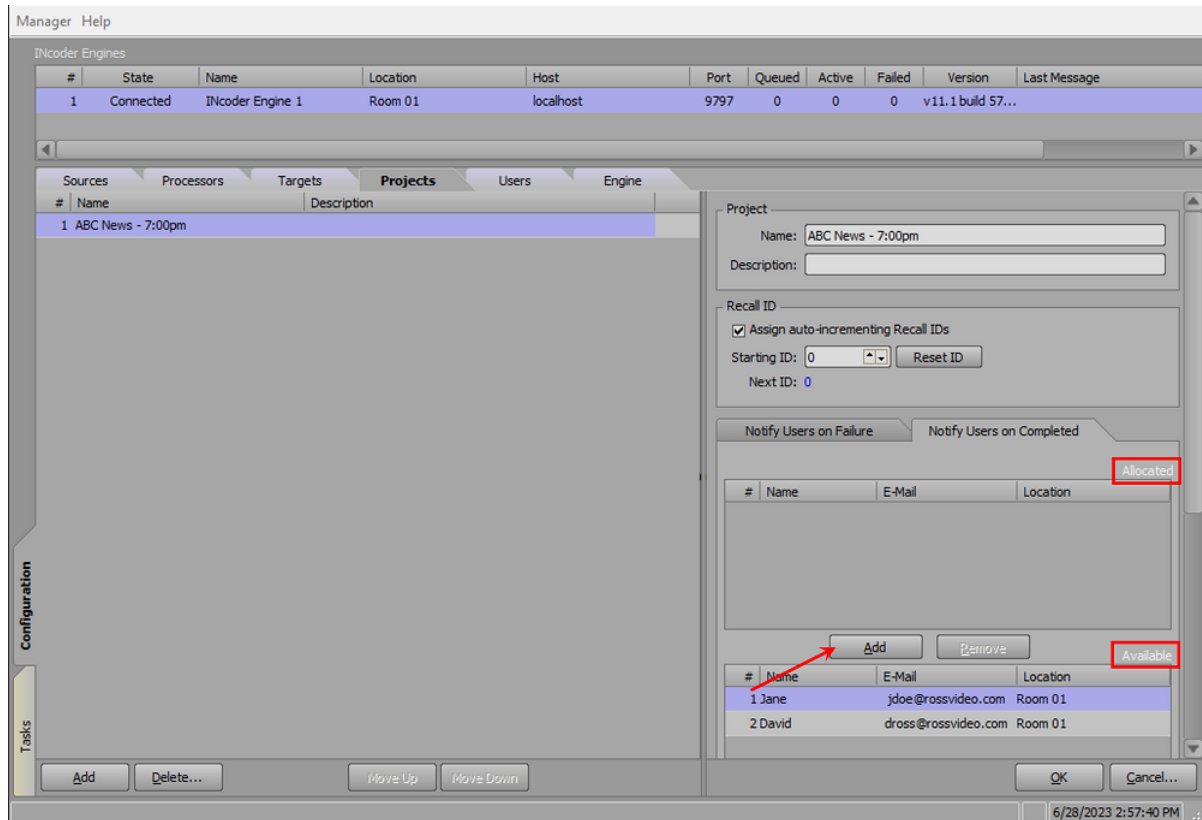

3. In the **Project Details** section, scroll down to the **Email Template** settings and from the **Email Template** drop-down, select the template that will be used for the outgoing status email.

The options are:

- Select **<none>** to use no template and receive no email notifications.
- Select **sample-completed.html** to use the **sample-completed HTML template** for the notification.
- Select **sample-failed.html** to use the **sample-failed HTML template** for the notification.

★ Custom templates can be added to the **EmailTemplates** folder. Find the **EmailTemplates** folder in C:\Program Files (x86)\XPression INcoder.

4. Configure the batch notification settings:

- Select the **Notify in batch every** checkbox to notify users of multiple successful transcodes in bulk, at the time interval entered in the **minutes** field.
- Select the **Notify in batch when project queue empties** checkbox to notify users of multiple successful transcodes, once the queue of videos being transcoded in the INcoder **Tasks** list is empty.
- In the **Batch limit** field, enter or select a limit on the number of ingested files that are included in the batch for the notification.

If both batch notification options are selected, the queue notification option will still occur even if it occurs before the batch notification time interval.

5. Select **OK**.

**To configure the Notify Users on Failure settings:**

1. Go to the **Notify Users on Failure** tab.
2. Select a user from the **Available** users list, and then select **Add**.

The user is added to the **Allocated** users list.

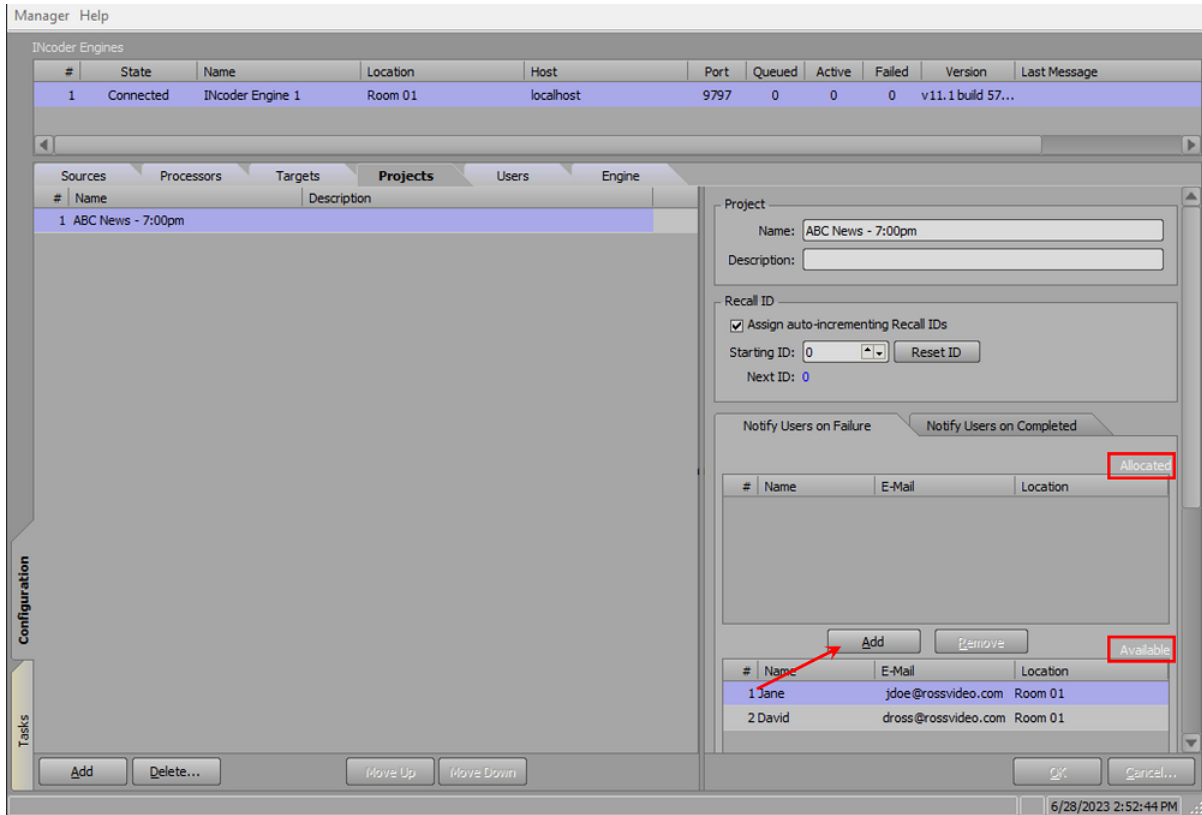

3. In the **Project Details** section, scroll down to the **Email Template** settings and from the **Email Template** drop-down, select the template that will be used for the outgoing status email.

The options are:

- Select **<none>** to use no template and receive no email notifications.
- Select **sample-completed.html** to use the **sample-completed HTML template** for the notification.
- Select **sample-failed.html** to use the **sample-failed HTML template** for the notification.

★ Custom templates can be added to the **EmailTemplates** folder. Find the **EmailTemplates** folder in C:\Program Files (x86)\XPression INcoder.

4. Configure the batch notification settings:

- Select the **Notify in batch every** checkbox to notify users of multiple failed transcodes in bulk, at the time interval entered in the **minutes** field.
- Select the **Notify in batch when project queue empties** checkbox to notify users of multiple failed transcodes, once the queue of videos being transcoded in the **Tasks** list is empty.
- In the **Batch limit** field, enter or select a limit on the number of ingested files that are included in the batch for the notification.

If both batch notification options are selected, the queue notification option will still occur even if it occurs before the batch notification time interval.

5. Select **OK**.

**To apply the new project settings:**

1. Once the project settings have been configured and the user notification settings have been set, select **OK**.

The **Projects** list is updated.

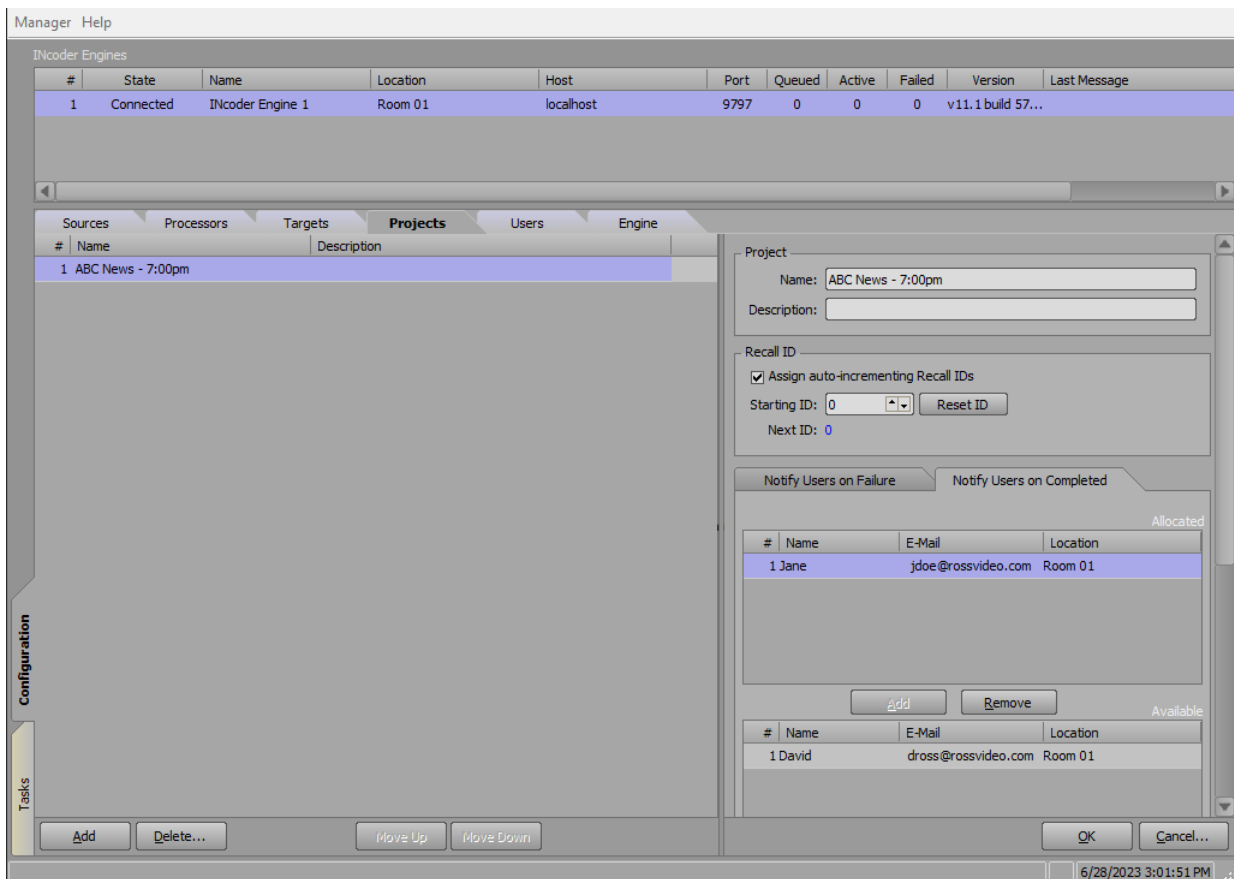

2. Repeat this procedure for as many projects as necessary.

## Targets

Use the following procedure to add and configure as many INcoder targets as needed.

### To configure destination targets for clips:

1. In the **Configuration Manager**, go to the **Targets** tab.

The **Targets** tab opens.

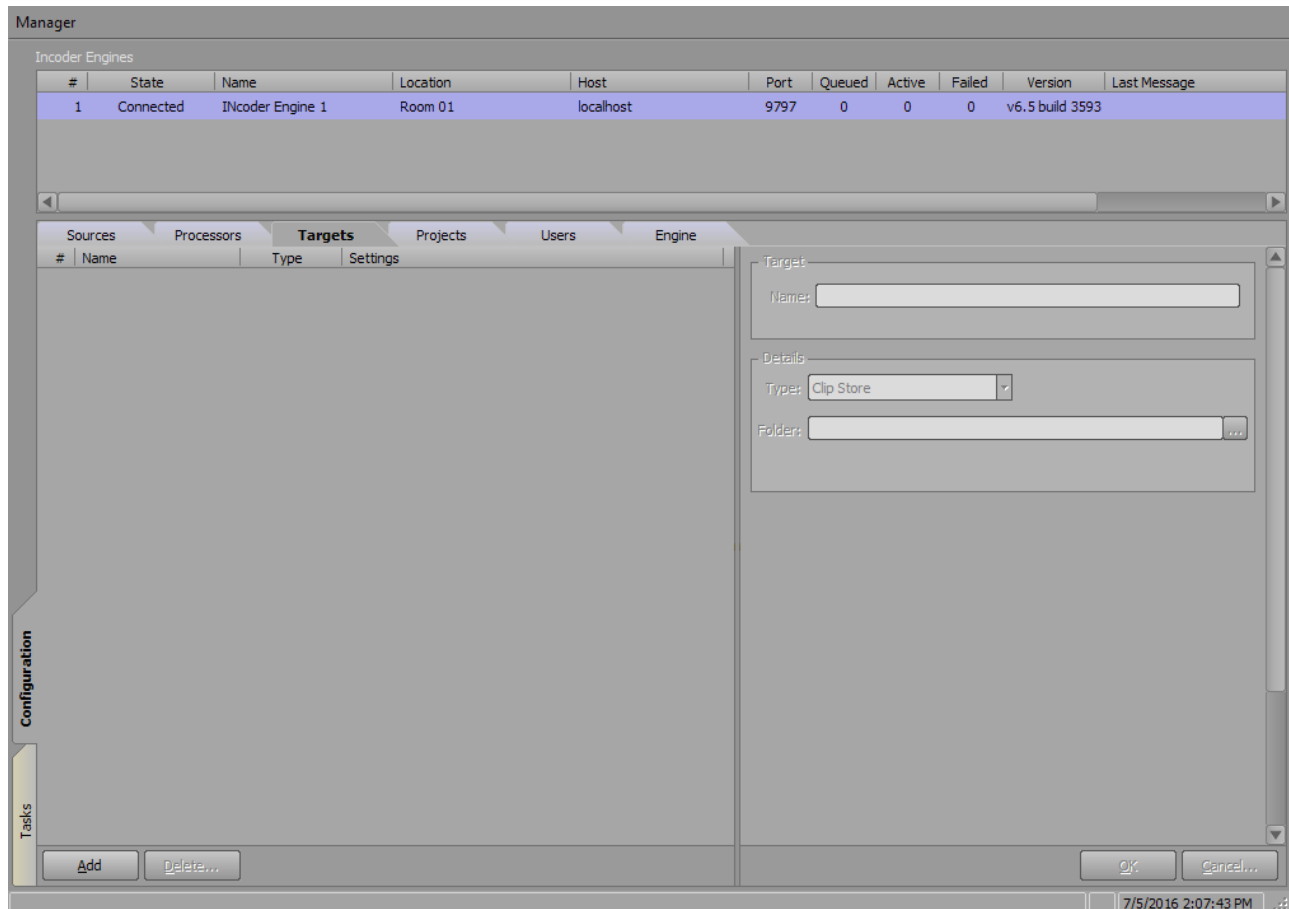

2. Select **Add**.

A new target is added to the **Targets** list.

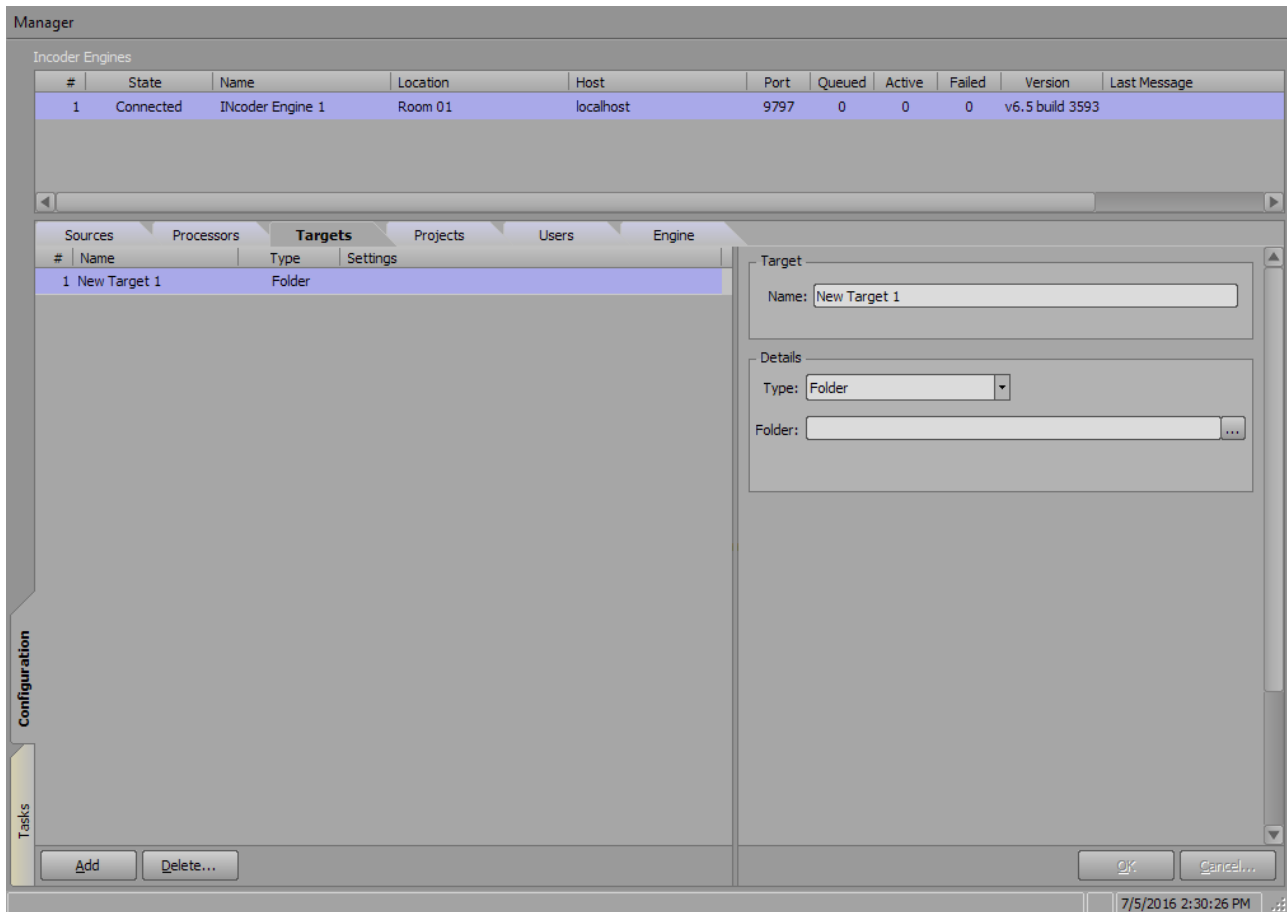

3. In the **Target** section, in the **Name** field, enter a name for the new target.

The default is **New Target 1**.

4. In the **Details** section, from the **Type** drop-down, select the destination type for the target.

The options are:

- **Folder** — send encoded clips to a destination folder.

➤ In the **Folder** field, select **Browse** to choose a folder, or enter the file path to a folder.

If using a network drive, enter the full network path as opposed to the mapped drive letter. For example, `\\srvtor02\Clips\Transfer` as opposed to `G:\Transfer`.

- **Clip Store** — send encoded clips from the **Watch Folder** to the **XPression Clip Store Manager**.

➤ In the **Host** field, enter an IP address for the **Clip Store Manager** location, or use **localhost** (default) if the **Clip Store Manager** is on the same machine as INcoder.

➤ In the **Port** field, enter or select the port number for the **Clip Store Manager** location.

The default is **9595**.

★ To use the **Clip Store** option, **XPression Clips** must be purchased and installed separately.

5. Select **OK**.

The settings are added to the **Targets** list.

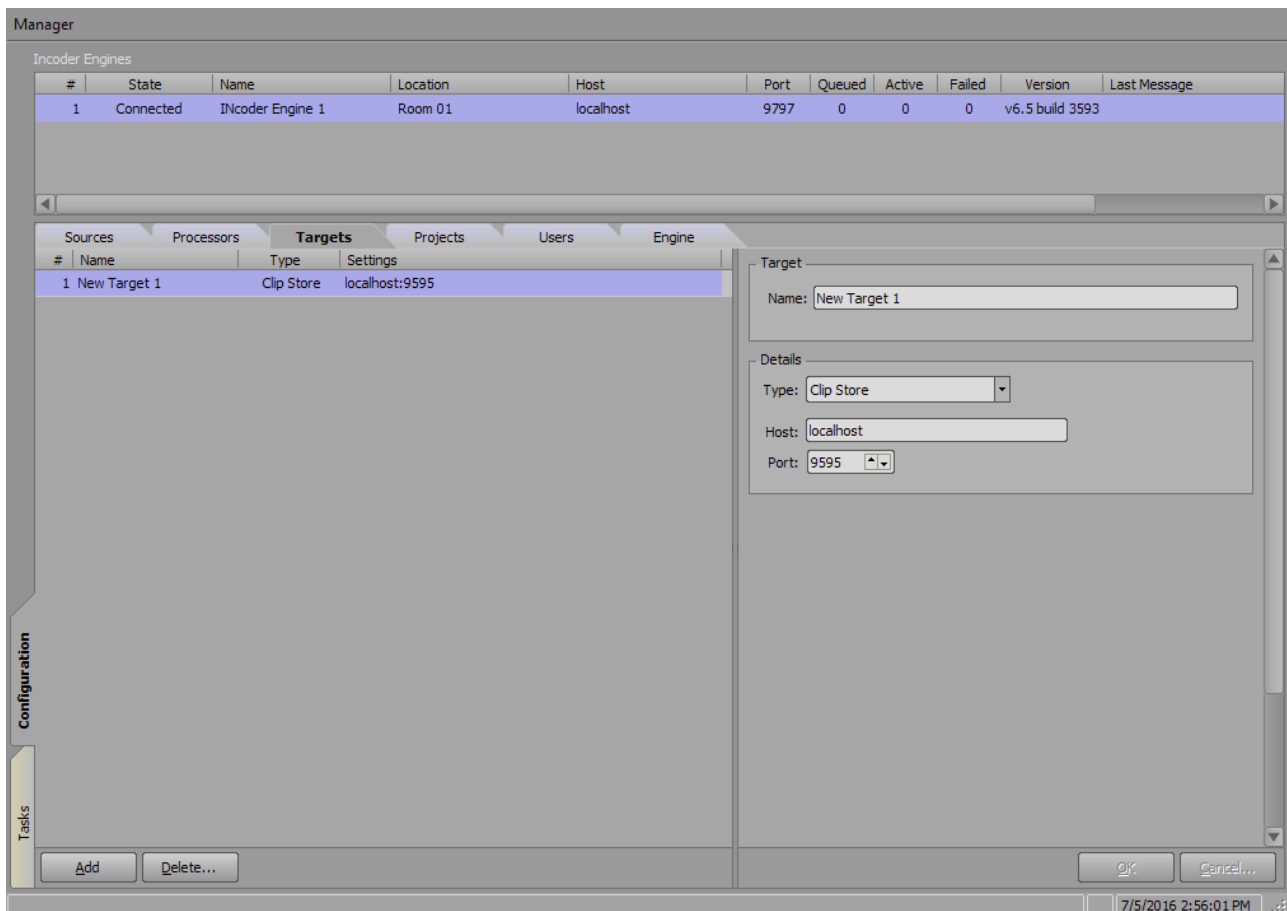

6. Repeat the procedure for as many targets as necessary.

## Processors

Processors are used to delegate the targets used for a source. Use the following procedures to add, and configure as many INcoder processors as needed.

★ If you are using **XPression Tessera**, you will need to configure the **Region Mapping** tab to split clips that are larger than HD and UHD resolutions and need to be divided into multiple segments in order to be spread across multiple render engines.

See [To configure Region Mapping for use with XPression Tessera](#) for instructions.

This section describes how to:

[Configure XPression INcoder Processors](#)

[Configure Region Mapping for use with XPression Tessera](#)

### To configure XPression INcoder processors:

1. In the **Configuration Manager**, go to the **Processors** tab.

The **Processors** tab opens.

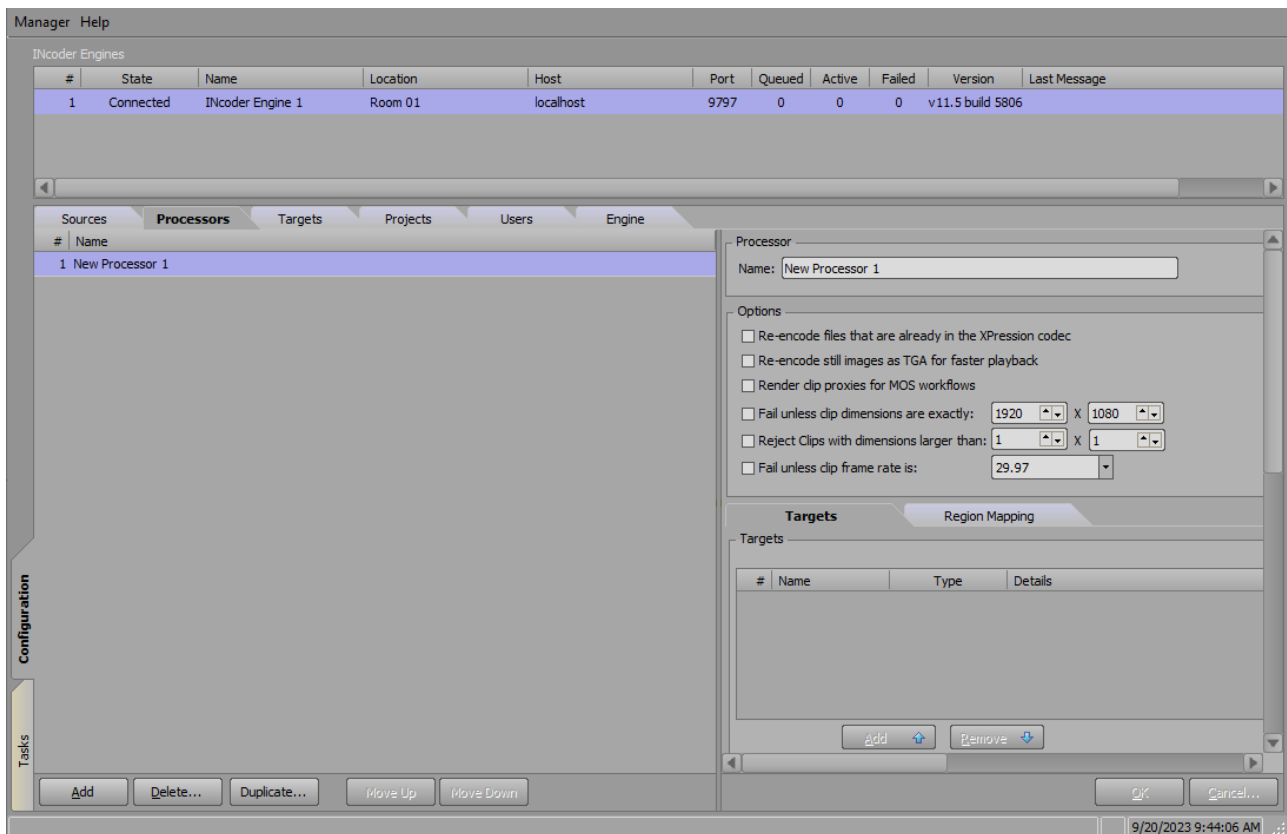

2. Select **Add**.

A **New Processor** is added to the **Processors** list.

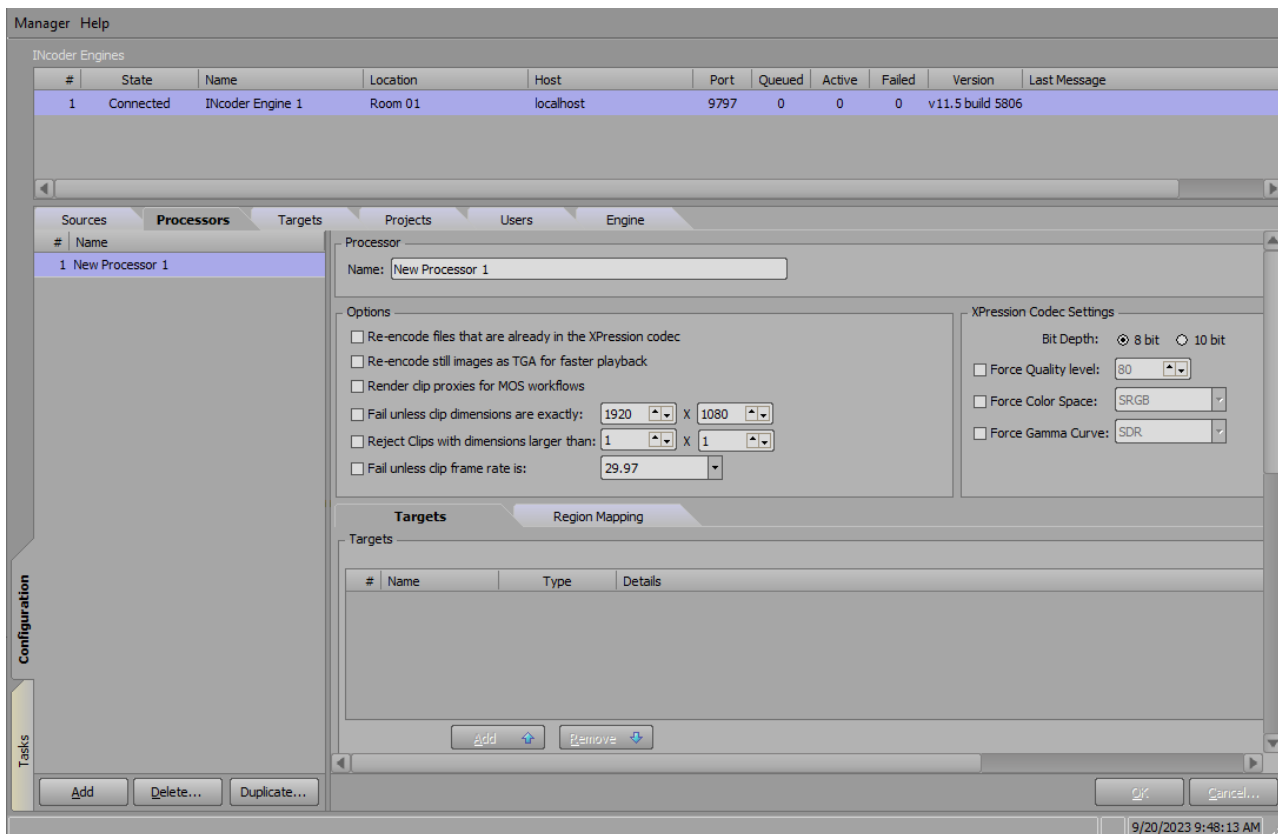

3. In the **Processor** section, in the **Name** field, enter a name for the processor.

The default is **New Processor 1**.

4. In the **Options** section, configure the following options:

- Select the **Re-encode files that are already in the XPression codec** checkbox to force XPression encoded files to be re-encoded.
- Select the **Re-encode still images as TGA for faster playback** checkbox to re-encode and convert all types of still images (.JPG, .TIFF, .PNG, etc.) as .TGA files for faster loading.  
This option uses more disk space.
- Select the **Render clip proxies for MOS workflows** checkbox to generate proxies of the clips being transcoded.  
The proxies are used to preview the clips in the **HTML5 MOS** plugin.
- Select the **Fail unless clip dimensions are exactly** checkbox to force the processor to only handle clips of a specified dimension or fail otherwise; in the fields, enter or select the **width** and **height** for specific clip dimensions for the processor to enforce.
- Select the **Reject Clips with dimensions larger than** checkbox to enable INcoder to reject clips larger than a specified dimension; in the fields, enter or select the maximum **width** and **height** that INcoder will accept.
- Select the **Fail unless clip frame rate is** and from the drop-down select the frame rate you want to use. This will prevent a clip from running if it has a different frame rate than the one specified.

5. In the **XPression Codec Settings** section, configure the following options:

Select a **Bit Depth** of **8 bit** or **10 bit**.

- Select the **Force Quality Level** checkbox to force the quality level entered or selected in the field.
- Select the **Force Color Space** checkbox to force the color setting selected from the drop-down.
- Select the **Force Gamma Curve** checkbox to force the gamma curve setting selected from the drop-down.

6. In the **Targets** tab, select a target from the **Available** targets list, and then select **Add**.

The target is added to the **Allocated** targets list.

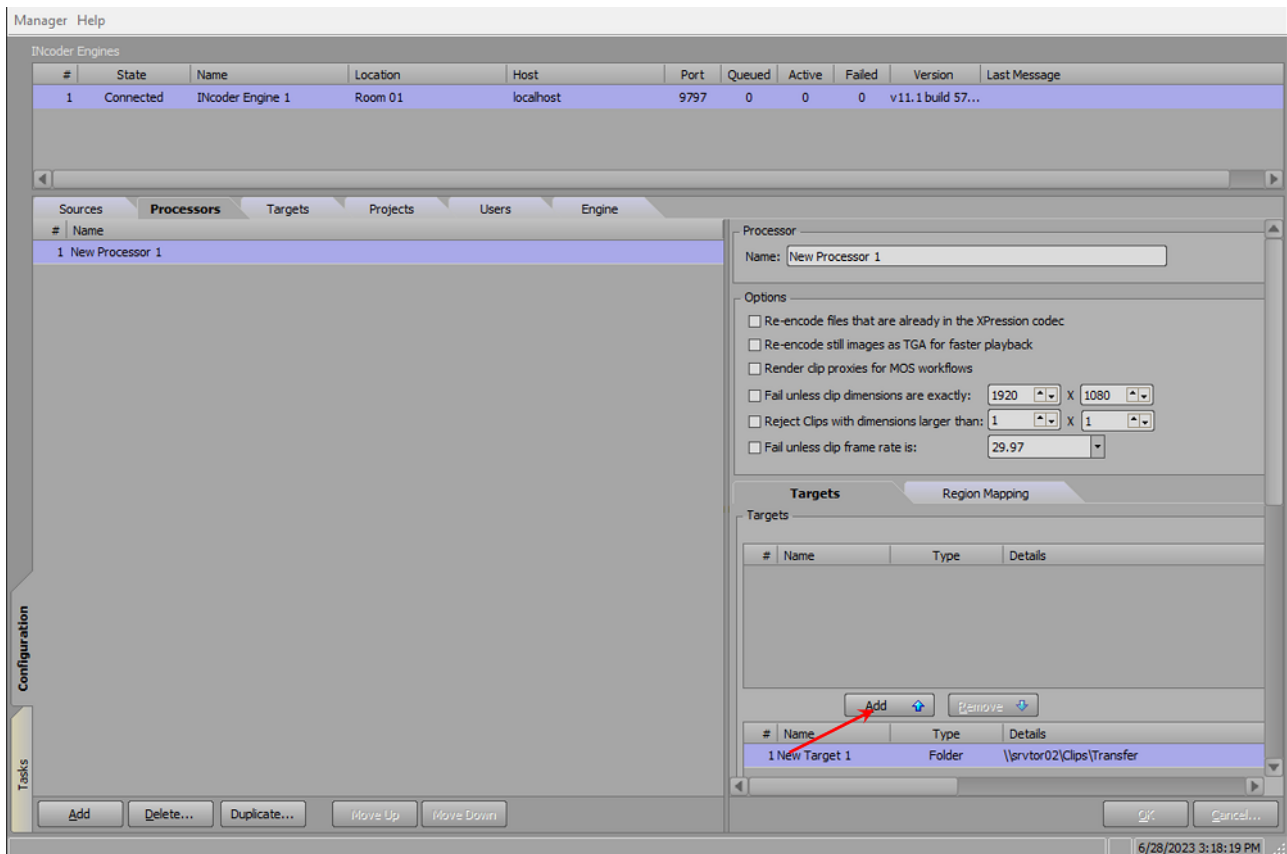

★ If you are using XPression Tessera, skip forward to the procedure [To configure Region Mapping for use with XPression Tessera](#), if not, continue with this procedure.

7. Select **OK** to add the processor and its target settings.

8. Repeat this procedure for as many processors as necessary.

Alternatively, choose an existing processor and select **Duplicate** to create a duplicate of the selected processor.

## To configure region mapping for use with XPression Tessera:

1. In the **Configuration Manager**, in the **Processors** tab, go to the **Region Mapping** tab.

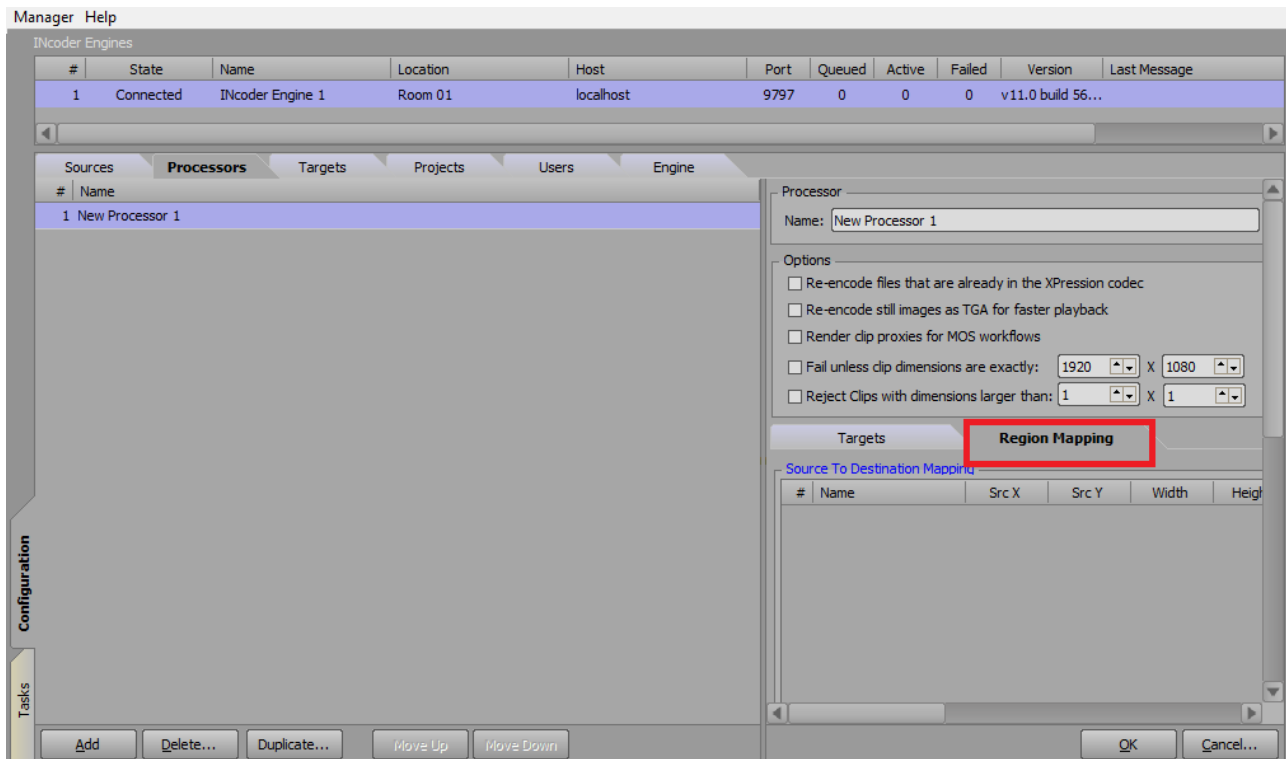

2. Scroll to the bottom of the **Region Mapping** tab and select **Add Region**.

Alternatively, right-click in the **Source To Destination Mapping** list and select **Add Region** from the shortcut menu.

A new region mapping is added to the **Source To Destination Mapping** list.

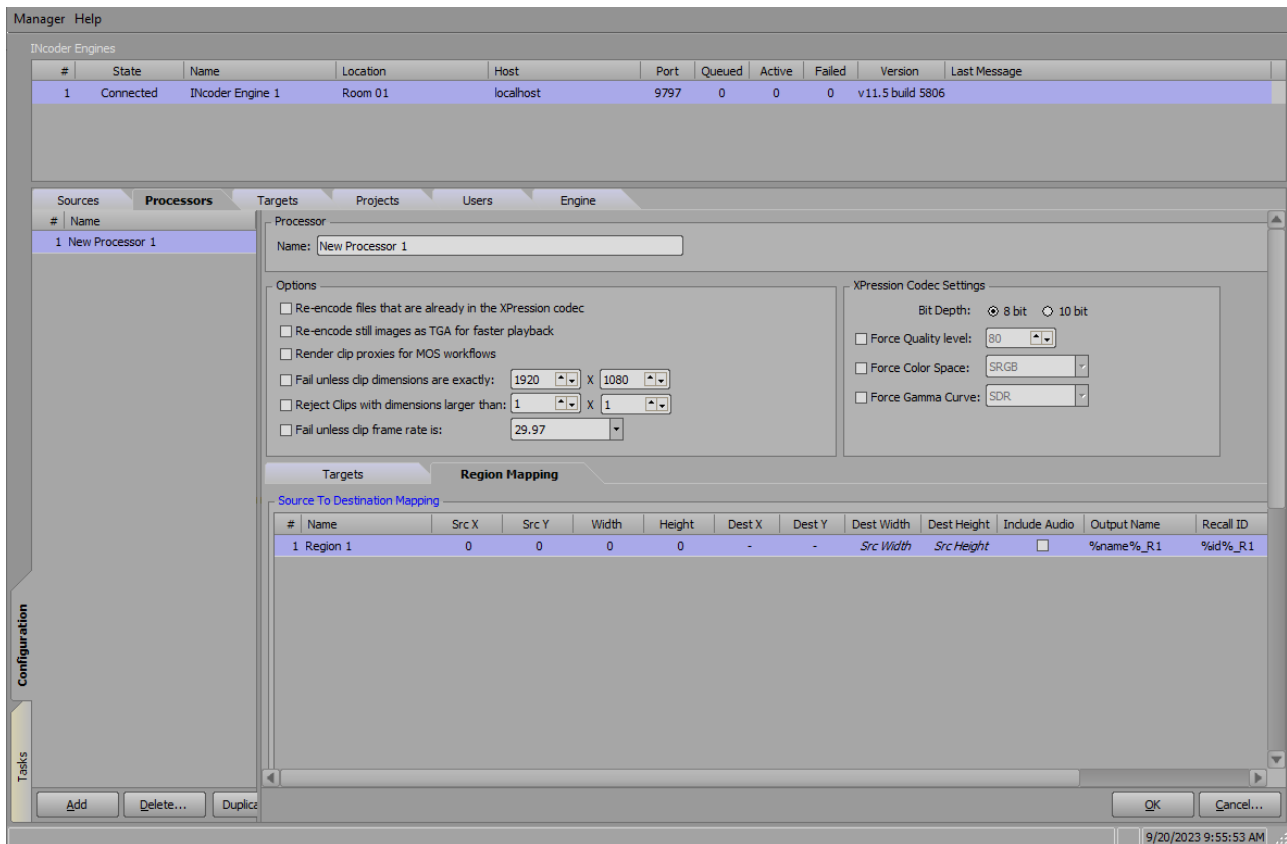

3. In the **Source To Destination Mapping** list, configure the mapping:

- In the **Name** column, select to enter a name for the new region.
- In the **Src X** column, select to enter or select the starting point within the clip dimensional coordinates along the X-axis for the source.  
**Src X** is measured from the upper-left corner of the clip that is added.
- In the **Src Y** column, select to enter or select the starting point within the clip dimensional coordinates along the Y-axis for the source.  
**Src Y** is measured from the upper-left corner of the clip that is added.
- In the **Width** column, select to enter or select the width of the region at which the clip segment will be rendered.
- In the **Height** column, select to enter or select the height of the region at which the clip segment will be rendered.  
 ★ The section/segments do not have to be symmetrical, each segment can have its own unique dimension.
- In the **Dest X** column, select a cell to enter or select a region along the X axis within the clip as the destination.
- In the **Dest Y** column, select a cell to enter or select a region along the Y-axis within the clip as the destination.
- In the **Dest Width** column, select a cell to enter or select the scale of the width of the region.
- In the **Dest Height** column, select a cell to enter or select the scale of the height of the region.

4. Select the **Include Audio** checkbox to include the clip audio with the region mapping configuration.

In most cases, this would only need enabling on one segment.

5. In the **Output Name** column, select to enter an output name macro if necessary.

6. In the **Recall ID** column, select to enter a **Recall ID** macro if necessary.

For example, **%name%\_1, %id%\_1**

The **Recall ID** will match the name when the **When recall ID is empty, use filename as Recall ID** checkbox is enabled in the **Sources** tab.

7. Select **OK** to save your region mappings.

8. Repeat this procedure for as many processors as necessary.

#### **To configure sub regions:**

1. In a mapping, right-click and select **Add Sub Region** to configure a sub-clip if necessary.

Sub-clips use a portion of the original clip.

2. Configure the **Sub Region** fields:

- In the **Dest X** column, select a cell to enter or select the region within the clip along the X-axis for the destination.
- In the **Dest Y** column, select a cell to enter or select the region within the clip along the Y-axis for the destination.
- In the **Dest Width** column, select a cell to enter or select the scale of the width of the sub region.
- In the **Dest Height**, column, select a cell to enter or select the scale of the height of the sub region.

3. Select **OK** to add the processor and its target settings.

4. Repeat this procedure for as many processors as necessary.

Alternatively, choose an existing processor and select **Duplicate** to create a duplicate of the selected processor.

## Sources

Sources let you add **Watch Folders** and assign processors to them. **Watch Folders** are where clips are added for encoding. Use the following procedures to add and configure as many INcoder sources as needed.

This section describes how to:

[Add a new source to the INcoder Manager](#)

[Configure source settings](#)

[Configure parsing options](#)

[Configure Recall ID parsing](#)

[Configure the default clip store metadata](#)

[Designate source folders](#)

[Apply new source configurations](#)

### To add a new source to the INcoder Manager:

1. In the **Configuration Manager**, go to the **Sources** tab.

The **Sources** tab opens.

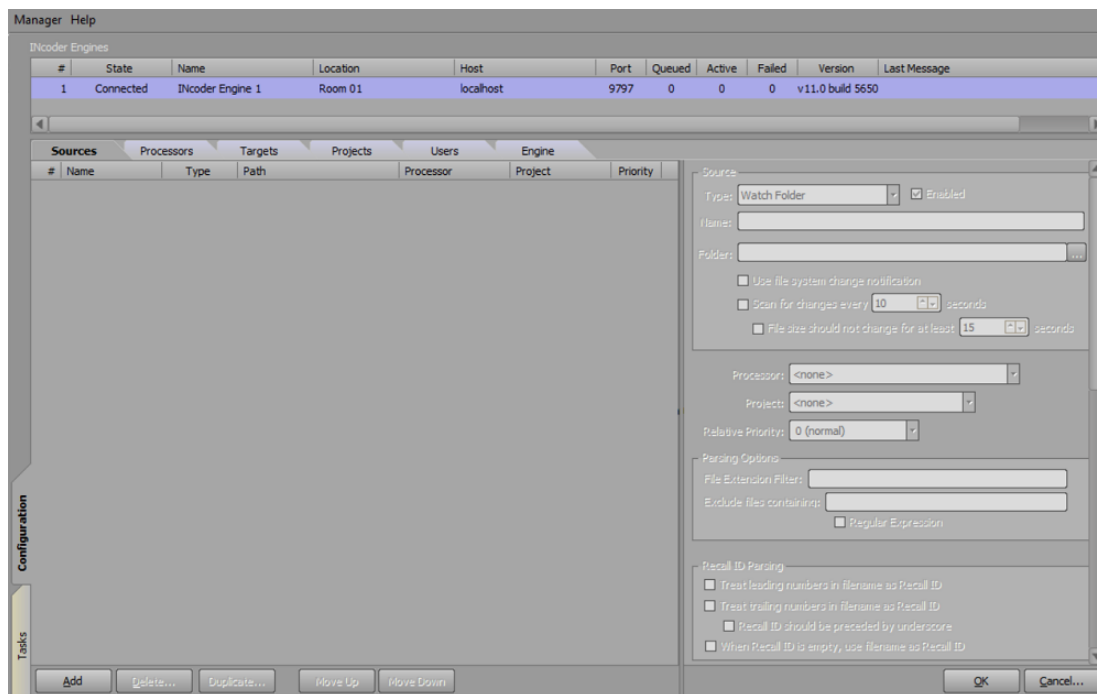

## 2. Select **Add**.

A **New Source** is added to the **Sources** list.

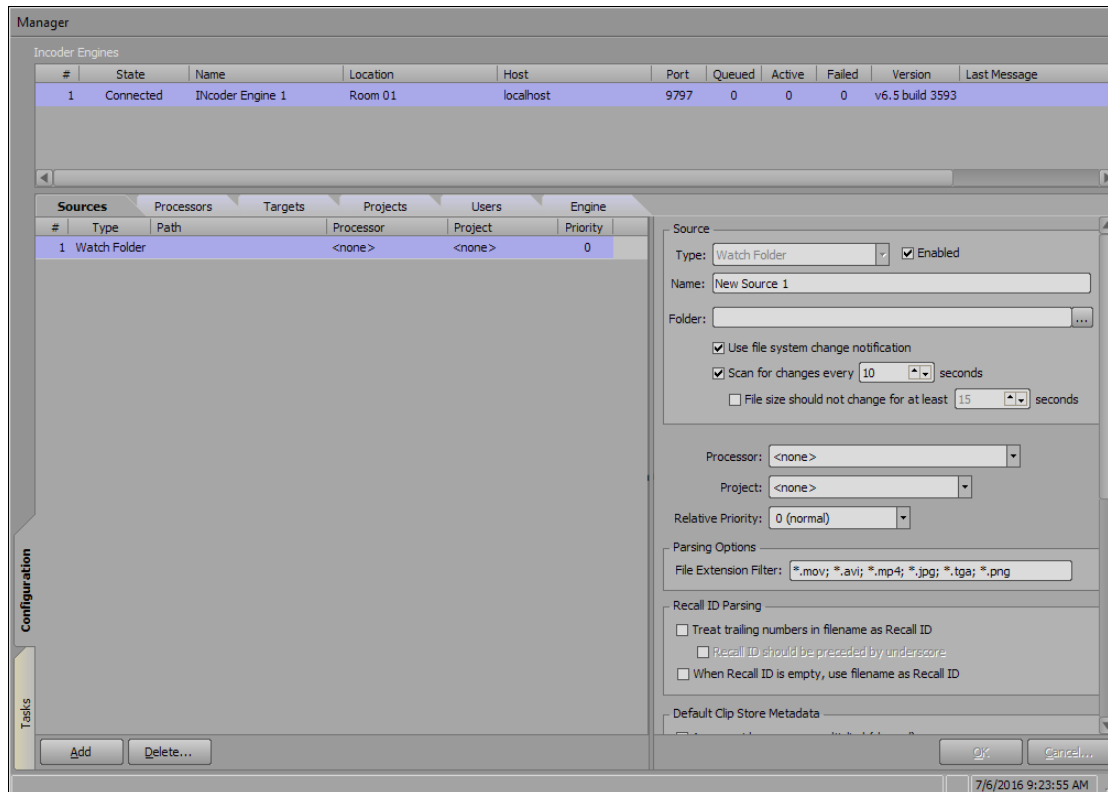

Currently, **Watch Folder** is the only available option and is enabled by default.

### To configure settings:

1. In the **Source** section, in the **Name** field, enter a name for the source.

The default is **New Source 1**.

2. In the **Folder** field, enter a file path to a folder or **Browse** to select a folder where INcoder will look for files to encode and send to the target.
3. Select the **Use file system change notification** checkbox to have any file changes to the source folders reflected in INcoder immediately.
4. Select the **Scan for changes every** checkbox, and then in the field, enter or select the frequency that INcoder scans the source for any changes.
5. Select the **File size should not change for at least** checkbox, and then in the field, enter or select the amount of time for INcoder to wait before the encoding of a file begins.

This is helpful with larger files where transferring might take a little longer.

6. From the **Processor** drop-down, assign a processor to the selected source.

The processor dictates the target of the selected source.

7. From the **Project** drop-down, assign a project to receive status notifications regarding clips in the selected source.

8. From the **Relative Priority** drop-down, assign a priority level to the source folder.

The default is **0**.

The order of priority ranges from **-5** (low) to **0** (normal) to **+5** (high). This is helpful if you have multiple sources, some of which are of a higher priority than others. Files from the higher priority sources will transcode before files from lower priority sources.

### To configure parsing options:

1. In the **Parsing Options** section, in the **File Extension Filter** field, enter file extensions accepted for transcoding by INcoder.

All file extensions need to be listed with an asterisk (\*) in front of the file extension and a semi-colon (;) between different file types.

INcoder currently supports **MOV, AVI, JPG, PNG, TGA, and TIF** files. Any unlisted file type is immediately blocked.

2. In the **Exclude files containing** field, enter any keywords, IDs, etc. for INcoder to exclude from transcoding.
3. Select the **Regular Expression** checkbox to search a sequence of characters that specify a search pattern in the text.

### To configure Recall ID parsing:

1. In the **Recall ID Parsing** section, select the **Treat leading numbers in filename as Recall ID** checkbox to use any numbers before the filename text, and the file extension as **Recall IDs**.

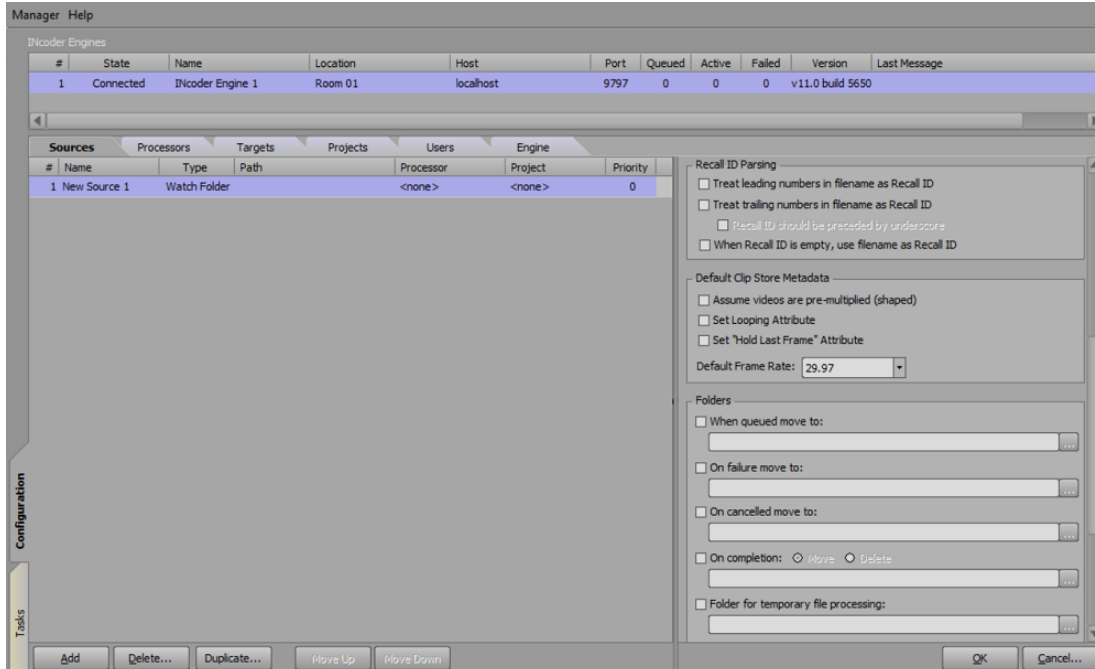

2. Select the **Treat trailing numbers in filename as Recall ID** checkbox to use any numbers between the filename text and the file extension as **Recall IDs**.

If **Treat trailing numbers in filename as Recall ID** is selected, then select **the Recall ID should be preceded by underscore** checkbox to only use trailing numbers in a filename as **Recall IDs** if the numbers are preceded by an underscore.

3. Select the **When Recall ID is empty, use filename as Recall ID** checkbox to use the filename to populate the **Recall ID** field if no other **Recall ID** has been explicitly set.

#### To configure the default Clip Store metadata:

1. In the **Default Clip Store Metadata** section, select the **Assume videos are pre-multiplied (shaped)** checkbox to assume that the videos multiply/shape the fill signal color information by the luminance information in the key signal.
2. Select the **Set Looping Attribute** checkbox to enable looped playback on the videos.
3. Select the **Set "Hold Last Frame" Attribute** checkbox to hold the video on the last frame when playout has completed.

This is also used to keep still images that are one frame in size on screen.

4. From the **Default Frame Rate** drop-down, select a frame rate for the video files in the folder.

★ If any of the checkboxes for **Assume videos are pre-multiplied (shaped)**, **Set Looping Attribute**, or **Set "Hold Last Frame" Attribute** have been selected, and you want to turn off those settings for a particular file, a **"FALSE"** string needs to be added to the tag in the filename. For example, **{LE}FALSE**.

The following tags are parsed from the names of files dropped into the **Watch Folder**:

- {GP} — Recall ID
- {HF} — Hold Last Frame
- {ID} — Recall ID
- {LE} — Loop Enabled
- {LFF} — Lower Field First
- {NA} — Name
- {PG} — Progressive video
- {PM} — Premultiplied/Shaped video
- {UFF} — Upper Field First

For example, a filename of **{NA}Snowstorm{GP}1000{LE}{PM}.mov** will be given a **Name** of **Snowstorm**, a **Recall ID** of **1000**, and will be set to **Looped** playback with **Shaped video**.

#### To designate source folders:

1. In the **Folders** section, select the **When queued move to** checkbox to move transcoding files to a selected folder when they are queued, and then enter a file path for the folder's destination or select **Browse** to select a folder.
2. Select the **On failure move to** checkbox to move files to the selected folder if the transcoding has failed, and then enter a file path for the folder's destination or select **Browse** to select a folder.
3. Select the **On canceled move to** checkbox to move transcoding files that have been canceled to the selected folder, and then enter a file path for the folder's destination or select **Browse** to select a folder.

4. Select the **On completion** checkbox and choose one of the following options for the files:
  - **Move** — Select this option to choose a folder to move the files to upon completion of transcoding, and then enter a file path for the folder's destination or select **Browse** to choose a folder.
  - **Delete** — Select this option to delete the files after transcoding is complete.
5. Select the **Folder for temporary file processing** checkbox to temporarily move the files to the chosen folder while transcoding, and then enter a file path for the folder's destination or select **Browse** to choose a folder.
  - ★ If no folder checkboxes are selected and no destination folders assigned, default folders will be created for these options.

**To apply new source configurations:**

1. Once the **Source** settings have been configured and the source folders have been designated, select **OK**.
2. Repeat this procedure for as many sources as necessary.

Alternatively, choose an existing source and select **Duplicate** to create a duplicate of the selected source.

**For more information on:**

- the XPression INcoder, including stopping the INcoder service, refer to the *XPression INcoder User Guide*.

## XPression INcoder Tasks

Use the XPression INcoder Manager to view the INcoder tasks.

### To view the INcoder tasks:

1. On the machine that has the XPression INcoder installed, locate the XPression INcoder folder using the **Start** menu.
2. Select **INcoder Manager**.

The XPression INcoder Manager opens on the **Tasks** tab.

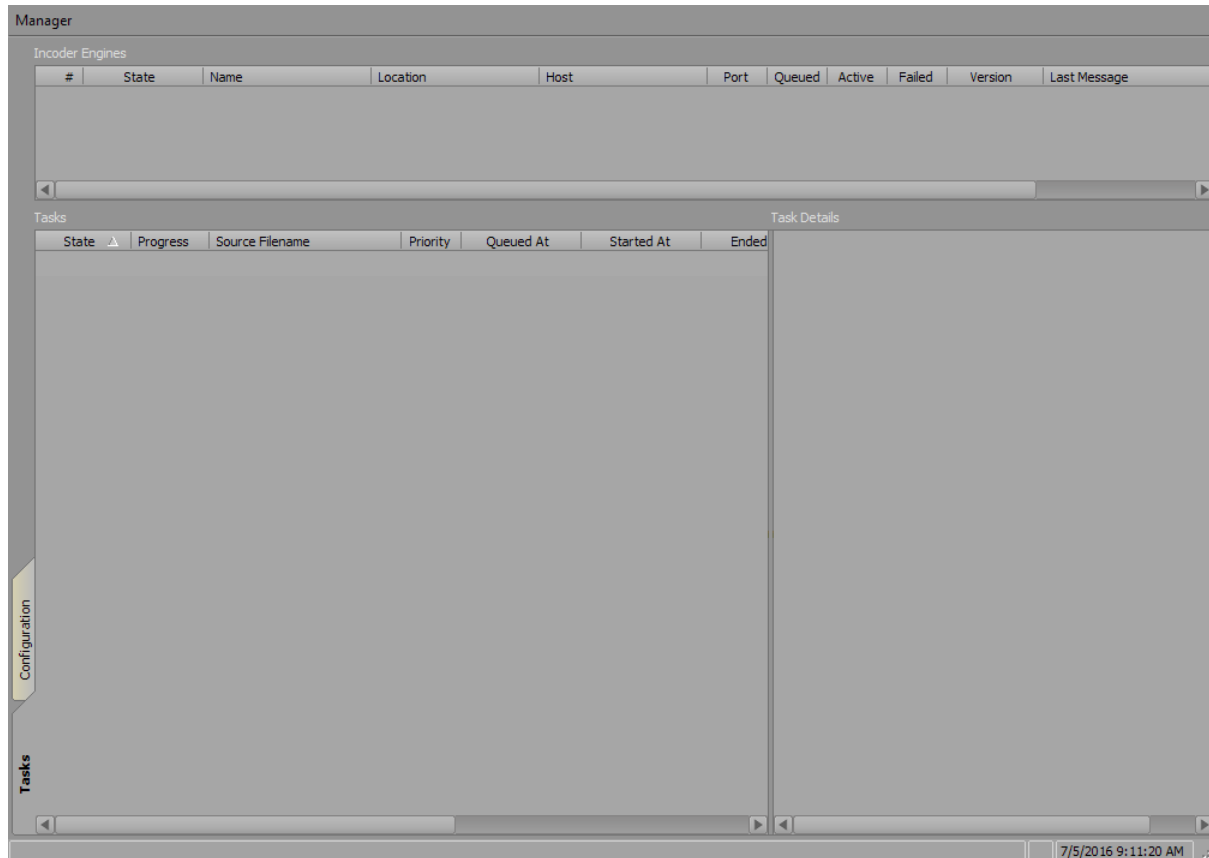

3. Add a video to the source folder.

The video appears in the **Tasks** list and the **State** is listed as **Transcoding**.

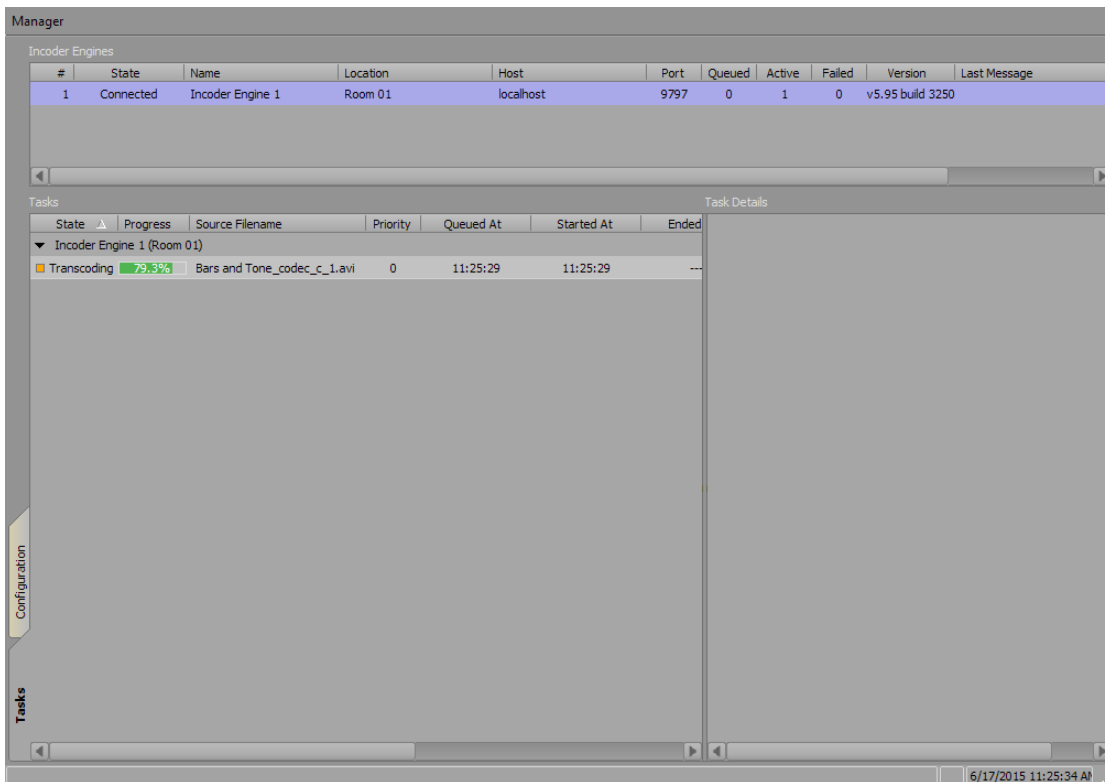

4. Once the video has finished transcoding, the **State** lists as **Finished** and the **Progress** displays at **100.0%**.

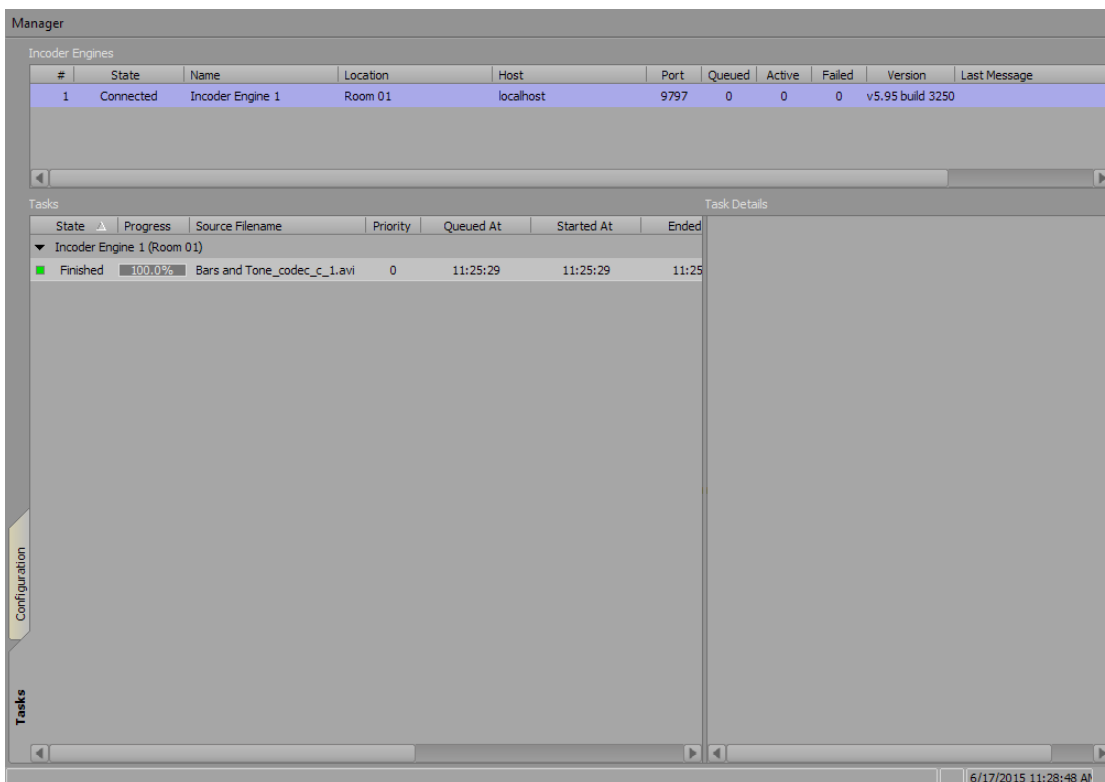

5. If the INcoder shows no tasks in the **Tasks** list once a video is added to the source folder, verify that the video type is supported.
6. If the video type is supported, stop and then restart the INcoder:

**To stop the INcoder:**

- Select **Stop INcoder** () from the Windows **Start** menu.

If the INcoder was successfully stopped, an information message indicates that the XPression INcoder was successfully stopped.

**To restart the INcoder:**

- Select **Start INcoder** () from the Windows **Start** menu.

If the INcoder has successfully started, an information message indicates that the XPression INcoder was successfully started.

## Task List Shortcut Menu - INcoder Engine

Right-click on an INcoder engine in the **Tasks** list to access the INcoder engine shortcut menu:

- **Remove > Completed** — remove completed clips from the Tasks list for the selected engine.
- **Remove > Failed** — remove failed clips from the **Tasks** list for the selected engine.
- **Remove > Cancelled** — remove cancelled clips from the **Tasks** list for the selected engine.

## Task List Shortcut Menu - Video

Right-click on a transcoded video in the **Tasks** list to access the video shortcut menu:

- **Set Priority** — set a priority level for the selected clip. The order of priority ranges from -5 (Lowest) to 0 (Normal) to +5 (High). The default is 0.
- **Remove** — remove the selected clip from the Tasks list.
- **Cancel** — cancel an in-progress transcoding of a clip.

# Using XPression Clips

The following topics are discussed in this section:

[Setting Up Server Channels](#)

[XPression Clips Playback Overview](#)

[Clip Browser Interface Overview](#)

[Using the Clip Browser](#)

[Server Channels](#)

[Edit Clip/Add Sub Clip](#)

[Updating the Thumbnail in the Clip Browser](#)

[Creating a 4-Point Loop](#)

[Creating a 3-Point Loop](#)

[Send a Video or Image to Clip Store Using the Record Client](#)

[Preset Event Tracks](#)

## Setting Up Server Channels

The **Server Channels** are used for previewing and playing out clips.

Before using the **Server Channels**, they must be configured in the XPression Hardware Setup. Once outputs have been configured in XPression, use the following procedure to set up the server channels.

A virtual channel should be assigned a real physical output onto which the clip will be played. It is these virtual channels that the AMP/VDCP Media Control Gateway is controlling.

This section contains the following information:

[Adding a Server Channel](#)

[Adding a Preview Output to a Server Channel](#)

### **For More Information on...**

- configuring outputs, refer to the *XPression User Guide* or **Help** file.

## Adding a Server Channel

1. In XPression, select **Edit > Hardware Setup**.

The **Hardware Setup** dialog opens.

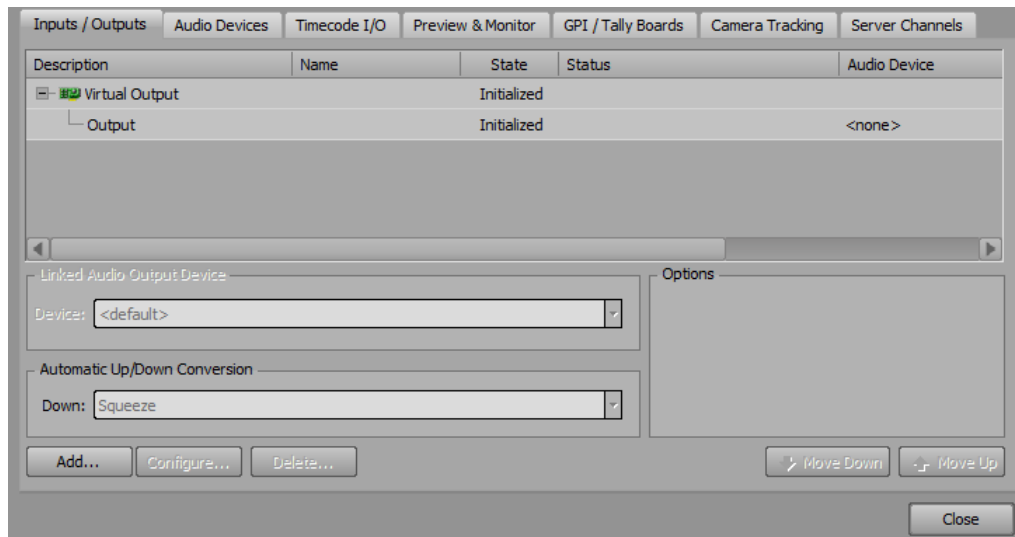

2. Select the **Server Channels** tab.

The **Server Channels** tab opens.

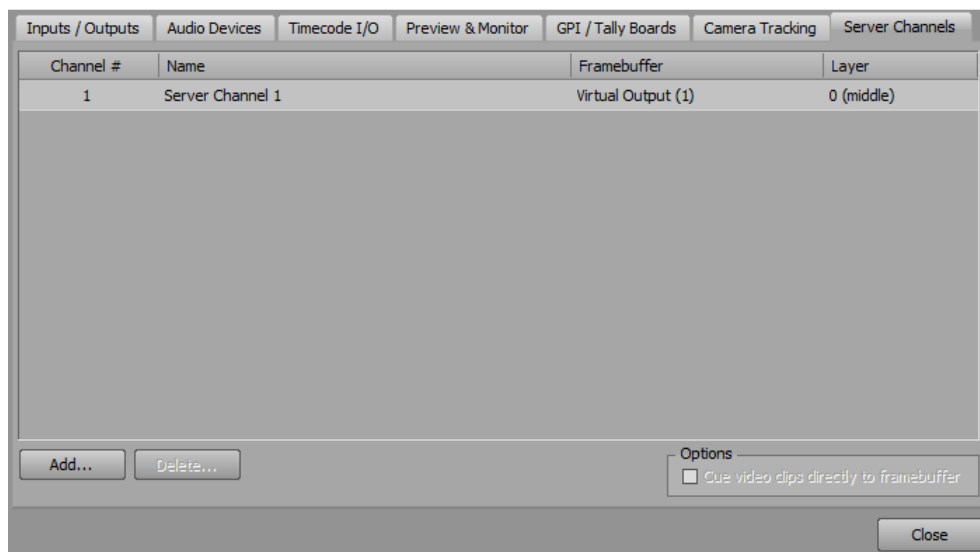

3. Select **Add** to add a server channel.

The **Select Server Channel #** dialog opens.

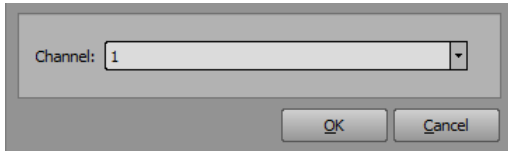

4. From the **Channel** drop-down, select a server channel number and select **OK**.

The server channel is added to the list.

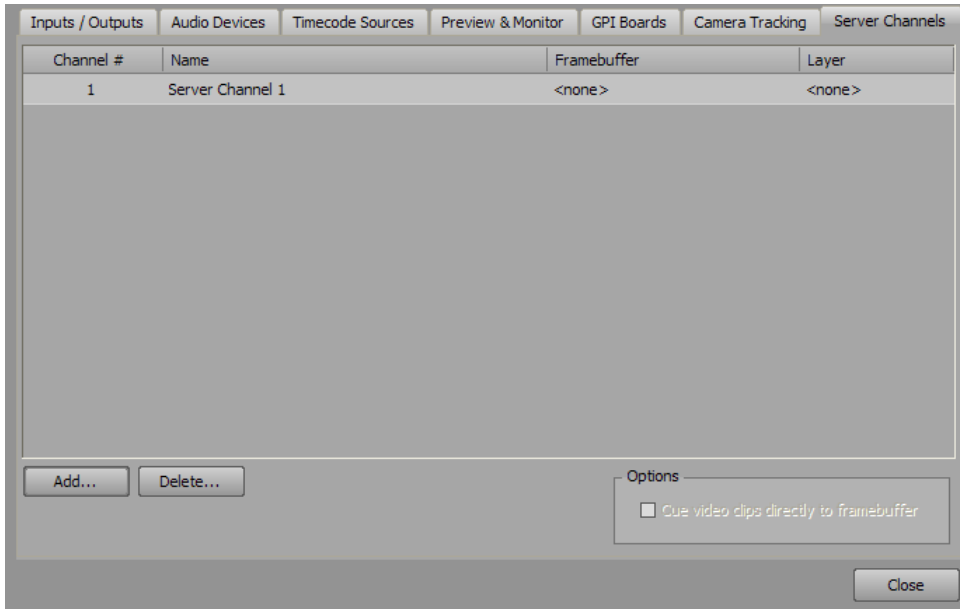

5. Configure the following as necessary:

- In the **Name** column, enter a name for the server channel.

The default is **Server Channel #**.

- In the **Framebuffer** column, use the list to select an output framebuffer for the server channel.
- In the **Layer** column, use the list to select a layer for rendering. The default is 0 (middle).
- In the **Server Channel # Options** section, select the Cue video clips directly to framebuffer check box to cue clips to air immediately when dropped on a server channel from the Clip Browser.

6. Repeat steps 3 to 5 to add more server channels as necessary.

7. Select **Close** to exit the **Hardware Setup** dialog.

## Adding a Preview Output to a Server Channel

Once a server channel has been created, it can be assigned a dedicated framebuffer as a preview channel in the Preview & Monitor tab of the Hardware Setup. Real outputs can also be used as framebuffers.

1. In XPression, select **Edit > Hardware Setup**.

The **Hardware Setup** dialog opens.

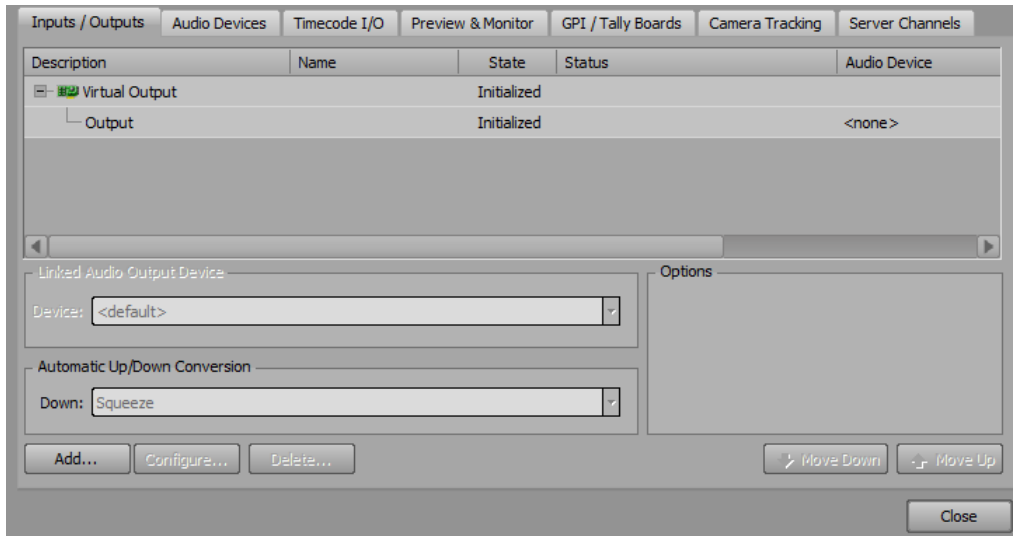

2. Select the **Preview & Monitor** tab.

The **Preview & Monitor** tab opens.

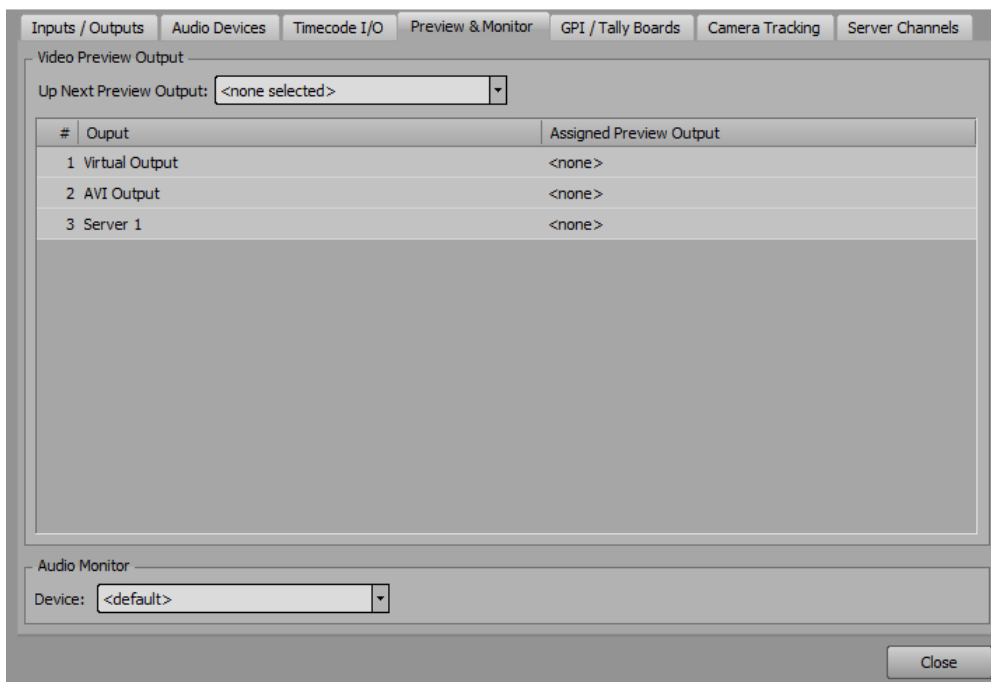

3. Select inside the **Assigned Preview Output** column of a server channel in the **Output** list and from the **Assigned Preview Output** drop-down, select a framebuffer as the individual preview output.

The selected framebuffer is assigned as the preview output of the selected server channel.

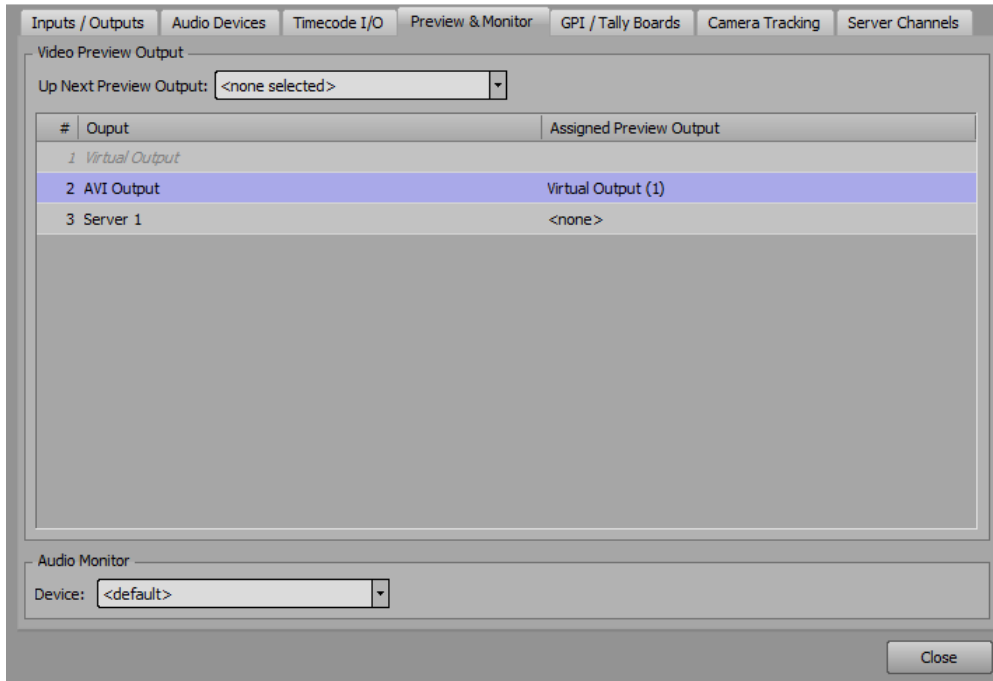

#### For More Information on...

- creating a server channel, refer to [Adding a Server Channel](#).

# XPression Clips Playback Overview

Clip playback within XPression can be performed in many ways. The most basic is to open the Clip Browser in the Sequencer and drag clips from the Clip Browser and drop them into the Sequencer. This creates a take item which can be assigned an output framebuffer and layer, or server channel and layer, and then played back as a regular take item or placed into a Cued state using the number pad period key [Num pad .].

Regular XPression graphics can be rendered as a clip which will be sent directly to the Clip Store. By right-clicking on a take item in the Sequencer and selecting **Export Take Item to Video**, the Export to Video dialog box will open and provide the option to render take items into clips transferred to the clip store.

The number of clips that can be played back simultaneously falls under the same performance limitations as normal XPression scenes with clips (e.g. play back will be dependent on current generation hardware).

While playing back, a timer counts down the remaining time in the clip and a time bar indicates the playback amount completed:

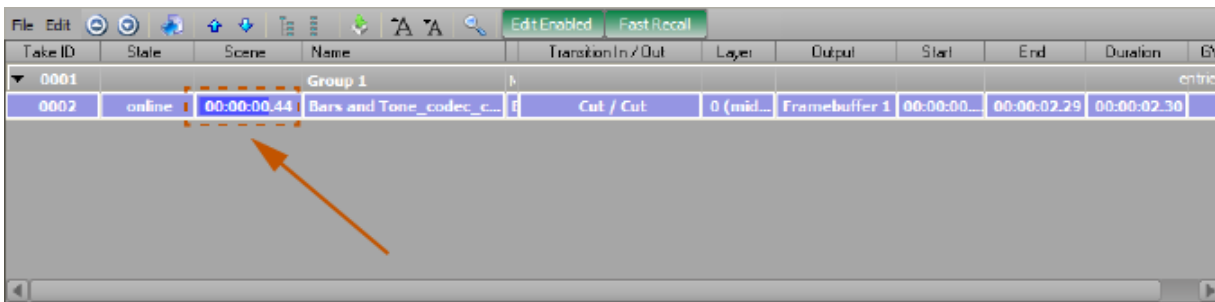

Many clips can be dragged into a timed sequence group for a pseudo-playlist capability. Dissolves can even be set on the take items for transitions between the playlist items:

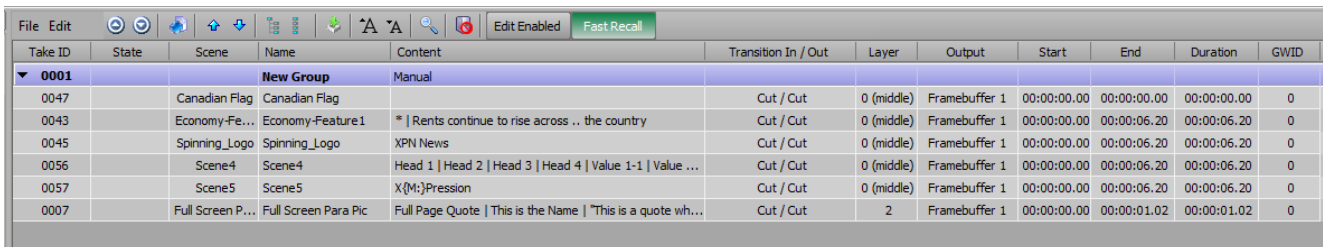

Clips within the Clip Browser can be sorted and filtered using the options in the Advanced Search Options. In the example image below they were filtered by Project Name:

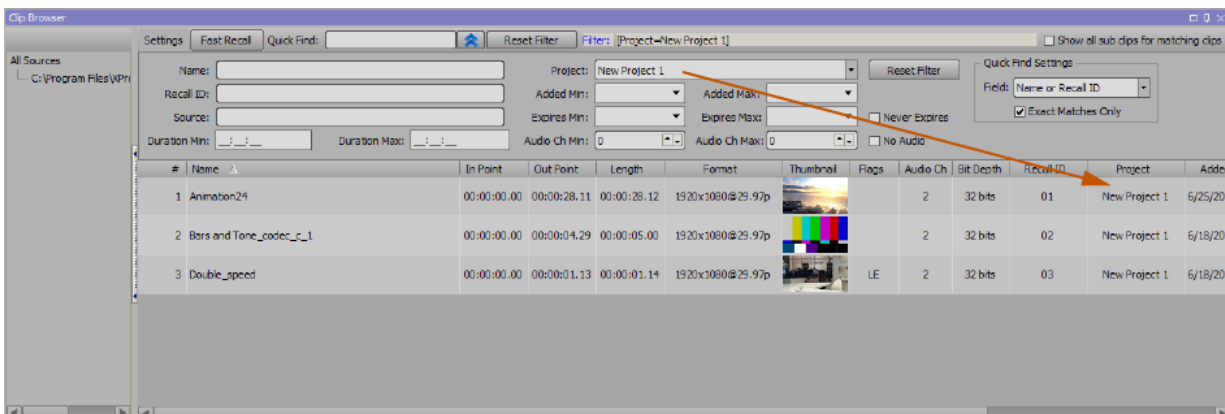

# Clip Browser Interface Overview

The following screen capture displays the main elements of the Clip Browser interface.

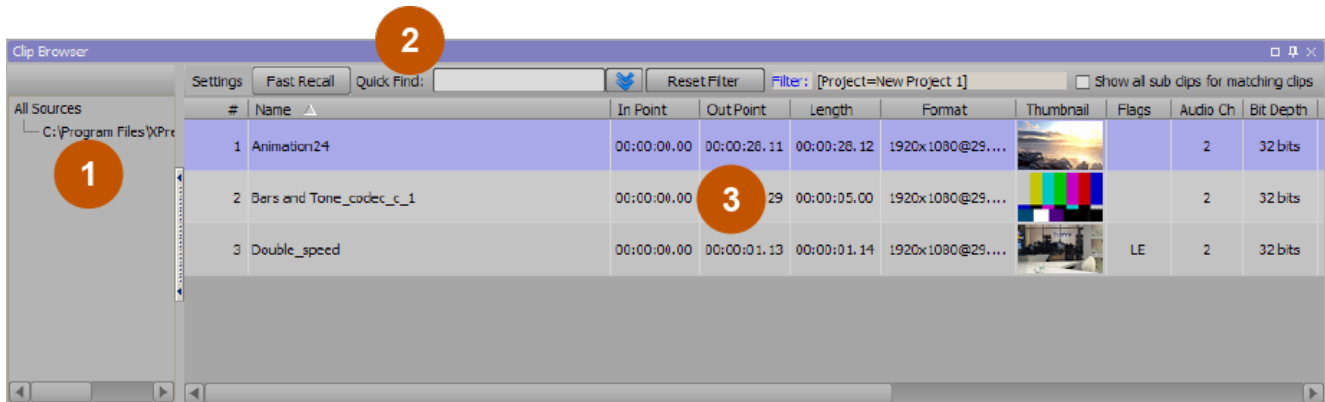

1. **Sources** — use this area to view and select clip sources.
2. **Quick Find/Search Area** — use this area to search for clips. It can be expanded for advanced search options.
3. **Clips List** — use this list to view the clips and their multiple properties, cue the clips to the server channels, edit clips, and add sub clips.

## Using the Clip Browser

The Clip Browser is used for dragging and dropping clips onto Server Channels or into the Sequencer as take items that can then be cued or played out on server channels (instead of a framebuffer). When dragging a clip into the Sequencer, the take ID assigned uses the recall ID or the next higher available number. The Clip Browser also allows for editing of clips.

If clips have been sent to the Clip Browser from the Record Client, or if clips have been transcoded by the INcoder into the Watch Folder, clips will automatically load into the Clip Browser.

The following topics are discussed in this section:

[Opening the Clip Browser](#)

[Clip Browser Interface](#)

## Opening the Clip Browser

If using the Clips Option for XPression, use the following procedure to open the Clip Browser.

### To open the Clip Browser:



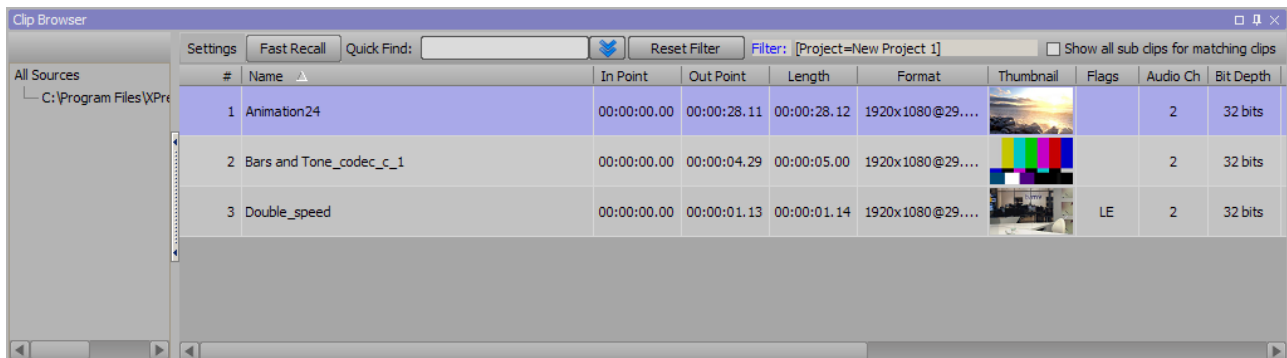

1. In XPression, select the **Sequencer** layout.
2. In the **Menu** bar, select **Display > Clip Browser**.

The **Clip Browser** opens.



## Clip Browser Interface

The following section describes the Clip Browser window interface.

<b>All Sources</b>	lists the Clip Store sources.
<b>Settings</b>	<p>select the following options:</p> <ul style="list-style-type: none"> <li>• <b>Increase Font Size</b> () — increase the font size of the Clip Browser list.</li> <li>• <b>Decrease Font Size</b> () — decrease the font size of the Clip Browser list.</li> <li>• <b>Timecode &gt; Use Source Timecode for In/Out points</b> — display the In/Out points relative to the timecode of the original source clip.</li> <li>• <b>Show Thumbnail Overlays</b> — overlay an icon on thumbnails of single frame clips in the Clip Browser to indicate that they are stills.</li> <li>• <b>Reset Columns to Default</b> — revert the Clip Browser columns to the default display settings.</li> </ul>
<b>Fast Recall</b>	enable or disable fast recall through the keyboard number pad (the button is green when turned on). The number pad Scroll Lock key can also be used to control fast recall.
<b>Quick Find</b>	enter keywords to search for clips listed in the Clip Browser.
<b>Show/Hide</b>  	show or hide the <a href="#">Advanced Search Options</a> in the Clip Browser.
<b>advanced search options</b>	
<b>Reset Filter</b>	clear any entries in the fields of the <b>Advanced Search Options</b> .
<b>Filter</b> (read-only)	displays the project selected in the <b>Advanced Search Options</b> .
<b>Show all sub clips for matching clips</b>	display any sub clips of a clip in the Clip Browser list.
<b>#</b> (read-only)	lists the number in the Clip Browser list.
<b>Name</b> (read-only)	lists the name of the clip.
<b>In Point</b> (read-only)	lists the drop frame timecode starting point for the clip.
<b>Out Point</b> (read-only)	lists the drop frame timecode ending point for the clip or still.
<b>Length</b> (read-only)	lists the drop frame timecode duration of the clip or still.
<b>Format</b> (read-only)	lists the formatting used for the clip.
<b>Thumbnail</b> (read-only)	provides a thumbnail image of the clip or still. Thumbnails can be enlarged by selecting and dragging the right border of the thumbnail column title. Review a flip book layout of the clip by hovering the cursor over the thumbnail. The flip book is rendered over a checkerboard pattern so that the alpha channel is visible unless the clip is full frame. Still image thumbnails display an icon (  ) indicating that they are still images and not clips.

<b>Flags</b> (read-only)	<p>if using clips that have been transcoded by the XPression INcoder that include tags in the filename, this column lists the tags that have been parsed from the filename of the clip. The possible flags include:</p> <ul style="list-style-type: none"> <li>• <b>LE</b> — indicates that looping has been enabled.</li> <li>• <b>HF</b> — indicates that the clip will hold the last frame.</li> <li>• <b>PM</b> — indicates that the clip uses premultiplied/shaped video.</li> </ul>
<b>Audio Ch</b> (read-only)	lists the amount of audio channels embedded in the clip.
<b>Bit Depth</b> (read-only)	lists the quality of the signal quantization for the clip.
<b>Recall ID</b> (read-only)	lists the ID number for the clip when it is recalled.
<b>Project</b> (read-only)	lists the name of the project to which the clip has been added.
<b>Added</b> (read-only)	lists the date the clip was added to the project.
<b>Expires</b> (read-only)	lists the expiry date for the clip, if applicable.
<b>Codec</b> (read-only)	lists the codec format of the clip.
<b>File Ext</b> (read-only)	lists the file type of the clip.
<b>Alpha</b> (read-only)	provides a thumbnail of the clip with the alpha channel visible (requires the original clip to be re-ingested or the thumbnail needs to be updated in the <a href="#">Edit Clip/Add Sub Clip</a> dialog box if the original status indicates <no info>).
<b>First Frame TC</b> (read-only)	lists the timecode at the point of the first frame of the clip.
<b>Volume</b> (read-only)	lists the volume level of the clip in decibels.

## Advanced Search Options

<b>Name</b>	enter the name of a clip to search.
<b>Recall ID</b>	enter a recall ID to search.
<b>Source</b>	enter a location to search for a clip.
<b>ID Min</b>	enter or select a minimum clip ID number to search.
<b>ID Max</b>	enter or select a maximum clip ID number to search.
<b>Duration Min</b>	enter a minimum duration time to search for the clip.
<b>Duration Max</b>	enter a maximum duration time to search for the clip.
<b>Project</b>	select a project to search for the clip.
<b>Added Min</b>	use the calendar to select a minimum date to search that the clip was added.
<b>Added Max</b>	use the calendar to select a maximum date to search that the clip was added.
<b>Expires Min</b>	use the calendar to select the minimum expiry date to search for the clip.
<b>Expires Max</b>	use the calendar to select the maximum expiry date to search for the clip.
<b>Never Expires</b>	search for a clip with no expiry date set.
<b>Audio Ch Min</b>	enter or select a minimum amount of embedded audio channels to search for the clip.
<b>Audio Ch Max</b>	enter or select a maximum amount of embedded audio channels to search for the clip.
<b>No Audio</b>	search for a clip with no embedded audio.
<b>Reset Filter</b>	clear all the fields in the <b>Advanced Search Options</b> .

## Clip Browser Shortcut Menu

Right-click on a clip in the Clip Browser to access the Clip Browser shortcut menu.

<b>Cue on Server Channel</b>	add the selected clip to the active (focused) server channel.
<b>Edit</b>	open the <b>Edit Clip</b> dialog and edit the settings of the selected clip.
<b>Add Sub Clip</b>	open the <b>Add Sub Clip</b> dialog and create a sub clip from the selected clip.
<b>Set Recall ID</b>	set the recall ID of a selected clip or a range of selected clips in the Clip Browser using the <b>Set Recall ID</b> dialog. Use the <b>Set Recall ID</b> dialog to enter a recall ID to assign to a selected clip or the starting recall ID for the range of selected clips. Using the keyboard shortcut <b>Ctrl + R</b> also opens the <b>Set Recall ID</b> dialog.
<b>Adjust Loop / Hold Last &gt; Enable Looping</b>	enable looping for a clip or a range of selected clips.
<b>Adjust Loop / Hold Last &gt; Disable Looping</b>	disable looping for the clip or a range of selected clips if looping is enabled.
<b>Adjust Loop / Hold Last &gt; Enable Hold Last Frame</b>	hold the last frame of the clip or a range of selected clips when playout ends. Do not select this function if taking the clip(s) offline automatically using an out transition.
<b>Adjust Loop / Hold Last &gt; Disable Hold Last Frame</b>	disable holding the last frame of the clip or a range of selected clips when playout ends if holding the last frame is already enabled.
<b>Add to Sequencer</b>	add selected clip or range of clips to the <b>Sequencer</b> .

### For More Information on...

- the **Edit Clip** dialog and **Add Sub Clip** dialog, refer to [Edit Clip/Add Sub Clip](#).

## Server Channels

The following screen capture displays the main elements of the Server Channels interface.

The Server Channels are used in the XPression Sequencer for previewing and playing out clips. The Server Channels also allow for editing of clips.

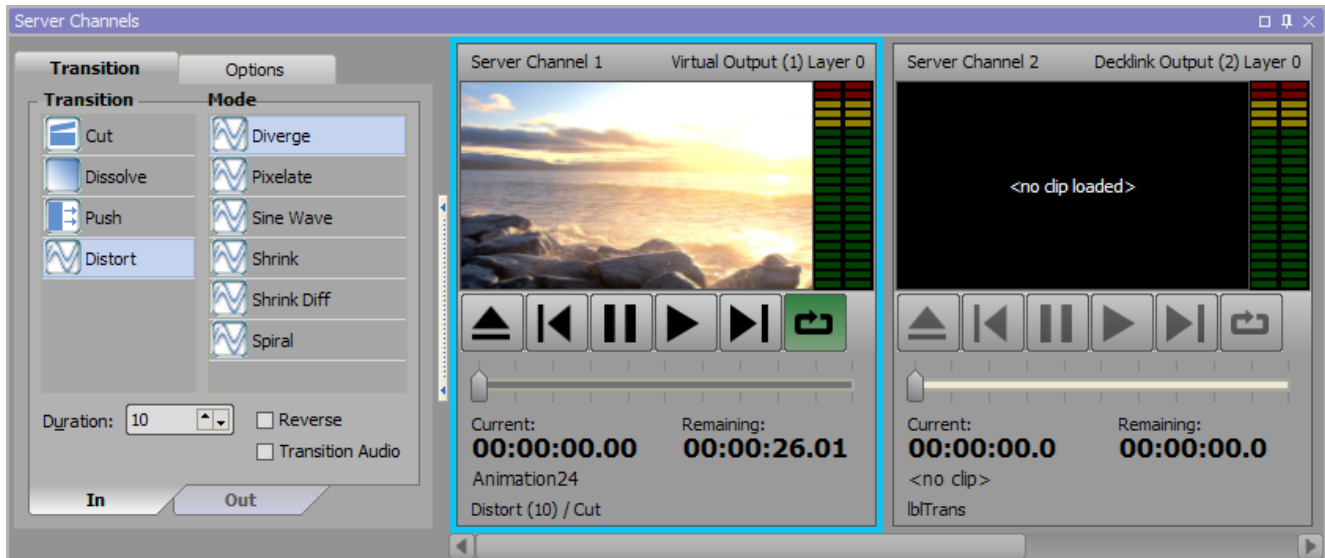

1. **Transitions / Options** — use this section to set the in and out transitions for the clip in the active server channel and configure the options for the active server channel.
2. **Preview** — use this window to preview a clip before playout.
3. **Server Channel** — use this window to view the loaded clip and audio monitors and use the playout controls to play, pause, skip forward, skip backward, loop, eject or move the position of the clip.

## Opening the Server Channels

If using the Clips Option for XPression, use the following procedure to access the Server Channels.

### To open the server channels:

1. In XPression, open the **Sequencer** layout.
2. In the **Menu** bar, select **Display > Server Channels**.

The **Server Channels** window opens.

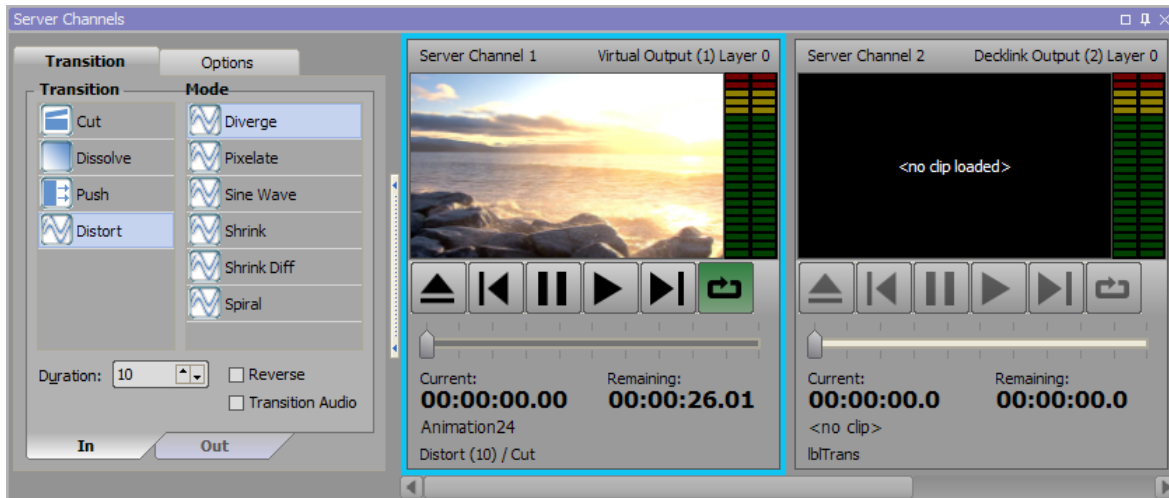

## Loading a Clip in the Server Channels

For clips to load in the **Server Channels** window, server channels must be configured in the **Server Channels** tab of the XPression **Hardware Setup**. See [Setting Up Server Channels](#).

**To load a clip in the server channels:**

1. In the **Clip Browser**, select a clip.

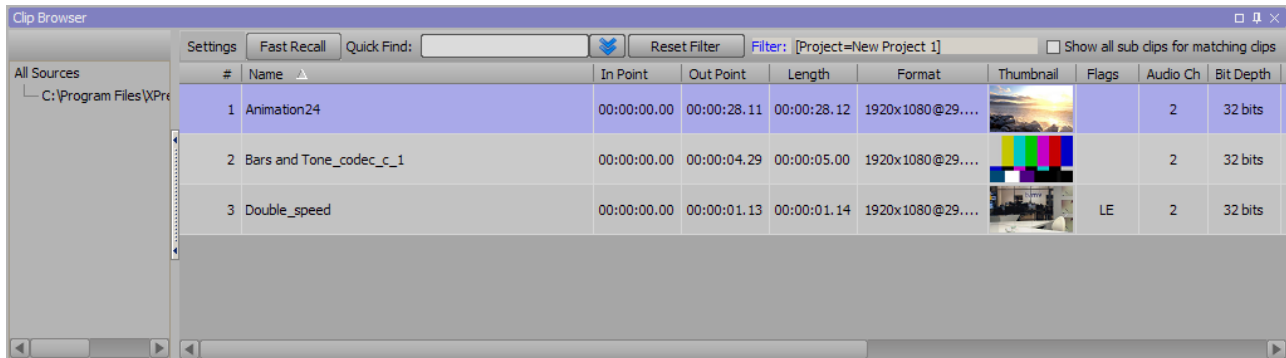

If clips have been sent to the Clip Browser from the **Record Client**, or if clips have been transcoded by the INcoder into the **Watch** Folder, clips will automatically load into the Clip Browser.

2. Drag and drop a clip from the Clip Browser onto a **Server Channel** in the **Server Channels** window.

The clip is added to the **Preview** channel for the **Server Channel** (or directly to the **Server Channel** if the preview has been disabled in the options).

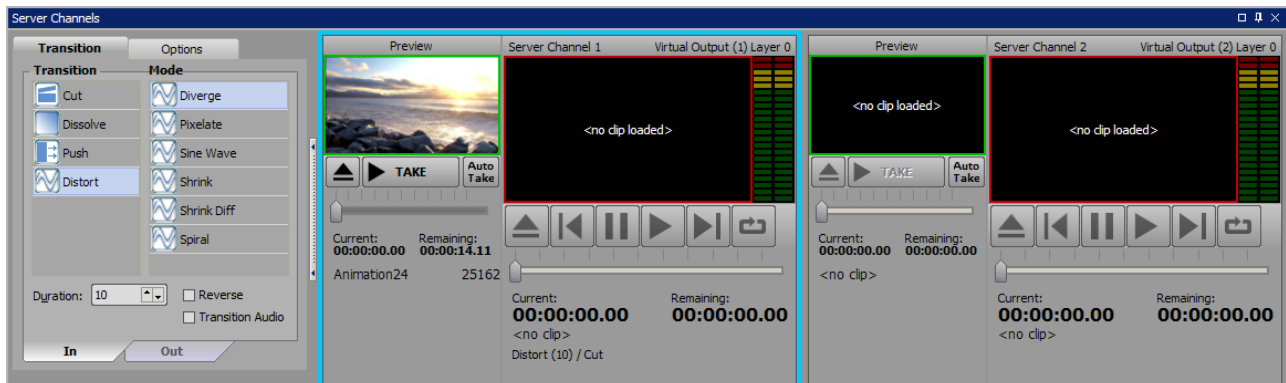

The clip will be loaded to its pre-configured in point.

3. If loaded in the **Preview**, select **Take** to play the clip on air on the **Server Channel**.

While a clip is on air, clips can be cued on the **Preview** channel while still allowing the on air clip to be controlled and have its timecode and countdown visible.

**Server Channel** playback controls are provided or the space bar can be used to pause and start playback.

A realtime proxy of the clip is shown as it plays in the server channel along with audio meters and a time remaining counter.

Take items or timed groups in the **Sequencer** can also be dragged onto a server channel for playback. To preserve the original server channel assignment of a take item, press and hold **Ctrl** while dragging and dropping from the **Sequencer** to a server channel.

★ Clips can also be loaded to a channel by double-clicking them in the Clip Browser. They will be loaded onto the active server channel, as shown by a cyan outline around the channel. Once a clip is loaded to a server channel, it can be dragged and dropped from one server channel to another as a duplicate. The active channel can be changed by double-clicking any other server channel.

Clips can also be dragged and dropped directly from Windows Explorer for situations where the clip is not loaded into the Clip Store (or there is no Clip Store present).

4. Select the **Transition** tab to set the in and out transitions for the clip in the active server channel:

5. In the **In** tab, select a **Transition** style and **Mode**:

The options are:

- **Cut** — select to use an instantaneous transition from the take item to the next take item.
- **Dissolve** — select to use a gradual transition where a take item dissolves into the next take item.

Configure the mode for the dissolve:

- **Fade** — select to fade in to, or out from, the clip.
- **Over Black** — select to fade in or out from black.
- **Additive** — select to gradually add light to the clip when transitioning in or out.
- **Saturate** — select to saturate the clip when transitioning in or out.
- **Desaturate** — select transition to desaturate the clip when transitioning in or out.
- **Invert** — select to invert the clip when transitioning in or out.

- **Push** — select to use a sliding transition where the take item pushes out the previous take item.

Configure the mode for the push:

- **Right To Left** — select to push from right to left.
- **Left To Right** — select to push from left to right.
- **Top To Bottom** — select to push from top to bottom.
- **Bottom To Top** — select to push from bottom to top.
- **Bottom Right** — select to push to the bottom right.
- **Top Right** — select to push to the top right.
- **Bottom Left** — select to push to the bottom left.
- **Top Left** — select to push to the top left.

- **Distort** — select to use a transition where a take item is warped out.

Configure the mode for the distortion:

- **Diverge** — select to use multiple splits in the image in the clip.
- **Pixelate** — select to pixelate the clip.
- **Sine Wave** — select to apply a sine wave pattern to the clip.
- **Shrink** — select to expand the clip from a shrunken image.
- **Shrink Diff** — select to expand the clip from a shrunken image.
- **Spiral** — select to spin the clip.

6. Select the **Reverse** checkbox to reverse a **Dissolve**, **Push**, or **Distort** transition.
7. Select the **Transition Audio** checkbox to transition the audio along with the **Take Item**.
8. Use the **Duration** field to enter or select the duration of the transition in number of frames.
9. Select the **Out** tab and repeat steps 5 to 7 to configure the **Transition** style and **Mode** for the out transition.
10. Select the **Cue video clips directly to framebuffer** checkbox to cue clips to air immediately when dropped on a server channel from the Clip Browser or Sequencer.

## Using the Server Channels

### To use the server channels:

1. In the **Server Channels** window, load a clip onto a **Server Channel**.

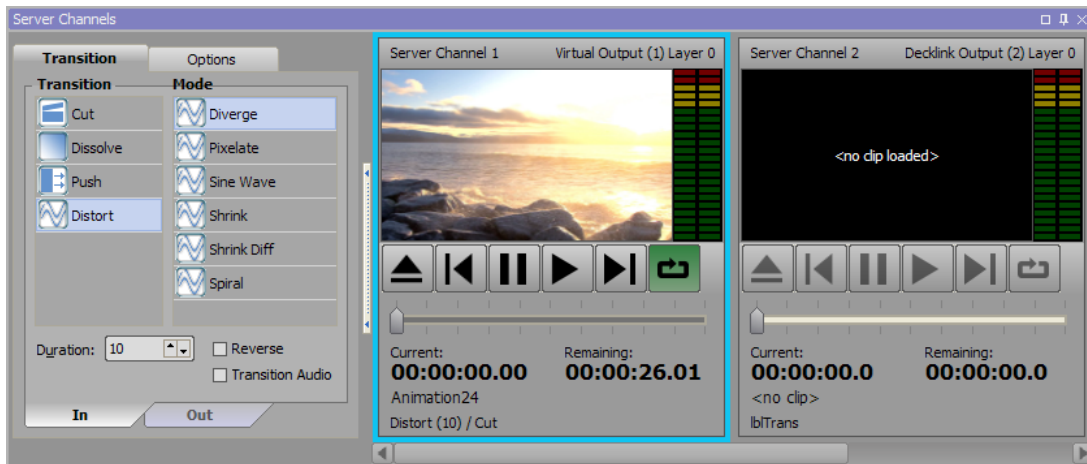

2. Select the **Transition** tab and configure the in and out transition for the clip:

In the **In** and **Out** tabs, select an in and out transition for the clip:

- **Cut** — transition instantaneously to and from the clip.
- **Dissolve** — the clip gradually dissolves in or out.
- **Push** — the clip slides in or out.
- **Distort** — the clip is warped in or out.

3. In the **Mode** section, configure the **Dissolve**, **Push**, and **Distort** transition mode:

#### Dissolve

- **Fade** — fade in to, or out from, the clip.
- **Over Black** — fade in or out from black.
- **Additive** — gradually add light to the clip when transitioning in or out.
- **Saturate** — saturate the clip when transitioning in or out.
- **Desaturate** — desaturate the clip when transitioning in or out.
- **Invert** — invert the clip when transitioning in or out.

#### Push

- **Right To Left** — push from right to left.
- **Left To Right** — push from left to right.
- **Top To Bottom** — push from top to bottom.
- **Bottom To Top** — push from bottom to top.
- **Bottom Right** — push toward the bottom right.
- **Top Right** — push toward the top right.
- **Bottom Left** — push toward the bottom left.
- **Top Left** — push toward the top left.

## Distort

- **Diverge** — use multiple splits in the image in the clip.
  - **Pixelate** — pixelate the clip.
  - **Sine Wave** — apply a sine wave pattern to the clip.
  - **Shrink** — expand the clip from a shrunken image.
  - **Shrink Diff** — expand the clip from a shrunken image.
  - **Spiral** — spin the clip.
  - **Duration** — enter or select the duration of the transition in number of frames.
4. Select the **Reverse** checkbox to reverse a **Dissolve**, **Push**, or **Distort** transition.
  5. Select the **Transition Audio** checkbox to transition the audio along with the **Take Item**.
  6. Use the **Duration** field to enter or select the duration of the transition in number of frames.
  7. In the **Options** tab, select the **Cue video clips directly to framebuffer** checkbox to cue clips to air immediately when dropped on a server channel from the **Clip Browser** or **Sequencer**.
  8. Use the playback controls to play out the clip:



**Eject** remove a loaded clip from the server channel.



**Back** return to the beginning of a clip.



**Pause** pause the clip.



**Play** play out the clip.



**Forward** go to the end of the clip.





**Loop** continuously play the clip. When this button is green, the loop function is turned on. Pressing it again will turn off the loop function.

**Scrub Bar** select and hold the marker to drag it forward or backward along the time bar to move the clip position to a particular location.

9. Right-click inside the **Server Channel** and:
  - select **Adjust Clip Volume** to open the **Adjust Clip Volume** dialog box and adjust the clip volume, if necessary.
  - select **Edit Clip** to open the **Edit Clip** dialog and edit a clip, if necessary.
  - select **Show Viewport** to open a separate server channel window.



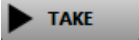



## Preview

The following section describes the Server Channels preview controls.

<b>Preview</b> (read-only)	displays the image thumbnail for the loaded clip.
 <b>Eject</b>	remove a loaded clip from the preview channel.
 <b>Take</b>	take the clip on air over the server channel and remove it from the preview channel.
 <b>Auto Take</b>	automatically take a clip cued on the preview channel when the on air clip has finished playing. This button is green when the auto take function is on.
<b>Scrub Bar</b>	select and hold the marker to drag it forward or backward along the time bar to move the clip position to a particular location.
<b>Current</b> (read-only)	displays the elapsed time of the clip.
<b>Remaining</b> (read-only)	displays the time remaining in the clip.
<b>Clip Name</b> (read-only)	displays the name of the clip loaded in the preview channel.
<b>Recall ID</b> (read-only)	displays the recall ID of the clip loaded in the preview channel.

## Server Channels

**Server Channel X** (read-only) — displays the output configured for the server channel, the selected layer, the image thumbnail for the loaded clip, and an audio meter.

 <b>Eject</b>	remove a loaded clip from the server channel.
 <b>Back</b>	return to the beginning of the clip.
 <b>Pause</b>	pause the clip.
 <b>Play</b>	play out the clip.
 <b>Forward</b>	go to the end of the clip.
 <b>Loop</b>	continuously play the clip. When this button is green, the loop function is turned on. Selecting it again will turn off the loop function.
<b>Scrub Bar</b>	drag the marker forward or backward along the time bar to move the clip position.
<b>Current</b> (read-only)	displays the elapsed time of the clip.
<b>Remaining</b> (read-only)	displays the time remaining in the clip.
<b>Clip Name</b> (read-only)	displays the name of the clip loaded in the server channel.

**Recall ID** (read-only) displays the recall ID of the clip loaded in the server channel.

**Transition** (read-only) displays the transition applied to the server channel.

### Server Channels Shortcut Menu

Right-click on a clip in the Server Channels to access the Server Channels shortcut menu.

**Adjust Clip Volume** — select this to open the Adjust Clip Volume dialog box and adjust the volume of the clip in decibels. Adjusting the volume of a clip on a server channel will adjust the volume of the clip in the ClipStore.

**Edit Clip** — select this to open the Edit Clip dialog box and edit the settings of the selected clip.

#### For More Information on...

- the **Edit Clip** dialog, refer to [Edit Clip/Add Sub Clip](#).

## Edit Clip/Add Sub Clip

Use the **Edit Clip** and **Add Sub Clip** dialogs to configure metadata for a clip. The **Add Sub Clip** dialog has the same interface as the **Edit Clip** dialog but is used to create a trimmed clip from an existing clip. A video can have multiple sub-clips defined within it, each with distinctive in/out points. Loading a sub-clip for playback is identical to loading a normal clip.

- The **Edit Clip** dialog can be accessed by right-clicking in the **Clip Browser** window and **Server Channels** window.
- The **Add Sub Clip** dialog can only be accessed by right-clicking in the **Clip Browser** window.

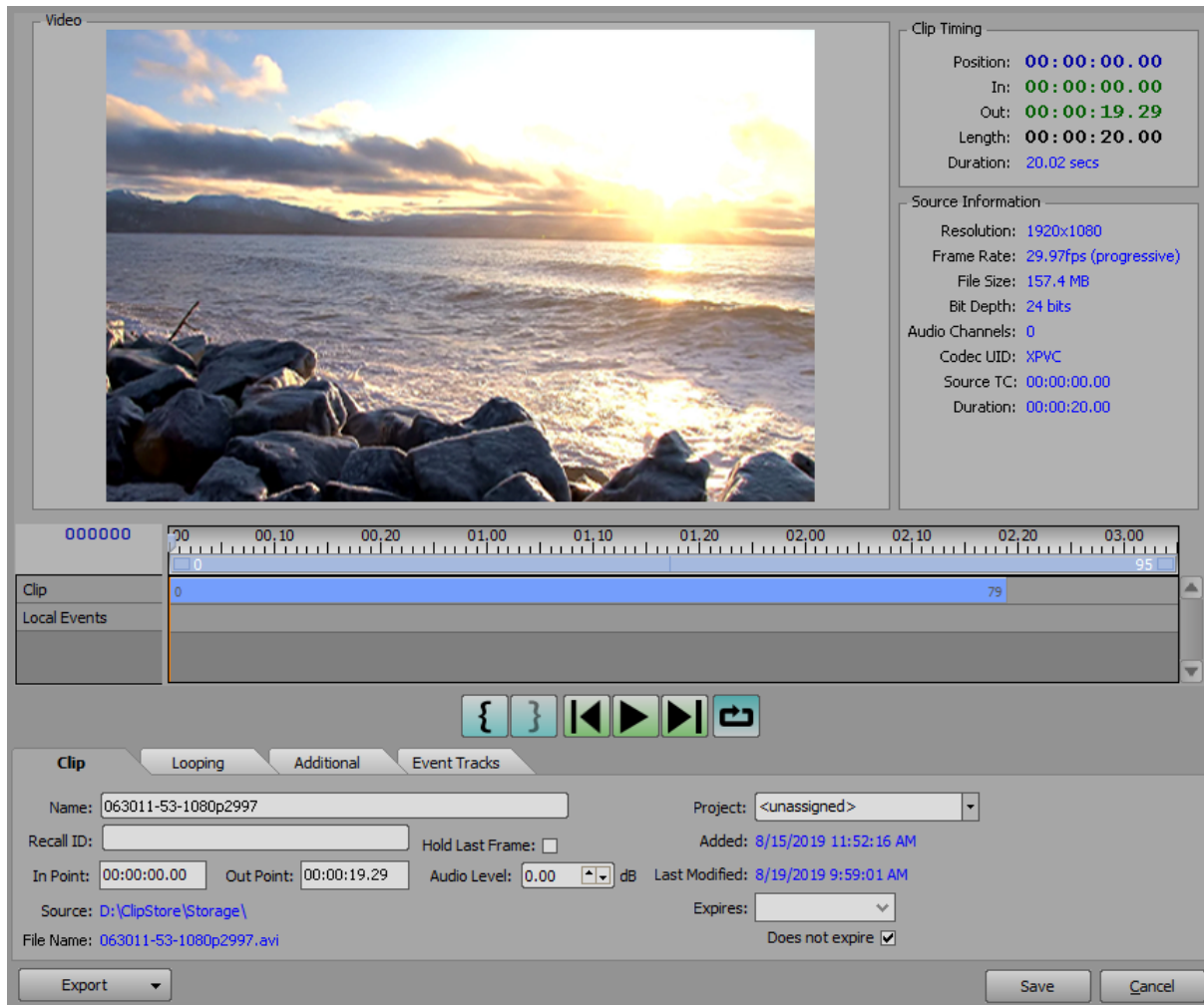

## Video

This section displays the clip that has been selected for editing or creating a sub clip. The clip is rendered over a checkerboard pattern so that the alpha channel is visible unless the clip is full frame.

The following actions and commands can be performed:

- Use the timeline marker to select a specific frame in the timeline.
- The video can be scrubbed using the timeline bar; or using common NLE shortcuts like H,J,K to play/rewind at different speeds.
- During scrubbing, audio can be heard by configuring an **Audio Monitor** device in the **Hardware Setup**.
- Right-click inside the **Clip**, **Local Events**, or **Event Track** timeline to access the shortcut menu.
  - ★ Event Track timelines are available if global event tracks have been configured in the **Clip Store Manager** and added as a processor in the **INcoder**. They will appear in the timeline as named in the **Clip Store Manager**. They can be assigned as local events by selecting **Preset Event Track > Copy Events to Local Event Track** from the shortcut menu.
  - **Looping > Set Loop Start** — select the current position of the timeline marker as the start of the video loop.
  - **Looping > Set Loop End** — select the current position of the timeline marker as the end of the video loop.
  - **Looping > Reset Loop** — clear the loop settings.
  - **Clear In Point** — clear a configured start time for the clip.
  - **Clear Out Point** — clear a configured end time for the clip.
  - **Clear In and Out Points** — clear the configured start and end times for the clip.
  - **Update Clip Thumbnail** — update the thumbnail for the clip to reflect any edits or to use a specific frame as the thumbnail in the Clip Browser.
  - **Add Event > Rosstalk Event** — add a RossTalk event directly onto the clip timeline.
  - **Add Event > Scene Director Trigger** — add a Scene Director trigger event directly onto the clip timeline.
  - **Rename Event** — rename a selected RossTalk or Scene Director trigger event on the clip timeline.
  - **Delete Event** — delete a selected RossTalk or Scene Director trigger event on the clip timeline.

## Video Controls



### **Set In Point**

set the start time of the clip where the timeline marker has been positioned. Keyboard shortcut 'I' can be used to mark an in point.



### **Set Out Point**

set the end time of the clip where the timeline marker has been positioned. Keyboard shortcut 'O' can be used to mark an out point.



### **Move current position to in point**

return to the in point of the clip.



### **Start playback**

play the clip.



### **Move current position to end point**

go to the end of the clip.



### **Loop**

loop the playback of the clip. Press the button a second time to turn off looped playback.

### **For More Information on...**

- looping, refer to [Looping Tab](#).

## Clip Timing (read-only)

**Position** — indicates the position of the timeline marker in the timeline for the clip.

**In** — displays the in point for the clip.

**Out** — displays the displays the out point for the clip.

**Length** — displays the total duration of the clip in frames.

**Duration** — displays the time length of the clip.

## Source Information (read-only)

**Resolution** — displays the video format of the source clip.

**Frame Rate** — displays the frame rate of the source clip.

**File Size** — displays the file size of the source clip.

**Bit Depth** — displays the quality of the signal quantization of the source clip.

**Audio Channels** — displays the amount of embedded audio channels used in the source clip.

**Codec UID** — displays the type of encoding used for the source clip.

**Source TC** — displays the timecode of the source clip.

**Duration** — displays the total duration in frames of the source clip.

## Clip Tab

**Name** — enter or edit a name for the clip.

**Recall ID** — enter an ID number for the clip when it is recalled.

**Hold Last Frame** — hold the last frame of the clip when playout ends. Do not select this checkbox if taking the clip offline automatically using an out transition.

**In Point** — enter a starting point for the clip.

**Out Point** — enter an ending point for the clip.

**Audio Level** — enter or select a volume level for the clip in decibels. Changing the audio level in the Edit Clip dialog box will not affect live clips on a Server Channel. However, it will apply to the audio monitor if an audio monitor is configured in the Hardware Setup.

**Source (read-only)** — lists the location where the clip is stored.

**File Name (read-only)** — lists the name and file extension of the clip.

**Project** — select a project for the clip.

**Added (read-only)** — lists the date the clip was added to the clip store.

**Last Modified (read-only)** — lists the date the clip was last edited.

**Expires** — use the calendar to select an expiry date for the clip, if necessary.

**Does not expire** — use no expiry date for the clip.

## Looping Tab

**Enable Looping** — enable looping for the clip.

**Multi-Point** — enable the multi-point loop settings.

### Multi-Point Loop Settings

Use the multi-point loops to create free running 4-point and 3-point loops:

- 4-point loops use a frame in point, a loop section of start and end frames, and a frame out point.
- 3-point loops use a loop section of start and end frames with either a frame in point the same as the loop start frame or a frame out point the same as the loop end frame.

**Loop Start**      enter a starting frame for the loop within the clip time.

**Loop End**      enter an end frame for the loop within the clip time.

**Loop Count**    enter or select an amount of playbacks the clip will loop before stopping. Use 0 for infinite looping.



Mark

set the start time or end time of the loop at the position of the timeline marker.

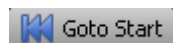

Goto Start

skip to the start of the loop.



Goto End

skip to the end of the loop.

### For More Information on...

- creating a 4-point loop, refer to [Creating a 4-Point Loop](#).
- creating a 3-point loop, refer to [Creating a 3-Point Loop](#).

## Additional

**Original File Name (read-only)** — displays the original name of the file as uploaded.

**Premultiplied / Shaped** — select this check box to multiply/shape the fill signal color information by the luminance information in the key signal.

## Event Tracks

Event tracks are configured in the Clip Store Manager, added as processors in the INcoder, and then available to use when editing clips from the Clip Browser. The Event Tracks tab provides a list of available global event tracks.

**Assigned Event Tracks** — lists the event tracks assigned to the clip.

**Available Event Tracks** — lists the available event tracks that can be assigned to the clip.

**Add Track** — select an available event track and select this button to assign it to the clip.

**Remove Track** — select an assigned event track and select this button to remove it from the clip.

### For More Information on...

- using global event tracks, refer to the *XPression Clips Workflow User Guide*.

## Other

**Export** — use this list to select one of the following options for exporting a clip:

- **To Video** — open the **Export to Video** dialog to save the clip as an AVI or MOV video file.
- **Still to Disk** — open a save dialog to save a still as a Targa (.TGA), Targa (RLE Compressed) (.TGA), Portable Network Graphic (.PNG), or JPEG (.JPG) format image file.
- **Still to Clipstore** — open the **Send to Clip Store** dialog to send a still to the Clip Store database to be used within the Clips workflow.
- **Interlaced Settings > Frame Based** — capture the image file without deinterlacing. This setting works best for scenes with minimal motion.
- **Interlaced Settings > Field (line doubled)** — capture the image file with each line doubled. For example, it will replace field two with a duplicate of field one.
- **Interlaced Settings > Field (line interpolated)** — capture the image file by interpolating between odd lines to form even lines.

**Save** — save the edited clip or sub clip.

**Cancel** — exit the dialog without saving any changes.

### For More Information on...

- the **Export to Video** dialog, refer to the *XPression Help* file.
- opening the Edit Clip window and the Add Sub Clip window from the Clip Browser, refer to [Clip Browser Shortcut Menu](#).
- opening the Edit Clip window from the Server Channels, refer to [Server Channels Shortcut Menu](#).

## Updating the Thumbnail in the Clip Browser

You can update the thumbnail in the **Clip Browser** to provide a more representative or preferred image to illustrate the content of the clip.

1. In the **Clip Browser**, right-click on a clip and select **Edit Clip** or **Add Sub Clip**.

The **Edit Clip / Add Sub Clip** dialog opens.

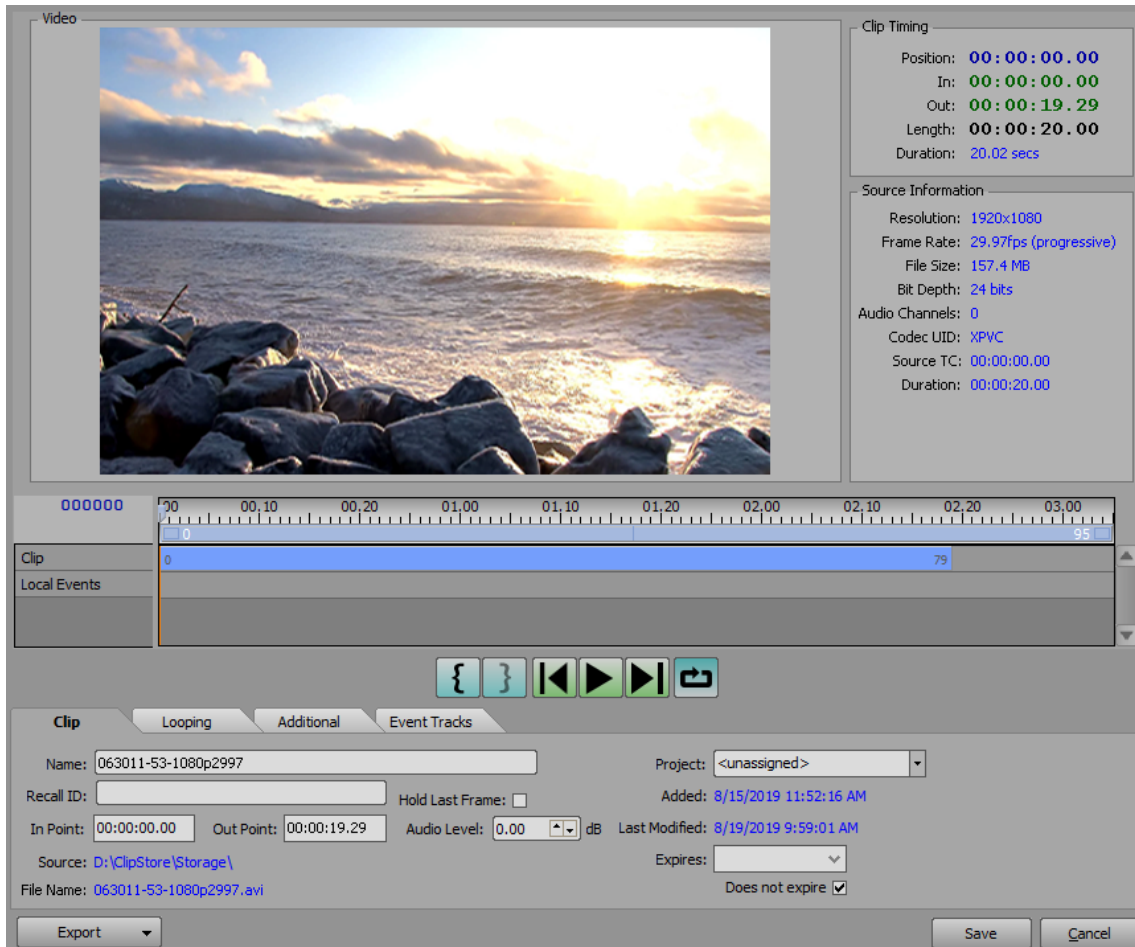

2. In the **Edit Clip** or **Add Sub Clip** dialog, move the timeline marker to a desired frame in the timeline.

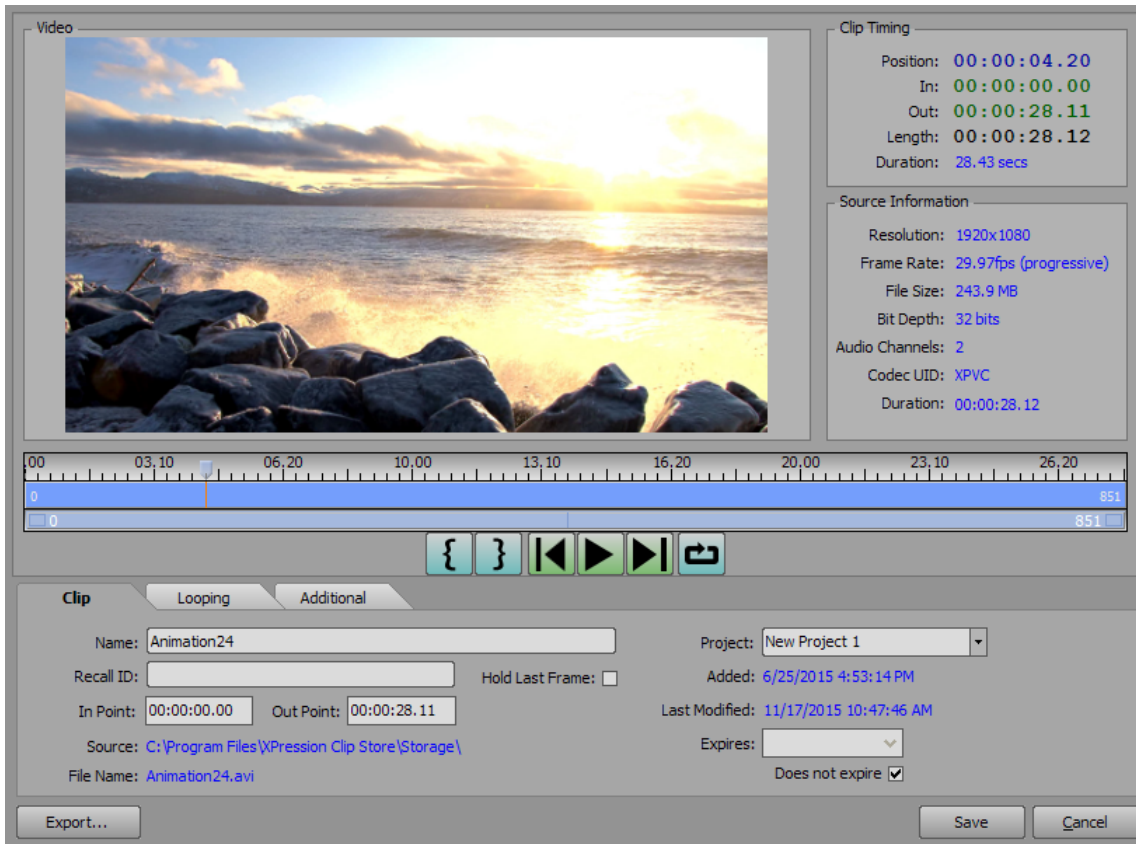

3. Right-click inside the timeline and select **Update Clip Thumbnail** from the shortcut menu.

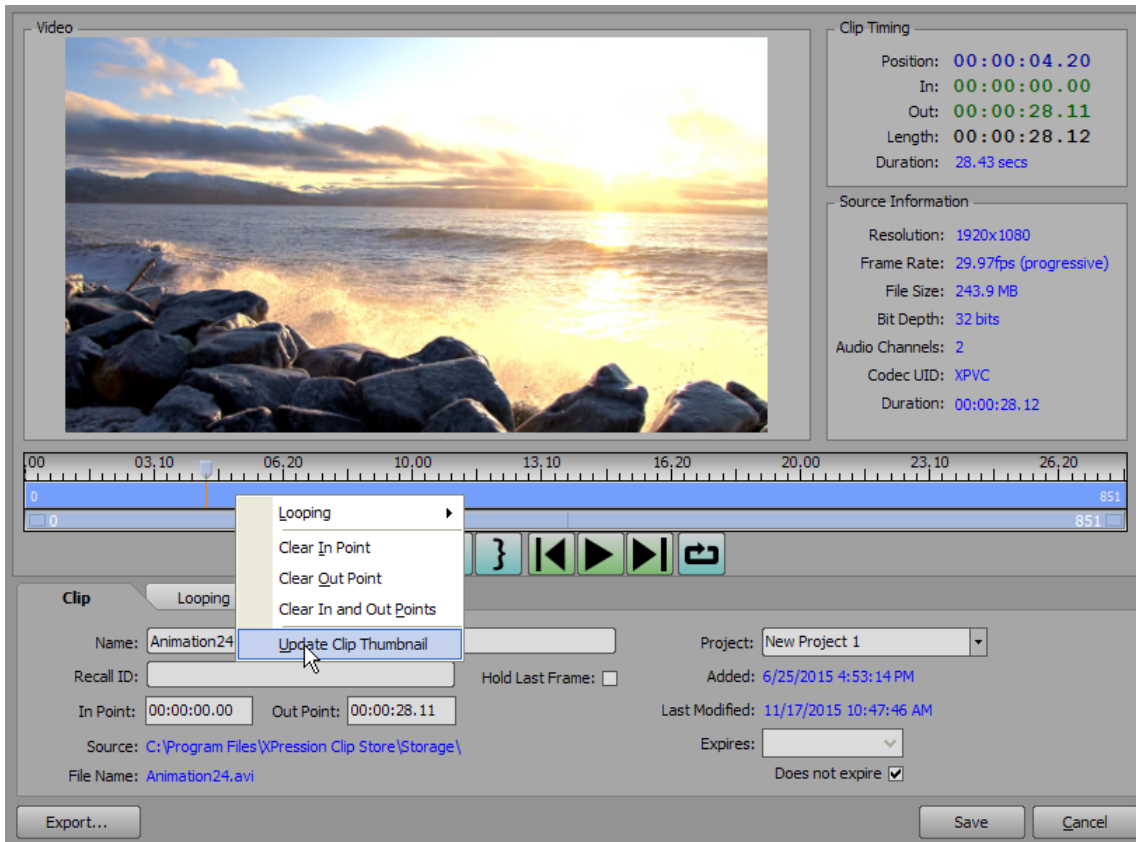

4. Select **Save**.

The thumbnail for the clip is updated in the **Clip Browser**.

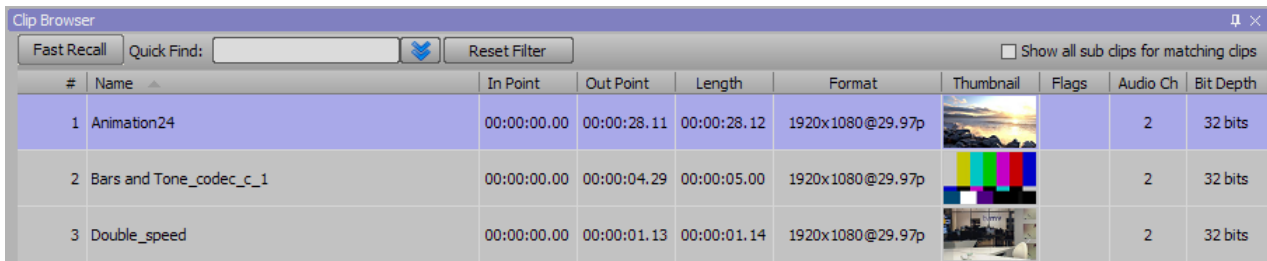

## Creating a 4-Point Loop

4-point loops use a frame in point, a loop section of start and end frames, and a frame out point.

### To create a 4-point loop:

1. In the **Edit Clip / Add Sub Clip** dialog, select the **Clip** tab.

The **Clip** tab opens.

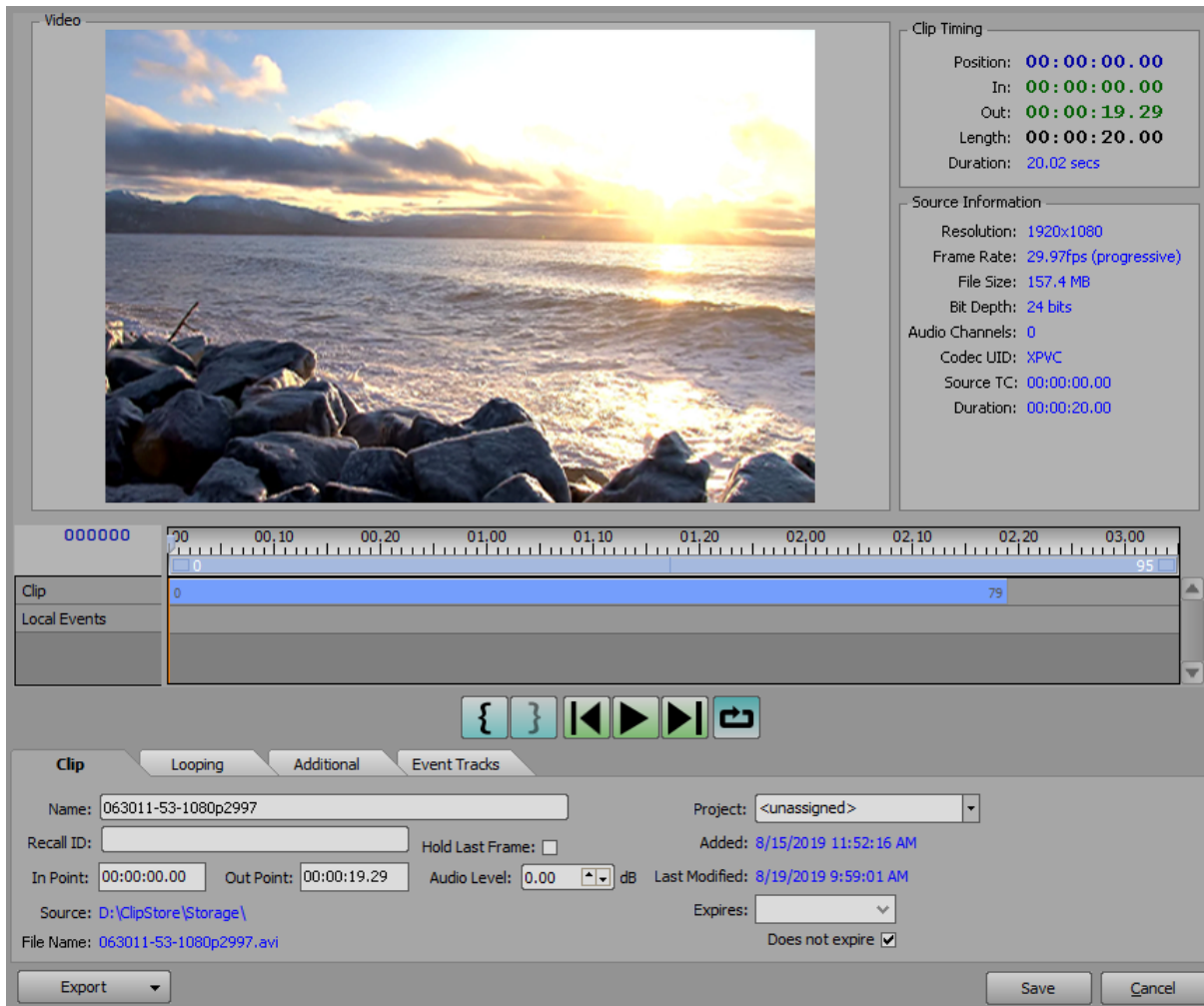

2. In the **In Point** field, enter a frame in point.
3. In the **Out Point** field, enter a frame out point.

4. Select the **Looping** tab.

The **Looping** tab opens.

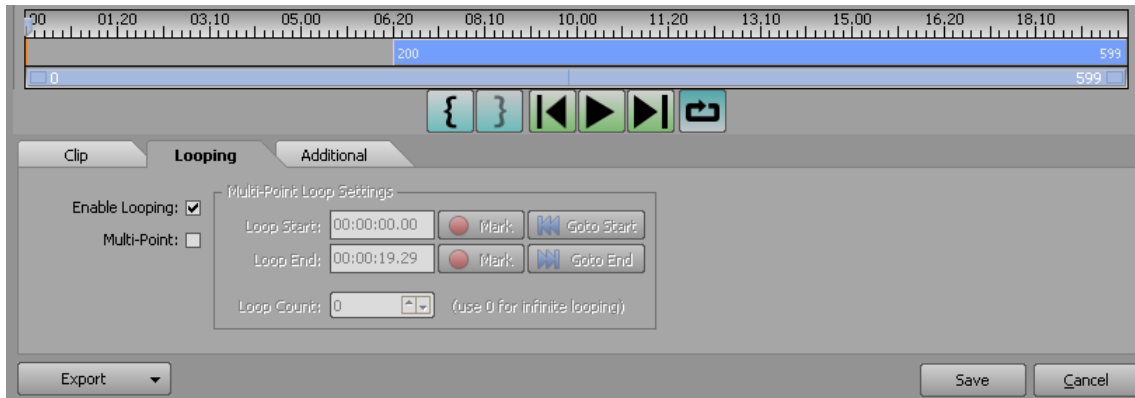

5. In the **Looping** tab, select the **Enable Looping** checkbox.

6. Select the **Multi-Point** checkbox.

7. In the **Multi-Point Loop Settings** section:

- In the **Loop Start** field, enter a frame start for the loop.
- In the **Loop End** field, enter a frame stop for the loop.
- In the **Loop Count** field, enter or select the number of times to play out the loop. Enter **0** for infinite looping.

8. Select **Save**.

The edited clip is updated in the **Clip Browser**.

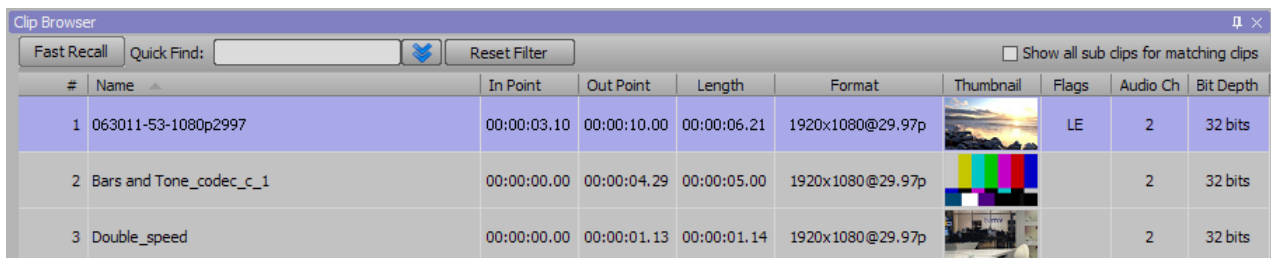

## Creating a 3-Point Loop

3-point loops use a loop section of start and end frames with either a frame in point the same as the loop start frame or a frame out point the same as the loop end frame.

### To create a 3-point loop:

1. In the **Edit Clip / Add Sub Clip** dialog, select the **Clip** tab.

The **Clip** tab opens.

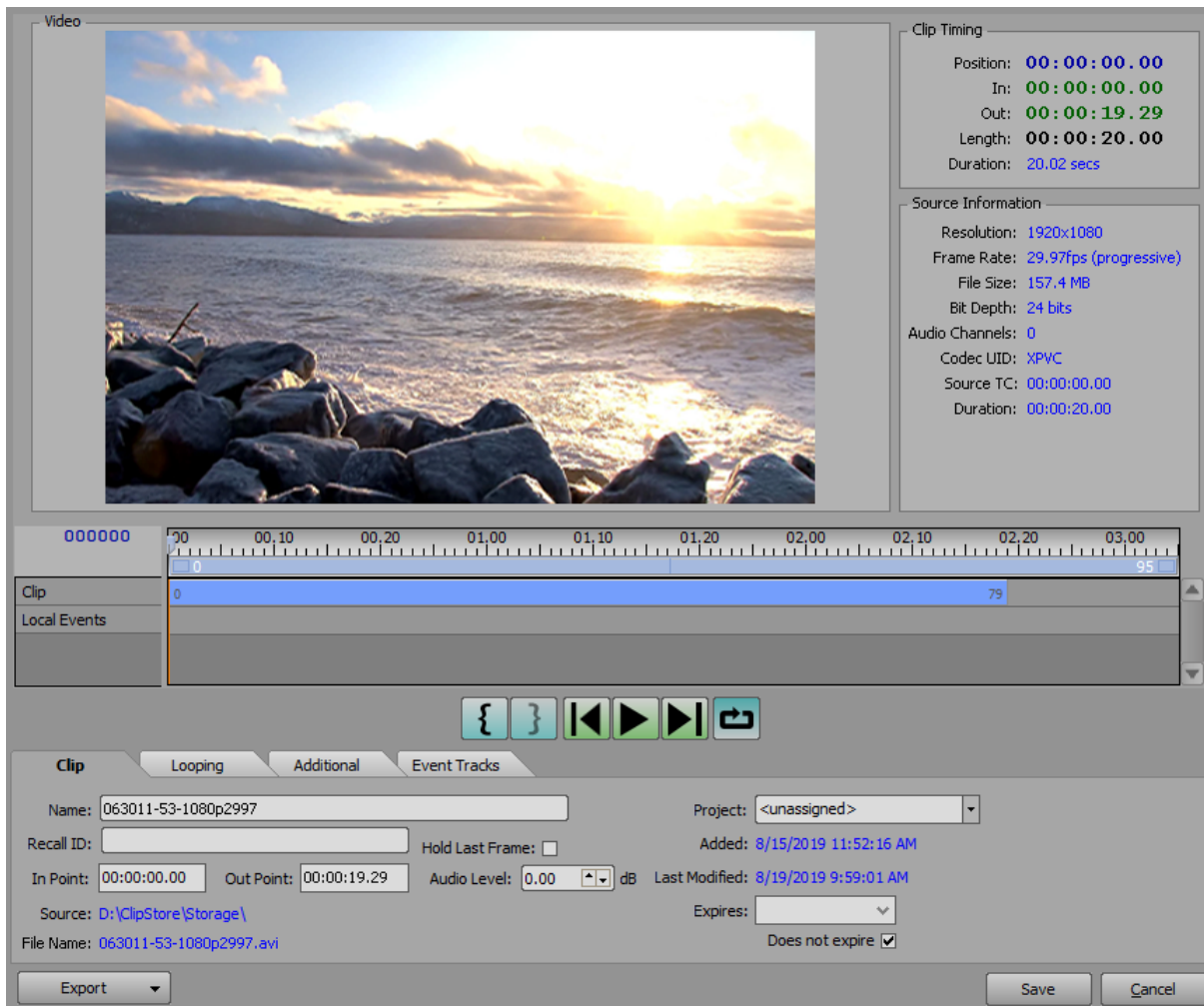

2. In the **In Point** field, enter a frame in point.
3. In the **Out Point** field, enter a frame out point.

4. Select the **Looping** tab.

The **Looping** tab opens.

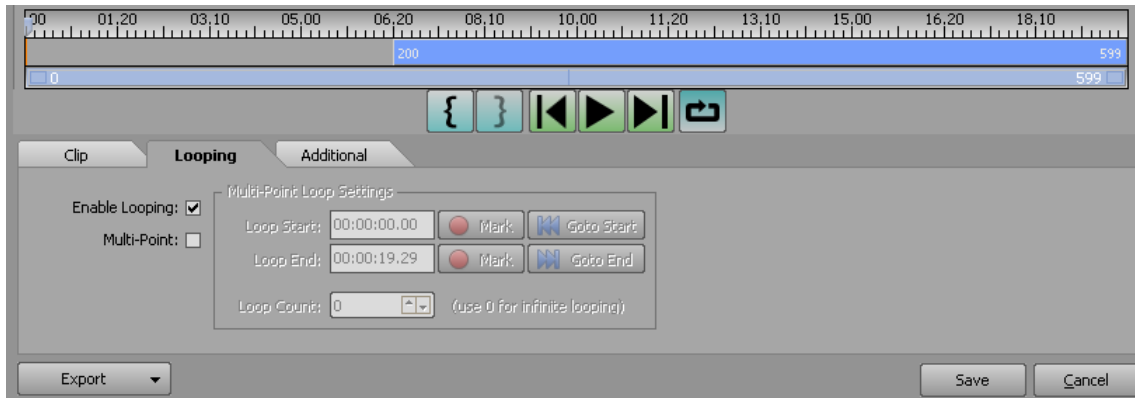

5. In the **Looping** tab, select the **Enable Looping** checkbox.

6. Select the **Multi-Point** checkbox.

7. In the **Multi-Point Loop Settings** section:

- In the **Loop Start** field, enter a frame start for the loop.
- In the **Loop End** field, enter a frame stop for the loop.
- In the **Loop Count** field, enter or select the number of times to play out the loop. Enter **0** for infinite looping.

8. Select **Save**.

The edited clip is updated in the **Clip Browser**.

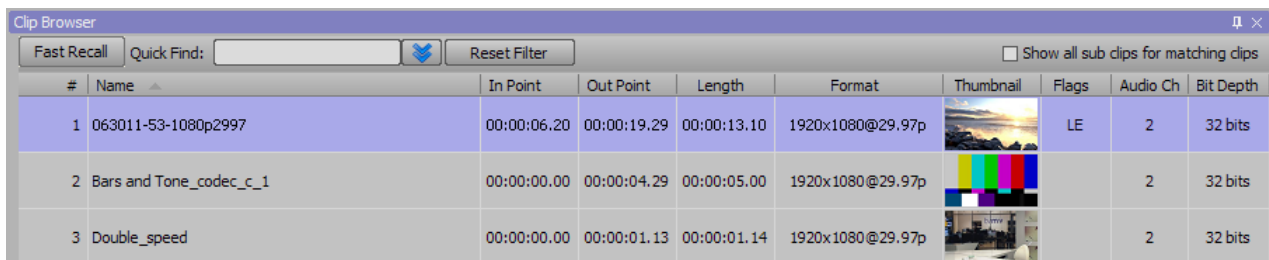

## Send a Video or Image to Clip Store Using the Record Client

Once a recording has been completed it can be sent to the **Clip Store** database to be used within the **Clips** workflow.

1. In XPression, select the **Record Client** (  ) toolbar icon.

The **Record Client** dialog opens.

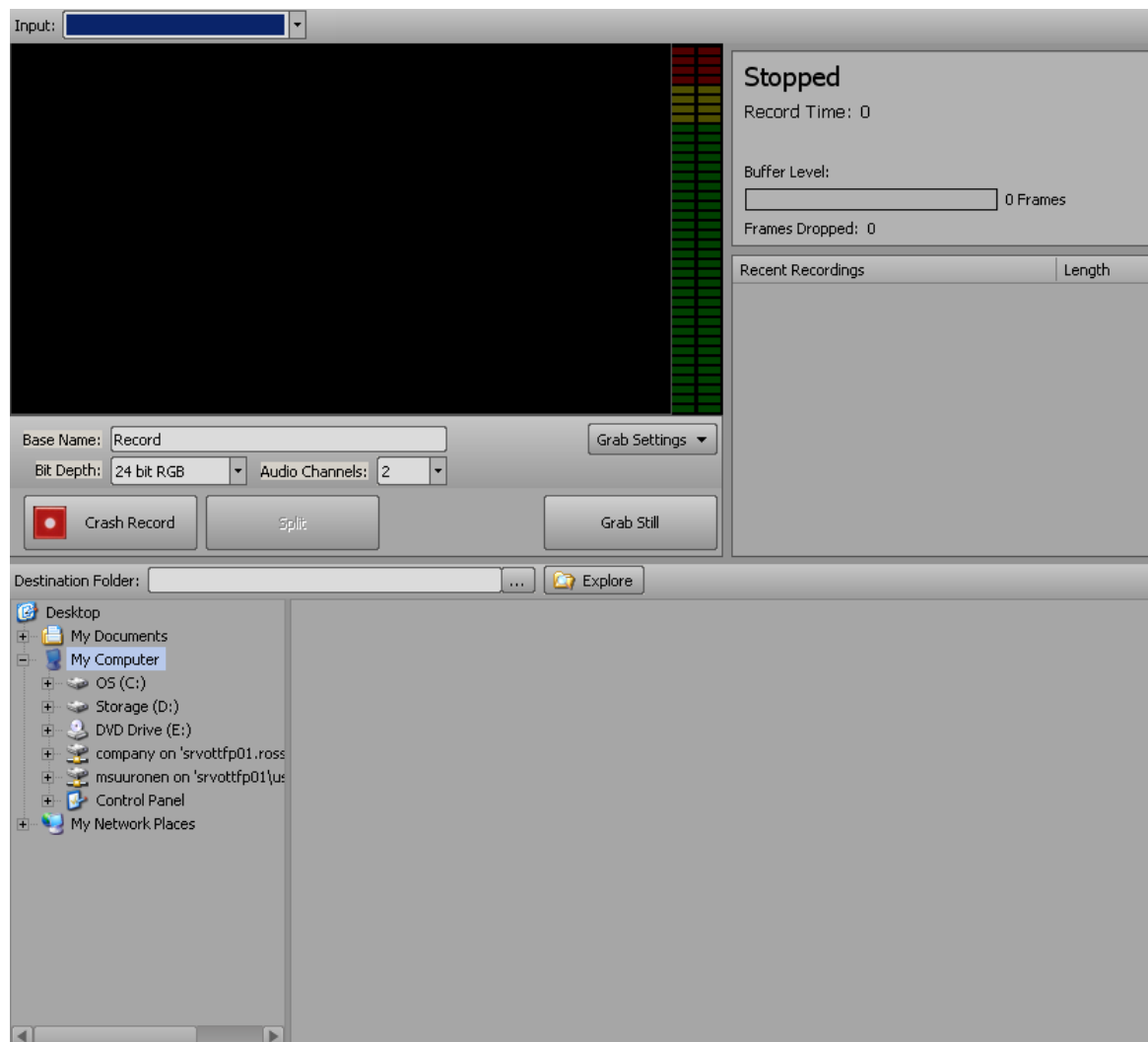

2. Create a video or capture a still image in the **Record Client**.

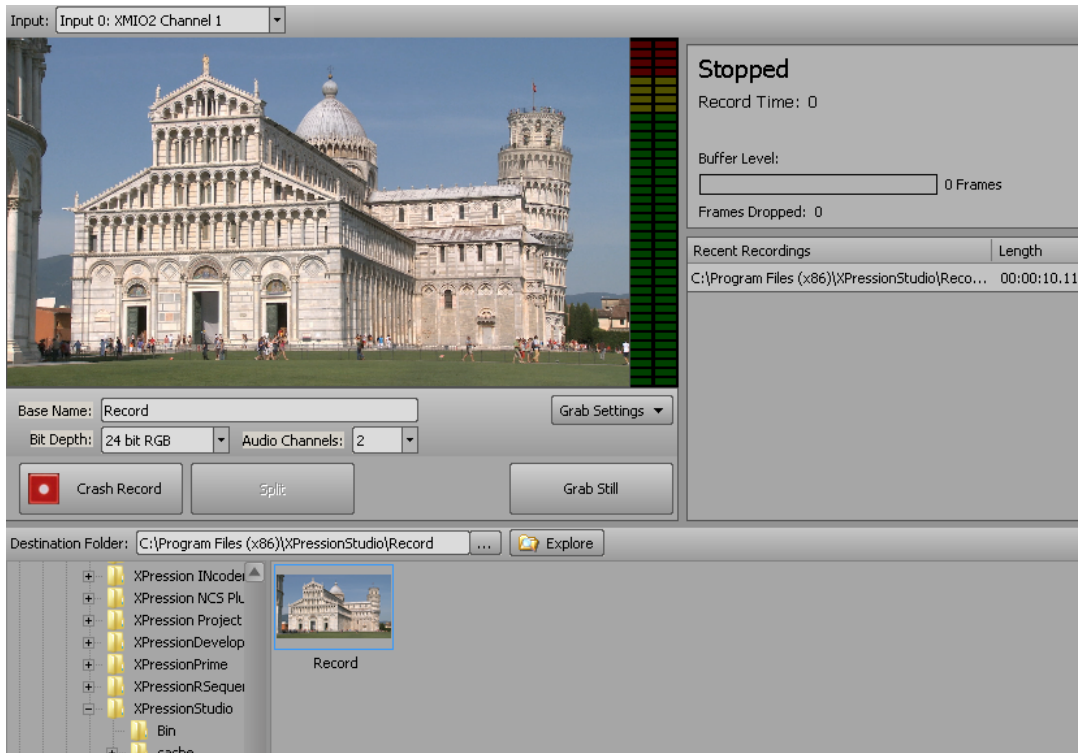

3. Right-click on a video or image thumbnail and select **Send to Clip Store** from the shortcut menu.

Multiple videos and images can be selected by using **Shift + click** or holding **Ctrl** and selecting individual videos and images.

★ Only XPression codec clips should be sent to the Clip Store.

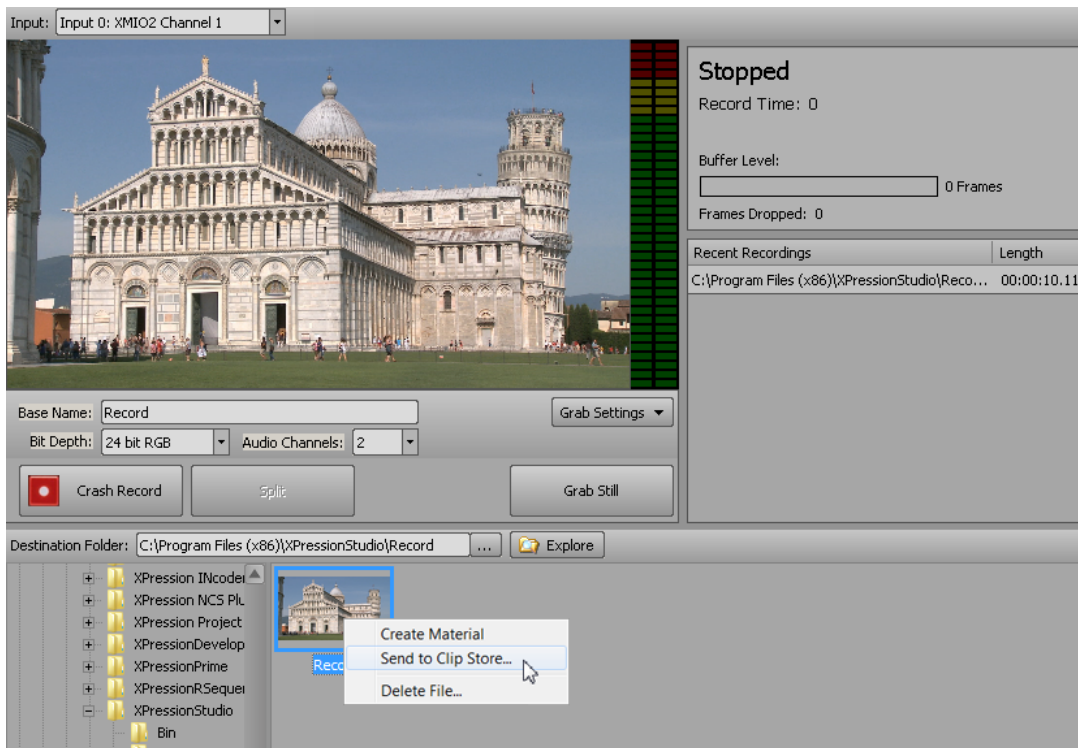

4. The **Send to Clip Store** dialog opens.

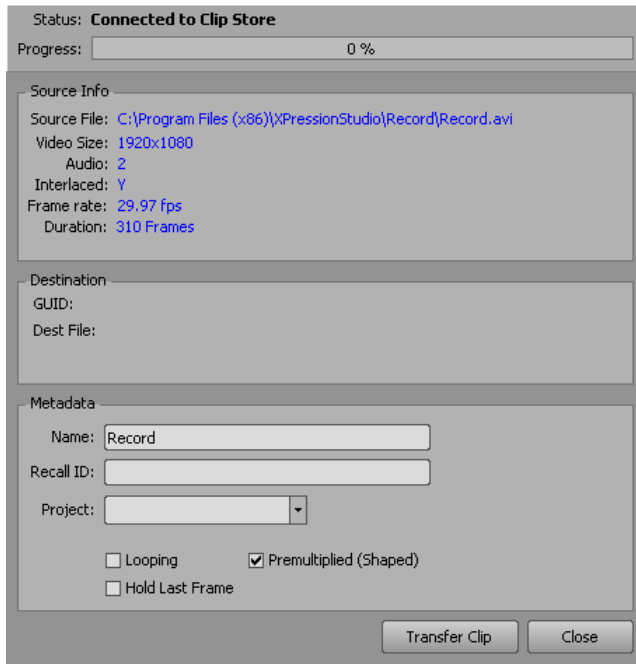

5. In the **Metadata** section, configure the following items:

- **Name** — enter a new name for the video or image in Clip Store, if necessary.
- **Recall ID** — enter an identifier to recall the video or image from an external device.
- **Project** — from the drop-down, select any existing projects from Clip Store or enter a new project name for the video or image. New projects are automatically added to the Clip Store.
- **Looping** — select to infinitely replay the video each time it reaches the end.
- **Hold Last Frame** — select to freeze the video on the last frame after playing.
- **Premultiplied (Shaped)** — select to multiply/shape the fill signal color information by the luminance information in the key signal.

## 6. Select **Transfer Clip**.

The video or image file is transferred to the Clip Store. Once the transfer has successfully completed, the **Status** is listed as **Import Complete**, the **Progress** bar is at 100%, and **Destination** details are listed.

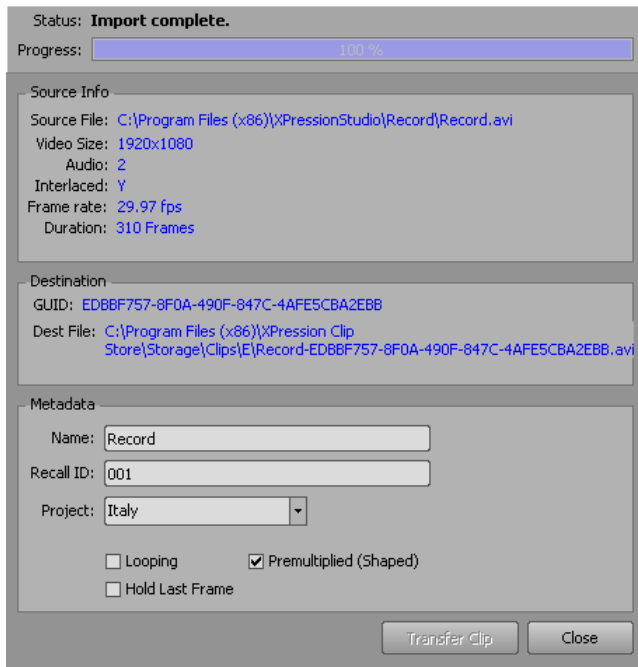

## Preset Event Tracks

In the **Clip Store Manager** you can create preset events tracks with RossTalk and Scene Director trigger events which can be assigned to clips in the clip editor.

XPression INcoder must be configured and connected to the Clip Store in order to assign event tracks to a processor in the INcoder.

For more information on configuring INcoder, refer to the *XPression INcoder User Guide*.

### To configure the events in the Clip Store Manager:

1. Open the XPression Clip Store Manager.
2. In the **Object Browser**, select **Event Tracks** from the Clip Store menu tree.

The **Event Tracks** section opens in the main window.

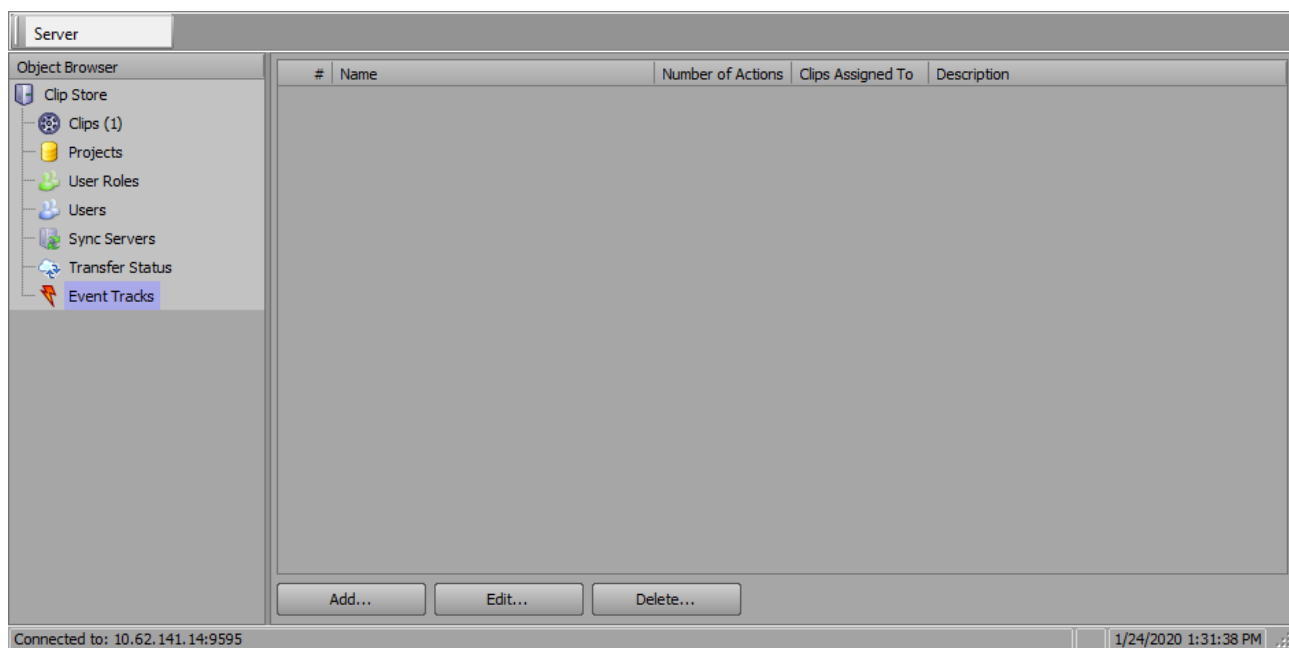

3. Select **Add** to add an event track.

The **New Event Track** dialog opens.

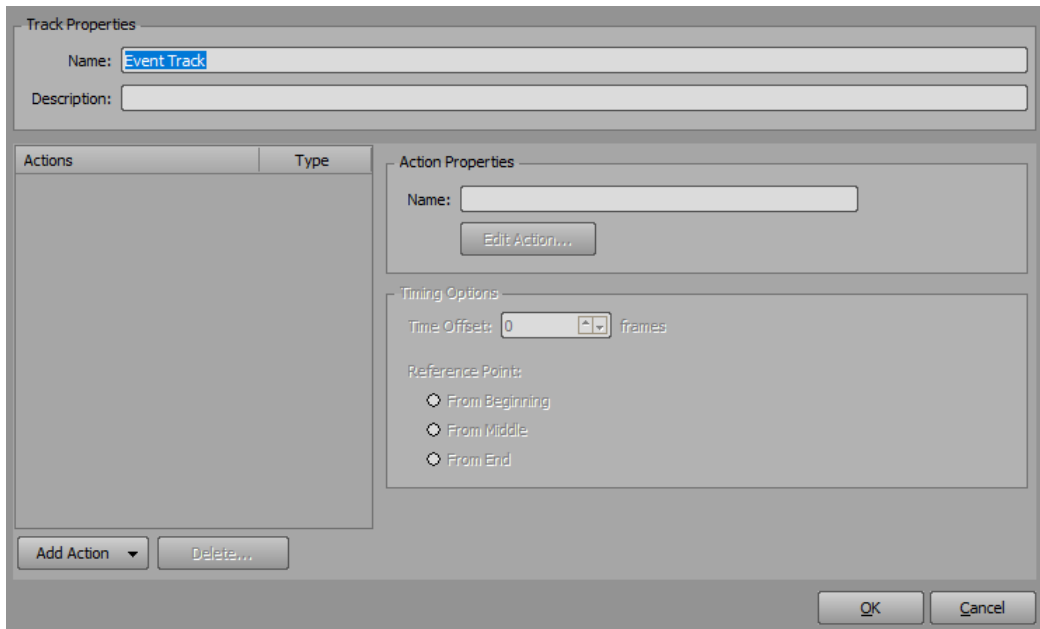

4. In the **Track Properties** section:

- In the **Name** field, enter a name for the event track.
- In the **Description** field, enter a brief description for the event track if necessary.

5. Select **Add Action** and select one of the following as an action for the event:

- **RosTalk Event**
- **SceneDirector Trigger**

The selected action is added to the **Actions** list.

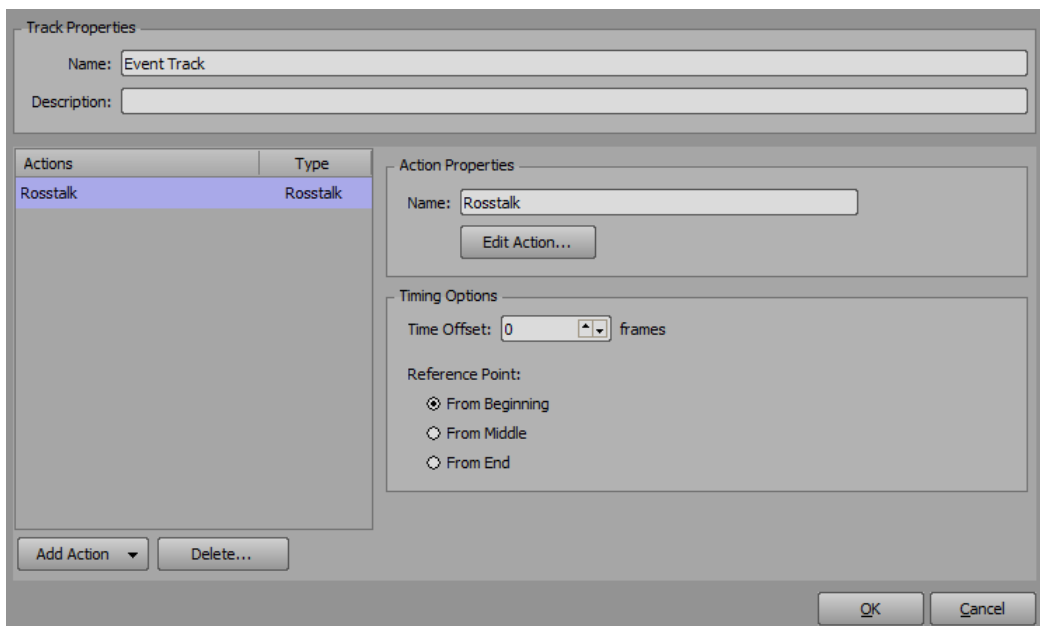

6. In the **Action Properties** section, in the Name field, enter a name for the action.

7. Select **Edit Action** to configure the properties of the action.

If a **RossTalk** action was selected, then the **RossTalk Event Properties** dialog opens.

If a **SceneDirector Trigger** action was selected, then the **Trigger Event Properties** dialog opens.

8. Configure the selected action:

### RossTalk Event

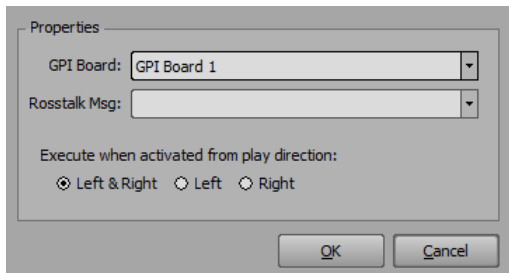

9. In the **Properties** section, from the GPI Board drop-down, select the GPI board to use for the RossTalk message.

a. From the **RossTalk Msg** drop-down, select the RossTalk message to use for the event.

For more information on individual RossTalk commands, refer to the *GPI On XPression* app note.

b. Select one of the **Execute when activated from play direction** options:

- **Left & Right** — execute the event when the play direction of the track is moving left or right.
- **Left** — execute the event when the play direction of the track is moving left only.
- **Right** — execute the event when the play direction of the track is moving right only.

### Trigger Event

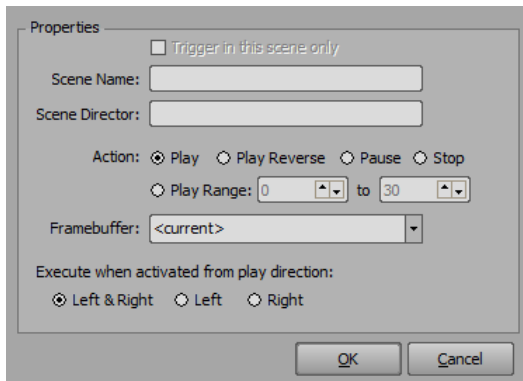

★ The **Trigger in this scene only** option is not supported with event tracks.

10. In the **Properties** section, do the following:

a. In the **Scene Name** field, enter the name of the scene with the **Scene Director** to trigger in other on-air scenes.

The wildcard character (\*) is supported.

b. In the **Scene Director** field, enter the name of the **Scene Director** to trigger from the selected scene(s).

- c. Select an **Action** for the Scene Director when triggered:
  - **Play** — play out the tracks in the Scene Director.
  - **Play Reverse** — play out the tracks in the Scene Director in reverse.
  - **Pause** — pause the tracks in the Scene Director.
  - **Stop** — stop the tracks in the Scene Director.
  - **Play Range** — select this to set a play range in frames for the payout. Use the adjacent fields to enter or select the play range in frames.
- d. From the Framebuffer drop-down, select the framebuffer on which the scene will be triggered.
- e. Select one of the **Execute when activated from play direction** options:
  - **Left & Right** — trigger the **Scene Director** when the play direction of the track is moving forward or in reverse.
  - **Left** — trigger the **Scene Director** when the play direction of the track is moving forward only.
  - **Right** — trigger the **Scene Director** when the play direction of the track is moving in reverse only.

11. Select **OK**.

The **RossTalk Event Properties** or **Trigger Event Properties** dialog closes.

12. In the **Timing Options** section, in the **Time Offset** field, enter or select a number of frames to offset the event and select a **Reference Point** for the offset:

- **From Beginning** — apply the time offset from the beginning of a clip.
- **From Middle** — apply the time offset from the middle of a clip.
- **From End** — apply the time offset from the end of a clip.

13. Select **OK**.

The **New Event Track** dialog closes and the event is added to the **Event Track** list.

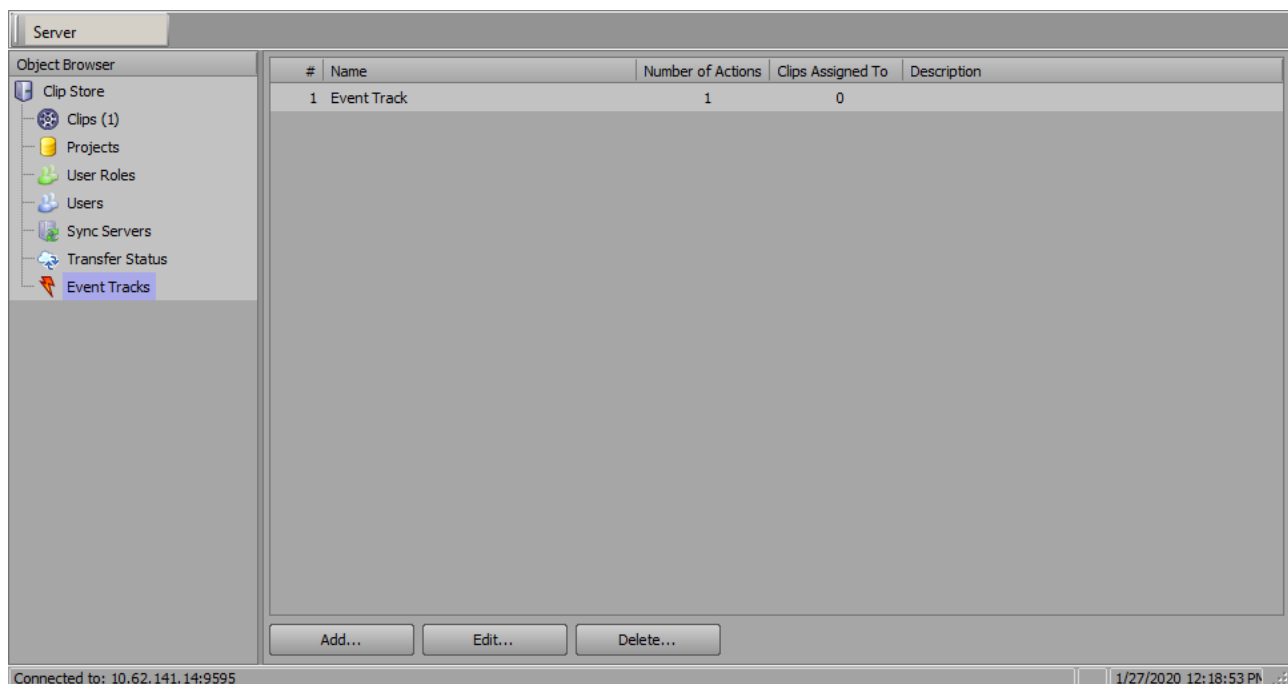

**To assign the event track to a processor in the INcoder:**

1. In XPression INcoder, select the **Configuration** tab.  
The **Configuration** section opens.
2. In the **Configuration** section, select the **Processors** tab.  
The **Processors** tab opens.

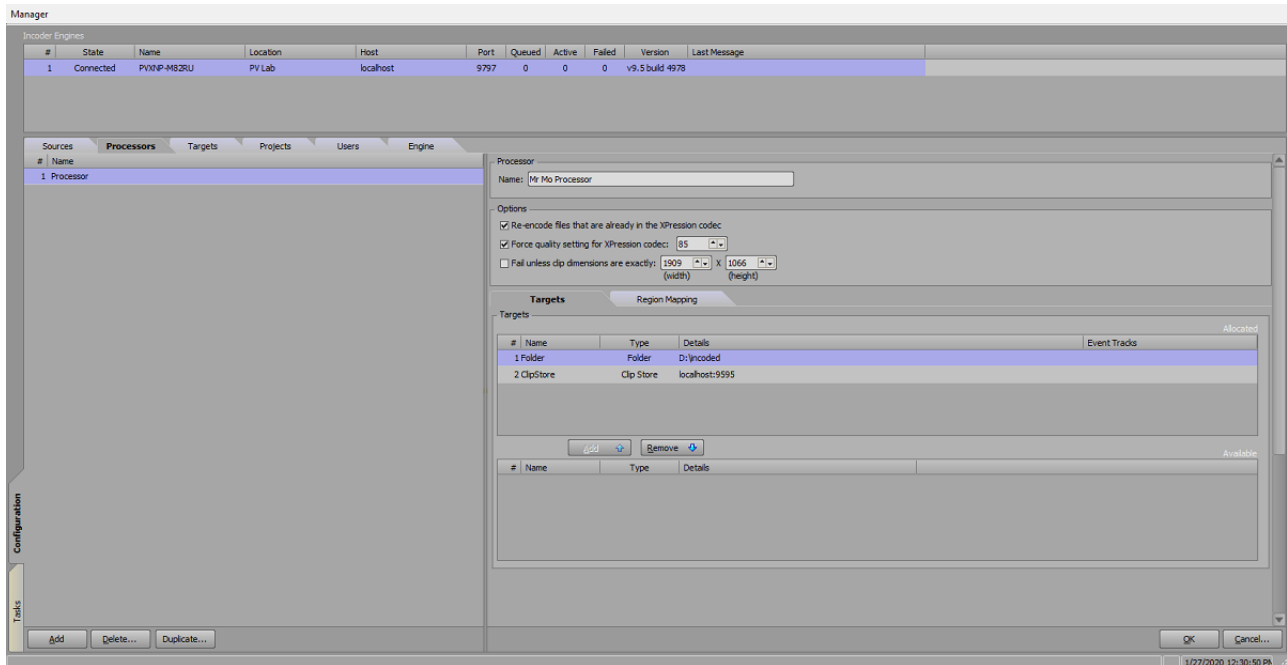

3. From the **Processors** list, select a processor.
4. In the **Targets** section of the selected processor, select the Clip Store that includes the configured event track(s).  
The **Clipstore Options (ClipStore)** section is displayed.

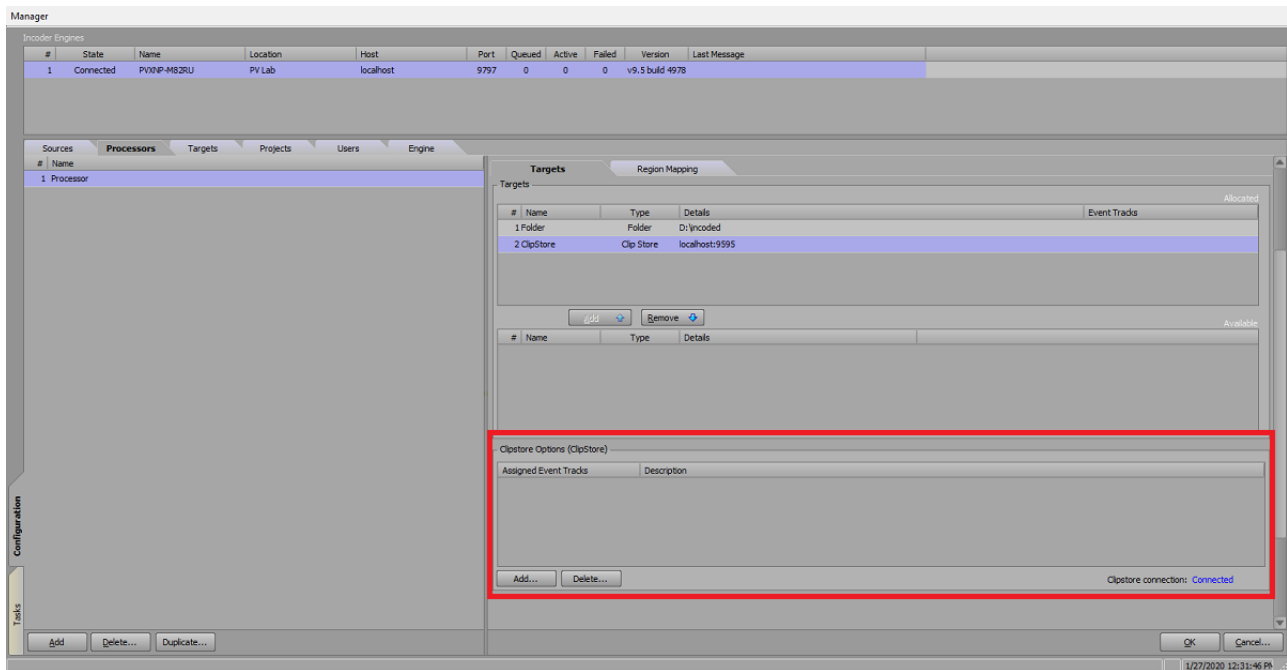

5. In the **Clipstore Options (ClipStore)** section, select **Add**.

The **Add Event Tracks** dialog opens.

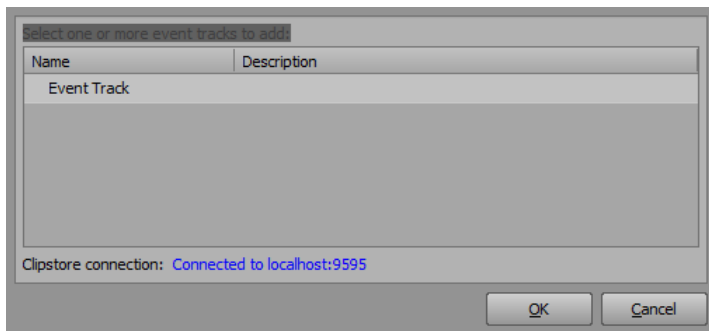

6. Select an event track from the list and select **OK**.

The selected event track is added to the **Assigned Event Tracks** list in the **Clipstore Options (ClipStore)** section.

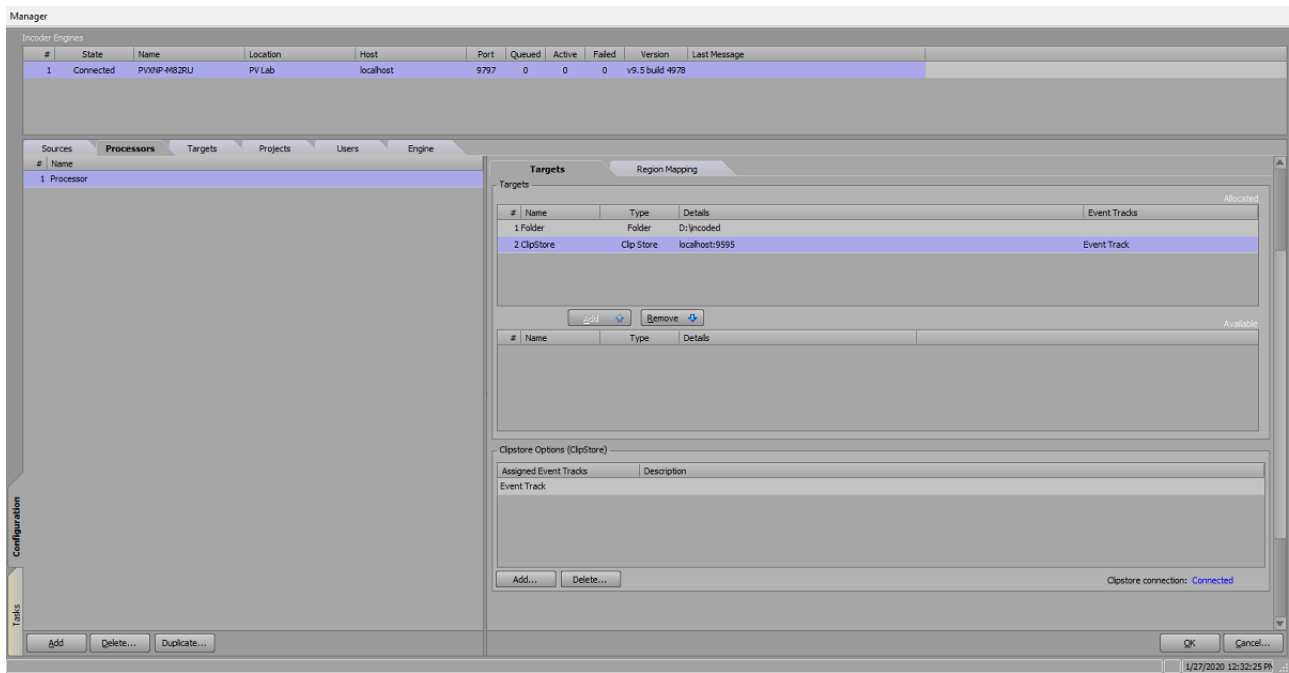

7. Select the **Sources** tab.

The **Sources** tab opens.

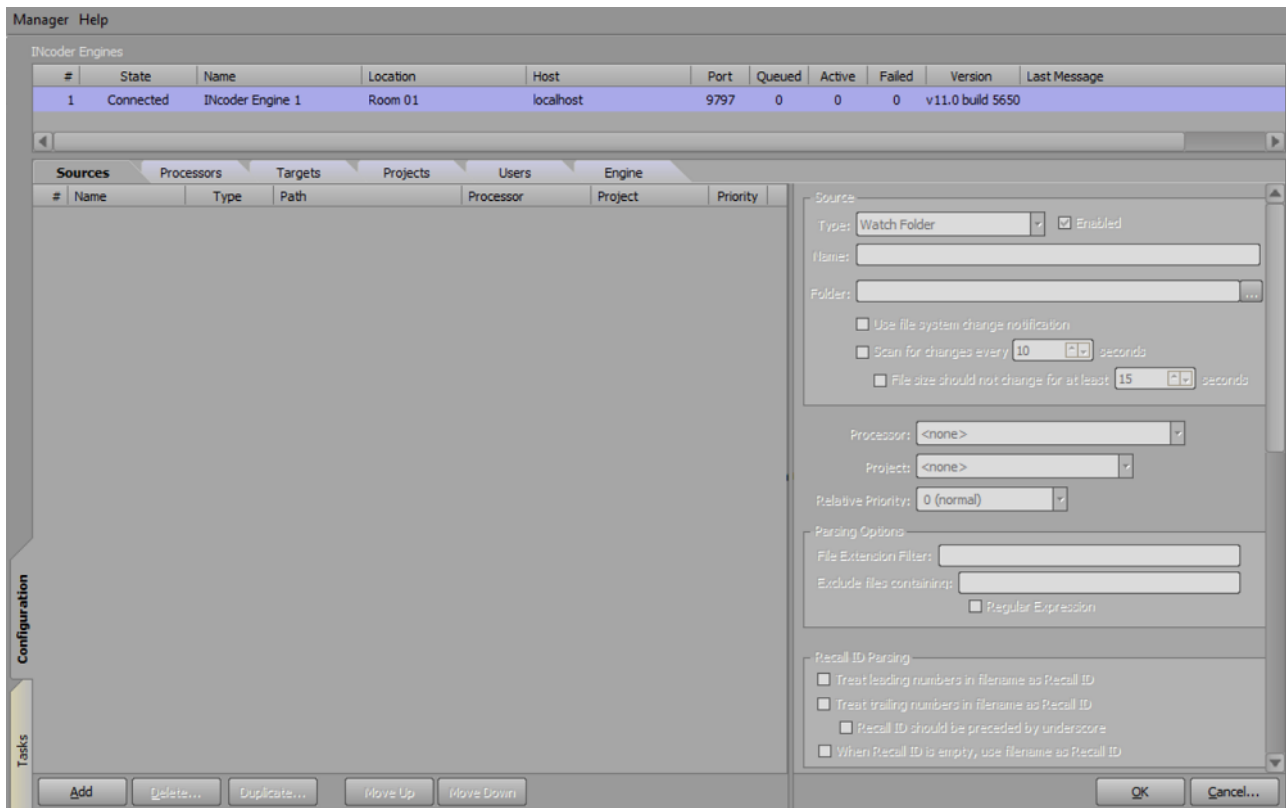

8. From the **Sources** list, select a source.

9. From the **Processors** list, select the processor that contains the assigned event track(s) and select **OK**.

## To add an event track to a clip:

1. In the **Clip Browser** (or a Server Channel) in XPression, right-click on a clip and select **Edit** from the shortcut menu (or press F8).

The **Edit Clip** dialog opens.

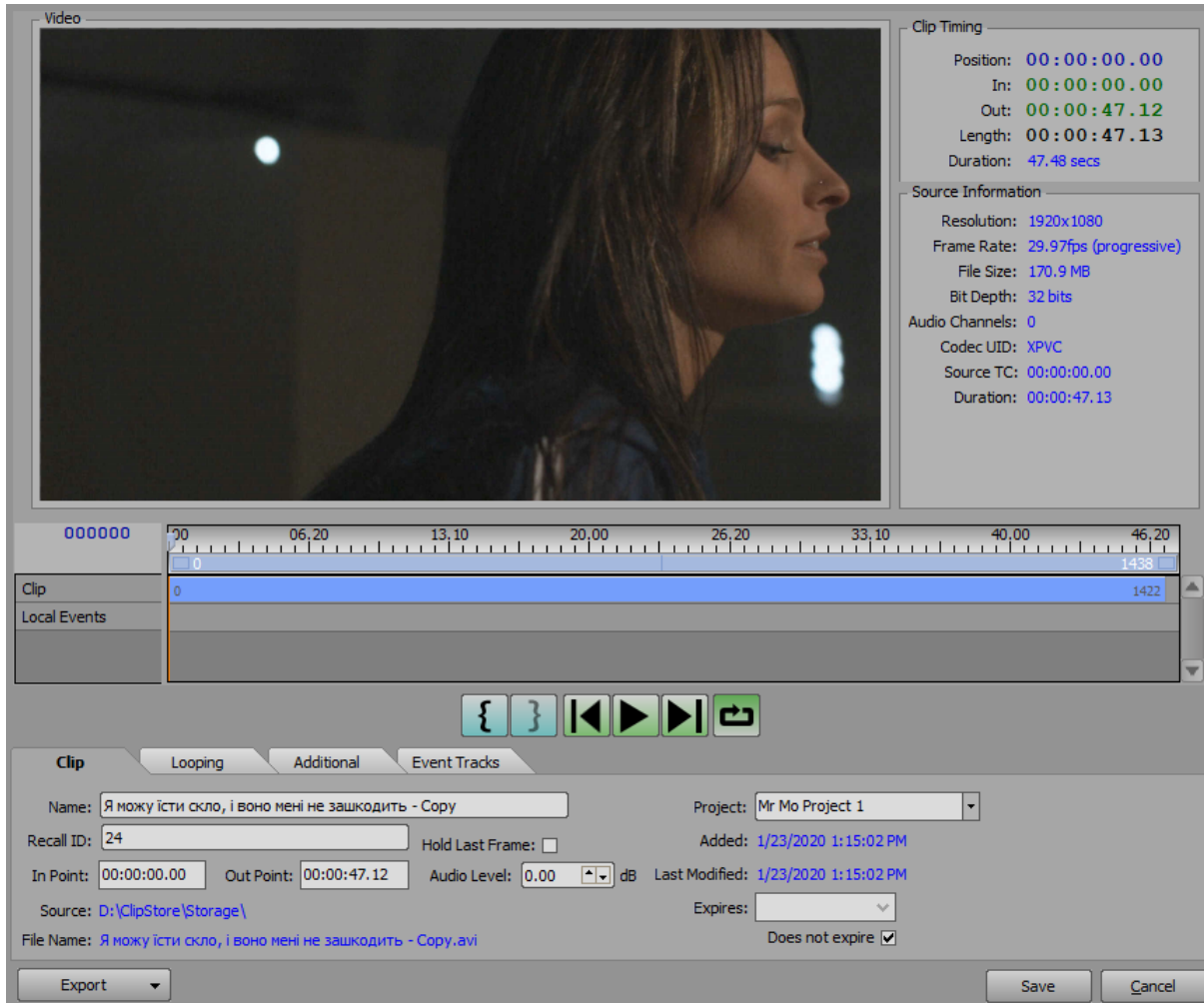

2. Select the **Event Tracks** tab.

The **Event Tracks** tab opens.

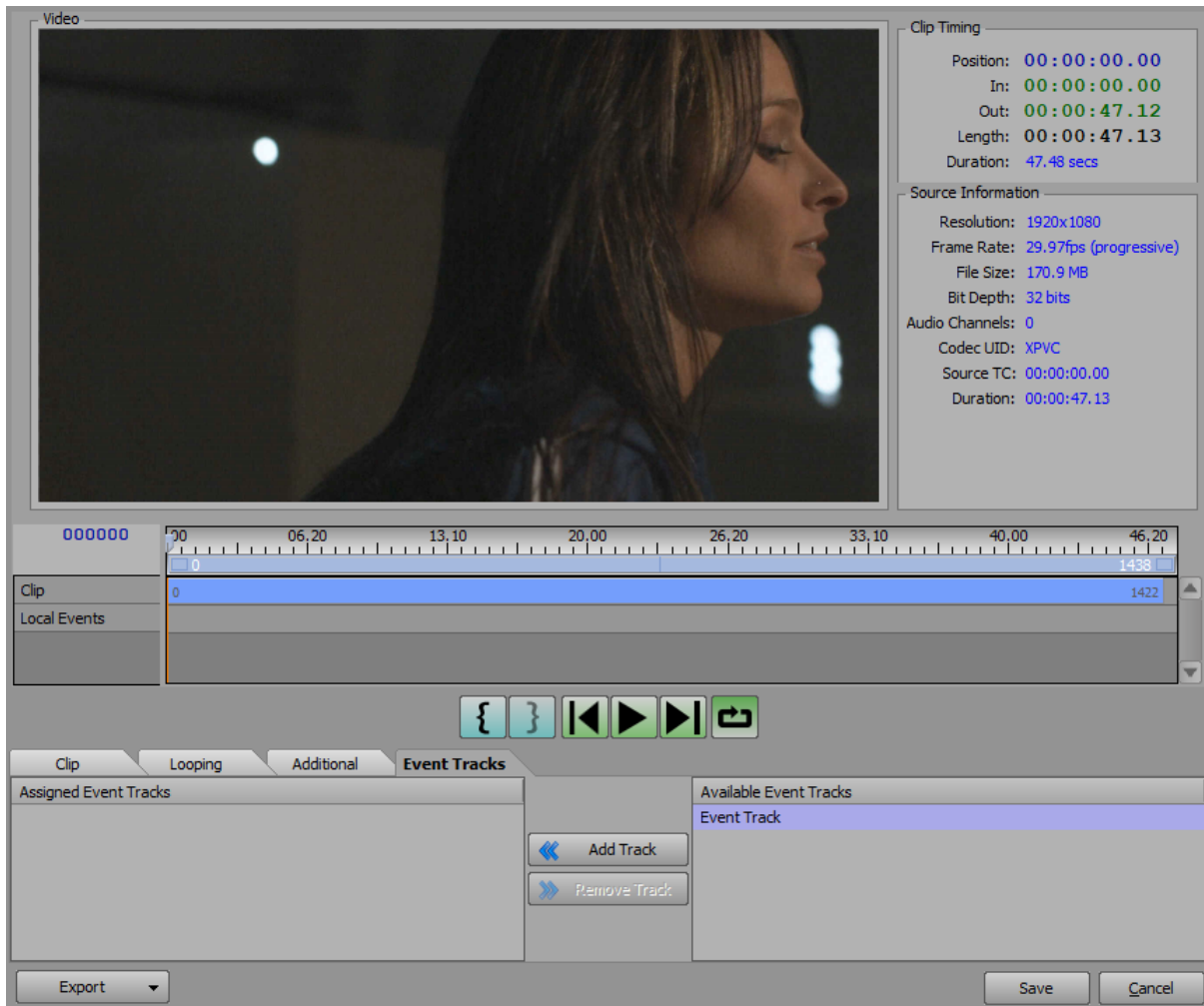

3. In the **Event Tracks** tab, select an event track from the **Available Event Tracks** list and select **Add Track**.

The event track is added to the **Assigned Event Tracks** list and appears as an event track in the clip timeline.

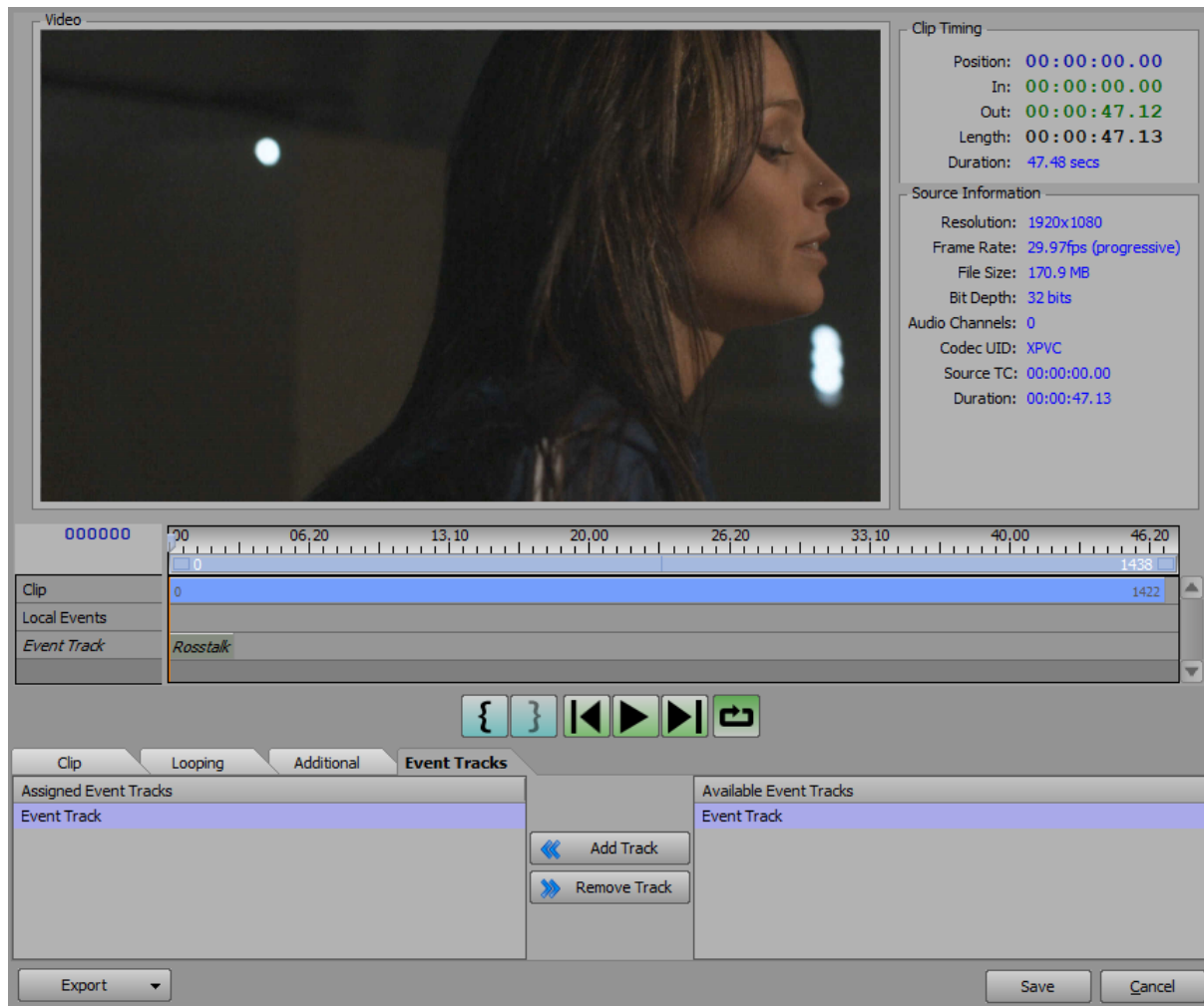

#### To unassign an event track:

- Select the event track in the **Assigned Event Tracks** list and select **Remove Track**.

#### To assign an event track as a local, editable event:

- Right-click on the event in the Event Track timeline and select **Preset Event Track > Copy Events to Local Event Track**.

A prompt will give the option to keep the original event track or delete it from the timeline. The event will appear in the Local Events timeline once added.

The original event track can be added back to the clip anytime by reassigning it through the **Event Tracks** tab.

# PBus

The following topics are discussed in this section:

[PBus Overview](#)

[Configuring PBus and PBus Recalls](#)

[PBus Triggers](#)

[PBus LEARN Commands](#)

[PBus Mapping](#)

[Using PBus from a Switcher to Recall Items](#)

[Using PBus for XPression Clips](#)

## PBus Overview

PBus (Peripheral Bus) is an industry standard protocol designed to allow production switchers to communicate with external devices. Most large production switchers have some capability of sending PBus commands to a device.

XPression supports PBus over standard RS232 or TCP/UDP sockets.

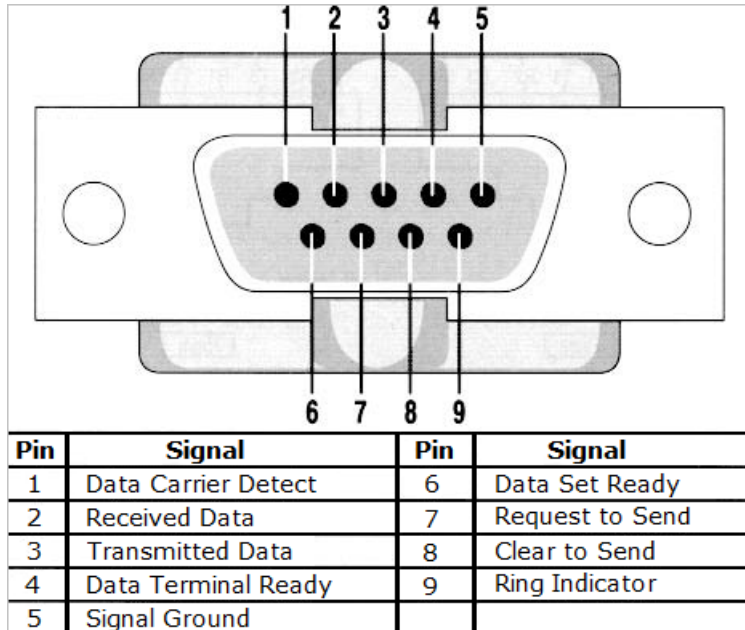

The chassis of some turnkey XPression systems might not include a standard RS232 port. However, it is possible to use an RS232-USB adaptor.

If the production switcher has an RS422 serial port, then you will require an RS232-RS422 adaptor. This adaptor will require its own power supply. Generally, the adaptors that are port-powered will not function for these purposes.

★ On an XPression Bluebox system, a limited subset of PBus functionality is available. PBus commands can be used to trigger take items that have been pre-built in an XPression sequence using either XPression Designer or Studio. It is not possible to customize the PBus registers actions using Bluebox. Each register number corresponds to a specific take item number and can not be changed. It is not possible to load the PBM or PBMS PBus mapping files on Bluebox.

## Configuring PBus and PBus Recalls

Use the Hardware Setup to configure XPression to accept PBus commands. PBus is an industry standard protocol designed to allow production switchers to communicate with external devices.

### To enable XPression to accept PBus commands:

1. In XPression, select **Edit > Hardware Setup**.

The **Hardware Setup** dialog opens.

2. Select the **GPI / Tally Boards** tab.

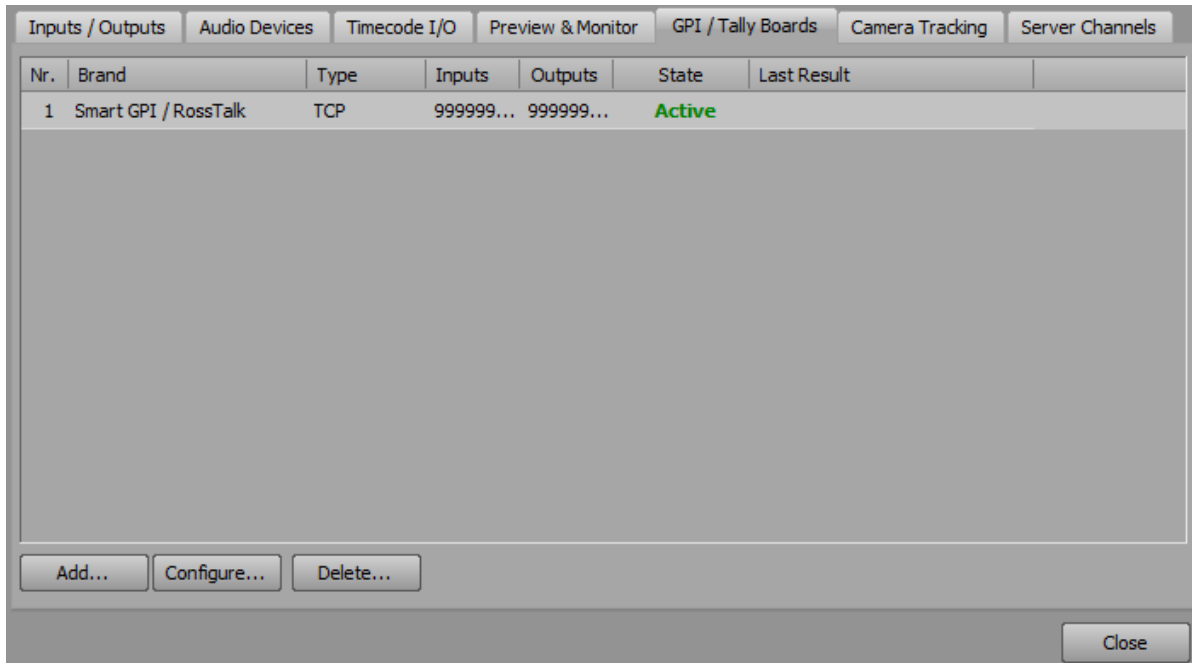

3. Select **Add**.

The **Add New GPI Board** dialog opens.

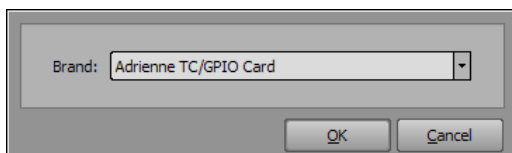

- From the **Brand** drop-down, select **PBus** and then select **OK**.

The **PBus Setup** dialog opens.

The screenshot shows the PBus Setup dialog box. It is divided into several sections:   
- **Settings:** A dropdown menu for 'State' is set to 'Enabled'. Below it, the 'Mode' section has three radio buttons: 'Serial RS232' (selected), 'TCP', and 'UDP'.   
- **RS232 GPI Settings:** A group of dropdown menus for 'Port' (Comport 1), 'Baudrate' (9600), 'Data Bits' (8), 'Parity' (None), 'Stop Bits' (1), and 'Flow Control' (None).   
- **Network Settings:** A dropdown menu for 'TCP Port' is set to 7790.   
- **PBus Options:** A group of checkboxes: 'Clear layer on recall' (checked), 'Move sequencer focus on recall' (unchecked), 'Cue item on recall' (checked), 'Video Clips cue directly to framebuffer' (checked), and 'Ignore LEARN command' (unchecked). Below this is a 'Data Logger' dropdown menu set to 'None'.   
- At the bottom right, there are 'OK' and 'Cancel' buttons.

- In the **Settings** section, from the **State** drop-down, select **Enabled**.

Select **Disabled** to turn off PBus.

- Select a communication **Mode** for PBus:

- **Serial RS232** — select to use RS232 to send PBus signals to XPression.
- **TCP** — select to use TCP/IP to send PBus signals to XPression.
- **UDP** — select to use UDP sockets to send PBus signals to XPression.

- Configure the selected mode:

#### RS232 GPI Settings

- From the **Port** drop-down, select the Communication port that receives the signals.
- From the **Baudrate** drop-down, select the communication speed for the signals.
- From the **Data Bits** drop-down, select the number of bits used to represent one character of data for the signals.
- From the **Parity** drop-down, select the method used to check for lost data in a signal.
- From the **Stop Bits** drop-down, select the number of bits used to indicate the end of a byte in a signal.
- From the **Flow Control** drop-down, select the data transmission rate controller for a signal.

The flow control can be set to **Hardware** or **None**, but it must be set the same in both XPression and the transmitting device.

#### TCP & UDP

- In the **Network Settings** section, in the **TCP Port/UDP Port** field, enter or select the communication port that receives the signals.

- In the **PBus Options** section, configure the PBus recall options.

XPression normally does not perform any action when a PBus recall command is issued. Instead, it stores the recall ID to be used later when a PBus trigger command is issued.

**Clear layer on recall** — when this option is selected and a PBus recall command is received, XPression will look to see which channel and layer that the take item being recalled has been assigned. It will then immediately clear that layer and channel. However, the take item will not be read to air until such time as a PBus Trigger command is received to put the item on air. This configuration option is recommended to be enabled in situations where XPression might be used to play back clips/graphics and to ensure that as soon the recall command is issued, any previous graphic that might have been left over on the layer will be removed.

**Move sequencer focus on recall** — this configuration option can be selected to move the sequencer focus to the item that is being recalled. This can be useful as a means of generating a preview output that will show a rendered frame from the item that will be put on air when the PBus trigger command is received.

**Cue item on recall** — selecting this option will place the take item into a cued state when the recall command is received. This is useful when using video clips which might take a few frames to cue.

**Video Clips cue directly to framebuffer** — selecting this option will cause the video clips from the Clip Store that are assigned to a PBus register to cue directly onto the hardware output of XPression in a paused state. When the play command is received, they will begin playing.

**Ignore LEARN command** — selecting this option will ignore the LEARN command. LEARN stores the clip currently loaded into a server channel into the PBus register list when the LEARN command is received.

9. From the **Data Logger** drop-down, select an encoding scheme for the data log.

The options are:

- **None** — select this option to use no data logging.
- **ASCII** — select this option to use ASCII encoding for the data log.
- **HEX** — select this option to use HEX file formatting for the data log.
- **Both** — select this option to use both ASCII encoding and HEX file formatting for the data log.

10. Select **OK**.

The PBus interface is displayed in the GPI Board list.

11. Select **Close**.

The **Hardware Setup** dialog closes.

12. Select **OK**.

The **PBus Setup** dialog closes and the new PBus interface is added to the GPI Boards table.

#### **For More Information on...**

- configuring and working with GPIs, refer to the *GPI White Paper* available from Ross Video.

## PBus Triggers

XPression supports many PBus Trigger commands.

PBus Trigger Command	Description
Trigger 0 – Play Item	This trigger can be overridden in the PBus mapping. Trigger 0 is normally used to play a take item to air. However, this can be overridden to perform other actions on a per-register basis. These actions can be configured in the PBus mapping menu.
Trigger 1 – Take Sequence Item Off-Air	Trigger 1 is used to take an item off air (assuming it was already on air). The item taken off air will be the take item that was previously recalled using a PBus recall command.
Trigger 2 – Execute GPI	Trigger 2 is used to emulate a standard GPI input. In the XPression Keyboard/GPI Mapping, various actions can be configured to be executed on a GPI input being triggered. It is possible to trigger up to 99 different GPIs through PBus. The GPI number that will be triggered is the number that was previously recalled using a PBus recall command.
Trigger 3 – Clear Framebuffer	Trigger 3 will clear the framebuffer assigned to the device in the PBus channel configuration. If the channel is set to <default>, this trigger will clear Channel 1.
Trigger 4 – Clear Framebuffer Channel 2	Trigger 4 will clear the framebuffer assigned to the device in the PBus channel configuration. If the channel is set to <default>, this trigger will clear Channel 2.
Trigger 5 – Read Current Sequence Item to Air	Trigger 5 will take the currently selected sequence item from the sequencer to air. It ignores the PBus recall command and uses whichever item currently has focus in the XPression sequencer.
Trigger 6 – Resume Channel	Trigger 6 will resume all paused graphics currently on the framebuffer assigned to the device in the PBus Channel Configuration. If the framebuffer is set to <default>, this will resume Channel 1.
Trigger 7 – Resume Channel	Trigger 7 will resume all paused graphics currently on the framebuffer assigned to the device in the PBus Channel Configuration. If the framebuffer is set to <default>, this will resume Channel 2.
Trigger 8 – Resume Take Item	Trigger 8 will resume a single paused take item. The take item will be the item previously recalled by a PBus recall command.
Trigger 10 – Bank 0	Trigger 10 will change the last recall command into an ID in the 0-99 range (refer to the Bank 1 command below for more details).

PBus Trigger Command	Description
Trigger 11 – Bank 1	<p>Trigger 11 is used to allow switchers that can only send PBus recall commands up to 99 to be able to recall take items with values of between 100 and 199.</p> <p>This “bank 1” command will add 100 to the last recalled item using a PBus recall command. For example; to recall take ID 135 and put it on air, a switcher could send:</p> <ul style="list-style-type: none"> <li>• Recall 035</li> <li>• Trigger 11 (changes the 035 into 135)</li> <li>• Trigger 0</li> </ul> <p>It is not necessary to switch back to bank 0 after sending a bank 1 command. XPression will automatically revert to bank 0 for the next PBus recall command.</p>
Trigger 12 – Bank 2	Changes the last PBus recall command into an ID in the 200-299 range.
Trigger 13 – Bank 3	Changes the last PBus recall command into an ID in the 300-399 range.
Trigger 14 – Bank 4	Changes the last PBus recall command into an ID in the 400-499 range.
Trigger 15 – Bank 5	Changes the last PBus recall command into an ID in the 500-599 range.

## PBus LEARN Commands

When a PBus LEARN command is received from a remote device, XPression will look to the configured server channel for the PBus device, and if there is a clip currently cued on that server channel it will assign that clip into the PBus register.

There is an option **Ignore LEARN command** in the **PBus Setup** dialog in the **Hardware Setup**. This option is useful if you are manually assigning clips to PBus registers and you do not want to change/overwrite them when storing memories on the production switcher. Most production switchers automatically send the PBus LEARN command when storing the memory.

### **For More Information on...**

- the PBus LEARN command, refer to the appropriate switcher documentation.

# PBus Mapping

Use PBus mapping to assign clips, functions, scenes, scripts, and other actions and functions to device registers, and then save and load the maps.

The following procedures are covered in this section:

[Configuring PBus Mapping](#)

[Assigning an Action to a PBus Register](#)

[Remapping a PBus Register](#)

[Loading and Saving Maps](#)

## Configuring PBus Mapping

Use the **PBus Device Configuration** dialog to configure the **Device IDs** and server channels.

### To configure PBus Mapping:

1. In XPression, select the **Sequence** editor.
2. Select **Display > PBus Mapping**.

The **PBus Mapping** window opens.

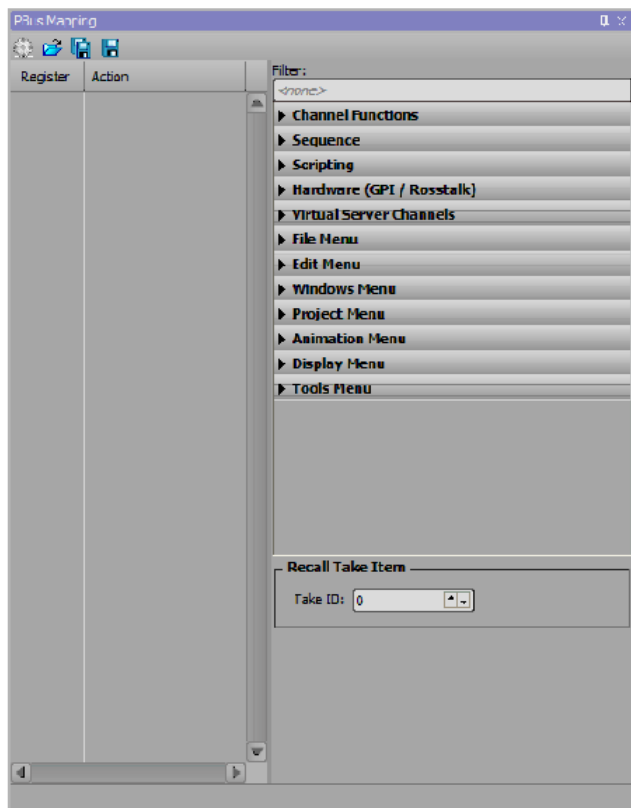

3. Select the **Setup Device Configuration** (  ) icon.

The **PBus Device Configuration** dialog box opens.

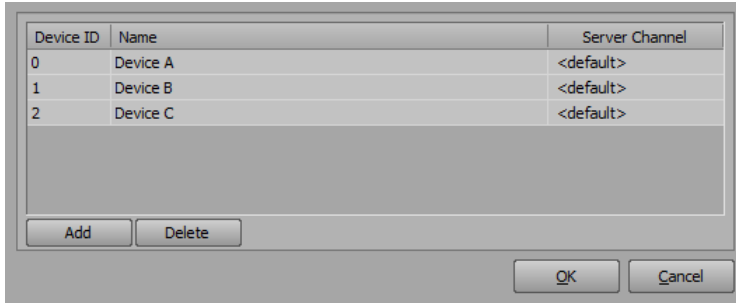

4. Select **Add** to add a **Device ID**.

A device ID is added to the **PBus Device Configuration** list. At least one **Device ID** must be added. The **Device ID** is the ID number that will be sent in PBus messages transmitted from the production switcher.

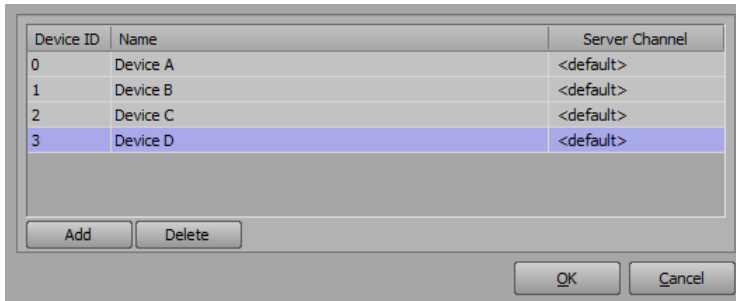

5. Select inside the **Device ID** column of the ID and enter or select a different ID number from the default number, if necessary.

PBus **Device IDs** must be between 0 and 23.

6. Select inside the **Name** column of the ID and enter a name to refer to the **Device ID**. For example, **Device D**.
7. Select inside the **Server Channel** column of the ID and from the drop-down, select a specific output framebuffer or use the **<default>** framebuffer.

If the framebuffer is set to anything other than **<default>** when a PBus recall command is received for a specific **Device ID**, the item will be played on the selected framebuffer. If **<default>** is selected, the item will be played on the framebuffer for which the original take item was configured. When a clip from the Clip Store is assigned to a register and **<default>** was selected for the **Server Channel**, the first device configured will use **Server Channel 1**, the next will use **Server Channel 2**, etc.

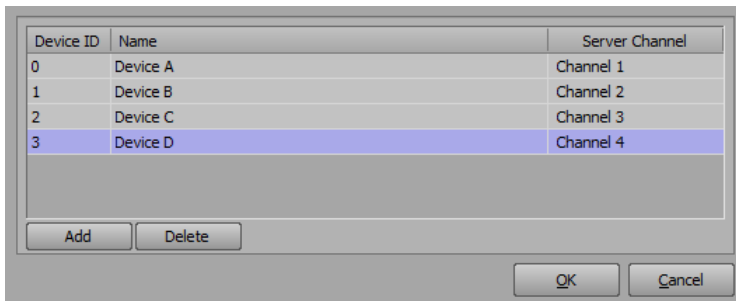

If XPression does not have the **Clips** option, then the **Server Channel** configuration column will be missing and all take items will be cued to the channel assigned to them through the **Sequencer**.

8. Select **OK**.

The **Device IDs** are added as tabs at the bottom of the **PBus Mapping** window under the assigned device names. If there are no tabs added, then a **Device ID** was not added to the **PBus Device Configuration** list.

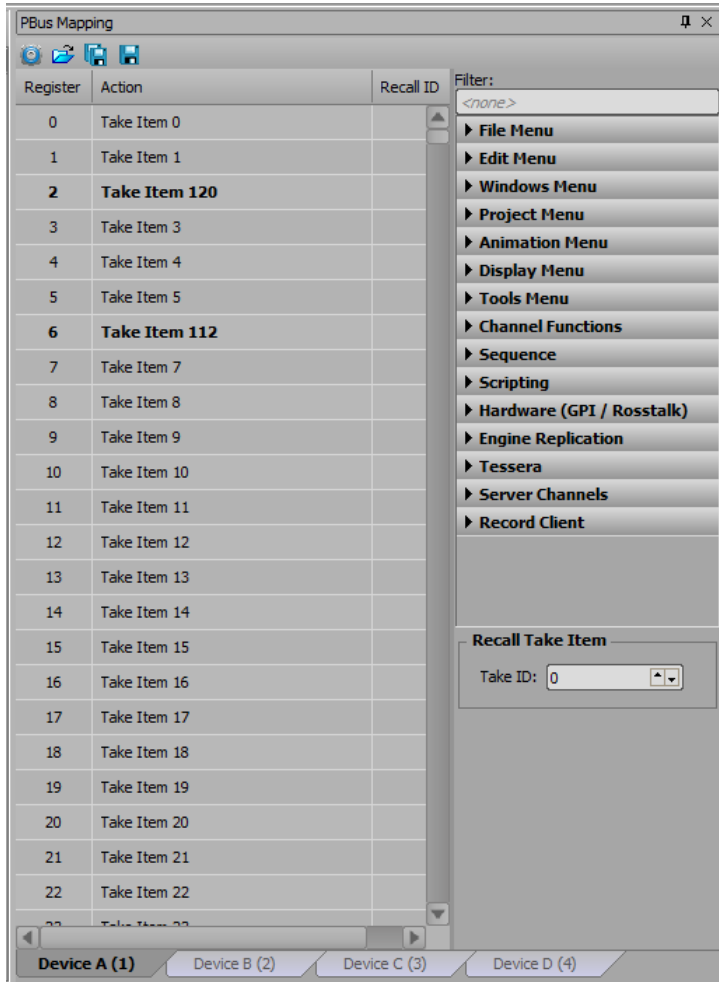

## Assigning an Action to a PBus Register

Each device has a list of 4095 registers which can be recalled through PBus.

★ Some switchers can only support the first 99 registers.

Each PBus register can be assigned an action that will be executed after the register is recalled and **Trigger 0** is received. The default action for each register is to play the corresponding **Take Item** with the same number as the PBus register.

### To assign an action to a PBus register:

1. In the **PBus Mapping** window, select an action from the actions list to the right of the devices.

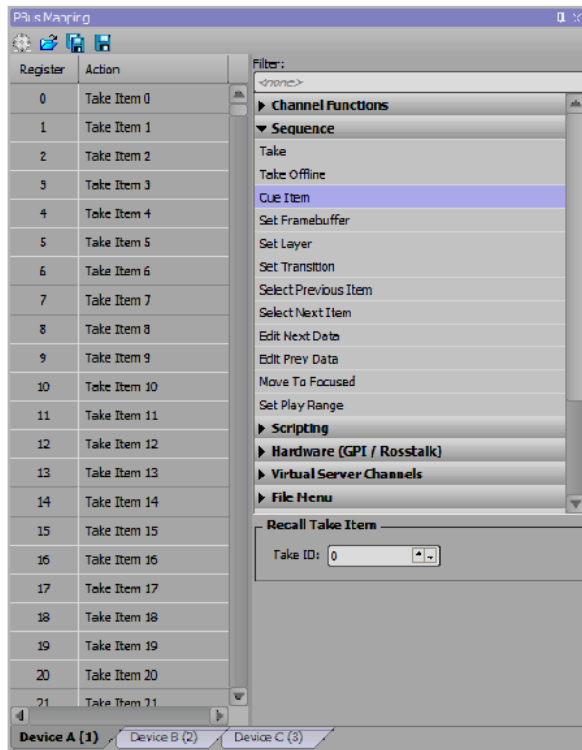

2. Drag and drop the action onto a register.

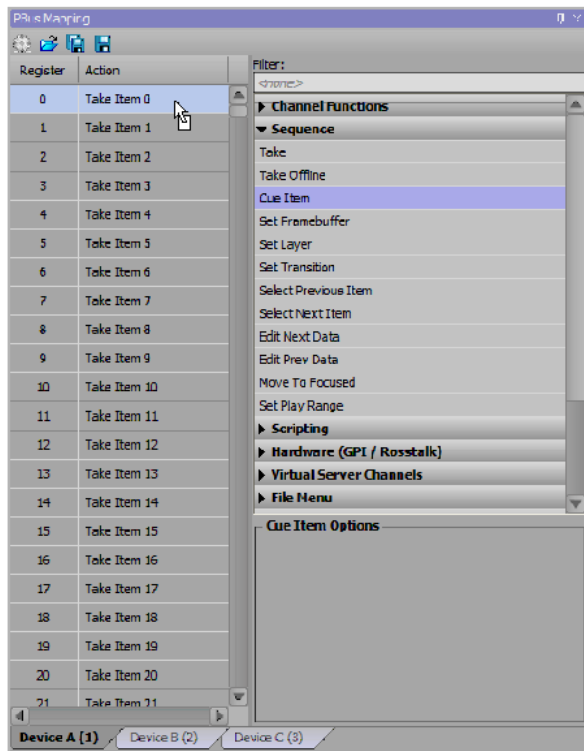

The action is added to the register.

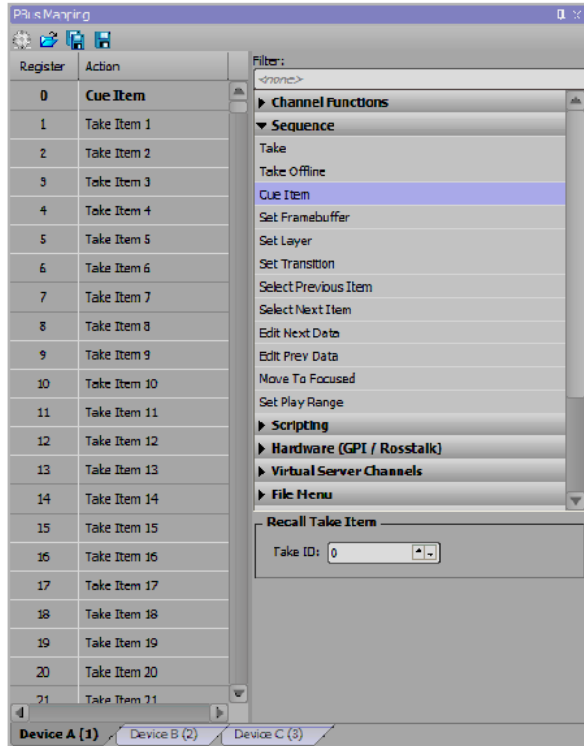

## Remapping a PBus Register

To remap a PBus register to play a different take item, the take item can be dragged and dropped from the sequencer onto the register in the PBus Mapping window or you can enter or select a different take ID using the **Take ID** box in the **Recall Take Item** section of the PBus Mapping window.

To remap a PBus register to play a different take item, the take item can be dragged and dropped from the sequencer onto the register in the **PBus Mapping** window or you can enter or select a different take ID using the **Take ID** field in the **Recall Take Item** section of the **PBus Mapping** window.

### To remap a PBus register using drag and drop from the Sequencer:

1. In the **Sequencer**, select a take item from the **Take ID** list.

Take ID	State	Scene	Name	Transition In / Out	Layer	Output	Start	End	Duration	GW
0300			Ross League							
0301		Scorebug	Scorebug	Cut / Cut	10	Framebuffer 1	00:00:00.00	00:00:02.00	00:00:02.00	
0302		Game VS	Game VS	Cut / Dissolve (10)	20	Framebuffer 1	00:00:00.00	00:00:06.20	00:00:06.20	
0303		Game VS - Sc...	Game VS - Scores	B Cut / Dissolve (10)	20	Framebuffer 1	00:00:00.00	00:00:06.20	00:00:06.20	
0304		Home - Player	Home - Player	1 Dissolve (5) / Dissolve (5)	0 (middle)	Framebuffer 1	00:00:00.00	00:00:03.01	00:00:03.01	
0305		Away - Player	Away - Player	D Dissolve (5) / Dissolve (5)	0 (middle)	Framebuffer 1	00:00:00.00	00:00:03.01	00:00:03.01	
0306		Home - Bio	Home - Bio	D Dissolve (5) / Dissolve (5)	0 (middle)	Framebuffer 1	00:00:00.00	00:00:03.01	00:00:03.01	
0307		Away - Bio	Away - Bio	D Dissolve (5) / Dissolve (5)	0 (middle)	Framebuffer 1	00:00:00.00	00:00:03.01	00:00:03.01	
0308		Home - Generic	Home - Generic	T Dissolve (5) / Dissolve (5)	0 (middle)	Framebuffer 1	00:00:00.00	00:00:03.01	00:00:03.01	
0309		Home - Tomb...	Home - Tombstone - Stats	D Dissolve (5) / Dissolve (5)	0 (middle)	Framebuffer 1	00:00:00.00	00:00:03.01	00:00:03.01	
0310		Home - Tomb...	Home - Tombstone - Bio	D Dissolve (5) / Dissolve (5)	0 (middle)	Framebuffer 1	00:00:00.00	00:00:03.01	00:00:03.01	
0311		Home - Tomb...	Home - Tombstone - Player	D Dissolve (5) / Dissolve (5)	0 (middle)	Framebuffer 1	00:00:00.00	00:00:03.01	00:00:03.01	
0312		Away - Tomb...	Away - Tombstone - Stats	D Dissolve (5) / Dissolve (5)	0 (middle)	Framebuffer 1	00:00:00.00	00:00:03.01	00:00:03.01	
0313		Away - Tomb...	Away - Tombstone - Bio	D Dissolve (5) / Dissolve (5)	0 (middle)	Framebuffer 1	00:00:00.00	00:00:03.01	00:00:03.01	
0314		Away - Tomb...	Away - Tombstone - Player	D Dissolve (5) / Dissolve (5)	0 (middle)	Framebuffer 1	00:00:00.00	00:00:03.01	00:00:03.01	
0315		Home - FS C...	Home - FS Compare	D Dissolve (5) / Dissolve (5)	0 (middle)	Framebuffer 1	00:00:00.00	00:00:02.21	00:00:02.21	
0316		Away - FS C...	Away - FS Compare	D Dissolve (5) / Dissolve (5)	0 (middle)	Framebuffer 1	00:00:00.00	00:00:02.21	00:00:02.21	
0317		Home - Playe...	Home - Player Spotlight	D Dissolve (5) / Dissolve (5)	0 (middle)	Framebuffer 1	00:00:00.00	00:00:02.21	00:00:02.21	
0318		Away - Playe...	Away - Player Spotlight	S Dissolve (5) / Dissolve (5)	0 (middle)	Framebuffer 1	00:00:00.00	00:00:02.21	00:00:02.21	
0319		VS - FS Com...	VS - FS Compare	T Dissolve (5) / Dissolve (5)	0 (middle)	Framebuffer 1	00:00:00.00	00:00:02.21	00:00:02.21	
0320		VS - FS Gam...	VS - FS Game Summary Hel...	T Dissolve (5) / Dissolve (5)	0 (middle)	Framebuffer 1	00:00:00.00	00:00:02.21	00:00:02.21	
0321		VS - FS Gam...	VS - FS Game Summary Hel...	T Dissolve (5) / Dissolve (5)	0 (middle)	Framebuffer 1	00:00:00.00	00:00:02.21	00:00:02.21	
0322		ROSS Wipe	ROSS Wipe	Cut / Cut	10	Framebuffer 1	00:00:00.00	00:00:06.20	00:00:06.20	
0323		Home - Wipe	Home - Wipe	Cut / Cut	10	Framebuffer 1	00:00:00.00	00:00:06.20	00:00:06.20	
0324		Away - Wipe	Away - Wipe	Cut / Cut	10	Framebuffer 1	00:00:00.00	00:00:06.20	00:00:06.20	
0325		Home - Radar	Home - Radar	H Dissolve (5) / Cut	0 (middle)	Framebuffer 1	00:00:00.00	00:00:20.00	00:00:20.00	
0326		Home - Pie	Home - Pie	H Dissolve (5) / Cut	0 (middle)	Framebuffer 1	00:00:00.00	00:00:20.01	00:00:20.01	
0327		Home - Noise	Home - Noise	M Cut / Cut	0 (middle)	Framebuffer 1	00:00:00.00	00:00:06.20	00:00:06.20	
0330		Home - Loud	Home - Loud	G Cut / Cut	0 (middle)	Framebuffer 1	00:00:00.00	00:00:06.20	00:00:06.20	

2. Drag and drop the take item onto a register in the **PBus Mapping** window.

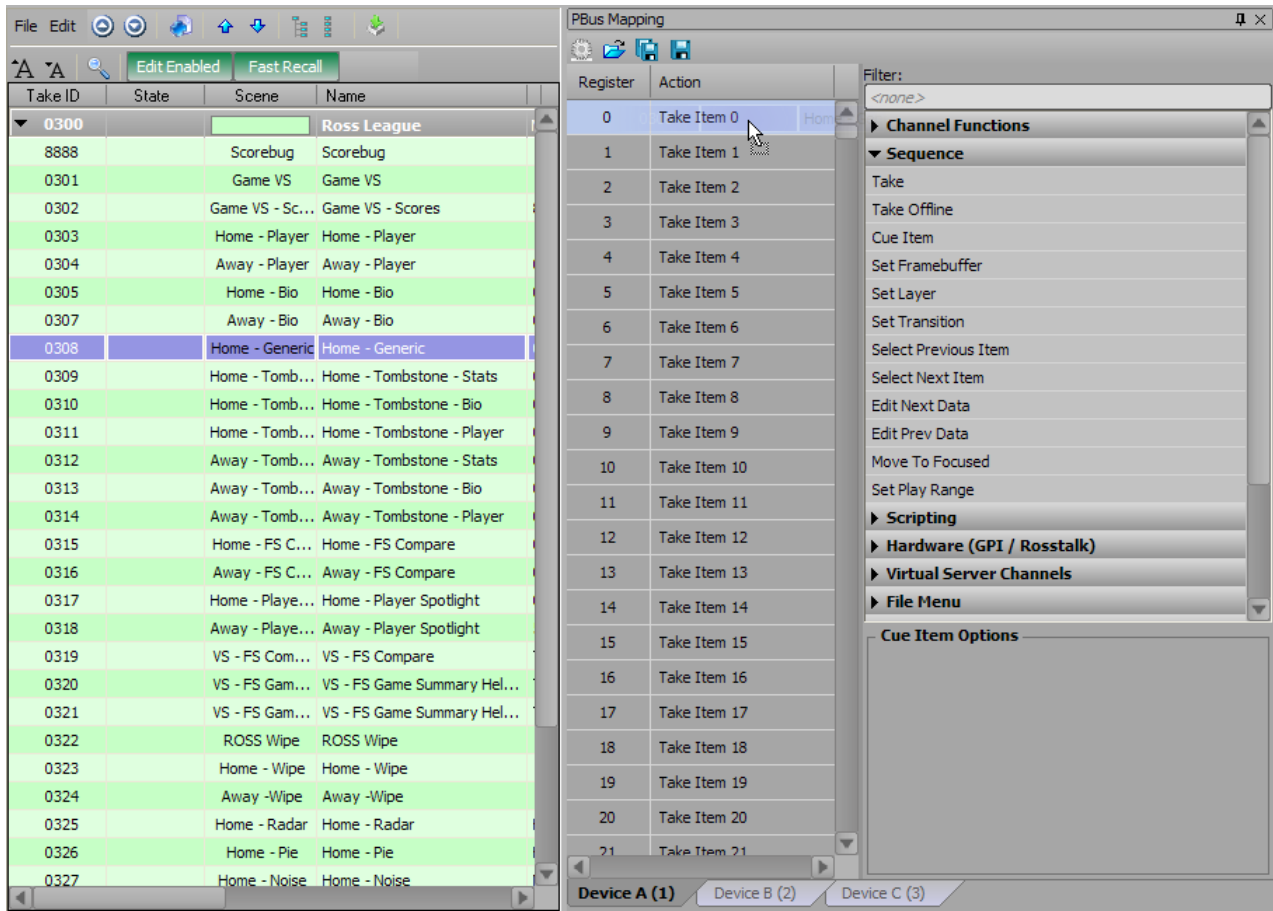

The take item is added to the register.

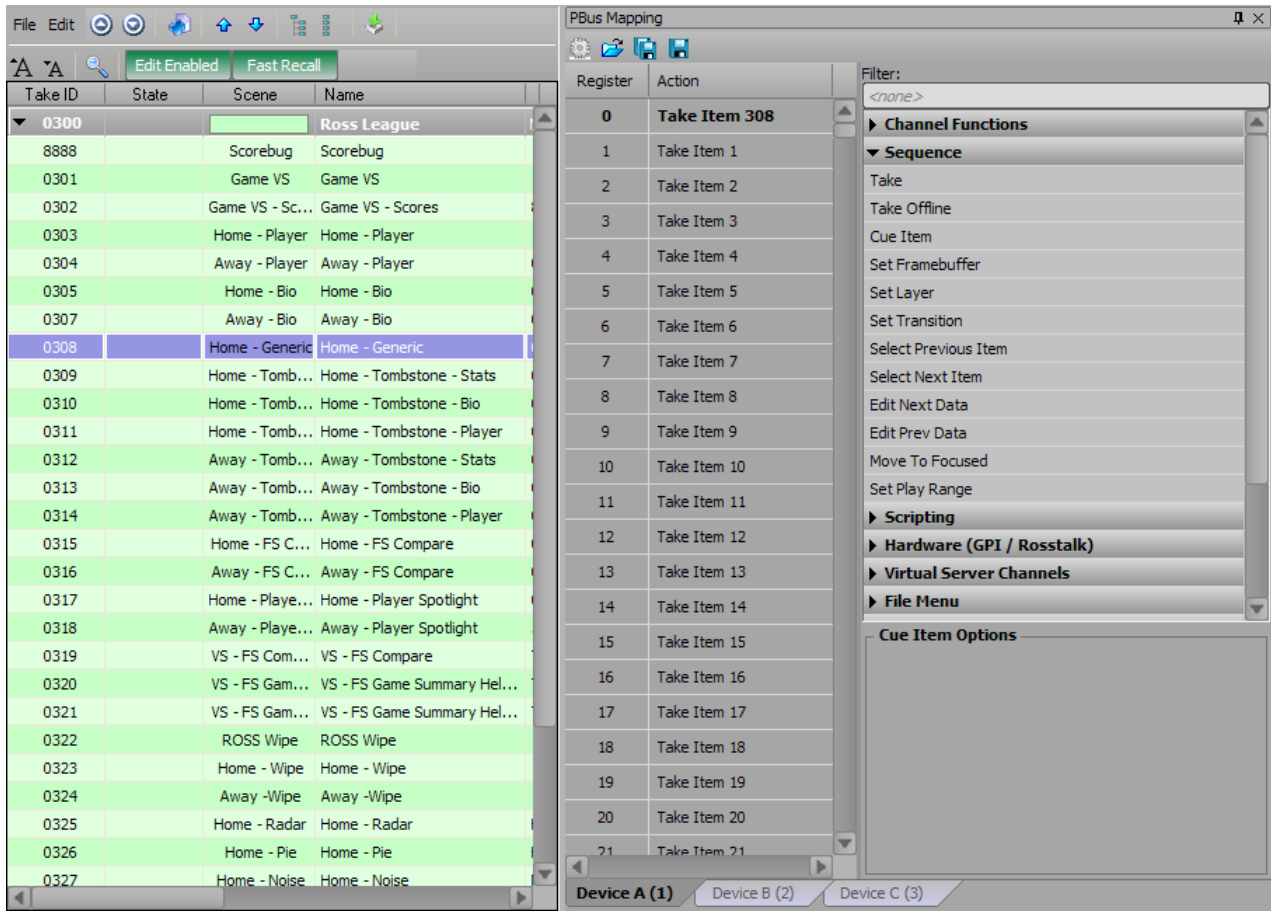

## To remap a register using the Take ID field:

1. In the **PBus Mapping** window, select a register number from the devices to the left of the actions list.

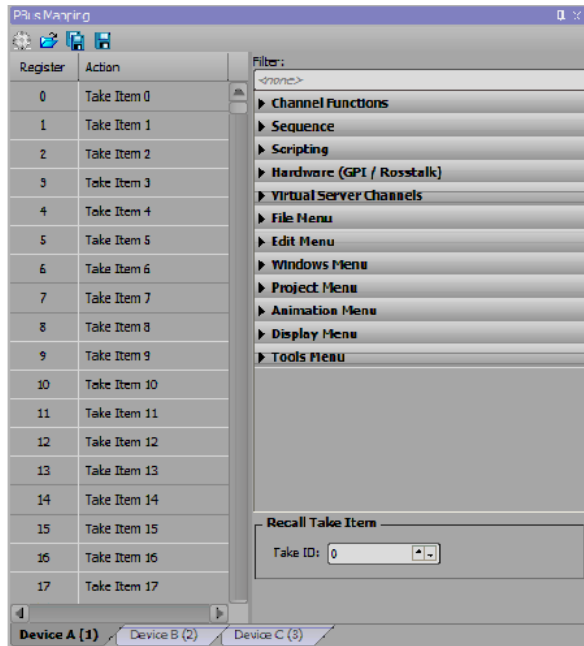

2. In the **Recall Take Item** section, in the **Take ID** field, enter or select a take item to add to the selected register.

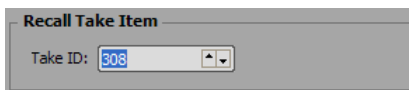

The take item is added to the selected PBus register.

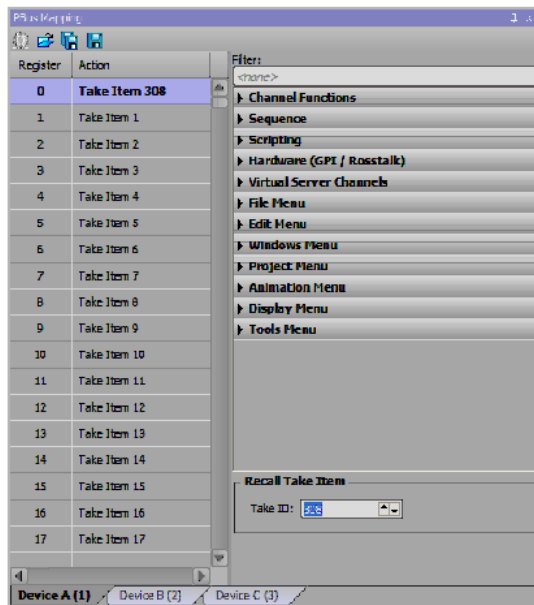

## Loading and Saving Maps

PBus maps are not loaded and saved with XPression projects. They are loaded and saved to disk as .pbm or .pbms files using the PBus Mapping window. The .pbm file extension is used for a single PBus map and the .pbms file extension is used for multiple PBus maps.

Use the following PBus Mapping window toolbar icons to load and save PBus maps:



**Load** — open a file browser to select a PBus map or multiple PBus maps to load.



**Save All** — save multiple PBus maps to disk.



**Save** — save a single PBus map to disk.

## Using PBus from a Switcher to Recall Items

★ Consult the switcher documentation for a complete description of how to use PBus with your particular manufacturer/model. This section is only intended to provide some background information and tips.

Normally switchers will send a PBus recall command when an EMEM is recalled. The following procedure is an example using take item 0005.

### To recall and play a specific take item from XPression:

1. In XPression, in the **Sequencer**, create a take item and give it an ID of **0005**.
2. Create an **EMEM/Memory** on the switcher and store it as **EMEM 5**.
3. Within **EMEM 5**, ensure that you have enabled the sending of PBus commands.
4. Within the timeline for **EMEM 5**, issue a **PBus Trigger 0** command.

When **EMEM 5** is recalled, it will send a PBus recall 5 command to XPression.

This command will not yet do anything (unless the configuration options discussed in the [Configuring the PBus Interface and PBus Recalls](#) section are enabled).

When the timeline is run, the switcher will send a **PBus Trigger 0** command. At this time, XPression will put take item #5 on the output channel/layer previously assigned to that item in the sequencer.

★ There may be several frames of delay between issuing the **Trigger 0** command and when the video for the item appears on the SDI output of XPression. This is normal and should be accounted for inside of the timeline on the switcher. For example, you will need a delay between the issuing of **Trigger 0** and when the keyer containing the XPression is keyed onto the PGM output.

5. To recall different take items, copy the timeline on the switcher into different switcher registers.

## Using PBus for XPression Clips

Firstly, the PBus configuration must be set to assign a PBus device ID to a specific server channel. This controls the server channel onto which PBus commands to a device will load the clip. Valid device IDs are from 0 to 23.

By default, every PBus register (0 to 4095) will cue/play the corresponding take item with that ID number. However, clips from the Clip Browser can be assigned to a PBus register simply by dragging them from the Clip Browser onto a PBus register. Alternatively, various actions (same ones accessible in the keyboard mapping menu) can be assigned to a PBus register by dragging them from the action list on the right to a PBus register. This is useful for assigning scripts or actions like Take Next/Clear Channel, etc. to a PBus register. Right-click on a register with a clip and select **Find Clip in Clip Browser** to find a clip or select a different clip in the Clip Browser.

A PBus register map can be saved to disk to a file using the .PBM extension, or maps for all devices can be saved to a .PBMS file. Maps can be loaded from these PBM files or from a specific format of XML file. When using the XML file import, it will assign clips to PBus registers using their recall ID from the clip database.

## Using PBus for XPression Clips with Recall IDs

The PBus map contains a column named **Recall ID**.

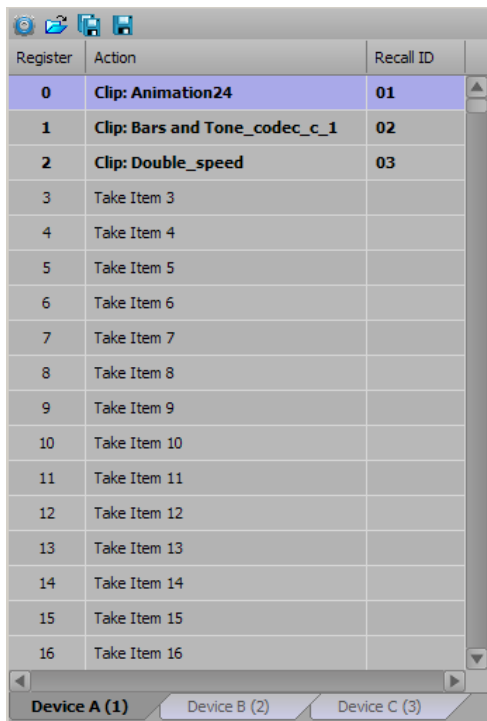

Register	Action	Recall ID
0	Clip: Animation24	01
1	Clip: Bars and Tone_codec_c_1	02
2	Clip: Double_speed	03
3	Take Item 3	
4	Take Item 4	
5	Take Item 5	
6	Take Item 6	
7	Take Item 7	
8	Take Item 8	
9	Take Item 9	
10	Take Item 10	
11	Take Item 11	
12	Take Item 12	
13	Take Item 13	
14	Take Item 14	
15	Take Item 15	
16	Take Item 16	

If a clip in the Clip Store exists with that recall ID, it will be assigned to that PBus register. A clip's recall ID can also be entered into the column to assign it to the respective register. The PBus register will always recall the clip with that specific recall ID, so if a new clip is ingested with a matching recall ID, the PBus register will recall the new clip instead. If the clip is manually edited and the recall ID is changed or removed, the PBus register will no longer recall that clip.

A similar behavior exists when dragging a clip with a recall ID into the PBus register; meaning that the PBus register is bound to a specific recall ID and not to a specific clip. Holding **Ctrl-Shift** and dragging a clip onto a PBus register will link the clip with the PBus register, and it will not be replaced regardless of a clip with a duplicate recall ID being ingested.

### For More Information on...

- PBus, refer to the *XPression User Guide* or **Help** file.

## Contact Us

Contact our friendly and professional support representatives for the following:

- Name and address of your local dealer
- Product information and pricing
- Technical support
- Upcoming trade show information

<b>Technical Support</b>	<b>Telephone:</b>	+1 613-686-1557 +1 833-859-0499 (Toll free within North America) +800 3540 3545 (Toll free International) 1300 007 677 (Australia/Sydney)* *If the local support specialist is not available, your call will be transferred automatically to our North America center.
	<b>Email:</b>	<a href="mailto:techsupport@rossvideo.com">techsupport@rossvideo.com</a>

<b>General Information</b>	<b>Telephone:</b>	+1 613-228-0688 +1 844-652-0645
	<b>Fax:</b>	+1 613-652-4425
	<b>Email:</b>	<a href="mailto:solutions@rossvideo.com">solutions@rossvideo.com</a>
	<b>Website:</b>	<a href="http://www.rossvideo.com">http://www.rossvideo.com</a>

## Visit Us

Visit our website for:

- Company information and news
- Related products and full product lines
- Online catalog
- Testimonials