ACO-4500 User Guide

Thank You for Choosing Ross

You've made a great choice. We expect you will be very happy with your purchase of Ross Technology. Our mission is to:

1. Provide a Superior Customer Experience
 - offer the best product quality and support
2. Make Cool Practical Technology
 - develop great products that customers love

Ross has become well known for the Ross Video Code of Ethics. It guides our interactions and empowers our employees. I hope you enjoy reading it below.

If anything at all with your Ross experience does not live up to your expectations be sure to reach out to us at solutions@rossvideo.com.



David Ross
CEO, Ross Video
dross@rossvideo.com

Ross Video Code of Ethics

Any company is the sum total of the people that make things happen. At Ross, our employees are a special group. Our employees truly care about doing a great job and delivering a high quality customer experience every day. This code of ethics hangs on the wall of all Ross Video locations to guide our behavior:

1. We will always act in our customers' best interest.
2. We will do our best to understand our customers' requirements.
3. We will not ship crap.
4. We will be great to work with.
5. We will do something extra for our customers, as an apology, when something big goes wrong and it's our fault.
6. We will keep our promises.
7. We will treat the competition with respect.
8. We will cooperate with and help other friendly companies.
9. We will go above and beyond in times of crisis. *If there's no one to authorize the required action in times of company or customer crisis - do what you know in your heart is right. (You may rent helicopters if necessary.)*

ACO-4500 · User Guide

- Ross Part Number: **4500DR-204-03**
- Release Date: April 6, 2020.

The information contained in this Guide is subject to change without notice or obligation.

Copyright

©2020 Ross Video Limited, Ross®, and any related marks are trademarks or registered trademarks of Ross Video Limited. All other trademarks are the property of their respective companies. PATENTS ISSUED and PENDING. All rights reserved. No part of this publication may be reproduced, stored in a retrieval system, or transmitted in any form or by any means, mechanical, photocopying, recording or otherwise, without the prior written permission of Ross Video. While every precaution has been taken in the preparation of this document, Ross Video assumes no responsibility for errors or omissions. Neither is any liability assumed for damages resulting from the use of the information contained herein.

Patents

Patent numbers US 7,034,886; US 7,508,455; US 7,602,446; US 7,802,802 B2; US 7,834,886; US 7,914,332; US 8,307,284; US 8,407,374 B2; US 8,499,019 B2; US 8,519,949 B2; US 8,743,292 B2; GB 2,419,119 B; GB 2,447,380 B; and other patents pending.

Notice

The material in this manual is furnished for informational use only. It is subject to change without notice and should not be construed as commitment by Ross Video Limited. Ross Video Limited assumes no responsibility or liability for errors or inaccuracies that may appear in this manual.

Safety Notices

Refer to the “**Important Regulatory and Safety Notices**” document that accompanied your product.

EMC Notices

United States of America FCC Part 15

This equipment has been tested and found to comply with the limits for a class A Digital device, pursuant to part 15 of the FCC Rules. These limits are designed to provide reasonable protection against harmful interference when the equipment is operated in a commercial environment. This equipment generates, uses, and can radiate radio frequency energy and, if not installed and used in accordance with the instruction manual, may cause harmful interference to radio communications. Operation of this equipment in a residential area is likely to cause harmful interference in which case the user will be required to correct the interference at their own expense.

Notice — *Changes or modifications to this equipment not expressly approved by Ross Video Limited could void the user's authority to operate this equipment.*

Canada

This Class “A” digital apparatus complies with Canadian ICES-003.

Cet appareil numérique de la classe “A” est conforme à la norme NMB-003 du Canada.

Europe

This equipment is in compliance with the essential requirements and other relevant provisions of CE Directive 93/68/EEC.

International

This equipment has been tested to CISPR 22:2009 and found to comply with the limits for a Class A Digital device.

Notice — *This is a Class A product. In domestic environments, this product may cause radio interference, in which case the user may have to take adequate measures.*

Maintenance/User Serviceable Parts

Routine maintenance to this Ross Video product is not required. This product contains no user serviceable parts. If the module does not appear to be working properly, please contact Technical Support using the numbers listed under the “Contact Us” section on the last page of this manual. This product is covered by a generous 4-year warranty. See the “Warranty and Repair Policy” section in this manual for details.

Environmental Information

The equipment that you purchased required the extraction and use of natural resources for its production. It may contain hazardous substances that could impact health and the environment.

To avoid the potential release of those substances into the environment and to diminish the need for the extraction of natural resources, Ross Video encourages you to use the appropriate take-back systems. These systems will reuse or recycle most of the materials from your end-of-life equipment in an environmentally friendly and health conscious manner.

The crossed out wheelee bin symbol invites you to use these systems.



If you need more information on the collection, re-use, and recycling systems, please contact your local or regional waste administration. You can also contact Ross Video for more information on the environmental performance of our products.

Company Address



Ross Video Limited

8 John Street
Iroquois, Ontario, K0E 1K0
Canada

Ross Video Incorporated

P.O. Box 880
Ogdensburg, New York
USA 13669-0880

General Business Office: (+1) 613 • 652 • 4886

Fax: (+1) 613 • 652 • 4425

Technical Support: (+1) 613 • 652 • 4886

After Hours Emergency: (+1) 613 • 349 • 0006

E-mail (Technical Support): techsupport@rossvideo.com

E-mail (General Information): solutions@rossvideo.com

Website: <http://www.rossvideo.com>

Contents

Introduction	11
Related Publications	11
Documentation Conventions	11
Interface Elements	11
User Entered Text	11
Referenced Guides	11
Menu Sequences	12
Important Instructions	12
Contacting Technical Support	12
Before You Begin	13
Features	14
Functional Block Diagram	14
Hardware Overview	15
Front Panel Overview	15
Rear Panel Overview	15
Physical Installation	17
Before You Begin	17
Static Discharge	17
Operating Environment Requirements	17
Unpacking	17
Accessories and Options	18
Standard Accessories	18
Rack Mount Installation	18
Installing the ACO-4500 into a Rack Unit	18
Installing the Rear Support Brackets	18
Connecting an SRG-4500 to an ACO-4500	19
Connecting the Primary SRG-4500 to the ACO-4500	19
Connecting the Backup SRG-4500 to the ACO-4500	20
Installing the Breakout PCB	20
Before You Begin	21
Installing the Breakout PCB on the Rack Tray	21
Installing the Breakout PCB into the Rack Frame	22
Cabling the Breakout PCB to the ACO-4500	23
Cabling the Connectors on the Breakout PCB	23
Connecting Power to the ACO-4500	24
AC Power Requirement	24
Connecting the Power Cable	24
Functional Check Procedures	25
Required Equipment	25
Before You Begin	25
Initial Power-Up	25
Initial Configuration	27
Performing Functional Checks	27
Normal Operation (No Faults)	28
Loss of the Primary Signal	28
Loss of Power	28
Operational Configuration	29

Power	29
Signals	29
Getting Started	31
General Usage	31
Launching DashBoard	31
Enabling a Connection in DashBoard	31
Accessing the ACO-4500 Interfaces in DashBoard	32
Operating Basics	32
Operating Mode	33
Fault Reporting	33
Front Panel Menu System	35
Navigating the Panel Menu System	35
Menu Trees	35
Main Menu	36
Operational Modes	36
Output	37
Other Menus	37
Signal Strength Menu	37
Channel # = POK X BOK X	38
Channel Configuration Menu	38
Installation Scenarios	39
Channel # Type	39
System Setup Menus	39
Temperature Reports	40
Event Report	40
System Report	42
Configuration Menu	43
Network Menu	44
DashBoard Menu	45
Calibration Menu	47
Changeover Channel	47
Do Calibration?	47
P NSig, B NSig	48
Troubleshooting	49
Troubleshooting Checklists	49
Replacing a Power Supply	49
Moving the Handle on the PS-4500	50
Removing the Front Faceplate	50
Removing the Failed PS-4500	51
Installing the New PS-4500	51
Re-install the Front Faceplate	51
Software Upgrades	51
Before You Begin	52
Uploading the Software Files	52
Technical Specifications	55
General Characteristics	55
Performance Conditions	55
BNC Channels	55
Balanced (Unmonitored Channels, Relay Changeover)	56
RS-232 Port	56
Ethernet Interface	56
AC Power Source	56

Clearance Requirements	57
Mechanical Characteristics	57
Environment Characteristics	57
Connector Pinouts	59
Balanced Signal Connectors	59
Pin Views of Connectors	60
RS232 Connector	60
Breakout Cable	60
Pin Views of Chassis Connectors	61
Calibration Procedure	63
Disclaimer	63
Calibrating the ACO-4500	63
Service Information	65
User Maintenance	65
General Care	65
Exterior Cleaning	65
Preventive Maintenance	65
Servicing	65
Service Safety Overview	66
Important Information Regarding the use of Switch Cleaners	66
Warranty and Repair Policy	66
In Case of Problems	67
Glossary	69

Introduction

This guide covers the installation, configuration, and use of the ACO-4500 Master Reference and Test Signal Generator. The following chapters are included:

- “**Introduction**” summarizes the guide and provides important terms, and conventions.
- “**Before You Begin**” provides a brief product overview and installation requirements for the ACO-4500.
- “**Hardware Overview**” describes the ACO-4500 hardware components.
- “**Physical Installation**” provides instructions for the basic physical installation of the ACO-4500.
- “**Getting Started**” outlines how to display the ACO-4500 interfaces in DashBoard, and how to
- “**Operation**” provides general information for operating the ACO-4500.
- “**Troubleshooting**” provides a basic troubleshooting checklist, steps for replacing a power supply, and a procedure for upgrading the software on the ACO-4500.
- “**Technical Specifications**” provides the specifications for the ACO-4500.
- “**Connector Pinouts**” lists the pinouts of various multi-way connectors on the ACO-4500 rear panel.
- “**Calibration Procedure**” provides an overview of how to calibrate your ACO-4500.
- “**Service Information**” provides information on the warranty and repair policy for your ACO-4500.
- “**Glossary**” provides a list of terms used throughout this guide.

Related Publications

It is recommended to consult the following Ross documentation before installing and configuring your ACO-4500:

- *DashBoard User Manual*, Ross Part Number: 8351DR-004
- *ACO-4500 Quick Start Guide*, Ross Part Number: 4500DR-202
- *SRG-4500 Quick Start Guide*, Ross Part Number: 4500DR-102
- *SRG-4500 User Guide*, Ross Part Number: 4500DR-104

Documentation Conventions

Special text formats are used in this guide to identify parts of the user interface, text that a user must enter, or a sequence of menus and sub-menus that must be followed to reach a particular command.

Interface Elements

Bold text is used to identify a user interface element such as a dialog box, menu item, or button. For example:

In the **Edit** dialog, click **Insert Above**.

User Entered Text

Courier text is used to identify text that a user must enter. For example:

In the **Language** box, enter **English**.

Referenced Guides

Italic text is used to identify the titles of referenced guides, manuals, or documents. For example:

For more information, refer to the *DashBoard User Manual*.

Menu Sequences

Menu arrows are used in procedures to identify a sequence of menu items that you must follow. For example, if a step reads “**File > Save As**,” you would select the **File** menu and then select **Save As**.

The term [**Confirm**] indicates that you should press the Rotary Control, and [**Back**] indicates that you should press the blue push-button.

Important Instructions

Star icons are used to identify important instructions or features. For example:

- ★ Contact your IT department before connecting to your facility network to ensure that there are no conflicts. They will provide you with an appropriate value for the IP Address, Subnet Mask, and Gateway for your ACO-4500.

Contacting Technical Support

At Ross Video, we take pride in the quality of our products, but if problems occur, help is as close as the nearest telephone.

Our 24-hour Hot Line service ensures you have access to technical expertise around the clock. After-sales service and technical support is provided directly by Ross Video personnel. During business hours (Eastern Time), technical support personnel are available by telephone. After hours and on weekends, a direct emergency technical support phone line is available. If the technical support person who is on call does not answer this line immediately, a voice message can be left and the call will be returned shortly. This team of highly trained staff is available to react to any problem and to do whatever is necessary to ensure customer satisfaction.

- **Technical Support:** (+1) 613-652-4886
- **After Hours Emergency:** (+1) 613-349-0006
- **E-mail:** techsupport@rossvideo.com
- **Website:** <http://www.rossvideo.com>

Before You Begin

The ACO-4500 is designed for high reliability Master Sync operations where two SRG-4500 units are provided as a fail-safe Primary and Backup pair. The ACO-4500 provides automatic fail over to the wide range of SRG-4500 reference signals.

The ACO-4500 provides user-selection of reference sources. Automatic changeover may occur upon fault detection in any active source.

The ACO-4500 is an in-line device without internal buffers. Switching for all channels is by mechanical relay. The ACO-4500 also provides internal termination for unswitched BNC inputs.

The ACO-4500 includes 12 channels in a 1U rack. Each BNC channel consists of a Primary Input, a Backup Input, and an Output. All BNC channel relays switch in unison upon fault detection in any active BNC channel, front-panel command, or remote command.

In conjunction with the BNC channels, there are a number of unmonitored secondary channels available on Molex® connectors. All secondary connector channel relays switch in unison upon fault detection in any active BNC channel, front-panel command, or remote command.

The ACO-4500 uses signal amplitude as the basis for error checking. You can configure each BNC channel to check for a different type of input. There is a selection of predefined checking levels relating to the various signals that are supported:

- No Measurement
- Color Black (no ancillary signals present, i.e. only Sync and Burst)
- Color Black + VITC (with one or some ancillary signals present)
- 600mV Tri Sync
- SD SDI - LOS
- HD SDI - LOS
- 3G SDI - LOS
- 1V 10MHz
- 1V Sub-carrier
- 1V AES
- 2V Pulses - LOS
- 4V Pulses - LOS

For the common signals, a fault is reported when the input signal level falls below a predetermined ratio of the nominal peak value. Visual fault indications appear on the front-panel display for signals from both the Primary and Backup SRG-4500s. These indications remain on until cleared by the operator.

For other signals, a simple “Loss Of Signal” (LOS) detection is performed.

The signal reference amplitudes used for fault detection are programmed during factory calibration. The ACO-4500 includes dual power supplies, which provide power supply failure redundancy.

Features

The ACO-4500 includes the following:

- 12 channels in 1U rack height
- All BNC channels are signal agnostic
- All BNC channels are measured on both Primary and Backup inputs
- Ethernet (100-BaseT) interface remote control
- No fans
- All Configuration settings performed through DashBoard
- Tight integration with SRG-4500

Functional Block Diagram

This section provides the functional block diagram that outlines the workflow of the ACO-4500.

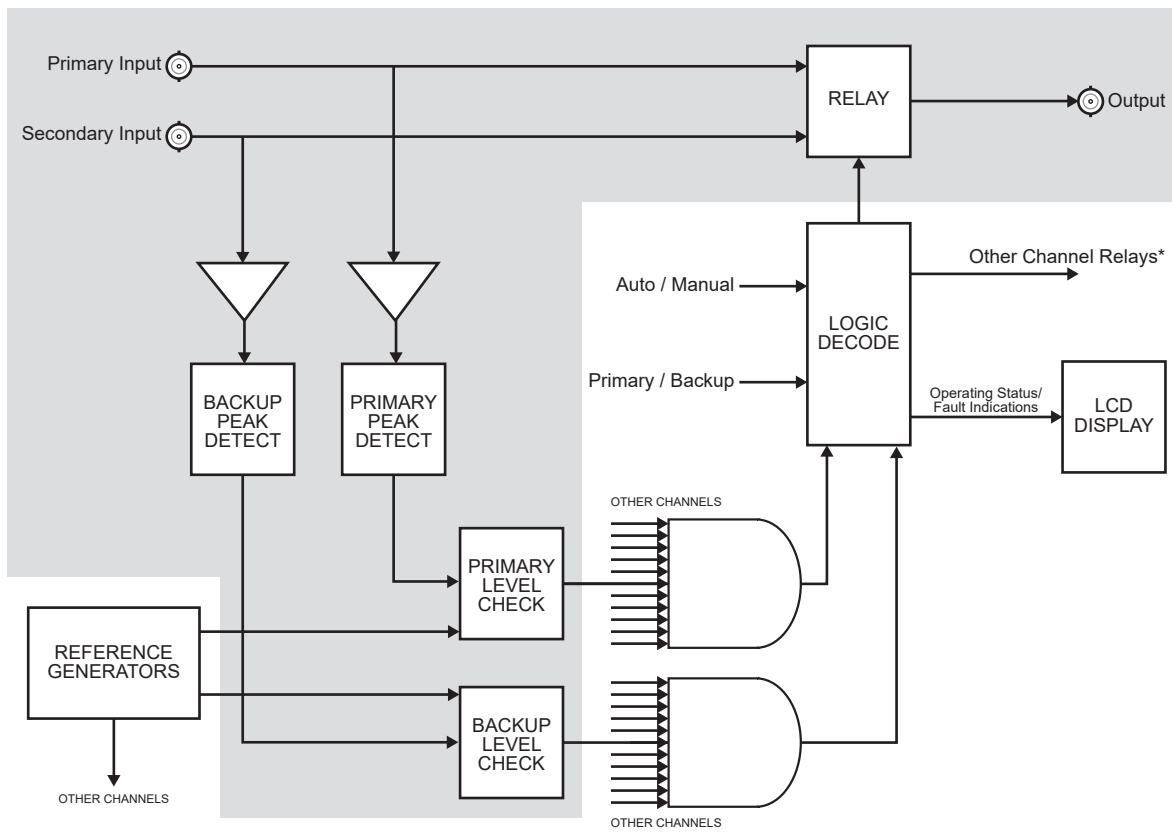

One of up to 12 channels

*Including unmonitored multi-way channels

Figure 2.1 ACO-4500 — Functional Diagram

Hardware Overview

This chapter presents information on the ACO-4500 front and rear panels.

Front Panel Overview

This section summarizes the controls and indicators located on the ACO-4500 front panel.

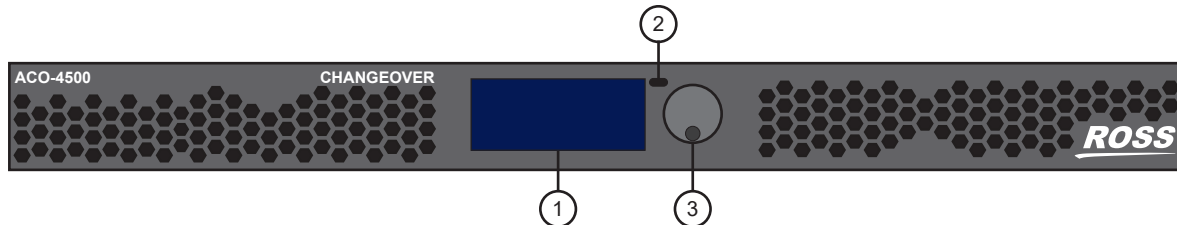

Figure 3.1 ACO-4500 — Front Panel Components

1. LCD Display

The dot-matrix LCD display is used to show system status, fault indications, and general in-use information, as well as being used to configure the menu system items.

2. Back Button

The Back push-button is used to exit the current menu screen, and to traverse back through the menus, ultimately to the stand-by screen.

Pressing the dedicated push-button once will exit the current menu level. When you have finished editing the menu options, you should use the dedicated push-button to exit the menu system completely. You need to press the button a suitable number of times to get back to the stand-by screen (the one with the Ross Video logo, one press back from the top level menu). This will save any changes that you have made to the non-volatile memory.

3. Rotary/Push Control Knob

The Rotary / Push control has two functions:

- › the rotary function is used to navigate up or down items in a menu, or to cycle through a range of values relating to a menu item,
- › the push function is used to confirm a menu item selection for editing, to exit menu item editing, or take you “forward” to the next menu item.

Selecting or editing menu items requires you to turn the Rotary Control in order to select or change the highlighted menu item / setting, then to press the Rotary Control to select or confirm that menu item / setting. Pressing the Rotary Control will select the highlighted menu item for editing, exit menu item editing, or take you to the next menu level. Note that there may be more menu lines available than can be displayed on the LCD screen; be sure to scroll down (or up) to find the required entry.

4. Removable Power Supplies (not shown)

There are two Removable Power Supply assemblies, installed and secured into the front of the ACO-4500, either side of the LCD display. These supplies can be removed or inserted while mains power is still present. Should it become necessary to replace one or both of the Removable Power Supply assemblies, the instrument does not have to be removed from the rack.

Rear Panel Overview

This section outlines the ACO-4500 rear panel connectors.

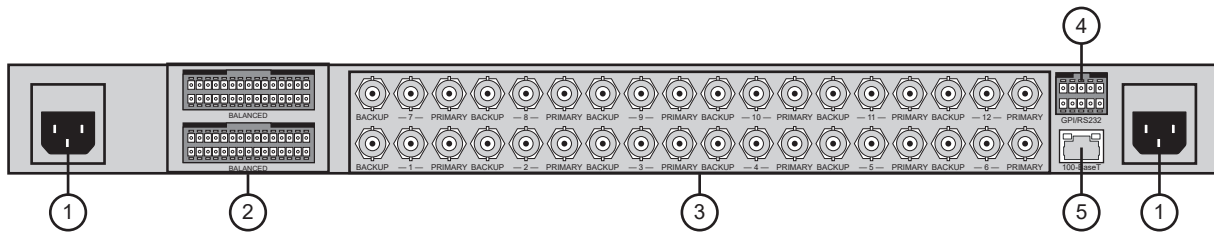

Figure 3.2 ACO-4500 — Rear Panel Components

1. Power Connectors

The ACO-4500 is designed to operate from a single-phase power source with the neutral conductor at or near earth ground. The line conductor is fused for over-current protection. A protective ground connection through the grounding conductor in the power cord is essential for safe operation. Safety earth studs are also provided for earth bonding the chassis if you so require.



Warning — To avoid the risk of electrical shock, do not operate the unit when the top cover is removed. Dangerous high voltages are present within the unit.

The ACO-4500 operates from an AC line frequency of 48Hz to 63Hz, over the range of 85VAC to 250VAC, without the need for user configuration. Refer to the chapter “**Technical Specifications**” on page 55 for additional information on power and environment requirements.

You need to provide two power connections, one for each power supply. For full power security, these should be on separate, independent and secure power grids. However, you still gain the security of power supply failure redundancy if you use the same power grid for both connections.

2. BALANCED Connectors

Three 30-pin Molex® connectors are present. These are unmonitored relay changeover channels that follow the BNC channels. Typical signals to connect here are those not supported via the BNC channels, such as Balanced Audio, Balanced Timecode, etc. The Molex® connectors are use for the following:

- › Top connector — input for the backup SRG-4500.
- › Middle connector — output of the ACO-4500.
- › Bottom connector — input for the primary SRG-4500.

3. BACKUP - # - PRIMARY BNCs

Each triplet of BNCs relates to one changeover channel, comprising of a Primary input, a Backup input, and an output.

- › **BACKUP** — An input from the Backup SRG-4500 is connected here. The signal applied must be the same format as the Primary.
- › **#** — The switched output from either the Primary input or the Backup input appears on the center BNC of each triplet. Which input appears here, and when, is determined by the configuration of the unit.
- › **PRIMARY** — An input from the Primary SRG-4500 is connected here. The signal can be any one of the supported types. The signal applied must be the same format as the Backup. If the channel is configured for “No Measurement”, almost any signal may be connected (the user must take into account, and be aware of, the limitations of the switching relay regarding voltage, current and signal bandwidth).

4. GPI / RS232

This rear-panel connector is a 10-pin male dual-in-line type. This allows for RS-232 communication, and GPI/O functionality. This port is not implemented.

5. 100-Base T

This rear-panel connector is a standard RJ45 Ethernet connector. This is used for DashBoard communication. After installation, it may be used to upload software updates.

Physical Installation

If you have questions pertaining to the installation of ACO-4500, please contact us at the numbers listed in the section “**Contacting Technical Support**”. Our technical staff is always available for consultation, training, or service.

For More Information on...

- the technical specifications for the ACO-4500, refer to the chapter “**Technical Specifications**” on page 55.

Before You Begin

Before installing the ACO-4500, refer to the document “**Important Regulatory and Safety Notices to Service Personnel**” that accompanied your unit for general safety information.

Static Discharge

Throughout this chapter, please heed the following cautionary note:



ESD Susceptibility — *Static discharge can cause serious damage to sensitive semiconductor devices. Avoid handling circuit boards in high static environments such as carpeted areas and when synthetic fiber clothing is worn. Always exercise proper grounding precautions when working on circuit boards and related equipment.*

Operating Environment Requirements

Keep the following in mind before installing the ACO-4500:

- Verify that the location of your installation has the proper operating environment. The ACO-4500 operates correctly in ambient temperatures from 0°C to +40°C and relative humidity from 20% to 80%.
- The ACO-4500 requires 2”(50mm) of side clearance for counter top use. Also, ensure sufficient rear clearance, e.g. 3”(75mm), so that cables are not compromised.
- The ACO-4500 does not currently have an internal fan to assist with ventilation or cooling. Therefore, when you install the unit in an equipment bay, it is imperative that you ensure there is sufficient space all around the unit to allow the airflow to vent away any excess heat generated by the unit.



Caution — *The ACO-4500 could be damaged if it is powered on at temperatures or humidities outside the specified ranges.*

For More Information on...

- environmental operating specifications, refer to the chapter “**Technical Specifications**” on page 55.

Unpacking

Unpack each ACO-4500 you received from the shipping container and ensure that all items are included. Initial Product Inspection

Perform the following when you receive your ACO-4500:

1. Inspect the shipping carton for external damage, which may indicate possible damage to the ACO-4500. If damage exists, document it, including photographs, to support any insurance claim.
2. Remove the instrument from the shipping carton.
3. Check that the ACO-4500 has not been damaged in transit. The exterior should not have any scratches or impact marks. Prior to shipment, the ACO-4500 is thoroughly inspected for mechanical defects.
4. Verify that the shipping carton contains the instrument, the standard accessories, and any optional accessories that you ordered.

- ★ If any items are missing or damaged, contact your sales representative or Ross Video directly.
- 5. Save the shipping carton and packaging materials for ACO-4500 re-packaging in case return shipment becomes necessary.
- 6. Perform the Functional Check Procedures as outlined in the chapter “**Functional Check Procedures**” on page 25 after installing the ACO-4500.

Accessories and Options

This section lists the standard accessories that ship with the ACO-4500 and the available software options that you can purchase.

Standard Accessories

The following accessories are shipped with the ACO-4500.

User Documentation Disc

A Documentation Resources disc was included with your ACO-4500.

Power Cords

All ACO-4500 are shipped with one of the following power cord options:

- Power cords for use in the United Kingdom are BS1363 approved.
- Power cords for use in North America are UL listed and CSA certified.
- Power cords for use in Europe conform to CEE7, DIN49441 and VDE standards.
- Cords for use in other areas are approved by at least one authority acceptable in the country to which the product is shipped.

Rack Mount Installation

You can install the ACO-4500 into an equipment rack. It is recommended to use the rack mount kit and to loom the cables so that they do not introduce extra weight or twisting force on the front panel rack mountings or rear panel connectors. If installed in a mobile application, the rack mount kit is essential.

This section describes how to install the ACO-4500 into the rack.



Warning — *To prevent the rack mounted ACO-4500 from tipping forward onto the operator, install the instrument so that the operator will be able to access all of its rear-panel connectors without pushing down on the instrument.*

Installing the ACO-4500 into a Rack Unit

The ACO-4500 mounts in the rack cabinet by means of four screws through the front mounting flanges. This should normally be sufficient to carry the load, including weight of cables. Refer to the *ACO-4500 Quick Start Guide* for mounting details.

Installing the Rear Support Brackets



Warning — *Do not use the support brackets to carry the ACO-4500. The brackets are not primarily designed for this purpose, and property damage or personal injury may result.*

In some cases, (mobile trucks, etc.) it may be desirable to also support the rear of the ACO-4500. The rear support bars can be attached to the ACO-4500 in six possible positions. (**Figure 4.1**)

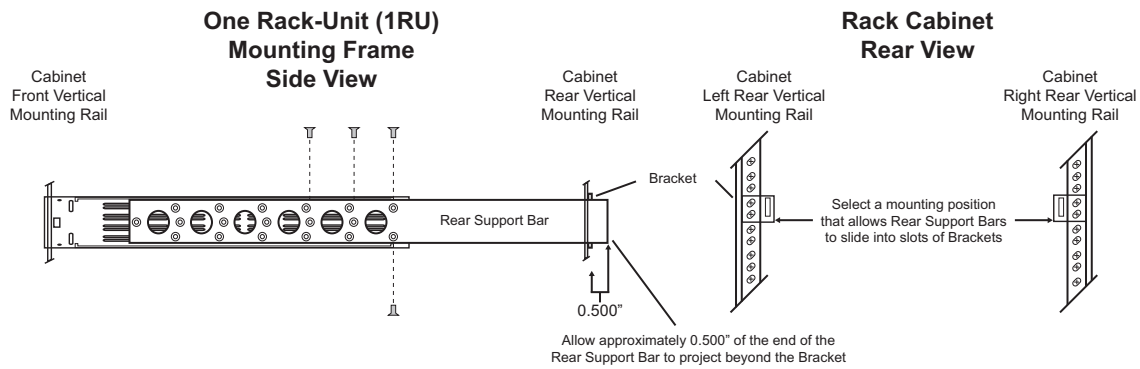

Figure 4.1 Installing the Support Brackets

To install the support brackets

1. Choose the position that suits the cabinet depth and will give approximately a 0.5” projection beyond the previously mounted bracket.
2. Using four screws per bracket, as shown in **Figure 4.1**, attach both bars.
3. Mount the frame to the front rails of the rack cabinet using rack screws.
4. At the rear of the cabinet, slide the bracket slots over the rear of the support bars and secure to the cabinet rear rails with rack screws.

Connecting an SRG-4500 to an ACO-4500

Each SRG-4500 (Primary and Backup) can connect directly to the ACO-4500 rear panel via an Interface Cable (4400CR-100-01). The Breakout PCB Kit that came with your SRG-4500 will be mounted and installed in the section

Connecting the Primary SRG-4500 to the ACO-4500

The Primary SRG-4500 connects directly to the ACO-4500 via its **BALANCED** connector and the Interface Cable (4400CR-100-01). This cable has red and violet wires, and two 30-pin Connectors.

To connect the Primary SRG-4500 to the ACO-4500

1. Connect one end of the Interface Cable (4400CR-100-01) to the **BALANCED** connector on the primary SRG-4500 rear panel.
2. Connect the other end of the same Interface Cable to the **bottom** 30-pin Connector on the ACO-4500 rear panel. Refer to **Figure 4.2**.

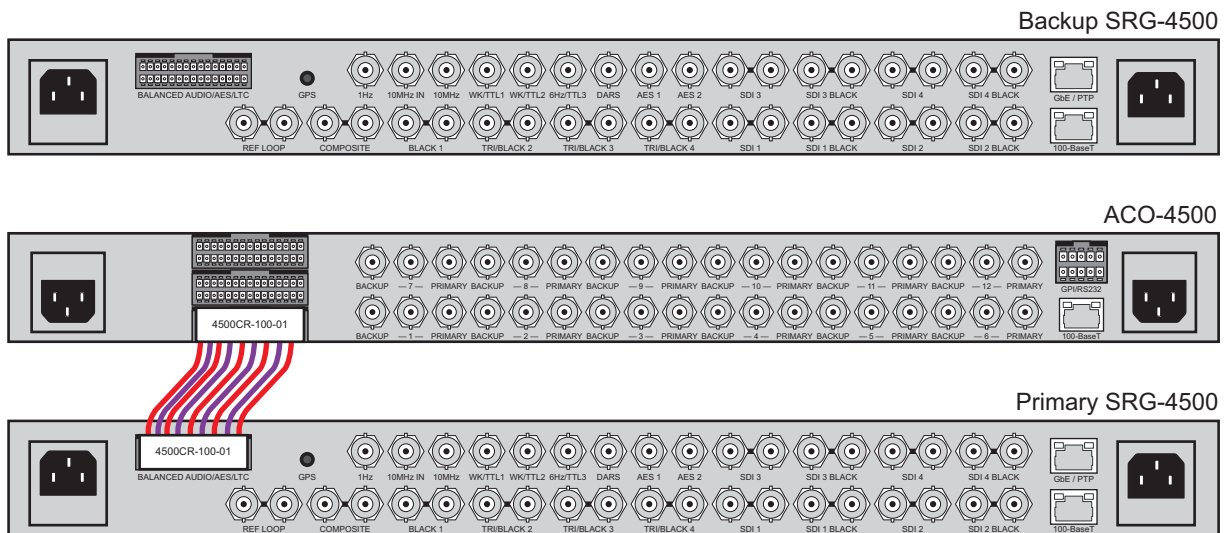

Figure 4.2 Connecting the Primary SRG-4500 to the ACO-4500 Rear Panel

Connecting the Backup SRG-4500 to the ACO-4500

The Backup SRG-4500 connects directly to the ACO-4500 via its **BALANCED** connector and a second Interface Cable (4400CR-100-01). This cable has red and violet wires, and two 30-pin Connectors.

To connect the Backup SRG-4500 to the ACO-4500

1. Connect one end of the Interface Cable (4400CR-100-01) to the **BALANCED** connector on the Backup SRG-4500 rear panel.
2. Connect the other end of the same Interface Cable to the top 30-pin Connector on the ACO-4500 rear panel. Refer to Figure 4.3.

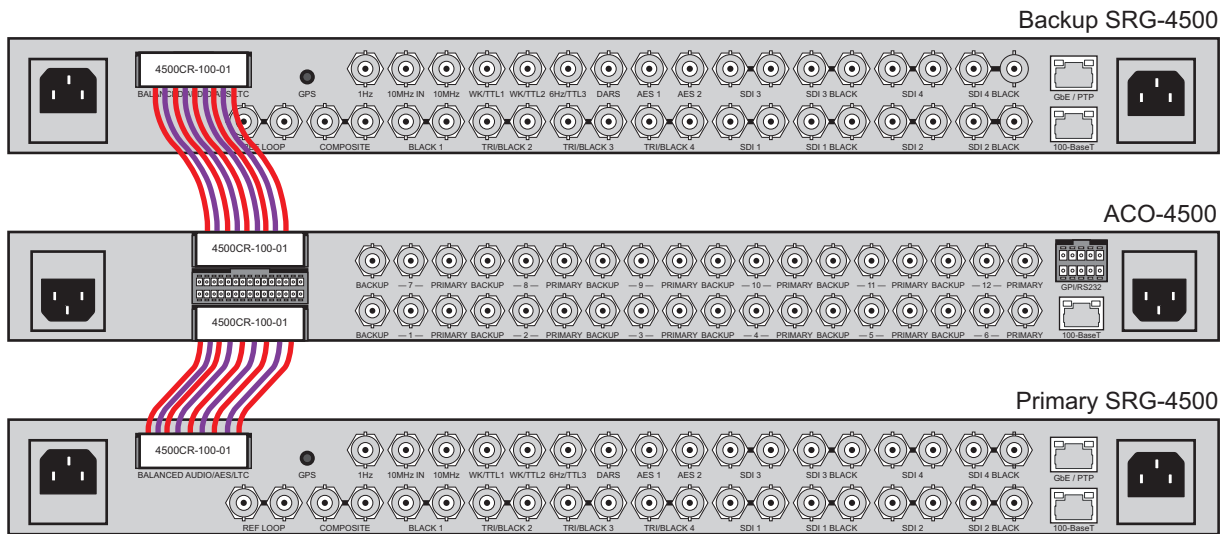

Figure 4.3 Connecting the Backup SRG-4500 to the ACO-4500 Rear Panel

3. Proceed to install the Breakout PCB as outlined in the next section.

Installing the Breakout PCB

This section provides instructions for installing the Breakout PCB with the ACO-4500, and within a redundant system of dual SRG-4500 units.

Installing the Breakout PCB requires:

1. Installing the Breakout PCB on the Rack Tray
2. Installing the Breakout PCB into the Rack Frame
3. Cabling the Breakout PCB to the ACO-4500
4. Cabling the Connectors on the Breakout PCB

Before You Begin

Before installing the Breakout PCB, refer to the document “**Important Regulatory and Safety Notices to Service Personnel**” that accompanied your unit for general safety information.

Static Discharge

Throughout this section, please heed the following cautionary note:



ESD Susceptibility — *Static discharge can cause serious damage to sensitive semiconductor devices. Avoid handling circuit boards in high static environments such as carpeted areas and when synthetic fiber clothing is worn. Always exercise proper grounding precautions when working on circuit boards and related equipment.*

Unpacking

Unpack each **SRG-4500 Install Kit** you received from the shipping container and ensure that all items are included. If any items are missing or damaged, contact your sales representative or Ross Video directly.

Required Equipment

Table 4.1 summarizes the items that are required

Table 4.1 SRG-4500 Install Kit Items

Part Number	Description	Quantity
70-00994	Rack frame tray for the Breakout PCB	1
8399AR-032	Breakout PCB	1
4101-3004-RC	5mm screws for the rear brackets and tray	8
88-00995	10mm screws with lock washers	4
4400CR-100	30pin Molex cable (red and violet wires)	3

Installing the Breakout PCB on the Rack Tray

The Breakout PCB for the ACO-4500 enables you to cable a Primary SRG-4500 and a Backup SRG-4500 to the ACO-4500 and provide access to the AES, DARS, and Analog Audio connections on balanced 3-pin connectors. You will need a Phillips screwdriver to affix the Breakout PCB to the rack tray using the four M3 10mm screws that were included in the **SRG-4500 Install Kit**.

For More Information on...

- installing the rear support brackets into the rack frame, refer to the section “**Rack Mount Installation**” on page 18.

To install the Breakout PCB on the rack tray

1. Position the Breakout PCB atop the screw posts on the tray. Refer to **Figure 4.4**.

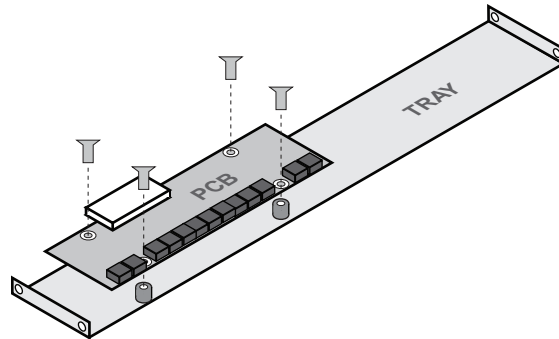

Figure 4.4 Installing the Breakout PCB on the Rack Tray

2. Affix the Breakout PCB using the provided four M3 10mm screws with lock washers (88-0095).

Installing the Breakout PCB into the Rack Frame

The Tray installs between the rear support brackets so that the 30-pin connector is aligned with the middle 30-pin connector on the ACO-4500 rear panel. This section outlines how to affix the tray to the rear support brackets.

To install the Breakout PCB in the rack frame

1. Position the Breakout PCB and Tray behind the ACO-4500 in the rack frame (**Figure 4.5**) while ensuring to:
 - a. position the Breakout PCB so that its white 30-pin connector is aligned with the ACO-4500 rear panel 30-pin connectors;
 - b. leave enough space between the ACO-4500 rear panel and the Breakout PCB to properly cable the connectors.

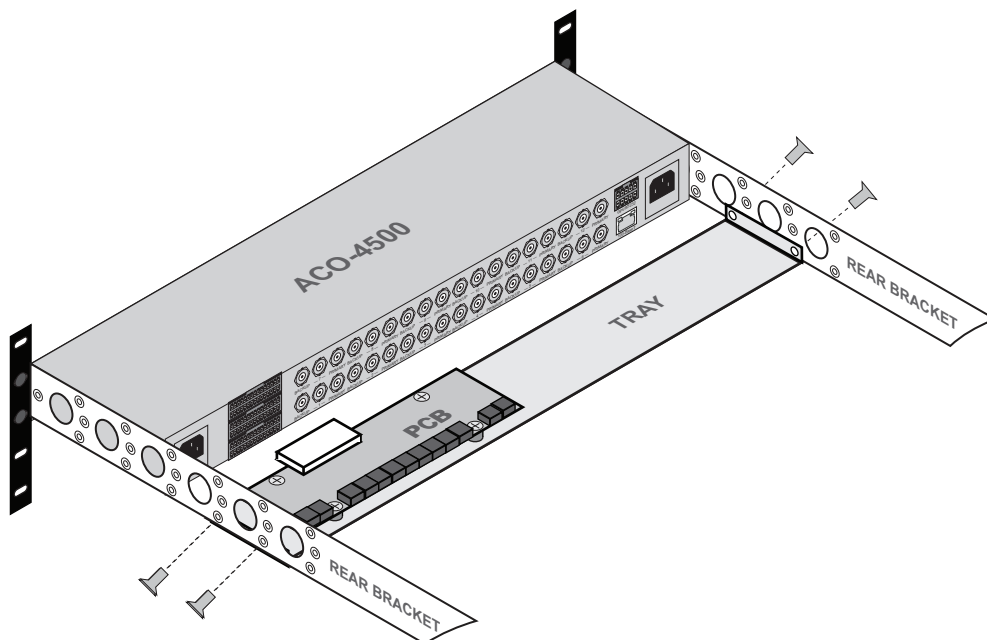

Figure 4.5 Installing the Breakout PCB and Tray to the Rear Brackets.

2. Use the 4 provided M3 5mm screws to affix the Breakout PCB and Tray to the Rear Brackets of the ACO-4500. Refer to **Figure 4.5**.

Cabling the Breakout PCB to the ACO-4500

The Breakout PCB connects to the ACO-4500 rear panel via the provided Interface Cable (4400CR-100-01) and the middle 30-pin on the ACO-4500 rear panel. This cable type has red and violet wires, and two 30-pin Connectors.

To connect the Breakout PCB to the ACO-4500

1. Connect one end of the Interface Cable to the connector on the Breakout PCB.

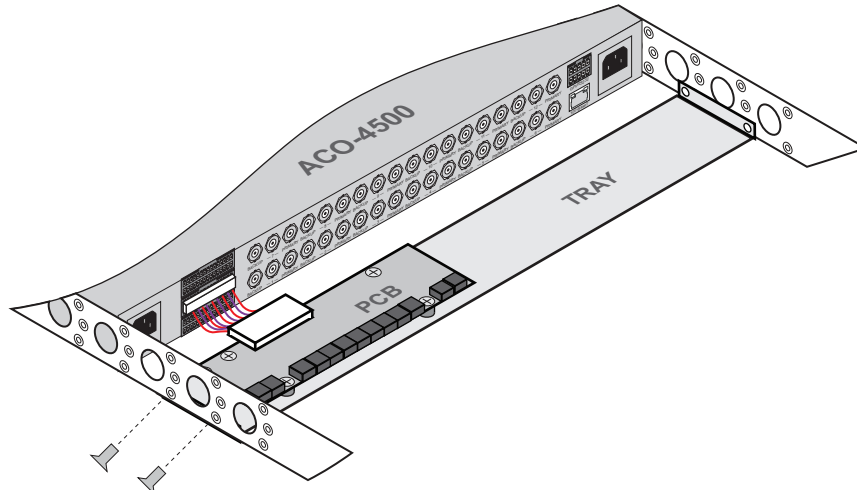

Figure 4.6 Connecting the Breakout PCB to the ACO-4500 Rear Panel

2. Connect the other end of the same Interface Cable to the middle 30-pin Connector on the ACO-4500 rear panel. Refer to **Figure 4.6**.

Cabling the Connectors on the Breakout PCB

The Breakout PCB provides a series of 3-pin terminal blocks with removable connectors that provide access to the AES, DARS, and Analog Audio connections. This section outlines the pinout designations and how to wire the 3-pin connectors.

Figure 4.7 illustrates the pinout assignment of the Breakout PCB 3-pin connectors. Each connector has locations for the positive, negative, and grounded wires. This information is also included in the PCB silk-screen.

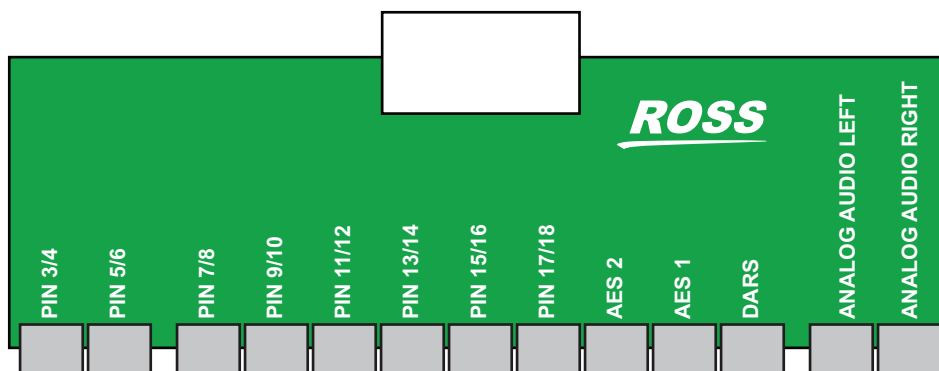

Figure 4.7 Breakout PCB — Top View of Connectors

For More Information on...

- the pinout assignments of the Breakout PCB 3-pin connectors, refer to the section “**Connector Pinouts**” on page 59.

To wire a 3-pin connector

1. Insert a wire to the designated polarity slot on the connector of the rear panel. **(Figure 4.8)**

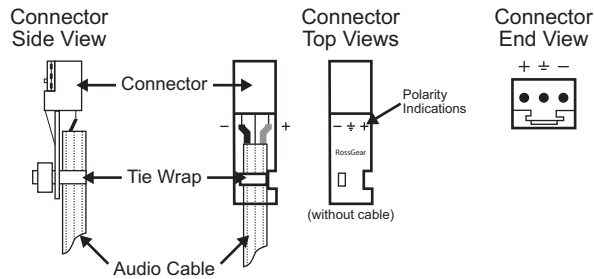

Figure 4.8 Connector Wiring for the Breakout PCB 3-pin Connectors

2. Use a tweaker screwdriver to tighten the corresponding capture screw.
3. Repeat steps 1 and 2 for each wire on each connector.
4. Once the cables are wired to the connectors, install the connectors on the terminal blocks of the Breakout PCB.

Connecting Power to the ACO-4500

The ACO-4500 operates from a single-phase power source with the neutral conductor at or near earth ground. The line conductor is fused for over-current protection. A protective ground connection through the grounding conductor in the power cord is essential for safe operation. Safety earth studs are also provided for earth bonding the chassis if you so require.

You need to provide two power connections. For full power security, these should be on separate, independent and secure power grids. However, you still gain the security of power supply failure redundancy if you use the same power grid for both connections.

AC Power Requirement

Check that your location provides the proper electrical power requirements as listed in **Table 4.2**.

Table 4.2 AC Line Power Requirements

Parameters	Description
Line Voltage Range	100-240V
Line Frequency	50-60Hz
Maximum Power (Dual PSU)	46VA (21W) - calculated <130mA @ 230V <200mA @ 120V Each PSU

Connecting the Power Cable

Connect the power cable to the instrument first, and then connect it to the AC power source. Note that connecting a live power cable causes the instrument to power on.



Caution — *The ACO-4500 does not have a power switch. Removing the power supply cord(s) disconnects the device from the mains power. Ensure easily accessible socket outlets are available near the ACO-4500 to power the unit.*



Caution — *If two entry connectors are preset on the rear panel, the ACO-4500 will still be powered until both power cords are removed.*

Functional Check Procedures

Perform the following procedures if you are operating the ACO-4500 for the first time (to verify that the ACO-4500 shipped without damage), or you suspect that the ACO-4500 is not working properly.

This chapter will guide you through the steps required to check the operation of the ACO-4500. The most common scenarios will be explored to enable the user to familiarize themselves with the operation of the unit:

1. Initial Power-Up
2. Initial Configuration
3. Normal Operation (no fault)
4. Loss and Restoration of a Primary Signal
5. Loss and Restoration of a Backup Signal
6. Loss and Restoration of Power

Only one channel will be considered here to avoid confusion. To check the whole unit, repeat this procedure for each of the remaining channels, remembering to leave signals connected to previously checked channels.

Because the unmonitored channels (on the 30-pin Molex® connectors) are secondary to the BNC channels, no specific details are listed in this procedure regarding their function. Simply connect suitable signals to the relevant connector pins, and monitor the signal changeovers happening at the same time as the BNC channels listed in the procedure below.

Required Equipment

The following equipment is required for the functional check:

- Video Test Signal Generator
- Multi-format waveform/picture monitors
- 75ohm BNC cables
- 75ohm terminations
- Breakout cable/box for the rear panel 30-way multi-way connector (not supplied by Ross Video)

Before You Begin

Although some steps are included which suggest cycling through menu options in order to check operation, this is not mandatory - a simple check for presence or absence of a signal will suffice.

For More Information on...

- the configurable menus and fields for the ACO-4500, refer to the chapter “**DashBoard Interface Overview**” on page 49.

Initial Power-Up

1. Ensure that the ACO-4500 is not powered on.
2. Connect the ACO-4500

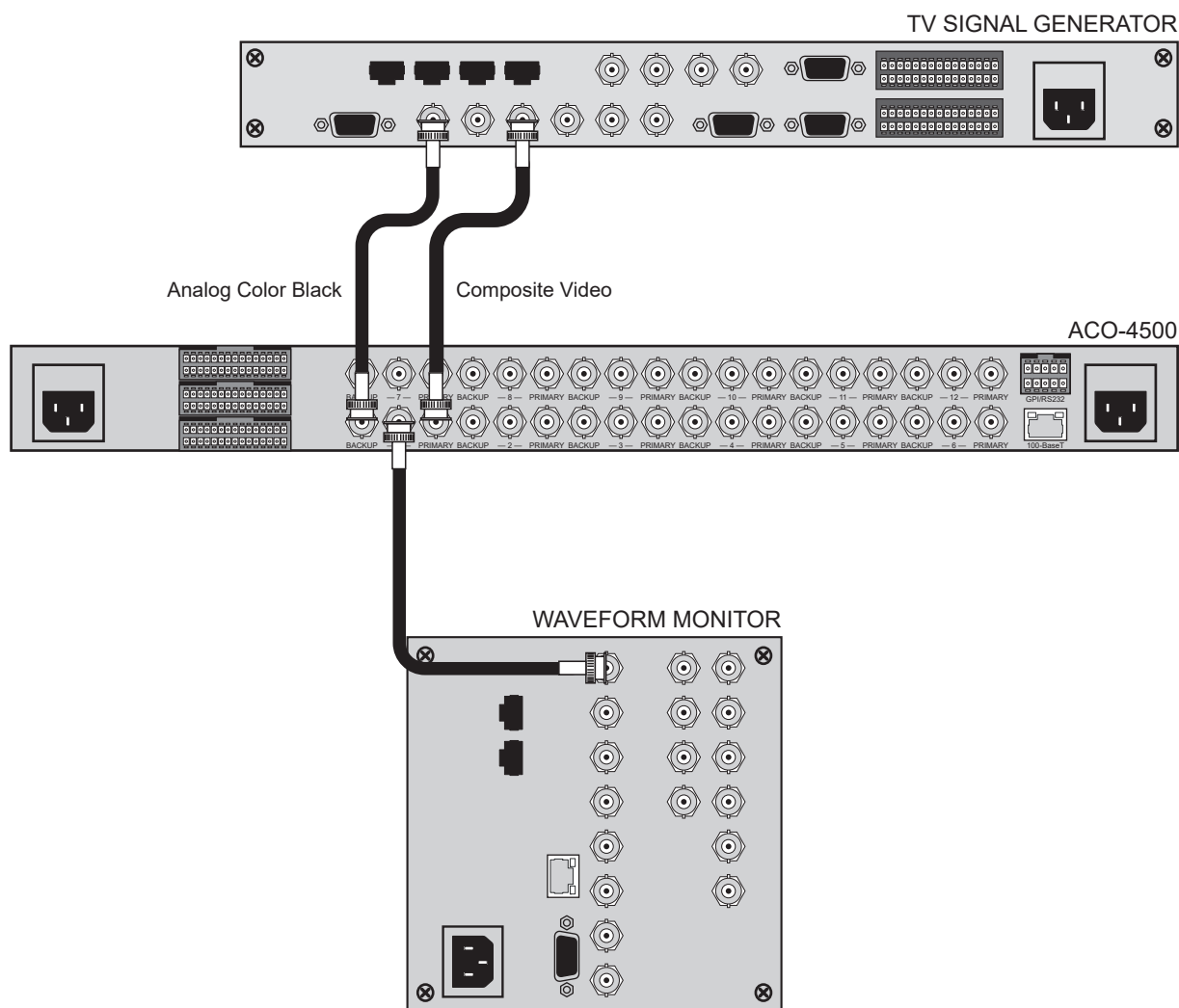

Figure 5.1 Functional Check — Initial Power-up Connections

3. Apply power to the ACO-4500 by connecting it to the power source(s). The instrument runs its power-on initialization process.
4. Check that no error messages appear on the LCD display.
- ★ You may see a message that relates to missing inputs. This will be because the ACO-4500 is configured to monitor more channels than you currently have signals connected. If you are sure that you want to cancel the message and continue with the procedure, press the **Rotary Control** once.
5. Much of the functional check can be carried out immediately. However, some calibration settings are only guaranteed once functional temperature has stabilized (which should occur after 20 minutes). It is good practice to soak the instrument before proceeding.
6. Selecting or editing menu items requires you to turn the Rotary Control in order to select or change the highlighted menu item / setting, then to press the Rotary Control to select or confirm that menu item / setting.
 - Pressing the Rotary Control will either select the highlighted menu item for editing, exit menu item editing, or take you to the next menu level.
 - Note that there may be more menu lines available than can be displayed on the LCD screen or video outputs; be sure to scroll down (or up) to find the required entry.

7. Pressing the blue push-button once will exit the current menu level or item.
 - When you have finished editing the menu options, you should use the blue push-button to exit the menu system completely.
 - You need to press the button a suitable number of times to get back to the stand-by screen (the one with the Ross Video logo). This will save any changes that you have made to the non-volatile memory.

Initial Configuration

The ACO-4500 should arrive configured to a “factory default” condition, i.e. all channels set for Type = Color Black, Operational Mode = Automatic, Output = Primary.

To ensure that you have a suitable channel configuration for the purposes of this Functional Check, you should perform the following procedures.

★ [Confirm] indicates that you should press the Rotary Control, and [Back] indicates that you should press the blue push-button.

To select the number of active channels

1. Verify that you are in the “Top Level” menu: “ACO-4500”.
2. Select < - System Setup >.
3. [Confirm]
4. Select the System Setup Menu.
5. Highlight < - Configuration >.
6. [Confirm]
7. Highlight < Number of channels >.
8. [Confirm]
9. Set the number of channels. For initial configuration, select 1 channel.
10. [Confirm]
11. Select [Back] twice to return to the “Top Level” menu.

To select the channel type(s)

1. Verify that you are in the “Top Level” menu: “ACO-4500”.
2. Highlight < -Channel Setup >.
3. [Confirm]
4. Select the Channel Configuration Menu.
5. Highlight the channel to change. For initial configuration, select Channel 1.
6. [Confirm]
7. Select the channel type. For initial configuration, select Color Black.
8. [Confirm]
9. Select [Back] to return to the “Top Level” menu.

Performing Functional Checks

Note that in the following procedures, some intermediate instructions relating to cursor movements and control button presses are omitted for clarity.

Normal Operation (No Faults)

From the “Top Level” menu:

1. Check / Set “Operational Mode” = < Auto >. This is the default at power-up if no faults are detected.
2. Check / Set “Output” = < Primary >. This is the default at power-up if no faults are detected).

You should see that the channel output is the Primary input signal (Composite Video).

★ You cannot select “Output = Backup” when the Operational Mode is set to “Auto”.

3. Select “Operational Mode” = < Manual >. Select “Output” = < Backup >. The channel output switches to the Backup input signal (Analog Color Black).
4. Select “Output” = < Primary >. The channel output switches to the Primary input signal (Composite Video).
5. Select “Operational Mode” = < Auto >.

Loss of the Primary Signal

From the “Top Level” menu:

1. Press the [Back] button once to enter the Stand-By screen - “Ross Video” Logo.
2. Disconnect the Primary input signal (Composite Video).

★ The channel output automatically switches to the Backup input signal (Analog Color Black), and a fault indication appears on the display.

3. Re-connect the Primary input signal (Composite Video). Note that the fault indication changes to show that the Primary input signal is now correct, and the channel output automatically switches back to the Primary input signal (Composite Video).
4. Press [Confirm] to clear the fault indication.
5. Select “Operational Mode” = < Manual >.
6. Press [Back] to go to the Stand-By screen.
7. Disconnect the Primary input signal (Composite Video). Note that no switching occurs, but that the Primary fault indication appears.
8. Press [Confirm] to clear the fault indication.
9. Select “Output” = < Backup >. The channel output switches to the Backup signal (Analog Color Black).
10. Re-connect the Primary input signal (Composite Video).
11. Select “Output” = < Primary >. The channel output switches to the Primary input signal (Composite Video).
12. Select “Operational Mode” = < Auto >.

Loss of Power

1. Turn off the power to one of the mains inlets. The associated fault indication appears in the display.
2. Restore power to the mains inlet. The fault indication changes to show that the “fault” is fixed.
3. Turn off the power to the other mains inlet. The associated fault indication appears in the display.
4. Restore power to the mains inlet. The fault indication changes to show that the “fault” is fixed.
5. Turn off the power to both mains inlets. The channel output changes to the Primary input signal (Composite Video) and the unit powers down.

Operational Configuration

There are several configuration factors that will influence the initial installation of your ACO-4500. The following guidelines outline a typical example.

Power

The ACO-4500 will automatically switch to the Primary inputs whenever it loses power. So, you should connect the Backup SRG-4500 and one mains input on the ACO-4500 to the same power source, and connect the Primary SRG-4500 (and the second mains input on the ACO-4500) to a second power source. In these configurations, both power connections would have to fail before you lose control of the ACO-4500.

Signals

You should now configure the ACO-4500 according to your requirements, namely the number of channels to be monitored, and the signal type associated with each channel (using the procedures detailed in the previous Initial Configuration section of this manual). When finished, remember to exit the Menu system properly to save your settings in non-volatile memory.

When selecting the number of channels, you must always start from number 1, and continue up to the number of signals you wish to monitor. You should set any unused channels to “No Measurement”. If you select more active channels than you have signals connected, “Input Missing” errors will always be reported, leading to inconsistent operation.

You can now connect your signals to the ACO-4500 rear panel BNCs according to the configuration settings made in the previous paragraph. The example in **Figure 5.2** shows six channels from the list of supported signal types but does not illustrate Molex® channels. Note that the maximum is 12 channels.

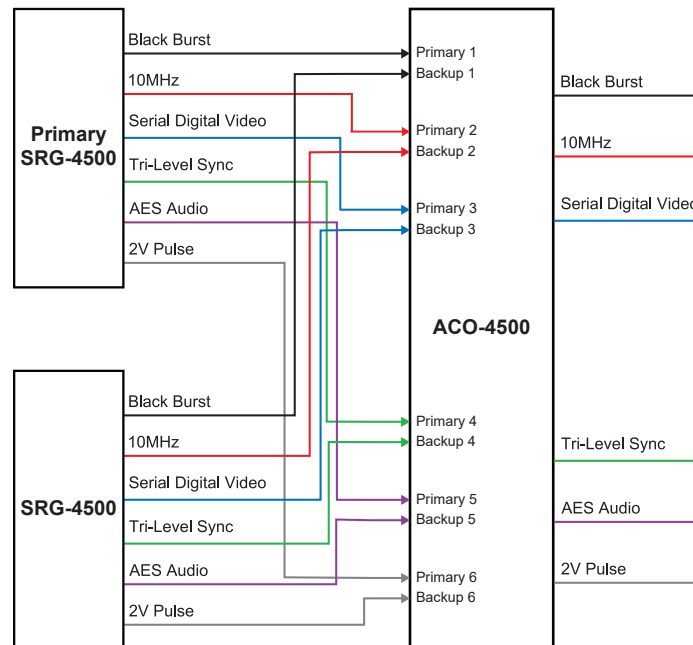

Figure 5.2 Example of ACO-4500 Connections

You should produce a master reference sheet, in order to log how each channel is configured and connected (an example is shown below in **Table 5.1**). This will be helpful to refer to in the future in order to quickly find out whether, for example, a previously unused channel requires a menu change relating to the new signal to be monitored.

Table 5.1 ACO-4500 Channel Configuration

Channel	Channel Type	Signal Attached
1		
2		
3		
4		
5		
6		
7		
8		
9		
10		
11		
12		

Getting Started

The ACO-4500 can be remotely controlled over an ethernet link by a DashBoard client.

This chapter provides instructions for launching DashBoard and accessing the tabs and menus in DashBoard for the ACO-4500.

General Usage

Keep the following in mind when using DashBoard to communicate with the ACO-4500:

- The ACO-4500 is always configured as a fixed IPv4 device using the menu system accessible on the front panel.
- The menu structure is System Setup menu > Network menu.
- The items to be configured are: IP Address, Subnet Mask, and Gateway. Contact your IT Department to help set these up.
- The controlling DashBoard client is expected to be on the same subnet as the ACO-4500.

Launching DashBoard

DashBoard must be run on a computer that has a physical wired ethernet connection.

For More Information on...

- downloading and installing the DashBoard client software, refer to the *DashBoard User Manual*.
- the ACO-4500 interfaces in DashBoard, refer to the chapter

To launch DashBoard

1. Ensure that you are running DashBoard software version 8.3.0 or higher.
2. Launch DashBoard by double-clicking its icon on your computer desktop.

Enabling a Connection in DashBoard

To enable DashBoard to communicate with the ACO-4500

1. Launch the DashBoard application on your computer.
2. From the Basic Tree View toolbar, select .
The **New Connection** dialog opens.
3. Select **TCP/IP openGear Frame** from the provided list.
4. Click **Next >**.

The New TCP openGear Frame Connection dialog opens.

5. Type the IP address of the ACO-4500 in the **IP Address** field.
6. Type a unique name for the ACO-4500 in the **Display Name** field. This name makes the ACO-4500 easily identifiable in the Tree View.
7. Click **Finish**.
8. Verify that the ACO-4500 is now listed in the Tree View.

Once a connection is established, a “ping” command can be issued on the computer running the DashBoard client. This is not required but is a useful diagnostic.

- If the ping fails, then the network route is not available. This indicates a basic network architecture failure. Contact your IT Department.
- If the ping is successful, then a DashBoard connection should be possible.

Accessing the ACO-4500 Interfaces in DashBoard

The interfaces are accessed by double-clicking the ACO-4500 node in the DashBoard Tree View. This procedure assumes that you have launched DashBoard on your computer.

To access the ACO-4500 interfaces in DashBoard

1. In the Basic Tree View of DashBoard, locate the ACO-4500 node.
2. Expand the ACO-4500 node.
3. Double-click a sub-node to display the ACO-4500 interface in the right pane of the DashBoard window.

In the example below, the user selected the Slot 1 sub-node.

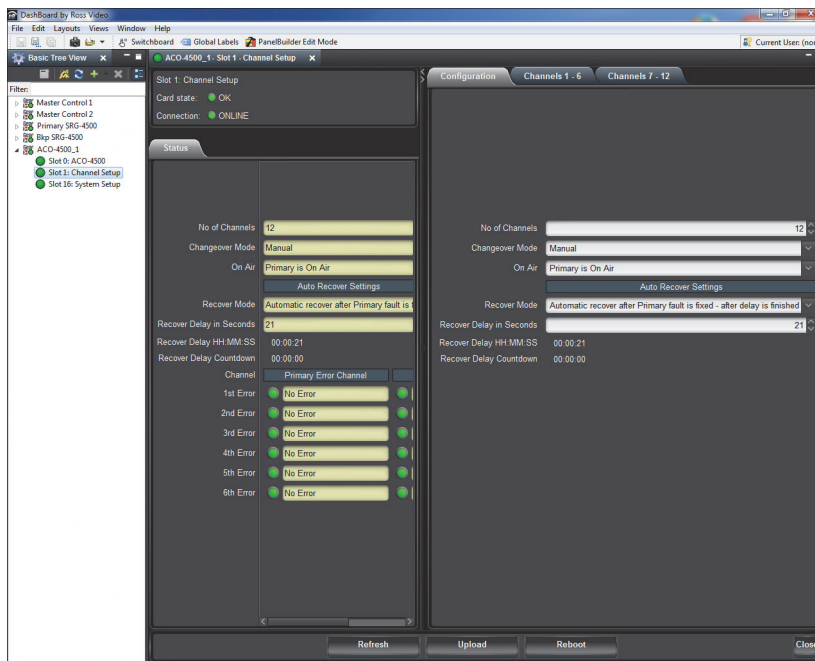

4. Select a tab to display its options in the right-side of the DashBoard window.

In the example above, the user selected the Configuration tab.

Operating Basics

The ACO-4500 can be thought of as an automatic multi-pole switch that actuates whenever an error is detected in any BNC signal channel. All channels will switch at the same time.

Any unused BNC input channel should be configured to disable error checking. If unused channels are not disabled, they will always produce error signals leading to improper operation.

Error threshold levels are pre-defined during initial testing, and are not adjustable.

Operating Mode

The ACO-4500 can be operated in one of two modes, selected from within the menu system. The options are either Auto or Manual control.

- **Auto** — the ACO-4500 will automatically switch if a fault is detected.
- **Manual** — the ACO-4500 will switch only when the operator manually selects between Primary and Backup.

Fault Reporting

There is an LCD indication for fault reporting on all channels. If a fault occurs in one of the configured channels on either the Primary or Backup input, the LCD indicator will illuminate to report the fault. The fault reporting is persistent, i.e. even if the fault is only an intermittent one, the fault indicator will stay illuminated. If more than one fault exists, only the “first” one is reported, i.e. counting from the lowest numbered configured channel. As faults are repaired, the fault indicator displays the next faulty input/channel in the list, etc. Repairing the last fault will update the LCD display to show that the [last] fault has been fixed - clearing the fault indication will turn the LCD fault indication off.

Front Panel Menu System

The ACO-4500 provides the user with a menu interface on the chassis to control the functions and options of the unit.

Navigating the Panel Menu System

The menus can always be viewed on the front panel LCD display, and optionally “in-vision” in an on-screen-display (OSD) viewable on any pattern output. By default, the OSD is set On for each pattern output, but can be independently disabled if desired.

The menus are accessed from the initial start-up (Time) screen by pressing the rotary control. To return to the Time screen, press the blue escape/back button. If you repeatedly press the blue button, the LCD display will cycle between the display of time and the display of logo.

The Logo menu reports the Device Name, IP Address (when connected), and the Software version number.



Figure 7.1 Example of the Logo Screen

This menu also gives you access to the key menus that are used to control and configure the ACO-4500: Signal Strength, the Channel Setup, and the System Setup menus.

Menu Trees

Figure 7.2 is a basic menu tree structure of the ACO-4500.

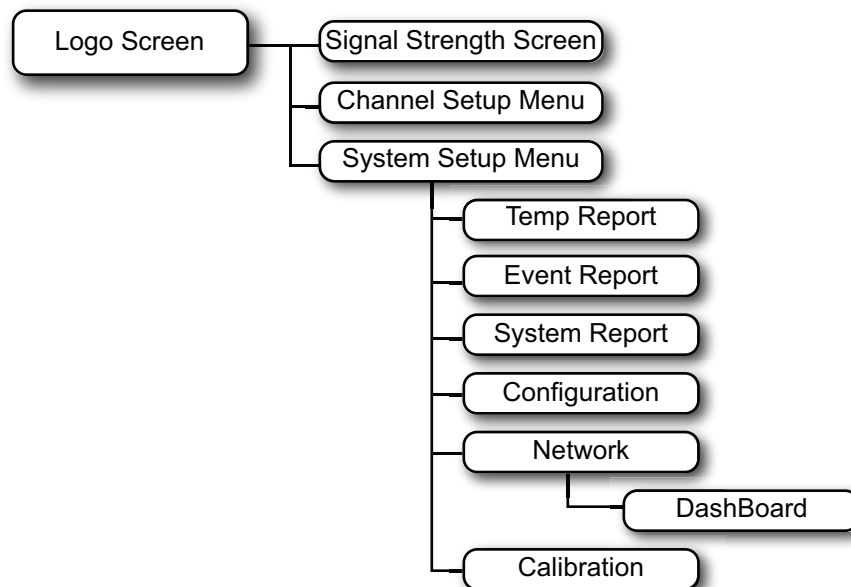

Figure 7.2 ACO-4500 — Menu Tree (Diagrammatic)

Figure 7.3 provides a quick reference of the menu system.

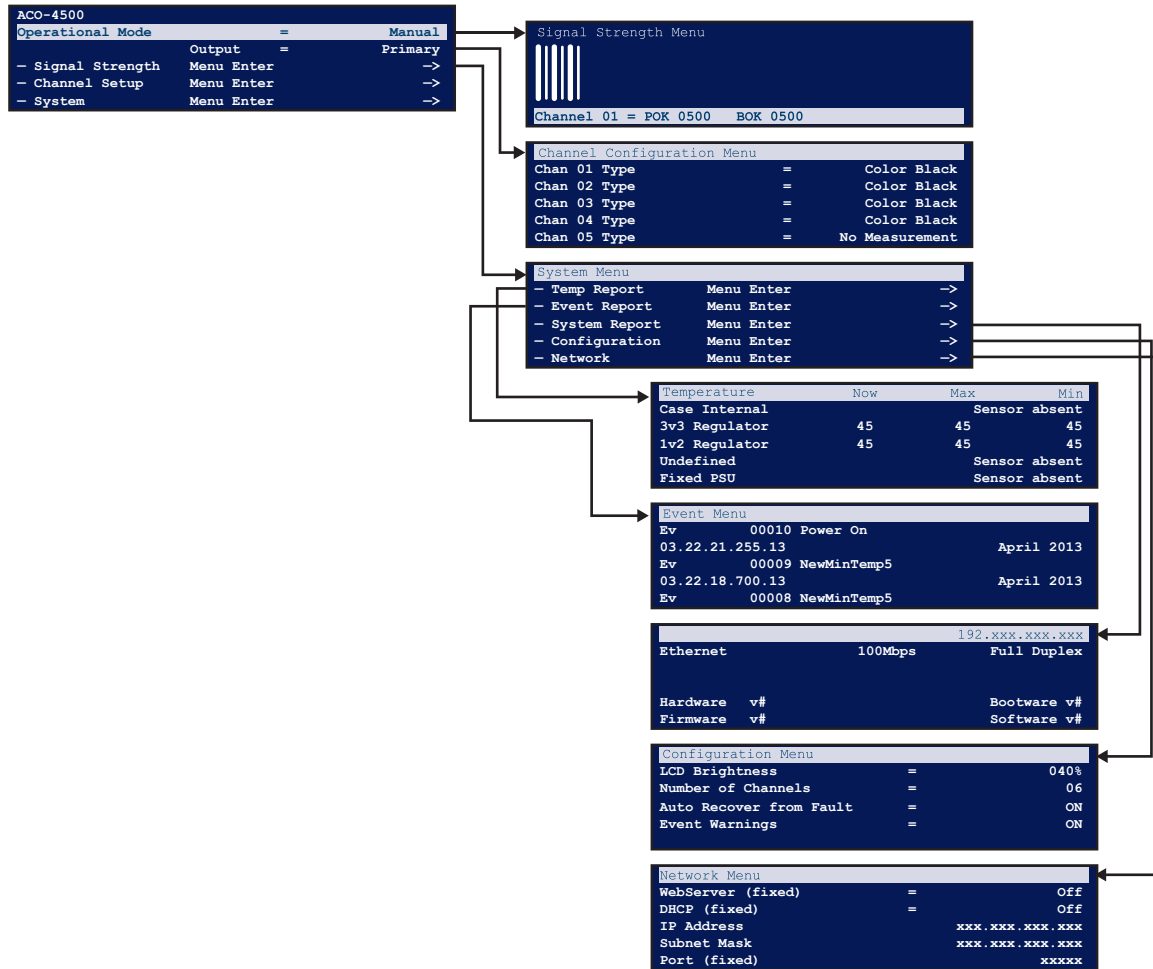

Figure 7.3 ACO-4500 — Menu Map (Pictorial)

Main Menu

Table 7.4 provides an example of the Main Menu. The Main Menu is accessed by either pressing the escape button or the rotary control while viewing the “logo” stand-by screen.

ACO-4500		Faults=nn
Operational Mode	=	Auto
	Output =	Primary
-Signal Strength	Menu Enter	->
-Channel Setup	Menu Enter	->
-System	Menu Enter	->

Figure 7.4 Main Menu Example

Operational Modes

This menu line displays the current mode of operation of the ACO-4500. The options for the field are: Auto, Manual.

Auto

When set to **Auto**, fault detection is enabled, the outputs will automatically default to the Primary inputs, and, when applicable, automatic switching of inputs occurs when a fault is encountered:

Table 7.1 Fault Actions

Fault on	Switch
No fault	Primary
Primary	Backup
Backup	Primary
Primary & Backup	Backup

When a Primary fault is repaired, the output will automatically switch back to the Primary input when the signal is re-connected (provided the signal conforms to that channel's configuration).

Manual

When set to **Manual**, fault detection is “disabled”, and the user is able to manually switch the output to be either the Primary or Backup input, irrespective of any existing faults.

Output

This menu line displays which of the inputs is currently switched to the output. The options for the field are: Primary, Backup. The user can only switch the output to Backup when the “Operational Mode” is set for “Manual”.

Other Menus

The Signal Strength Menu, Channel Setup Menu, and System Setup Menu provide access to further menus or features, all of which are detailed in the following pages.

Signal Strength Menu

Figure 7.5 provides an example of the Signal Strength Menu.

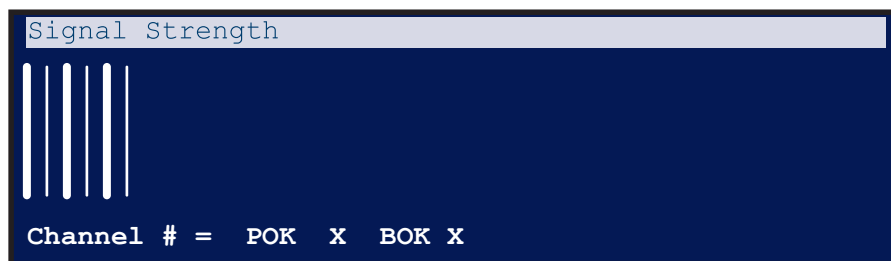

Figure 7.5 Signal Strength Menu Example

The Signal Strength Menu provides a graphical view of the amplitude of all signals connected to the ACO-4500.

The signal bars that appear in the upper section of the display are arranged in the following order (from left to right):

- Channel 1 Primary
- Channel 1 Backup
- Channel 2 Primary
- Channel 2 Backup
- Channel 3 Primary etc.

The maximum number of signal bar pairs displayed will be limited to the “Number of Channels” setting elsewhere in the Menu System.

- If the Channel Type for a particular channel is set for “No Measurement”, then the signal bars will not appear in the relevant position on the display.
- If the input(s) for a particular channel is/are missing, the signal bar(s) for that channel will be displayed at minimum height.
- You may have more channels with signals connected, but these will not be displayed.

The amplitudes of the bars are scaled, so that signals of different nominal amplitudes are all shown with approximately the same height bars on the display. So, for example, if a 600mV TriSync signal is connected to a channel set as Color Black (300mV), the relevant signal bar will be significantly higher than for any other channel with the correct signal present. Similarly, Color Black connected to a TriSync channel will appear significantly lower in amplitude.

The widths of the bars in each channel pair are different - the Primary bar is wider than the Backup bar.

The bottom line of the menu displays the actual detected levels of the Primary and Backup input signals for the currently selected channel.

Channel # = POK X BOK X

The options in the field “#” are: 01 up to the “Number of Channels” setting.

Upon entering this menu, simply rotating the rotary control allows the user to select a channel to display. Press the push-button to return to the Main Menu.

The options displayed in the fields “POK” or “BOK” are:

- PErr / BErr Primary / Backup - Error Detected
- POK / BOK Primary / Backup - No error detected.

The values displayed in the fields “X” represent the actual detected signal levels of the selected input channel.

Channel Configuration Menu

Figure 7.6 provides an example of the Channel Configuration menu.

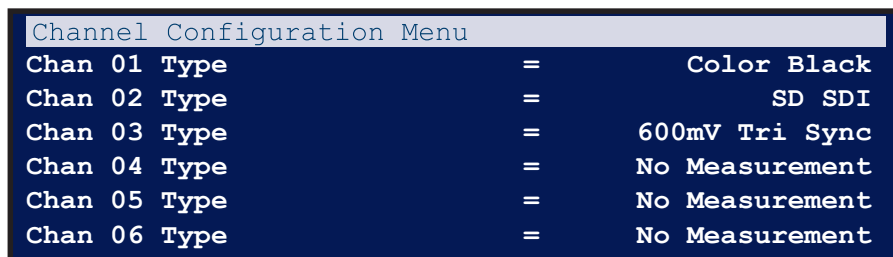

Channel Configuration Menu		
Chan 01	Type	= Color Black
Chan 02	Type	= SD SDI
Chan 03	Type	= 600mV Tri Sync
Chan 04	Type	= No Measurement
Chan 05	Type	= No Measurement
Chan 06	Type	= No Measurement

Figure 7.6 Channel Configuration Menu Example

The Channel Configuration Menu allows the user to configure each BNC channel to monitor the incoming signal according to the selected signal type.

The number of channels displayed in this menu will be the same as that previously set in the menu item: Main Menu | System | Number of Channels. If there are more than 5 active channels, these are accessed by scrolling the menu downwards.

The menu displays the signal type to which each BNC channel is set to monitor. Each setting is selected from the list of supported signal types.

All input signals are detected for amplitude. Some signal types have pre-defined fault levels associated with them, and are used to determine whether an error has occurred. Other signal types have a simpler “Loss Of Signal” detection system. For the special case where signals are present but not required to be monitored for the purpose of errors, the “No Measurement” setting should be used.

Installation Scenarios

The most common scenario is one where a specific number of signals are required to be both monitored and switched. In this case, the “Number of Channels” setting will correspond with the same number of “Channel Configuration Menu” lines, all set to their relevant signal types.

Another scenario is one where more signals are required to be switched than monitored. On the ACO-4500, when a fault occurs, ALL channels switch, regardless of how many inputs are populated or configured. So, for this case, the user can either:

- select the 'additional' channel types as “No Measurement”, or,
- reduce the “Number of Channels” setting to correspond to the actual number of inputs to monitor, rather than the number of inputs connected.

Channel # Type

The options displayed in the field “#” are: 01 up to the “Number of Channels” setting.

Upon entering this menu, rotating the rotary control allows the user to select a channel to adjust. Pressing the rotary control allows the user to adjust the selected channel.

The options for the type are:

- No Measurement
- Color Black (no ancillary signals present, i.e. only Sync & Burst)
- Color Black + VITC (with one or some ancillary signals present)
- 600mV TriSync
- SD SDI - LOS
- HD SDI- LOS
- 3G SDI- LOS
- 1V 10MHz
- 1V Subcarrier
- 1V AES
- 2V Pulses- LOS
- 4V Pulses- LOS

After making your selection, press the rotary control to confirm the selection. Select additional channels to adjust.

When finished, press the push-button to return to the Main Menu.

System Setup Menus

Figure 7.7 provides an example of the System Setup Menu.

System Setup Menu			
- Temp Report	Menu	Enter	->
- Event Report	Menu	Enter	->
- System Report	Menu	Enter	->
- Configuration	Menu	Enter	->
- Network	Menu	Enter	->
- Calibration	Menu	Enter	->

Figure 7.7 System Setup Menu Example

The System Setup menu provides a gateway to the less frequently used options in the ACO-4500.

These options include:

- Extended information in the form of reports, Extended configuration options,
 - Access to factory settings that the user should never have to access or adjust, but may contain useful information to communicate to the factory during a service event.
- ★ Reports contain information only; there are no editable fields in these menus.

Temperature Reports

The Temperature Report appears below (general form).

Temperature	Now	Max	Min
+3v3 Regulator	42	45	41
N+1 Interface			
L PSU turned on		nnnnn	times
L PSU on for		hhhhh.ddd	hours
R PSU turned on		nnnnn	times
R PSU on for		hhhhh.ddd	hours

Figure 7.8 Temperature Reports Menu Example

The Temperature Report provides information on the temperature sensors within the ACO-4500. A typical example might look like: “+3v3 Regulator 42 45 41 “

Depending on the exact configuration and options in the ACO-4500, one or more of the sensors might not be installed. In this case, the description in the relevant line appears as seen in **Figure 7.8**. These menu lines report the power cycle counts and “in service” times for both of the PSUs installed in the N+1 Dual Redundant PSU ACO-4500.

Because the temperature report includes not only the current temperatures and both the minimum and maximum temperatures detected by the installed temperature sensors, but also power supply “in-service” data, this information might be useful if you are experiencing reliability problems in an extreme environment.

Event Report

The Event Report appears below (example form).

Event Menu			
Ev	00010	NewMaxTemp2	
	03.22.21.255.13		12 April 2013
Ev	00009	EthernetLinkMade	
	03.22.18.700.13		12 April 2013
Ev	00008	PowerOn	
	03.22.18.700.13		12 April 2013

Figure 7.9 Event Report Menu Example

The Event Report provides access to the last 99 events recorded by the ACO-4500. These events may relate to normal expected functionality or to systemic errors. This information might be useful in monitoring and diagnosing a system problem outside the ACO-4500, or a reliability problem within the ACO-4500.

```
Ev nnnnn NewMinTempAlarm0
23.59.59.999 01 September 2012
```

This menu row pair provides details of the recorded event.

- The first row provides an event number and the description of the event.
- The second row provides the event time expressed as hours : minutes : seconds : milliseconds, and the event date.

The most recent event is always displayed at the top of the menu. A large number of different events can be recorded.

Table 7.2 Recordable Events

Event	Code	Event	Code
EventDefault	0	EventNewMaxTempAlarm1	27
Event Power On	1	EventNewMaxTempAlarm2	28
EventWatchdogReturn	2	EventNewMaxTempAlarm3	29
EventLVDReturn	3	EventNewMaxTempAlarm4	30
EventPowerOff	4	EventNewMaxTempAlarm5	31
EventLVDEvent	5	EventNewMaxTempAlarm6	32
EventnSetUTCTimeFromGPS	6	EventNewMaxTempAlarm7	33
EventGPSTimeLost	7	EventNewMinTemp0	34
EventSetUTCTimeFromNTP	8	EventNewMinTemp1	35
EventNTPTimeLost	9	EventNewMinTemp2	36
EventLeftPSUfail	10	EventNewMinTemp3	37
EventLeftPSUreturn	11	EventNewMinTemp4	38
EventRightPSUfail	12	EventNewMinTemp5	39
EventRightPSUreturn	13	EventNewMinTemp6	40
EventPSULCDCancelManual	14	EventNewMinTemp7	41
EventPSULCDCancelAuto	15	EventNewMinTempAlarm0	42
EventPSULCDRepeatManual	16	EventNewMinTempAlarm1	43
EventPSULCDRepeatAuto	17	EventNewMinTempAlarm2	44
EventNewMaxTemp0	18	EventNewMinTempAlarm3	45
EventNewMaxTemp1	19	EventNewMinTempAlarm4	46

Table 7.2 Recordable Events

Event	Code	Event	Code
EventNewMaxTemp2	20	EventNewMinTempAlarm5	47
EventNewMaxTemp3	21	EventNewMinTempAlarm6	48
EventNewMaxTemp4	22	EventNewMinTempAlarm7	49
EventNewMaxTemp5	23	EventEthernetLinkMade	50
EventNewMaxTemp6	24	EventEthernetLinkLost	51
EventNewMaxTemp7	25	EventGPSSetTimecodeFromGPSFlag	52
EventNewMaxTempAlarm0	26	EventGPSUnSetTimecodeFromGPSFlag	53

System Report

The System Report appears below.

```

ACO-4500                               192.xxx.xxx.xxx
Frame Serial Number                     =      #####
Module Serial Number                     =      #####
Ethernet                                100Mbps      Full Duplex
ArmFile_0x00200000_v##_###_ata
Bootware v#####                       Software v#####
Hardware v#####                         Firmware v#####
    
```

Figure 7.10 System Report Menu Example

The System Report provides complete version information for the hardware, firmware and software elements that make up the ACO-4500.

ACO-4500 192.xxx.xxx.xxx

This field reports the user programmed Ethernet IP Address of the ACO-4500. The options in the sub-fields appear as: 0 through 255.

Frame Serial Number Field

This field reports the serial number for the ACO-4500.

Module Serial Number Field

This field reports the serial number of the main module installed within the ACO-4500 chassis.

Ethernet Field

This field reports the detailed Ethernet link status. The options in the first sub-field appear as:

- <Blank>
- 10Mbps
- 100Mbps

The options in the second sub-field appear as:

- Full Duplex
- Half Duplex

Additionally, the current Ethernet link status is reported on the bottom line of the Logo screen of the Front Panel Display.

ArmFile Field

The Arm File field reports as ArmFile_0x00200000_vxx_xxx.ata where:

- 0x00200000 represents the load address
- vxx_xxx represents the version number.

Hardware and Firmware Fields

The Hardware field indicates the hardware version in use. This is not usually modified by field upgrades as it relates to the motherboard hardware components in the ACO-4500.

The Firmware field indicates the firmware version in use. This is not usually modified by field upgrades as it relates to the motherboard firmware components in the ACO-4500.

Bootware and Software Fields

The Bootware field indicates the bootware version in use. This is not usually modified by field upgrades as it relates to the motherboard bootware components in the ACO-4500.

The Software field indicates the software version in use. This can be modified in the field when new versions of the software are uploaded via the Ethernet interface.

Configuration Menu

Figure 7.11 provides an example of the Configuration Menu.

```
Configuration Menu
LCD Brightness           =          xx%
LCD Flash on Error      =          xxx
Channels in use         =           nn
Auto Recover from Fault =           ON
Auto recover delay      =        xxxxx secs
Count down              =         xx:xx:xx
Event Warnings          =           ON
```

Figure 7.11 Configuration Menu Example

The Configuration Menu provides access to features that determine the functionality of the ACO-4500 not otherwise covered by other menu settings. These options are typically set up during the system commissioning of the ACO-4500 and thereafter are unlikely to be changed.

LCD Brightness

This menu row allows the user to select the best LCD display parameters for the ambient lighting conditions.

The options are: 0% through 100% in 16 steps.

LCD Flash on Error

This menu line allows the user to select the LCD and Select button to flash when an error is reported. The options are:

- Off — no flash
- On — LCD and Select button flash when errors are reported.

Channels in Use

This menu line allows the user to select the appropriate number of measuring channels that should be enabled for use in the installation.

The minimum allowable number is 1; the maximum number is 12.

Recover from Fault

This menu row allows the user to determine how the ACO-4500 will recover after a fault is rectified. The options are:

- **Never** — never recover
- **Immediate** — recover immediately after the fault is rectified
- **Delayed** — recover after the time specified in the Auto Recover Delay field.

Auto Recover Delay

This menu row allows the user to set the delay time in seconds before an auto recover takes place.

Count Down

This menu row counts down from the timer set in the Auto Recover Delay field to zero (0). The countdown starts when a detected fault is rectified.

Auto Recover from Fault

When set to **ON**, the ACO-4500 will automatically switch back from Backup to Primary upon return of the Primary signal.

When set to **OFF**, the ACO-4500 will need to be manually switched from Backup to Primary after the fault is corrected.

Event Warnings

This menu item allows the user to control the behavior of the LCD when an event occurs. The options are:

- **Off** — no warning messages will pop-up in the LCD.
- **On** — warning messages will pop-up in the LCD.

An event can include:

- loss of ethernet cable connection
- found ethernet cable connection
- the maximum temperature limit was reached

Network Menu

Figure 7.12 provides an example of the Network Menu.

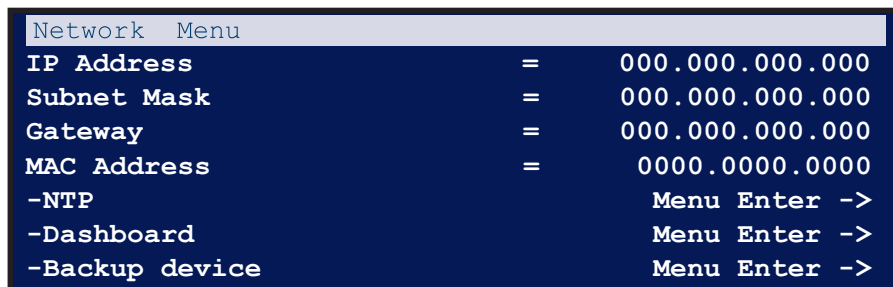

```
Network Menu
IP Address      = 000.000.000.000
Subnet Mask    = 000.000.000.000
Gateway        = 000.000.000.000
MAC Address    = 0000.0000.0000
-NTP           Menu Enter ->
-Dashboard    Menu Enter ->
-Backup device Menu Enter ->
```

Figure 7.12 Network Menu Example

The Network Menu, and the associated sub-menus, allows the user to configure and control the behavior of the Ethernet system within the ACO-4500. Before proceeding, the user must contact their Network Administrator, and obtain suitable IP addresses, etc., that will need to be programmed within this menu.

IP Address

This menu line allows the user to enter the pre-determined IP address of the ACO-4500. The options in the sub-fields are: 000 through 255 where 000" is the default "no action" setting.

To change the settings:

1. pressing the rotary control advances through each sub-field
2. rotating the rotary control changes the value of the currently selected sub-field.

SubNet Mask

This menu line allows the user to enter the pre-determined SubNet Mask address of the ACO-4500.

The options in the sub-fields are: 000 through 255 where "000" is the default "no action" setting.

To change the settings

1. pressing the rotary control advances through each sub-field
2. rotating the rotary control changes the value of the currently selected sub-field.

Gateway

This menu line allows the user to enter the pre-determined Gateway address of the ACO-4500. Typically, this might be the IP address of a network hub to which the ACO-4500 is connected.

The options in the sub-fields are: 000 through 255 where "000" is the default "no action" setting.

To change the settings

1. pressing the rotary control advances through each sub-field
2. rotating the rotary control changes the value of the currently selected sub-field.

MAC Address

This menu line displays the MAC Address (Media Access Control), a unique, read-only identifier assigned to network interfaces for communications on the physical network segment.

This menu item cannot be changed - the MAC address is stored in a hardware device. This address is unique to each ACO-4500, and is also used to provide unique update keys when enabling options within the unit.

NTP, DashBoard, Backup Device

These menu lines provide access to the subsequent menu levels, as indicated. These are defined in the following sections.

DashBoard Menu

Figure 7.13 provides an example of the Dashboard Menu.

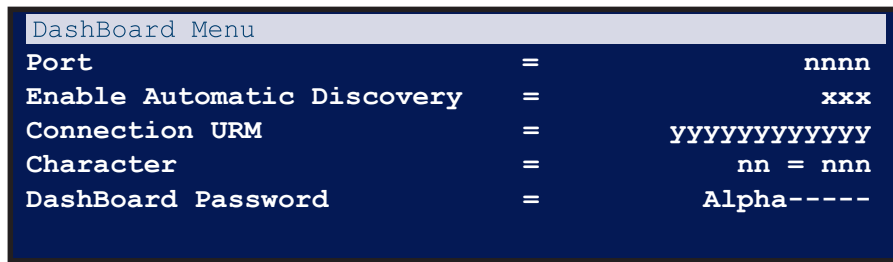

Figure 7.13 DashBoard Menu Example

The DashBoard Menu displays information relating to communications between the ACO-4500 and the external PC-based Remote Control Program.

Port

This menu line allows the user to set the Ethernet Port through which the ACO-4500 communicates with the external PC-based Remote Control Program.

The options in the sub-field are: 5253 (default), and 6666.

Enable Automatic Discovery

This menu line allows the user to select if Dashboard can automatically discover the device.

The options in the sub-field “xxx” are:

- Enable Automatic Discovery = No (default)

Connection URM

This menu line allows to user to control whether the Dashboard User Rights Management (URM) is used.

The options in this menu line appear as:

Connection URM = Unconditional

Character, DashBoard Password

These menu lines only appear when the **Connection URM** is set to **Managed**.

This menu doublet allows the user to select and edit the Dashboard password.

The options in the field “mm” are: 01 through 09.

There are a maximum of 9 characters in the password. “mm” selects which character is ‘active’ and hence editable in the menu.

In the selected DashBoard Password line, as “mm” is changed, a cursor gives a visual indication of which character is active.

The options in the field “yy” are any valid alpha-numeric character from the lists below:

- “Space”
- Numeric: 0123456789
- Uppercase: ABCDEFGHIJKLMNOPQRSTUVWXYZ
- Lowercase: abcdefghijklmnopqrstuvwxyz

The first non-alpha-numeric character terminates the password. The only character available to do this is the space character, which is accessed by rotating the control fully anti-clockwise. The edited password is applied as the menu is exited.

Keep the following in mind:

- After adjusting the field “yyy”, use the Escape/Back button to select the next character to edit, then press Select to edit the next character, etc.
- When using the available front panel controls, editing of the characters in the Dashboard Password is performed in “Overtyping” mode, i.e., it is not possible to “Insert” or “Delete” characters.
- When you edit a pre-programmed Dashboard Password, start from character position 1; do not use spaces between the characters (see above); overtype with spaces (char.#32) any extraneous characters at the end of the password.

Calibration Menu

Figure 7.14 provides an example of the Calibration Menu.

```
Calibration Menu
Changeover Channel      =      nn
Do Calibration?        =      No

P NSig=nnnn Sig=nnnn Fail=nnnn
B NSig=nnnn Sig=nnnn Fail=nnnn
```

Figure 7.14 Calibration Menu Example

Disclaimer

The Calibration Menu contains fundamental settings relating to the functionality and accuracy of the ACO-4500. These settings are determined during initial testing and through subsequent configuration and alignment. They should not normally require re-configuration during service. It is a good idea to make a manual record of these settings in case they become corrupted or are inadvertently changed. A convenient way to achieve this is to print out the table at the end of this section, and record the stored values. You can then store this list in a safe place.

On no account should the user attempt to alter any of these settings without proper authorization from Ross Video Limited.

If problems are encountered, these settings can only be re-instated by performing the detailed Calibration Procedure. Contact Ross Video for further instructions.

Changeover Channel

This menu line allows the user to select the measuring channel to be viewed (or calibrated). The options in the field are: 1 through 12.

Do Calibration?

This menu line enables the user to start the calibration process at the channel number selected in the previous menu line.

The options in the field are:

- No — Calibration Disabled (Default)
- Yes — Calibration Enabled

This menu option is always set to “No” upon entry - it requires a conscious action on the part of the user to set the option to “Yes” and thereby enable calibration value adjustments.

When set to “No”, the user may view the calibration values for any channel at any time.

When set to “Yes”, the user is able to perform the calibration procedure to recalculate the calibration values, starting with the channel number selected above.

To exit from this menu, repeatedly press the [Back] button a sufficient number of times until you reach the “Top Level” menu screen.

P NSig, B NSig

These menu lines display the stored calibration values for the selected channel number. The “P” menu line indicates that the line of calibration values is for the Primary channel.

Similarly, the “B” menu line indicates that the line of calibration values is for the Backup channel.

The “NSig=nnnn” sub-field displays the recorded value for the “no signal present and input terminated” condition.

The “Sig=nnnn” sub-field displays the recorded value for the level of the normal amplitude signal.

The “Fail=nnnn” sub-field displays the recorded value for the level of the reduced amplitude signal that will be used to determine whether the input signal is too low or has failed completely.

Table 7.3 Channel Calibration

Channel	Primary			Backup		
	NSig	Sig	Fail	NSig	Sig	Fail
1						
2						
3						
4						
5						
6						
7						
8						
9						
10						
11						
12						

Troubleshooting

Generally speaking, the ACO-4500 is reliable under normal steady-state operating conditions. If you are having problems, select the symptom from this chapter that closely relates to your particular problem and perform the checks/actions listed.

Notice — Observe all cautions and warnings listed in the document “**Important Regulatory and Safety Notices to Service Personnel**” that accompanied your unit.

Troubleshooting Checklists

In the event of problems with your ACO-4500, the following basic troubleshooting checklist may help identify the source of the problem. If the unit still does not appear to be working properly after checking all possible causes, please contact your Ross Video products distributor, or the Technical Support department at the numbers listed under the section “**Contacting Technical Support**”.

1. **Visual Review** — Performing a quick visual check may reveal many problems, such as connectors not properly seated or loose cables. Check the chassis, and any associated peripheral equipment for signs of trouble.
2. **Power Check** — Check the LCD Display on the front panel for the presence of power. If the display is not illuminated, verify that the power cable is connected to a power source and that power is available at the power main. If the display is still not illuminated, replace the power supply with one that is verified to work.
3. **Input Signal Status** — Verify that source equipment is operating correctly and that a valid signal is being supplied.
4. **Output Signal Path** — Verify that destination equipment is operating correctly and receiving a valid signal.
5. **Unit Exchange** — Exchanging a suspect unit with a unit that is known to be working correctly is an efficient method for localizing problems to individual units.

Table 8.1 provides additional troubleshooting guidance for the ACO-4500.

Table 8.1 Possible Symptoms and Solutions

Symptom	Cause(s)	Action
LCD not operational No changeover action	<ul style="list-style-type: none">• Mains Power Missing• SMPSU fault• Bad power connection(s)	<ul style="list-style-type: none">• Check Mains Power• Check Mains lead integrity• Check rear panel Mains fuse• Check SMPSU fuse
Intermittent Operation	Bad power connection(s)	Check Mains Power connections
Corrupted output(s)	Bad inputs	Check signal sources
“Random” changeover	Calibration value(s) corrupted	Contact Ross Technical Support regarding re-calibration
	Wrong signal type selected	Select Signal type(s) to suit input signals

★ If your problem is not resolved after following these checks/actions, the fault is likely to be related to a mechanical or electrical component failure. Please contact Ross Technical Support for further assistance.

Replacing a Power Supply

Replacing a failed PS-4500 in an ACO-4500 requires the following steps:

1. If applicable, move the handle on the new PS-4500 to the correct side
2. Remove the front faceplate from the main chassis.
3. Remove the failed PS-4500 from the main chassis.
4. Install the new PS-4500 into the main chassis.
5. Re-install the faceplate on the main chassis.

Moving the Handle on the PS-4500

Each new PS-4500 ships with its handle installed on the right. The handle must be installed on the side closest to the rack unit ears to ensure the front faceplate is securely affixed to the main chassis.

- If you are replacing the PS-4500 in the right slot, proceed to “**Removing the Failed PS-4500**”.
- If you are replacing the PS-4500 in the left slot, proceed to “**To move the handle of the PS-4500**”.

To move the handle of the PS-4500

1. Use a Phillips #1 screwdriver to remove the four screws that affix the PSU faceplate to the PS-4500 module.

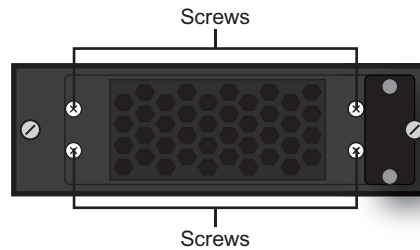

Figure 8.1 Removing the PS-4500 Faceplate Screws

2. Set the screws aside.
3. Remove the PSU faceplate from the PS-4500 module.
4. Rotate the PSU faceplate 180° and position the PSU faceplate so that the:
 - handle is now on the right side of the PS-4500 module and
 - the four screw holes on the PSU faceplate align with the four screw holes on the PS-4500 module.

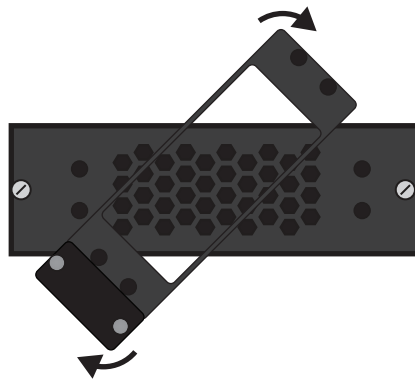

Figure 8.2 Rotating the PS-4500 PSU Faceplate

5. Affix the PSU faceplate to the PS-4500 module using the screws from step 1.

Removing the Front Faceplate

The faceplate is affixed to the main chassis via the rare-earth magnet mounted on the PS-4500 handle closest to the rack unit ears.

To remove the front faceplate from the main chassis

1. Remove the front faceplate by gently pulling it towards you and away from the main chassis.

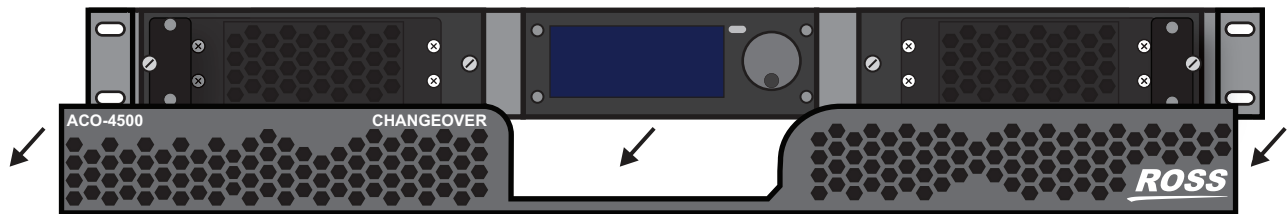

Figure 8.3 Removing the Front Faceplate

2. Set the faceplate aside on a clean, static-free surface.

Removing the Failed PS-4500

A failed PS-4500 can be hot-swapped with a new PS-4500 without powering down the main chassis.

To remove a failed PS-4500

1. Use a 3/16" slotted screwdriver to disengage the captive screws that affix the PS-4500 to the main chassis.
2. Use the handles on the front of the failed PS-4500 to remove the PS-4500 by gently pulling it towards you and away from the chassis.
3. Set the failed PS-4500 aside.

Installing the New PS-4500

The PS-4500 slides into the available slot and connects to the chassis midplane via the blue connector at its rear.

To install a new PS-4500

1. Align the new PS-4500 with its slot in the main chassis.
2. Slide the new PS-4500 into the available slot. You will feel the PS-4500 engage with the midplane.
3. Use a 3/16" slotted screwdriver to tighten the captive screws and affix the PS-4500 to the main chassis.

Re-install the Front Faceplate

You must re-install the front faceplate to the main chassis to complete the install.

To re-install the front faceplate on the main chassis

1. Position the faceplate over the power supplies.
2. Secure the faceplate on the main chassis.

Software Upgrades

This upgrade procedure applies to ACO-4500 systems where an Ethernet connection is installed. It outlines the steps necessary to upgrade the software programmed on the main module.

- ★ Performing a software upgrade to the ACO-4500 requires the unit to be rebooted, and may be off-line for several minutes. Ensure that your system is not in use.

Before You Begin

Before starting, ensure that you comply with the following requirements:

- Connect the ACO-4500 via an Ethernet cable to your local network.
- A PC, also connected via Ethernet to your local network, with the supplied update program(s) and associated data file(s) available. Ideally, data file(s) should be located in the same folder as the associated update program.
- ★ Do not re-name any of the files.
- A power-cycle is required as part of a data file update.
- Ensure that you have the **RossSystemUpdate_Vx.x.x.x.exe** program. Contact Ross Technical Support for this program.
- **Table 8.2** lists the applicable files for your ACO-4500.

Table 8.2 ACO-4500 Files

File Type		Description
Bootware	Bootloader	At present, can only be uploaded at the factory.
ArmFile	ACO-4500 Software	Requires that the ACO-4500 is in Bootloader mode. When complete, a power cycle is required.

Uploading the Software Files

Only newer files need to be loaded. Depending on the situation, an upgrade may consist of one of the following scenarios:

- Full upgrade — Requires the Pattern, FPGA file, and Software files
- Pattern File upgrade — Requires the Pattern files only
- Software upgrade — Requires the Software file only
- Firmware upgrade — Requires the Firmware file only

To prepare for the upgrade

1. Connect the ACO-4500 via an Ethernet cable to your local network.
2. Connect a Windows PC to the network, such that the ACO-4500 is visible.
3. Verify that the Ross System Update Tool and data files are in the same folder on the PC.

To upload software files to the ACO-4500

1. On your PC, launch the “RossSystemUpdate_v#. #. #. # .exe” program.

The **Ross System Update** dialog opens.

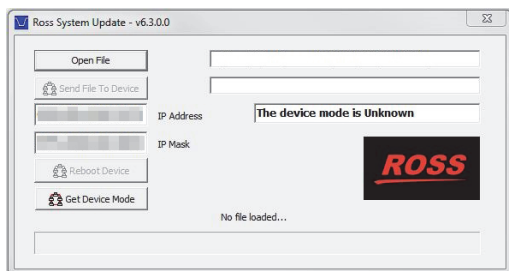

2. Set the IP Address and IP Mask fields to the values for the ACO-4500 you want to upgrade. Note that all octets must be entered as 3-digits. For example, 255.0.0.0 should be entered as 255.000.000.000.
3. Click **Get Device Mode**.
The status field, located above the Ross logo, displays: “The device is in Application mode.”.
4. If the ACO-4500 is “**not found**”:

- a. Check again that all connections have been made.
 - b. Verify that the IP Address and IP Mask values were entered correctly in 2
 - c. Power off the ACO-4500.
 - d. Repeat steps 1 to 3.
5. If the ACO-4500 still cannot be found, contact Ross Video for further assistance.
6. There are 3 files that consist of a full upgrade. Only newer files than those on the unit need be installed. The order they should be installed is as follows:
- a. Pattern File (PatFile_XXXXX.ata)
 - b. FPGA File (XilFile_XXXX.ata)
 - c. Software File (ArmFile_XXXX.ata)
7. For each file:
- a. Click **Open File** to display the **Open File** dialog.
 - b. Select the relevant “*.ata” file.
 - c. Click **OK** to load the file into the Ross System Update Tool and close the **Open File** dialog.
 - d. Click **Send to Device**.
 - e. If this is the first file to be uploaded, you will be asked to confirm the upload.
8. Monitor the upload:
- a. The software will put the ACO-4500 into Bootload mode.
 - b. The Ross System Update Tool erases the old ACO-4500 file.
 - c. The Ross System Update Tool uploads the new file to the ACO-4500.
- ★ Upload of a file takes approximately 1 minute.
- d. The status messages field in the **Ross System Update** dialog confirms that the upload was completed successfully.
 - e. If the upload was not successful, click **Send to Device** again and monitor the process.
9. Once all files have been uploaded successfully, power-cycle the ACO-4500.
10. Verify the software version of the ACO-4500 in DashBoard as follows:
- a. Launch the DashBoard client software on your PC.
 - b. Locate the ACO-4500 in the Basic Tree View in DashBoard.
 - c. Expand the **ACO-4500** main node in the tree view.
 - d. Double-click the **Slot 0: ACO-4500** sub-node.
 - e. Select the **System Report** tab.
 - f. Verify the values in the provided fields match the file(s) you uploaded.
- Your ACO-4500 is now upgraded and ready for use.

Technical Specifications

This chapter provides technical information for ACO-4500.

★ Specifications are subject to change without notice.

General Characteristics

All listed specifications are guaranteed unless labeled with “Typical”. Typical specifications are provided for your convenience, but are not guaranteed.

Performance Conditions

The electrical characteristics listed on the following pages are valid under the following conditions:

- The ACO-4500 must be in an environment where the temperature, altitude, humidity, and vibration conditions are within the operating limits described in the section “**Environment Characteristics**” on page 57.
- The ACO-4500 must have a warm-up period of at least 20 minutes.
- The ACO-4500 must have been calibrated and adjusted at an ambient temperature between +20°C and +30°C at an altitude of less than 2000m.

BNC Channels

Table 9.1 Technical Specifications — BNC Channels

Category	Performance Requirement	Notes
Input Connector Type	3 x 75ohm BNC per channel	The non-selected input is automatically terminated
Return Loss (all inputs and outputs)	270Mbps: <-11dB	
	1.5Gbps: <-4dB	
	3Gbps: <-1.4dB	
Typical Amplitude	270Mbps: 800mV +/- 10%	
	1.5Gbps: 780mV +/- 10%	
	3Gbps: 660mV +/- 10%	
Typical Rise & Fall Time	270Mbps: 600ps/595ps +/- 10%	
	1.5Gbps: 155ps/145ps +/- 10%	
	3Gbps: 135ps/130ps +/- 10%	
Maximum Switched Voltage	30V DC (30V AC)	
Maximum Switched Current	0.5A	
Relay Switch Time	Based on Relay characteristics: <ul style="list-style-type: none">• Set time: typ. 3.5 ms,• Release time: typ. 2.5 ms,• Set/Release: max. 10mS	
Insertion Delay	<1ns	

Balanced (Unmonitored Channels, Relay Changeover)

Table 9.2 Technical Specifications — Balanced (Unmonitored Channels)

Category	Performance Requirement	Notes
Connector Type	Molex® MicroClasp™ 2mm, 30-pin	
Maximum Switched Voltage	48 V DC (24 V AC)	
Maximum Switched Current	1 A	
Relay Switch Time	Based on Relay characteristics: Set time: max. 3 ms, Release time: max. 2 ms, Set/Release: min. 9mS.	
Insertion Delay	<1ns	

RS-232 Port

★ This port is not implemented.

Table 9.3 Technical Specifications — RS-232

Category	Performance Requirement	Notes
Connector Type	Molex® MicroClasp™ 2mm, 30-pin	
Outputs	Pin 2: GND	
	Pin 4: RS232 TX	
Inputs	Pin 3: RS232 RX	

Ethernet Interface

Table 9.4 Technical Specifications — Ethernet

Category	Performance Requirement	Notes
Connector Type	1 x RJ45 - 8P8C	
IEEE Standards Compliance	IEEE 802.31-1990	10BASE-T
	IEEE 802.3u-1995	100BASE-TX

AC Power Source

Table 9.5 Technical Specifications — AC Power Source

Category	Performance Requirement	Notes
Operational Voltage Range	120-230VAC, 50-60Hz	
Absolute Limits Voltage Range	90-264VAC, 47-63Hz	

Table 9.5 Technical Specifications — AC Power Source

Category	Performance Requirement	Notes
Fuse	5mmx20mm, Anti-surge 2A 250V, Fuse identification marking T2A H250V	IEC 60127-2
Operational AC Current	<130mA @ 230VAC	
	<200mA @ 120VAC ^a	
Surge AC Current	<40A @ 230VAC ^a	
	<20A @ 120VAC ^a	
Power Consumption	46VA	~21W - calculated

a. Each PSU.

Clearance Requirements

Table 9.6 Technical Specifications — Clearance

Category	Performance Requirement	Notes
Clearance	Side	50mm (2.00")
	Rear	75mm (3.00")

Mechanical Characteristics

Table 9.7 Technical Specifications — Mechanical

Category	Performance Requirement	Notes
Dimensions	Height	43.5mm (1.71")
	Width	482.5mm (19.00")
	Depth	405mm (15.96")
	Net Weight	5.85kg (12.9lb)

Environment Characteristics

Table 9.8 Technical Specifications — Environment

Category	Performance Requirement	Notes
Temperature	Operating	0°C to +40°C
	Non-operating	-20°C to +60°C
Relative Humidity (non-condensing)	Operating	20% to 80% relative humidity (%RH) at up to +40°C
	Non-operating	5% to 90% relative humidity (%RH) at up to +60°C
Altitude	Operating	To 2,000m (6,561ft)
	Non-operating	To 12,192m (40,000ft)

Table 9.8 Technical Specifications — Environment

Category		Performance Requirement
Vibration	Operating	2.65m/s ² (0.27Grms), 5Hz to 500Hz 10 minutes per axis, three axes
	Non-operating	22.3m/s ² (2.28Grms), 5Hz to 500Hz 10 minutes per axes, three axes
Shock	Non-operating	294m/s ² (30G), half-sine, 11ms duration

Connector Pinouts

This chapter lists the pinouts of various multi-way connectors available on the ACO-4500. Specifications are subject to change without notice.

Balanced Signal Connectors

Table 10.1 applies to the three 30-pin, Molex® 2mm micro-clasp connector located on the ACO-4500 rear panel.

Table 10.1 Balanced Pinouts

Pin	Signal/Function	
1	Ground	
2	Ground	
3	+	LTC1-4/AES1-8/DARS/2.0484MHz
4	-	
5	+	LTC1-4/AES1-8/DARS/2.0484MHz
6	-	
7	+	LTC1-4/AES1-8/DARS/2.0484MHz
8	-	
9	+	LTC1-4/AES1-8/DARS/2.0484MHz
10	-	
11	+	LTC1-4/AES1-8/DARS/2.0484MHz
12	-	
13	+	LTC1-4/AES1-8/DARS/2.0484MHz
14	-	
15	+	LTC1-4/AES1-8/DARS/2.0484MHz
16	-	
17	+	LTC1-4/AES1-8/DARS/2.0484MHz
18	-	
19	+	AES2
20	-	
21	+	AES1
22	-	
23	+	DARS
24	-	
25	+	AUD1 Left
26	-	
27	+	AUD2 Right
28	-	
29	Ground	
30	Ground	

Pin Views of Connectors

Connectors are Molex™ Micro Clasp 2mm series.

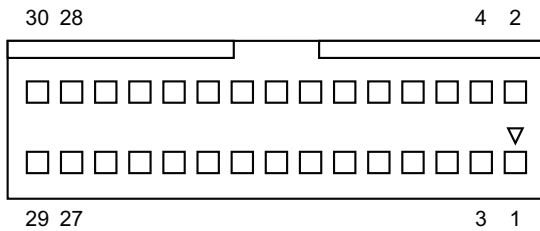

Figure 10.1 Chassis Connectors (Molex #55959-3030)

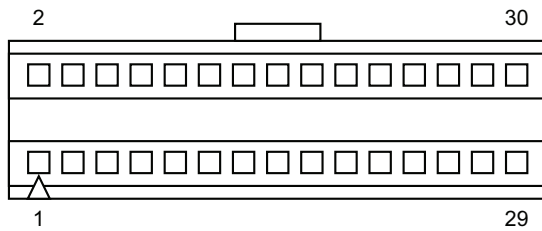

Figure 10.2 Mating Connectors (Molex #51353-3000)

RS232 Connector

★ This port is not implemented.

Table 10.2 provides the pinouts (Molex® 2mm MicroClasp™ series plug (male)) for the RS232 connector.

For More Information on...

- these ports, refer to the chapter “Technical Specifications” on page 55.

Table 10.2 GPI/RS232 Connector

Pin	Signal/Function
1	Ground
2	Ground
3	RS232 - RX
4	RS232 - TX
5	GP Input 1 - TTL compatible
6	GP Input 2 - TTL compatible
7	GP Output 1 - Open Collector
8	GP Output 2 - Open Collector
9	ONAIR - Open Collector
10	Ground

Breakout Cable

Table 10.3 provides the pinouts for the RS232 breakout cable and can be used for the following connector types:

- 10-pin connector Molex® 2mm MicroClasp™ series socket (female)
- 9-pin connector, D-type, plug (male)

Table 10.3 RS232 Breakout Cable

10-Pin Micro-clasp	Signal/Function	D9 Plug (Male)
1	Ground	n/c
2	Ground	5
3	RS232 - RX	2

Table 10.3 RS232 Breakout Cable

10-Pin Micro-clasp	Signal/Function	D9 Plug (Male)
4	RS232 - TX	3
5	GP Input 1 - TTL compatible	n/c
6	GP Input 2 - TTL compatible	n/c
7	GP Output 1 - Open Collector	n/c
8	GP Output 2 - Open Collector	n/c
9	ONAIR - Open Collector	9
10	Ground	

Pin Views of Chassis Connectors

Connectors are Molex™ Micro Clasp 2mm series.

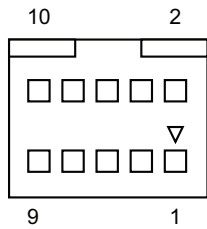

Figure 10.3 Chassis Connectors (Molex #55959-1030)

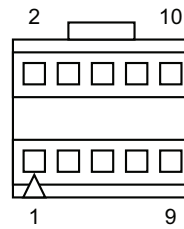

Figure 10.4 Mating Connectors (Molex #51353-1000)

Calibration Procedure

The Calibration Menu contains fundamental settings relating to the functionality and accuracy of the ACO-4500. These settings are programmed during initial testing and through subsequent configuration and alignment. It is a good idea to make a manual record of these settings in case they become corrupted or are inadvertently changed. A convenient way to achieve this is to print out the table at the end of the System Setup Menu section, and record the stored values. You can then store this list in a safe place.

Disclaimer

Most of these settings are determined during initial testing and through subsequent configuration and alignment. They should not normally require re-configuration during service. In some cases, specific test equipment or even custom apparatus is required to perform calibration and configuration.

On no account should the user attempt to alter any of these settings without proper authorization from Ross Video Limited.

If problems are encountered, these settings can only be re-instated by performing the detailed Calibration Procedure that follows.

Contact Ross Video for further instructions.

Calibrating the ACO-4500

The ACO-4500 Calibration Procedure should ideally be performed on a test bench. Easy access to the rear panel BNCs is required.

The following specific equipment is required to perform this procedure:

- At least 2 x 75ohm BNC terminations (certified)
- At least 2 x 50ohm BNC terminations (certified)
- At least 2 x 75ohm BNC T-piece adapters
- SRG-4500 producing at least 2 outputs of analog Color Black (without VITS, VITC or any other ancillary signals)
- Several short BNC cables
- Configure the ACO-4500 for Operating Mode = “Manual”, and Output = “Primary”

★ Familiarity with menu navigation will be assumed - specific menu selection instructions may be shortened for clarity.

To calibrate the ACO-4500

1. Navigate to the Calibration Menu.
 - a. Select the channel to be adjusted.
 - b. Select “Do Calibration” = “Yes”.
2. Verify that the Menu reads: “Terminate the output”.
3. Connect a T-piece with a 75ohm termination onto the output BNC of the channel to be adjusted.
4. Press the rotary control. The Menu reads: “**Taking no signal val.**”.
5. Press the rotary control. The Menu reads: “**Apply signals**”.
6. Connect 2 x Color Black to the Primary and Backup inputs of the channel being adjusted.
7. Press the rotary control. The Menu reads: “**Taking signal values**”.

8. Press the rotary control. The Menu reads: “**Add 50ohm term**”.
 9. Add a 50ohm termination onto the T-piece already on the output BNC of the channel being adjusted.
 10. Press the rotary control. The Menu reads: “**Take fail values**”.
 11. Press the rotary control. The Menu shows that the next channel is ready to be calibrated.
 12. If you wish to continue, repeat from step 2. for the next channel. Use either the same T-piece or a second one for applying the terminations.
 13. If you do not wish to continue, use the back button to return to the Main Menu.
 14. You must exit fully from the Menu system in order to permanently save the new calibration values.
 15. If you had previously recorded the calibration values when you received the unit, the values stored after this calibration session should correspond quite closely with those original ones.
- ★ In the event of a procedural error, simply use the back button to return to the start of the current channel calibration.

Service Information

This chapter contains procedures for cleaning and performing preventive maintenance on the ACO-4500, general servicing information, and the warranty policies.

User Maintenance

This section contains information for cleaning and performing preventive maintenance on the ACO-4500.

General Care

Protect the instrument from adverse conditions, i.e. high humidity, high temperatures, etc. The instrument is NOT waterproof.

When handling the unit or any of its controls, do so with clean hands.

Do not use excessive force to operate any of the controls on the unit.

Exterior Cleaning

Clean the instrument periodically to prevent the accumulation of dust or dirt. Accumulated dust in the instrument acts like an insulating blanket, preventing proper cooling, resulting in overheating and ultimately premature component breakdown. Under high humidity conditions, accumulated dust can also result in an electrically conductive path.



Warning — *To avoid personal injury, always remove the power cord before cleaning the instrument.*

A vacuum cleaner may be used to remove accumulated dust on the outside of the instrument. Ensure that the nozzle is fitted with a soft brush head (or similar) to avoid damaging the instrument.



Caution — *Avoid exposing the instrument to liquids, sprays or solvents, as this could damage the unit. Cleaning agents may also damage the instrument. Avoid solutions that contain harmful chemicals such as Acetone, Benzene, Toluene, Xylene, or similar.*

If the exterior surfaces or controls of the instrument require further cleaning, use a dry, lint-free cloth or a soft-bristle brush. If dirt remains, use a cloth or swab dampened with a 75% isopropyl alcohol solution. A swab is useful for cleaning in narrow spaces around the controls and connectors. Do not use excessive amounts of the approved cleaning solution when cleaning the instrument. Do not use abrasive compounds on any part of the instrument.



Caution — *Do not allow moisture or dust to enter the instrument during exterior cleaning. Only use enough solution to mildly dampen a cloth or similar. After cleaning, use de-ionized water on a clean cloth to “rinse” the instrument.*

Preventive Maintenance

Preventive Maintenance mainly consists of periodic cleaning. Periodic cleaning reduces instrument breakdown and increases reliability. Clean the instrument whenever needed (using the guidelines outlined above), based on the operating environment. Dirty conditions may require more frequent cleaning than a conventional “clean room” environment.

Servicing

The ACO-4500 should require little or no in-service maintenance to the installed electronics. Provided the measures outlined in the section “**Preventive Maintenance**” on page 65 are adhered to, the product should perform for several years without any major user intervention.

Maintenance of components within the product is not usually required, except under exceptional circumstances. If a fault occurs, please follow the instructions listed in the chapter “**Troubleshooting**” on page 49 before attempting to service the product. The servicing of any of the internal components requires the unit to be extracted from the bay and the top cover removed. If your problem cannot be resolved, contact Ross Video for further advice.

If you ordered a Service Option, then removing the unit from the bay and returning it to Ross Video for updating will provide the user with the opportunity to inspect the unit for any problems relating to the operating conditions/environment.

Service Safety Overview

Only qualified personnel should perform service procedures. Read this section before performing any service procedures.

- **Do Not Service Alone.** Do not perform internal service or adjustments of this product unless another person capable of rendering first aid and resuscitation is present.
- **Disconnect Power.** To avoid electric shock, switch off the power to the instrument, then disconnect the power cord from the mains power.
- **Use Care When Servicing With Power On.** Dangerous voltages or currents may exist in this product. Disconnect power, remove battery (if applicable), and disconnect test leads before removing protective panels, soldering, or replacing components.
- **Observe Static Precautions.** Servicing of this product should be performed only in a static-safe environment, i.e. at a suitably configured ESD Workstation. Always use a Static Grounding Wrist-Strap connected to the ESD Workstation mat while servicing the product.
- To avoid electric shock, do not touch exposed connections.

Important Information Regarding the use of Switch Cleaners

Switch Cleaner products usually contain a lubricating additive (along with the “alcohol- based” propellant), intended to remain after spraying into relevant components.

Some equipment produced by Ross Video contains components that should not be cleaned using these types of cleaners, due to the compact nature of the components, their operating characteristics, or their inaccessibility. This is because push-buttons, for example, rely on clean, dry, conductive contact surfaces to operate correctly. Applying Switch Cleaner lubricant only serves to attract dust, or worse still could “wash-in” grease and dust, which could severely reduce the conductivity of the component parts.

Therefore, Ross Video does not recommend the use of these Switch Cleaner products on their equipment, and will not be held liable for any fault caused by inadvertent or unqualified use or application of such products.

Warranty and Repair Policy

The ACO-4500 is warranted to be free of any defect with respect to performance, quality, reliability, and workmanship for a period of ONE (1) year from the date of shipment from our factory. In the event that your ACO-4500 proves to be defective in any way during this warranty period, Ross Video Limited reserves the right to repair or replace this piece of equipment with a unit of equal or superior performance characteristics.

Should you find that this ACO-4500 has failed after your warranty period has expired, we will repair your defective product should suitable replacement components be available. You, the owner, will bear any labor and/or part costs incurred in the repair or refurbishment of said equipment beyond the ONE (1) year warranty period.

In no event shall Ross Video Limited be liable for direct, indirect, special, incidental, or consequential damages (including loss of profits) incurred by the use of this product. Implied warranties are expressly limited to the duration of this warranty.

This ACO-4500 User Manual provides all pertinent information for the safe installation and operation of your Ross Video Product. Ross Video policy dictates that all repairs to the ACO-4500 are to be conducted only by an authorized Ross Video Limited factory representative. Therefore, any unauthorized attempt to repair this product,

by anyone other than an authorized Ross Video Limited factory representative, will automatically void the warranty. Please contact Ross Video Technical Support for more information.

In Case of Problems

Should any problem arise with your ACO-4500, contact the Ross Video Technical Support Department using the information provided in the section “**Contacting Technical Support**” on page 12.

A Return Material Authorization number (RMA) will be issued to you, as well as specific shipping instructions, should you wish our factory to repair your ACO-4500. If required, a temporary replacement frame will be made available at a nominal charge. Any shipping costs incurred will be the responsibility of you, the customer. All products shipped to you from Ross Video Limited will be shipped collect.

The Ross Video Technical Support Department will continue to provide advice on any product manufactured by Ross Video Limited, beyond the warranty period without charge, for the life of the equipment.

Glossary

The following terms are used throughout this guide:

- “**Almanac**” refers to a set of parameters included in the GPS satellite navigation message that a receiver uses to predict the approximate location of a satellite. The almanac contains information about all of the satellites in the constellation.
- “**CW signals**” refers to continuous wave signals.
- “**Ephemeris**” is a description of the path of a celestial body indexed by time. The navigation message from each GPS satellite includes a predicted ephemeris for the orbit of that satellite valid for the current hour. The ephemeris is repeated every 30 seconds and is in the form of a set of 16 Keplerian-like parameters with corrections that account for the perturbations to the orbit caused by the earth’s gravitational field and other forces.
- “**Epoch**” is an instant of time (or a date) from which values of data are referenced. Note: an Era is the period of time between successive epochs.
- “**GLONASS**” refers to the Global Navigation Satellite System.
- “**GPS**” refers to global positioning system.
- “**Operator**” and “**User**” refer to the person who uses ACO-4500.
- “**RF interference**” refers to radio frequency interference
- “**System**” and “**Video system**” refer to the mix of interconnected production and terminal equipment in your environment.
- “**UTC**” refers to Co-ordinated Universal Time. The time scale based on the atomic second but occasionally corrected, by the insertion of leap seconds, to keep it approximately synchronized with Earth’s rotation. The leap second adjustments keep UTC within 0.9 seconds UT1.

