



---

## MC1-UHD User Guide

# Thank You for Choosing Ross

You've made a great choice. We expect you will be very happy with your purchase of Ross Technology.

Our mission is to:

1. Provide a Superior Customer Experience
  - offer the best product quality and support
2. Make Cool Practical Technology
  - develop great products that customers love

Ross has become well known for the Ross Video Code of Ethics. It guides our interactions and empowers our employees. I hope you enjoy reading it below.

If anything at all with your Ross experience does not live up to your expectations be sure to reach out to us at [solutions@rossvideo.com](mailto:solutions@rossvideo.com).



David Ross  
CEO, Ross Video  
[dross@rossvideo.com](mailto:dross@rossvideo.com)

## Ross Video Code of Ethics

Any company is the sum total of the people that make things happen. At Ross, our employees are a special group. Our employees truly care about doing a great job and delivering a high quality customer experience every day. This code of ethics hangs on the wall of all Ross Video locations to guide our behavior:

1. We will always act in our customers' best interest.
2. We will do our best to understand our customers' requirements.
3. We will not ship crap.
4. We will be great to work with.
5. We will do something extra for our customers, as an apology, when something big goes wrong and it's our fault.
6. We will keep our promises.
7. We will treat the competition with respect.
8. We will cooperate with and help other friendly companies.
9. We will go above and beyond in times of crisis. *If there's no one to authorize the required action in times of company or customer crisis - do what you know in your heart is right. (You may rent helicopters if necessary.)*

# MC1-UHD · User Guide

- Ross Part Number: **8922DR-304-07**
- Release Date: August 14, 2023.
- Software Version: 2.4

The information contained in this Guide is subject to change without notice or obligation.

## Copyright

©2023 Ross Video Limited, Ross®, and any related marks are trademarks or registered trademarks of Ross Video Limited. All other trademarks are the property of their respective companies. PATENTS ISSUED and PENDING. All rights reserved. No part of this publication may be reproduced, stored in a retrieval system, or transmitted in any form or by any means, mechanical, photocopying, recording or otherwise, without the prior written permission of Ross Video. While every precaution has been taken in the preparation of this document, Ross Video assumes no responsibility for errors or omissions. Neither is any liability assumed for damages resulting from the use of the information contained herein.

## Patents

Patent numbers US 7,034,886; US 7,508,455; US 7,602,446; US 7,802,802 B2; US 7,834,886; US 7,914,332; US 8,307,284; US 8,407,374 B2; US 8,499,019 B2; US 8,519,949 B2; US 8,743,292 B2; GB 2,419,119 B; GB 2,447,380 B; and other patents pending.

## Notice

The material in this manual is furnished for informational use only. It is subject to change without notice and should not be construed as commitment by Ross Video Limited. Ross Video Limited assumes no responsibility or liability for errors or inaccuracies that may appear in this manual.

## Safety Notices

Refer to the “**Important Regulatory and Safety Notices**” document that accompanied your product.

## Statement of Compliance

This product has been determined to be compliant with the applicable standards, regulations, and directives for the countries where the product is marketed.

Compliance documentation, such as certification or Declaration of Compliance for the product is available upon request by contacting [techsupport@rossvideo.com](mailto:techsupport@rossvideo.com). Please include the product; model number identifiers and serial number and country that compliance information is needed in request.

## EMC Notices

### US FCC Part 15

This equipment has been tested and found to comply with the limits for a class A Digital device, pursuant to part 15 of the FCC Rules.

---

These limits are designed to provide reasonable protection against harmful interference when the equipment is operated in a Commercial environment. This equipment generates, uses, and can radiate radio frequency energy and, if not installed and used in accordance with the instruction manual, may cause harmful interference to radio communications. Operation of this equipment in a residential area is likely to cause harmful interference in which case the user will be required to correct the interference at his own expense.



**Notice** — *Changes or modifications to this equipment not expressly approved by Ross Video Ltd. could void the user's authority to operate this equipment.*

#### Canada

This Class "A" digital apparatus complies with Canadian ICES-003 and part 15 of the FCC Rules.  
Cet appareil numerique de la classe "A" est conforme a la norme NMB-003 du Canada.

#### European Union

This equipment is in compliance with the essential requirements and other relevant provisions established under regulation (EC) No 765/2008 and Decision No 768/2008/EC referred to as the "New Legislative Framework".



**Warning** — *This equipment is compliant with Class A of CISPR 32. In a residential environment this equipment may cause radio interference.*

#### Australia/New Zealand

This equipment is in compliance with the provisions established under the Radiocommunications Act 1992 and Radiocommunications Labeling (Electromagnetic Compatibility) Notice 2008.

#### Korea

This equipment is in compliance with the provisions established under the Radio Waves Act.

Class A equipment (Broadcasting and communications service for business use)

This device is a business-use (Class A) EMC-compliant device. The seller and user are advised to be aware of this fact. This device is intended for use in areas outside home.

Type of Equipment	User's Guide
A급 기기 (업무용 방송통신기자재)	이 기기는 업무용(A급) 전자파적합기기로서 판매자 또는 사용자는 이 점을 주의하시기 바라며, 가정외의 지역에서 사용하는 것을 목적으로 합니다.
Class A Equipment (Industrial Broadcasting & Communication Equipment)	This equipment is <b>Industrial (Class A) electromagnetic wave suitability equipment</b> and seller or user should take notice of it, and this equipment is to be used in the places except for home.

#### International

This equipment has been tested under the requirements of CISPR 22:2008 or CISPR 32:2015 and found to comply with the limits for a Class A Digital device.



**Notice** — *This is a Class A product. In domestic environments, this product may cause radio interference, in which case the user may have to take adequate measures.*

## Maintenance/User Serviceable Parts

Routine maintenance to this openGear product is not required. This product contains no user serviceable parts. If the module does not appear to be working properly, please contact Technical Support using the numbers listed under the “**Contact Us**” section of this manual. All openGear products are covered by a generous 5-year warranty and will be repaired without charge for materials or labor within this period. See the “**Warranty and Repair Policy**” section in this manual for details.

## Environmental Information

The equipment may contain hazardous substances that could impact health and the environment.

To avoid the potential release of those substances into the environment and to diminish the need for the extraction of natural resources, Ross Video encourages you to use the appropriate take-back systems. These systems will reuse or recycle most of the materials from your end-of-life equipment in an environmentally friendly and health conscious manner.

The crossed-out wheeled bin symbol invites you to use these systems.



If you need more information on the collection, reuse, and recycling systems, please contact your local or regional waste administration. You can also contact Ross Video for more information on the environmental performances of our products.

## Security and Privacy

If you would like more information on how Ross Video security and privacy practices have been applied to the MC1-UHD, what you should know about maintaining security of this product, and how we can partner with you to ensure security throughout this product's life-cycle, contact [techsupport@rossvideo.com](mailto:techsupport@rossvideo.com).

Ross Video has implemented reasonable administrative, technical, and physical safeguards to help protect against security incidents and privacy breaches involving a Ross Video product provided those products are used in accordance with Ross Video instructions for use. However, as systems and threats evolve, no system can be protected against all vulnerabilities and we consider our customers the most important partner in maintaining security and privacy safeguards. If you have any concerns, we ask that you bring them to our attention, and we will investigate. Where appropriate, we will address the issue with product changes, technical bulletins and/or responsible disclosures to customers and regulators. Ross Video continuously strives to improve security and privacy throughout the product life-cycle using practices such as:

- Privacy and Security by Design
  - Product and Supplier Risk Assessment
  - Vulnerability and Patch Management
  - Secure Coding Practices and Analysis
  - Vulnerability Scanning
  - Access Controls appropriate to Customer Data
  - Incident Response
  - Clear paths for two-way communication between customers and Ross Video
-

If you would like to report a potential product related privacy or security issue (incident, breach, or vulnerability), contact [techsupport@rossvideo.com](mailto:techsupport@rossvideo.com).

## Company Address



### **Ross Video Limited**

8 John Street  
Iroquois, Ontario  
Canada, K0E 1K0

### **Ross Video Incorporated**

P.O. Box 880  
Ogdensburg, New York  
USA 13669-0880

---

General Business Office: (+1) 613 • 652 • 4886

Fax: (+1) 613 • 652 • 4425

Technical Support: (+1) 613 • 652 • 4886

After Hours Emergency: (+1) 613 • 349 • 0006

E-mail (Technical Support): [techsupport@rossvideo.com](mailto:techsupport@rossvideo.com)

E-mail (General Information): [solutions@rossvideo.com](mailto:solutions@rossvideo.com)

Website: <http://www.rossvideo.com>

---

# Contents

<b>Introduction</b>	<b>13</b>
Related Publications .....	14
Documentation Conventions .....	14
Interface Elements .....	14
User Entered Text .....	14
Referenced Guides .....	14
Menu Sequences .....	14
Important Instructions .....	15
Contacting Technical Support .....	15
<b>Before You Begin</b>	<b>17</b>
Overview .....	17
Features .....	17
Functional Block Diagram .....	18
User Interfaces .....	19
DashBoard Interfaces .....	19
Third-Party Protocols .....	19
MC1-PANEL-16 .....	19
<b>Integration Example</b>	<b>21</b>
System Integration Example .....	21
Physical Setup Overview .....	22
Network Settings Overview .....	22
Configure the MC1-UHD .....	22
XPression Setup Requirements .....	22
<b>Hardware Overview</b>	<b>23</b>
Overview .....	23
Main PCB Overview .....	23
Reset Button .....	23
Reference Termination Jumper (J3) .....	23
Back Components (Not Shown) .....	24
Audio Daughter Card .....	24
MC1-UHD Cabling Overview .....	24
MC1-UHD-A Cabling Overview .....	25
MC1-UHD-B Cabling Overview .....	25
<b>Physical Installation</b>	<b>27</b>
Before You Begin .....	27
Removing the Blank Plates from the Rear Panel .....	27
Installing the Rear Module into the OGX-FR Frame .....	28
Installing the MC1-UHD into an OGX-FR Frame .....	28
<b>Cabling</b>	<b>31</b>
Cabling the Ethernet Port on the OGX-FR Frame .....	31
Cabling for the MC1-UHD Local Reference Input .....	31
Video Signal Cabling .....	32
SDI Inputs .....	32
SDI Outputs .....	32
Serial Cabling .....	33

GPI/Tally Cabling .....	34
Audio Cabling .....	35
<b>Getting Started</b>	<b>37</b>
Before You Begin .....	37
Launching DashBoard .....	37
Configuring the Initial Network Settings .....	37
Accessing the MC1-UHD Interfaces in DashBoard .....	38
Configuring the Remote Logging Feature .....	40
Security Configuration .....	41
<b>Licensed Features</b>	<b>43</b>
License Keys Overview .....	43
Installing a License Key .....	43
Removing a License Key .....	43
<b>Reference and Video Format Setup</b>	<b>45</b>
Specifying a Global Reference Source .....	45
Frame Rate Compatibility .....	45
Monitoring the Reference Signal via DashBoard .....	46
Specifying the Video Format .....	46
Configuring the Time Source .....	47
<b>Configuring the Outputs</b>	<b>49</b>
Before You Begin .....	49
Specifying the Outputs .....	49
<b>Router Setup</b>	<b>51</b>
Ultrix Setup Overview .....	51
Communications Setup .....	52
Third-Party Router Setup .....	53
Specifying the Router Switch Retries .....	54
Assigning a Router Output to an SDI Input on the MC1-UHD .....	54
Using Parked Sources .....	54
<b>Crosspoint Mapping</b>	<b>55</b>
Default Crosspoint Mapping .....	55
Specifying the Number of Available Crosspoints .....	55
Mapping the Program and Preset Crosspoints .....	56
<b>Using RossTalk</b>	<b>59</b>
Using an Ethernet Connection .....	59
Cabling Requirements .....	59
Configuring the MC1-UHD for RossTalk Communications .....	59
Using a Serial Connection .....	59
Cabling Requirements .....	60
Configuring the MC1-UHD for Serial RossTalk Communications .....	60
Using the RossTalk Protocol .....	60
Sending RossTalk Commands .....	60
Supported RossTalk Commands .....	61
<b>Control® DeviceMaster® Setup</b>	<b>63</b>
Cabling Requirements .....	63



DeviceMaster Setup .....	63
MC1-UHD Setup .....	64
<b>Using TSL UMD v3.1 Protocol</b> .....	<b>65</b>
Using a Serial Connection .....	65
Configuring the MC1-UHD for Serial TSL UMD Communications .....	65
Using an Ethernet Connection .....	66
Cabling Requirements .....	66
Configuring the MC1-UHD for Ethernet TSL UMD Communications .....	66
Tally Label Settings .....	66
Protocol Implementation .....	66
<b>Using the Presmaster Protocol</b> .....	<b>69</b>
Configuring an Ethernet Connection for Presmaster .....	69
Configuring the MC1-UHD for Ethernet Presmaster Communications .....	69
Configuring a Serial Connection for Presmaster .....	70
Cabling Requirements .....	70
Configuring the MC1-UHD for Serial Presmaster Communications .....	70
Reserving Crosspoints for Automation Use .....	71
Supported Commands .....	71
Supported Presmaster Tallies .....	74
Automation Switch Request .....	75
Take Command .....	76
<b>Using the APC Protocol</b> .....	<b>77</b>
Configuring an Ethernet Connection for APC .....	77
Configuring the MC1-UHD for Ethernet APC Communications .....	77
Configuring a Serial Connection for APC .....	78
Cabling Requirements .....	78
Configuring the MC1-UHD for Serial APC Communications .....	78
Reserving Crosspoints for Automation Use .....	79
Supported Commands .....	79
<b>Setting up an EAS with MC1-UHD</b> .....	<b>81</b>
Cabling Requirements .....	81
MC1-UHD Setup .....	81
Customizing the EAS Text Overlay .....	82
EAS Voice Over .....	83
Configuring the Audio Source for EAS .....	83
Setting the EAS Duck and Gain Levels .....	84
EAS Status .....	85
<b>On Air Control Overview</b> .....	<b>87</b>
Menu System Basics .....	87
Switcher Basics .....	88
Video Sources .....	88
Video Layering .....	88
Video Preview .....	89
DVE Transitions .....	89
Displaying the On Air Control Interface .....	89
<b>Channel Select Buttons</b> .....	<b>91</b>
Before You Begin .....	91
Updating the Icons .....	91

Graphic Files .....	92
Managing the Graphic Files .....	92
Configuring the Channel Select Buttons .....	92
<b>Audio</b> .....	<b>95</b>
Audio Overview .....	95
Workflow .....	95
Identifying the Audio Groups .....	95
Setting the Master Audio Level .....	96
Audio Processing .....	96
Voice Over Setup .....	97
Voice Overs .....	98
Setting the Voice Over Duck/Gain Level .....	98
Including a Voice Over .....	98
Audio Profiles .....	98
Creating an Audio Profile .....	99
Recalling an Audio Profile .....	99
<b>Media File Management</b> .....	<b>101</b>
Before You Begin .....	101
Managing your Media Files .....	101
Image Specifications .....	101
File Naming Specifications .....	102
Loading a Media File .....	102
Adjusting On-Air Properties .....	103
Connection using FTP .....	104
Connection using RossLinq .....	104
Using the Micro SD Card .....	104
<b>Keying</b> .....	<b>105</b>
Overview .....	105
Key Types .....	105
Key Alpha Types .....	105
Mapping the External Keys .....	105
Configuring a Key .....	106
<b>Mattes</b> .....	<b>109</b>
Setting up a Matte Color .....	109
<b>Transitions</b> .....	<b>111</b>
Before You Begin .....	111
Transition Types .....	111
Configuring the Transition Buttons .....	111
Specifying a Transition Rate .....	112
Auto Swapping of Program and Preset Buses .....	112
Resetting the Audio Gain Level After a TAKE Transition .....	113
Performing Transitions .....	113
Performing a Fade to Black .....	114
Automation Switch Request .....	114
<b>SqueezeBack Effects</b> .....	<b>117</b>
SqueezeBack Effects Controls .....	117
Working in 2D Space .....	118
Image Position in 2D Space .....	118

Configuring the DVE Transition Options .....	119
Specifying the Key Order .....	119
Configuring a SqueezeBack Preset .....	119
Performing Transitions with SqueezeBack Presets .....	120
Notes on Performing Transitions with SqueezeBack Presets .....	120
Previewing a Squeeze Effect .....	120
Transitions with SqueezeBack .....	120
Basic Transition with a Squeeze Effect .....	120
Dissolve to a Static Squeeze Effect .....	121
<b>Ancillary Data .....</b>	<b>123</b>
Supported Data Types .....	123
Specific ANC Processing .....	123
Monitoring the Encoding and Decoding of ANC Data .....	124
<b>Configuring the GPI/Tallies .....</b>	<b>125</b>
GPI Communication Setup .....	125
Configuring a Port as a GPI .....	125
Tally Communication Setup .....	126
Enabling GPI/Tally Logging .....	127
Enabling GPIs to Override Take Transitions .....	127
Using VGPIs .....	127
Assigning a SqueezeBack Preset to a VGPI .....	128
<b>Upgrading the Software .....</b>	<b>129</b>
Notes on Rebooting the Card .....	130
<b>DashBoard Interface Overview .....</b>	<b>131</b>
Global Interface .....	131
Signal Tab .....	131
Product Tab .....	132
Hardware Tab .....	133
Licensing State Tab .....	134
Setup Tab .....	134
Network Tab .....	135
Global Alarm Enables Tab .....	136
Security Tab .....	137
Configure Licenses Tab .....	137
Logging Tab .....	138
Configuration Interface .....	138
Video Format Tab .....	138
Audio Status .....	139
Alarm Enables Tab .....	140
ANC Tab .....	140
Transitions Tab .....	143
Output Selection Tab .....	144
Matte Tab .....	145
GPI/Tally Tab .....	145
Remote Control Tab .....	149
Router Control Tab .....	164
Crosspoint Map Tab .....	166
Audio Profile Names Tab .....	168
DVE Tab .....	168
Audio Over Tab .....	169
On Air Control Interfaces .....	169

Home Tab .....	169
Keyers Tabs .....	170
SqueezeBack Effects Tabs .....	172
Logo Tabs .....	173
External Keys Tab .....	174
Audio Processing Tab .....	175
Audio Shuffle Tab .....	175
Save Audio Profile Tab .....	176
Voice Over Tab .....	176
GPIO Control Tab .....	176
Control Panel .....	177
<b>Technical Specifications</b> .....	<b>181</b>
Supported Video Formats .....	181
SDI Inputs Specifications .....	181
SDI Outputs Specifications .....	182
AES Specifications .....	183
MC1-UHD-A .....	183
MC1-UHD-B .....	183
Serial Port Specifications .....	184
GPIO .....	185
Environment .....	185
Power .....	185
<b>Service Information</b> .....	<b>187</b>
Reloading the Software on the Card .....	187
Loading the Factory Defaults .....	187
Warranty and Repair Policy .....	188
<b>Software Licenses</b> .....	<b>189</b>
BSD .....	189
Dual GPL .....	189
GPL .....	189
LGPL .....	194
MIT .....	195
zlib .....	195
<b>Glossary</b> .....	<b>197</b>

# Introduction

This guide covers the installation, configuration, and use of the MC1-UHD. The following chapters are included:

- **“Introduction”** summarizes the guide and provides important terms, and conventions.
- **“Before You Begin”** provides general information to keep in mind before installing and configuring your MC1-UHD.
- **“Integration Example”** provides one possible work-flow that includes an MC1-UHD.
- **“Hardware Overview”** provides a basic introduction to the MC1-UHD hardware features including the cabling and monitoring features of the rear module.
- **“Physical Installation”** provides instructions for the physical installation of the MC1-UHD and its rear module into an openGear frame.
- **“Cabling”** provides an overview of connecting input and output devices to the rear module of the MC1-UHD.
- **“Getting Started”** outlines how to display the MC1-UHD interfaces in DashBoard.
- **“Licensed Features”** outlines the available software licensed features, and how to install a software key for a licensed feature.
- **“Reference and Video Format Setup”** provides instructions for specifying the reference source for the MC1-UHD.
- **“Configuring the Outputs”** provides instructions for setting the card output video format.
- **“Router Setup”** provides instructions for the basic physical installation and communications setup of your MC1-UHD to the Ultrix router.
- **“Crosspoint Mapping”** outlines how to specify the number of available crosspoints, and assign sources to each crosspoint.
- **“Using RossTalk”** outlines how to establish a connection point between the MC1-UHD and an external device using the RossTalk protocol.
- **“Control® DeviceMaster® Setup”** describes how to set up communications between the MC1-UHD and a Control DeviceMaster.
- **“Using TSL UMD v3.1 Protocol”** outlines how to configure the MC1-UHD to communicate with a device via the TSL UMD 3.1 protocol.
- **“Using the Presmaster Protocol”** outlines how to configure the MC1-UHD to support a subset of Miranda™ Presmaster Control System automation commands.
- **“Using the APC Protocol”** outlines how to configure the MC1-UHD to communicate with a device via the APC protocol
- **“Setting up an EAS with MC1-UHD”** outlines how to set up communications between the Sage Digital ENDEC 3644 and the MC1-UHD.
- **“On Air Control Overview”** provides a basic introduction to the MC1-UHD, including an overview of the different areas of the On Air Control interface, using the menu system, as well as a brief summary of how video is controlled by the MC1-UHD.
- **“Audio”** provides instructions for configuring the audio features of the MC1-UHD using the options available in DashBoard.
- **“Media File Management”** outlines how to select and configure the two Logo channels for the MC1-UHD.
- **“Keying”** summarizes the MC1-UHD keying features.
- **“Mattes”** outlines how to set up a matte color and assign a matte generator to an external key.
- **“Transitions”** outlines how to specify the post transition behavior, configure the TAKE button, set a transition rate, and perform basic transitions.

- “**SqueezeBack Effects**” outlines the SqueezeBack feature of the MC1-UHD.
- “**Ancillary Data**” provides an overview of ANC processing for the MC1-UHD.
- “**Configuring the GPI/Tallies**” outlines how to configure each GPI/Tally independently on the MC1-UHD.
- “**Upgrading the Software**” outlines how to upgrade the MC1-UHD via DashBoard.
- “**DashBoard Interface Overview**” summarizes the menus and parameters of the MC1-UHD tabs in DashBoard.
- “**Technical Specifications**” provides the specifications for the MC1-UHD.
- “**Service Information**” provides information on the warranty and repair policy for your MC1-UHD.
- “**Software Licenses**” provides third-party software license information for your MC1-UHD.
- “**Glossary**” provides a list of terms used throughout this guide.

## Related Publications

It is recommended to consult the following Ross documentation before installing and configuring your MC1-UHD:

- ***DashBoard User Manual***, Ross Part Number: 8351DR-004
- ***MC1-PANEL-16 User Manual***, Ross Part Number: 8800DR-004
- ***MFC-OG3-N and MFC-8322-S User Manual***, Ross Part Number: 8322DR-004
- ***OGX-FR Series User Manual***, Ross Part Number: 8322DR-204

## Documentation Conventions

Special text formats are used in this guide to identify parts of the user interface, text that a user must enter, or a sequence of menus and sub-menus that must be followed to reach a particular command.

### Interface Elements

Bold text is used to identify a user interface element such as a dialog box, menu item, or button. For example:

In the **Network** tab, click **Apply**.

### User Entered Text

Courier text is used to identify text that a user must enter. For example:

In the **Language** box, enter `English`.

### Referenced Guides

Text set in bold and italic represent the titles of referenced guides, manuals, or documents. For example:

For more information, refer to the ***DashBoard User Manual***.

### Menu Sequences

Menu arrows are used in procedures to identify a sequence of menu items that you must follow. For example, if a step reads “**File** > **Save As**,” you would select the **File** menu and then click **Save As**.

## Important Instructions

Star icons are used to identify important instructions or features. For example:

- ★ Contact your IT department before connecting to your facility network to ensure that there are no conflicts. They will provide you with an appropriate value for the IP Address, Subnet Mask, and Gateway for your device.

## Contacting Technical Support

At Ross Video, we take pride in the quality of our products, but if problems occur, help is as close as the nearest telephone.

Our 24-hour Hot Line service ensures you have access to technical expertise around the clock. After-sales service and technical support is provided directly by Ross Video personnel. During business hours (Eastern Time), technical support personnel are available by telephone. After hours and on weekends, a direct emergency technical support phone line is available. If the technical support person who is on call does not answer this line immediately, a voice message can be left and the call will be returned shortly. This team of highly trained staff is available to react to any problem and to do whatever is necessary to ensure customer satisfaction.

- **Technical Support:** (+1) 613-652-4886
- **After Hours Emergency:** (+1) 613-349-0006
- **E-mail:** [techsupport@rossvideo.com](mailto:techsupport@rossvideo.com)
- **Website:** <http://www.rossvideo.com>





# Before You Begin

If you have questions pertaining to the operation of MC1-UHD, contact us at the numbers listed in **“Contacting Technical Support”**. Our technical staff is always available for consultation, training, or service.

## Overview

MC1-UHD is a software-defined UHD Master Control solution for the GATOR platform, which allows mixing, keying, and logo insertion up to UHD rates. With native 12G-SDI interfaces, you won't get bogged down with multi-link interfaces in your UHD work-flow. This allows easy insertion of external key sources, like our XPression 4K. MC1-UHD also features an internal animated logo store. Using RossLinq, logos can be transferred directly from XPression to the MC1-UHD on-air frame buffer seamlessly.

MC1-UHD features a suite of protocol support for automation control, and router control.

★ The MC1-UHD must be installed in an OGX-FR frame with an MFC-OG3-N or MFC-OGX-N Network Controller card.

## Features

Some features of the MC1-UHD include:

- 6 x 12G SDI Inputs (Background, Preset, 2xKey/Fill)
- 6 assignable 12G SDI Outputs (Program, Preview, Clean Feeds)
- Support for SD, HD, and UHD video formats
- 2 External Key + Alpha can come from any SDI input or any of the 2 logo channels
- Keys can be transitioned independently
- Support for cross fade, cut, v fade, fade/cut, and cut/fade transitions
- 2 internal logo/animation play-out channels
- Logo animations up to full screen
- Non-volatile logo storage via the Micro SD Card
- Rossling interface to XPression LiveCG
- Ultrix Router Support
- Automation Support via the Presmaster protocol
- RossTalk support
- APC support
- GPI control
- Clean/quiet transitions
- An optional AES daughter card provides 8 Balanced AES or 8 unbalanced AES inputs per channel
- Support for on-air 2D DVE (SqueezeBack) transitions
- Stand-alone SqueezeBack
- Stand-alone audio/voice over mixing
- Audio processing for 16 embedded audio channels
- Audio shuffling from any embedded input (or mute or tone) for each embedded output
- Clean audio switching for embedded audio at 48kHz

- Configure up to 4 audio profiles that can be recalled on any crosspoint
- Fully compliant with openGear specifications
- 5 year transferable warranty

## Functional Block Diagram

Figure 1 provides a general overview of the MC1-UHD workflow.

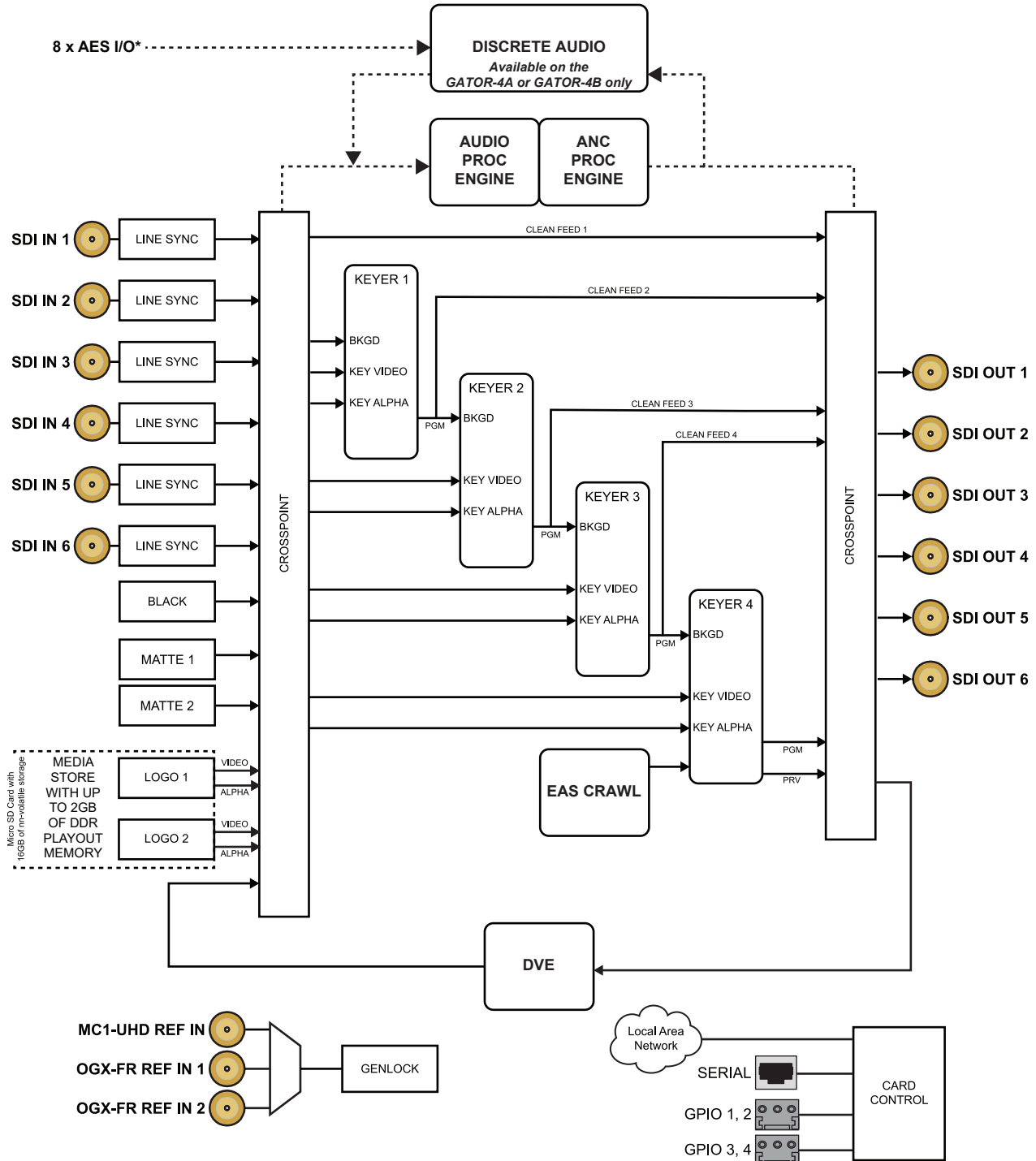

\* The type of AES connections (balanced or unbalanced) depends on the rear module installed with the card.

Figure 1 Functional Block Diagram — Workflow

## User Interfaces

Control is available via the DashBoard client software, through third-party protocols, and the optional MC1-PANEL-16 control panel.

### DashBoard Interfaces

The DashBoard client software enables you to monitor and control openGear frames and cards from a computer. DashBoard communicates with cards in the openGear frames through an MFC-OG3-N or MFC-OGX-N installed in the frame. This controller card is required in order to use DashBoard to control and monitor the MC1-UHD.

The MC1-UHD includes DashBoard interfaces for configuration and operation. The interfaces are accessed by expanding the MC1-UHD node in the DashBoard Tree View and selecting the appropriate sub-node.

#### For More Information on...

- displaying the DashBoard interfaces, refer to the chapter “**Getting Started**”.

### Third-Party Protocols

The MC1-UHD supports a communication link between a computer based editing or automation system and the MC1-UHD.

#### For More Information on...

- setting up an automation system with the MC1-UHD, refer to the chapters “**Using RossTalk**”, and “**Using the Presmaster Protocol**”.

### MC1-PANEL-16

The MC1-PANEL-16 is a stand-alone control panel that provides all the basic user input of the MC1-UHD card (channel) it is controlling. Up to 10 channels can be configured independently, allowing a single MC1-PANEL-16 to communicate and control 10 cards.

#### For More Information on...

- configuring an MC1-PANEL-16, refer to the ***MC1-PANEL-16 User Manual***.



# Integration Example

MC1-UHD offers 6 configurable outputs with selections for PGM / PREVIEW and CLEAN. The look-ahead PREVIEW is ideal for live productions providing confidence in quality and accuracy of the next scene to go to air.

## System Integration Example

The setup seen in **Figure 2** includes the following:

- An ULTRIX-FR5 with one Multiviewer Head output and 6 SDI outputs to the MC1-UHD
- One MC1-UHD with a PREVIEW output, a PROGRAM output, and 4 SDI outputs to the ULTRIX-FR5
- One XPression with a Rossling data connection to the OGX-FR frame
- A Master Control Automation System
- A DashBoard client computer with a network connection

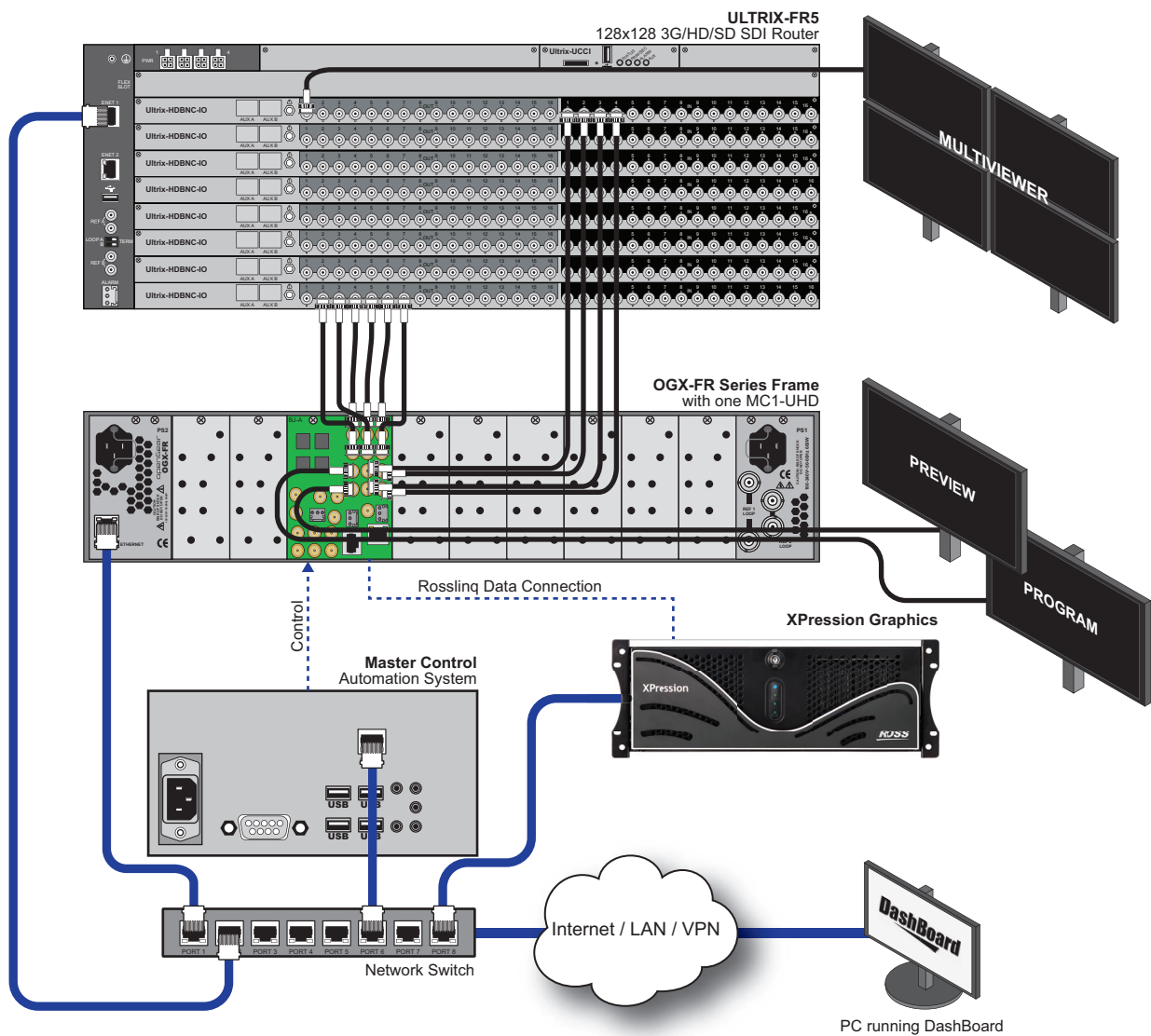

Figure 2 Example of Integrating the MC1-UHD with an Existing System

## Physical Setup Overview

The user needs to physically install the MC1-UHD and ensure the following tasks are performed:

1. Install and configure the openGear frame that houses the MC1-UHD.
2. Install the rear module into the rear panel of the frame.
3. Install the MC1-UHD into its rear module.
4. Connect the SDI signals to the MC1-UHD rear module.

## Network Settings Overview

Now the user needs to connect the MC1-UHD to the network and ensure it can communicate with a computer running the latest DashBoard client software. The DashBoard client software enables you to monitor, configure, and operate your MC1-UHD.

The user must perform the following tasks to access and configure the MC1-UHD:

1. Verify that a computer running the latest DashBoard client software is installed and available on the same subnet as the MC1-UHD. The DashBoard client software and user guide are available from our website.
2. Verify that the openGear frame displays in the Tree View of DashBoard. Refer to the **OGX-FR Series User Guide** for details.
3. Set up network communications for the MC1-UHD as outlined in **“Configuring the Initial Network Settings”**.
4. Display the MC1-UHD in DashBoard as outlined in **“Accessing the MC1-UHD Interfaces in DashBoard”**.

## Configure the MC1-UHD

The MC1-UHD is now ready for configuration. To complete the setup, the user must:

1. Select a valid reference source. Refer to **“Specifying a Global Reference Source”**.
2. Specify the video signal for each of the six SDI outputs. Refer to **“Specifying the Outputs”**.
3. Configure the MC1-UHD to communicate with the Ultrix router. Refer to **“Router Setup”**.
4. Map the crosspoints buses on the MC1-UHD. Refer to **“Crosspoint Mapping”**.
5. Configure the MC1-UHD as a client to the Master Control Automation device. For a Miranda™ Presmaster Control System, refer to **“Using the Presmaster Protocol”**.

## XPression Setup Requirements

To set up communications between XPression and MC1-UHD:

1. Ensure the RossLinq channel in XPression is set as a passive FTP connection. Refer to the **XPression User Guide** for details.
2. Establish an FTP connection between MC1-UHD and XPression. Refer to **“Connection using RossLinq”**.

# Hardware Overview

This chapter presents information on the MC1-UHD card and rear module.

## Overview

The MC1-UHD is an openGear modular system composed of two sub-systems.

- a main board which connects to a rear module and the openGear frame midplane
- a rear module that provides physical connectors

**Table 1** outlines which rear module mates with specific MC1-UHD PCB version and openGear frames.



**Notice** — Installing the MC1-UHD in a frame other than the OG3-FR or OGX-FR could damage the card, the rear module, or both.

**Table 1 Rear Modules — Supported openGear Frames**

Code Displayed in Dashboard	Main PCB Marketing Code	PCB Part Number	Rear Module Marketing Code	Rear Module Part Number	Number of Frame Slots	Supported openGear Frame
MC1-UHD	GATOR-2	8929AR-251	R4-GATOR	8323AR-325	2	OGX-FR
MC1-UHD-A	GATOR-4A	8929AR-253	R3A-GATOR	8322AR-319C	4	OG3-FR, OGX-FR
MC1-UHD-B	GATOR-4B	8929AR-254	R3B-GATOR	8322AR-318D	4	OG3-FR, OGX-FR

## Main PCB Overview

The main PCB is a typical openGear card. An ejector on one end secures the card to the slot inside the openGear frame, and the other end inserts into a connector on the back of the rear module.

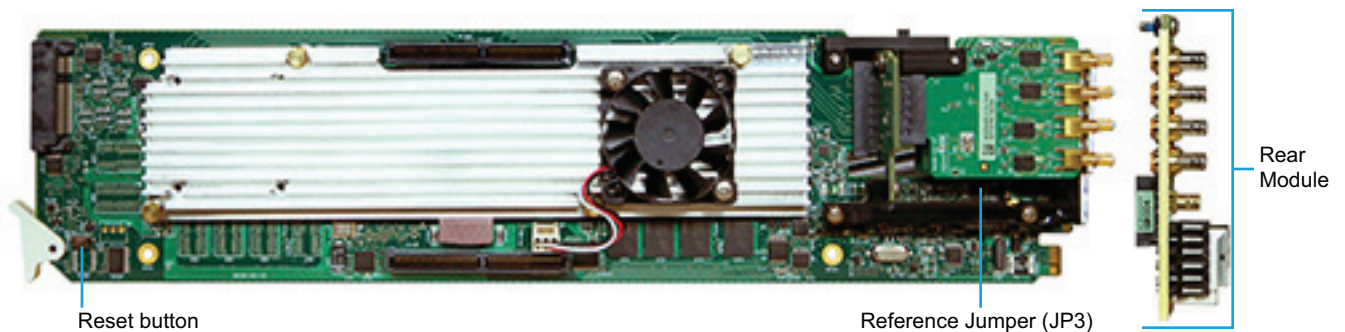

Figure 3 MC1-UHD — Base Card Components

### Reset Button

Pressing this button performs a hard reset of the microprocessor and re-initializes the card. This should only be performed if advised by Ross Video Technical Support.

### Reference Termination Jumper (JP3)

**JP3** is a 3-position jumper block used to configure the 75ohm termination on the local reference input on the rear module.

- **Pin 1** (bottom) + **Pin 2** (center) — In this position, the reference is terminated with a 75ohm resistor. This configuration is to be used for point-to-point cabling, or on the last card of a daisy chain topology. This is the default position. Refer to **Figure 4** for pin positions.

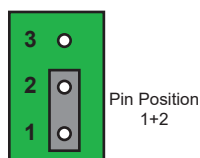

Figure 4 J3 — Default Position

- **Pin 2** (center) + **Pin 3** (top) — In this position, the 75ohm termination is removed and the reference is not terminated. This configuration is used in a daisy chain cabling topology where only the last card is terminated.

## Back Components (Not Shown)

The Micro SD card slot is located on the backside of the main PCB and just above the ejector.

★ Ensure the SD card is properly seated in its slot before installing the MC1-UHD.

## Audio Daughter Card

The MC1-UHD-A and MC1-UHD-B include a daughter card installed on the main PCB. This daughter card is required for the audio features of the MC1-UHD-A and MC1-UHD-B.

## MC1-UHD Cabling Overview

This section provides an overview of the connections and cabling designations when the MC1-UHD is installed with the R4-GATOR rear module. (**Figure 5**) The following connections are available:

- 6 SDI inputs on HD-BNCs
- 6 SDI outputs on HD-BNCs
- 1 local reference input signal
- 4 GPIO connections

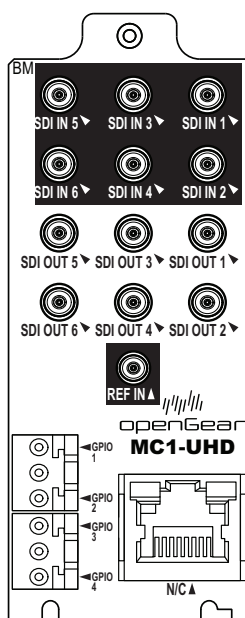

Figure 5 Cabling Designations — R4-GATOR (8323AR-325) Rear Module



## MC1-UHD-A Cabling Overview

The MC1-UHD-A requires the R3A-GATOR rear module. **(Figure 6)** The following connections are available:

- 6 SDI inputs on HD-BNCs
- 6 SDI outputs on HD-BNCs
- 8 AES unbalanced connections on HD-BNCs
- 1 local reference input signal
- 1 SERIAL port
- 6 GPIO connections

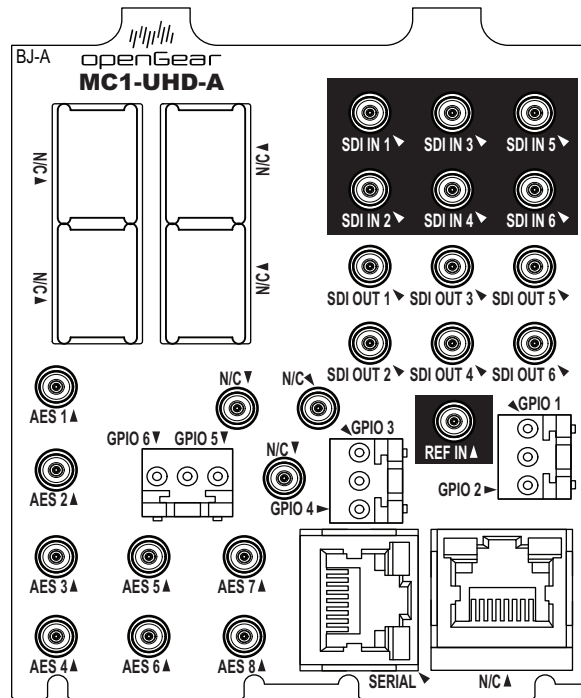

Figure 6 Cabling Designations — R3A-GATOR (8322AR-319C) Rear Module

## MC1-UHD-B Cabling Overview

The MC1-UHD-B requires the R3B-GATOR rear module. **(Figure 7)** The following connections are available:

- 6 SDI inputs on HD-BNCs
- 6 SDI outputs on HD-BNCs
- 8 AES balanced connections on 3-pin connectors
- 6 GPIO connections
- 1 SERIAL port
- 1 independent reference input signal (bi-level or tri-level sync)

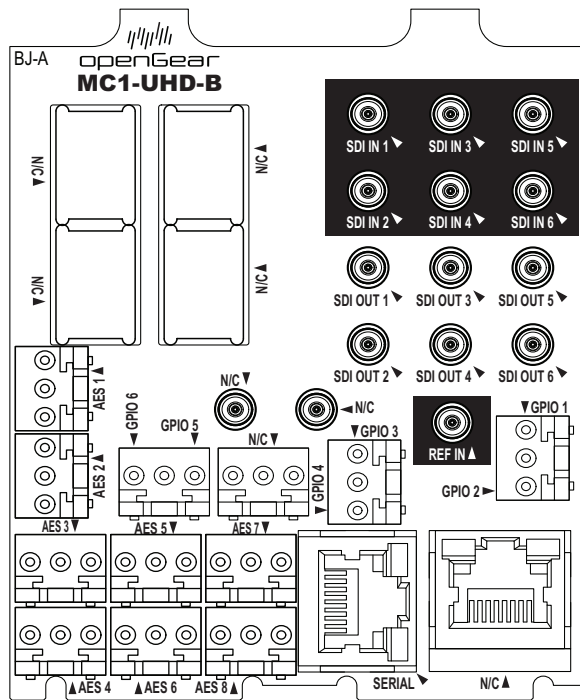

Figure 7 Cabling Designations — R3B-GATOR (8322AR-318D) Rear Module

# Physical Installation

Installing an MC1-UHD card into the OGX-FR frame requires you to remove the blank plates in the designation frame slots, install the required rear module into the frame rear panel, and then install the MC1-UHD card into the required frame slot.

If you have questions pertaining to the installation of MC1-UHD, contact us at the numbers listed in “**Contacting Technical Support**”. Our technical staff is always available for consultation, training, or service.

## For More Information on...

- the technical specifications for the MC1-UHD, refer to “**Technical Specifications**”.

## Before You Begin

These installation guidelines assume the following:

- Ensure the OGX-FR frame is properly installed. Refer to the **User Guide** for your frame.
- An MFC-OG3-N or MFC-OGX-N Network Controller Card installed in your OGX-FR frame.
- A valid IP address is available for the MC1-UHD.
- If the rear module is already installed in the OGX-FR frame, proceed to “**Installing the MC1-UHD into an OGX-FR Frame**”

## Static Discharge

Throughout this chapter, please heed the following cautionary note:



**ESD Susceptibility** — *Static discharge can cause serious damage to sensitive semiconductor devices. Avoid handling circuit boards in high static environments such as carpeted areas and when synthetic fiber clothing is worn. Always exercise proper grounding precautions when working on circuit boards and related equipment.*

## Removing the Blank Plates from the Rear Panel

When a frame slot is not populated with an openGear card, a blank plate must be installed to ensure proper frame cooling and ventilation.



**Notice** — *Installing the R4-GATOR (8323AR-325) rear module in a frame other than the OGX-FR could damage the card, the rear module, or both.*

### To remove a blank plate from the OGX-FR frame

1. Locate the slots in the OGX-FR frame you wish to install the MC1-UHD into.
2. If you are using an R3B-GATOR (8322AR-318D) or R3A-GATOR (8322AR-319C) rear module, it is recommended to use the following slot combinations:
  - Slots 1, 2, 3, 4
  - Slots 5, 6, 7, 8
  - Slots 9, 10, 11, 12
  - Slots 13, 14, 15, 16
  - Slots 17, 18, 19, 20
3. Use a Phillips screwdriver to unfasten each blank plate from the OGX-FR frame backplane.
4. Remove each blank plate from the chassis and set aside.

- ★ You must remove two Blank Plates (covering four slots) in the OGX-FR frame when installing an 8322AR-319C rear module.

## Installing the Rear Module into the OGX-FR Frame

If the rear module is already installed in the OGX-FR frame, proceed to “**Installing the MC1-UHD into an OGX-FR Frame**”.

### To install a rear module into the OGX-FR frame

1. For each retaining screw on the rear module, push the o-ring to the end of the screw (but not off the screw). This will help to align the rear module to the frame backplane in step 3.

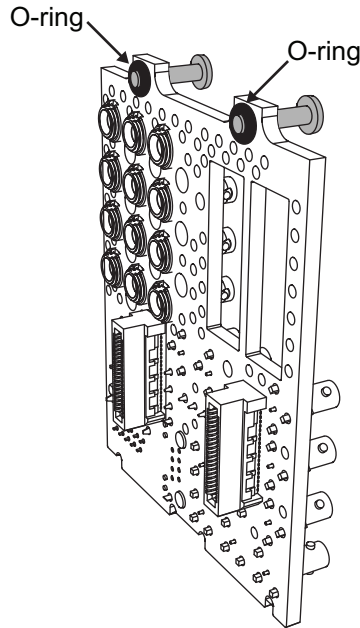

*Figure 8 Location of the O-ring on the R3B-GATOR or R3A-GATOR Rear Module*

2. Seat the bottom of the rear module in the seating slots at the base of the frame’s backplane.
  3. Align the top holes of the rear module with the screw holes on the top-edge of the frame backplane.
  4. Using a Phillips screwdriver and the provided screw, fasten the rear module to the backplane.
- ★ Do not fully tighten the screws until after installing the card and you have verified that the main PCB aligns with the rear module.

## Installing the MC1-UHD into an OGX-FR Frame

The slot the MC1-UHD installs into depends on the slot combination you installed the rear module in. This allows adequate spacing to avoid damaging the card, the cards installed in the neighboring slots, or both.

Refer to **Table 2** for valid slot combinations when using an R3B-GATOR (8322AR-318D) or R3A-GATOR (8322AR-319C) rear module.

**Table 2 Card Slot Combinations — R3B-GATOR (8322AR-318D), R3A-GATOR (8322AR-319C)**

Rear Module is Installed in	Main PCB Installs into Slot
Slots 1, 2, 3, 4	2
Slots 5, 6, 7, 8	6
Slots 9, 10, 11, 12	10
Slots 13, 14, 15, 16	14
Slots 17, 18, 19, 20	18

Refer to **Table 3** for valid slot combinations when using the R4-GATOR (8323AR-325) rear module.

**Table 3 Card Slot Combinations — R4-GATOR (8323AR-325)**

Rear Module is Installed in	Main PCB Installs into Slot
Slots 1, 2	1
Slots 3, 4	3
Slots 5, 6	5
Slots 7, 8	7
Slots 9, 10	9
Slots 11, 12	11
Slots 13, 14	13
Slots 15, 16	15
Slots 17, 18	17
Slots 19, 20	19

**To install the card into the OGX-FR frame**

1. Locate the frame slot the card will slide into.
2. Using a Phillips screwdriver fasten the rear module to the backplane using the provided screws.  
★ Do not over tighten the screws.
3. Hold the card by the edges and carefully align the card edges with the slot rails in the frame.
4. Fully insert the card into the frame until the card is properly seated in the rear module.



# Cabling

If you have questions pertaining to the installation of MC1-UHD, contact us at the numbers listed in “**Contacting Technical Support**”. Our technical staff is always available for consultation, training, or service.

- ★ The examples in this chapter depict each rear module installed in a single OGX-FR frame. Your setup may differ than what is presented here.
- ★ Ross Video does not supply the required cables.

## Cabling the Ethernet Port on the OGX-FR Frame

The MC1-UHD is connected to your network via the MFC-OG3-N or MFC-OGX-N in the OGX-FR frame. This enables the MC1-UHD to interface with other cards in the frame, and the computer running the DashBoard client. After a physical connection is established, DashBoard is used to configure the network settings for the MC1-UHD.

- ★ You must provide an Ethernet connection to the frame as outlined in the **OGX-FR Series User Guide**.

Contact your IT department before connecting to your facility network to ensure that there are no conflicts. They will provide you with an appropriate value for the IP Address, Subnet Mask, and Gateway for your MC1-UHD.

- ★ If difficulties or problems are experienced when connecting to a network hub, contact your network administrator.

## Cabling for the MC1-UHD Local Reference Input

The OGX-FR frame provides two reference input connections that the MC1-UHD can use as a reference source. Refer to the **OGX-FR Series User Guide** to learn more about cabling these ports.

Each MC1-UHD rear module also includes a **REF IN** HD-BNC that can be assigned as a local reference input. This section outlines how to connect to this reference input port. There is also the option to specify the signal on the SDI IN 1 port as the reference source.

### For More Information on...

- on specifying the reference source for your card, refer to “**Reference and Video Format Setup**”.

### To connect a reference source to the MC1-UHD rear module

- Connect the reference signal to the **REF IN** HD-BNC on the MC1-UHD rear module.
- ★ By default, the reference input on the MC1-UHD is terminated. You may disable the termination by moving **J3** on the rear module. Refer to “**Reference Termination Jumper (J3)**” for details.

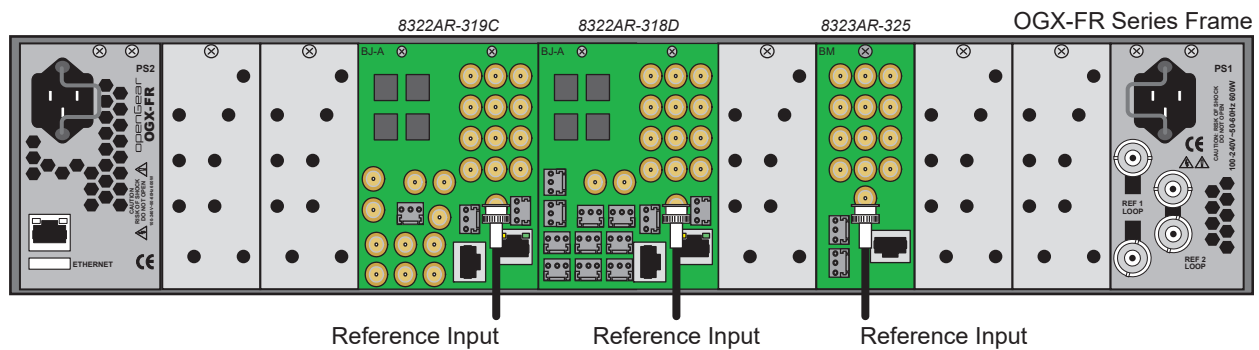

Figure 9 Rear Module Cabling — Reference Source (REF IN)

## Video Signal Cabling

Each rear module provides connections for up to six SDI inputs and six SDI outputs.

### SDI Inputs

Connect your input video signals to the SDI IN HD-BNCs on the rear module as required. (Figure 10)

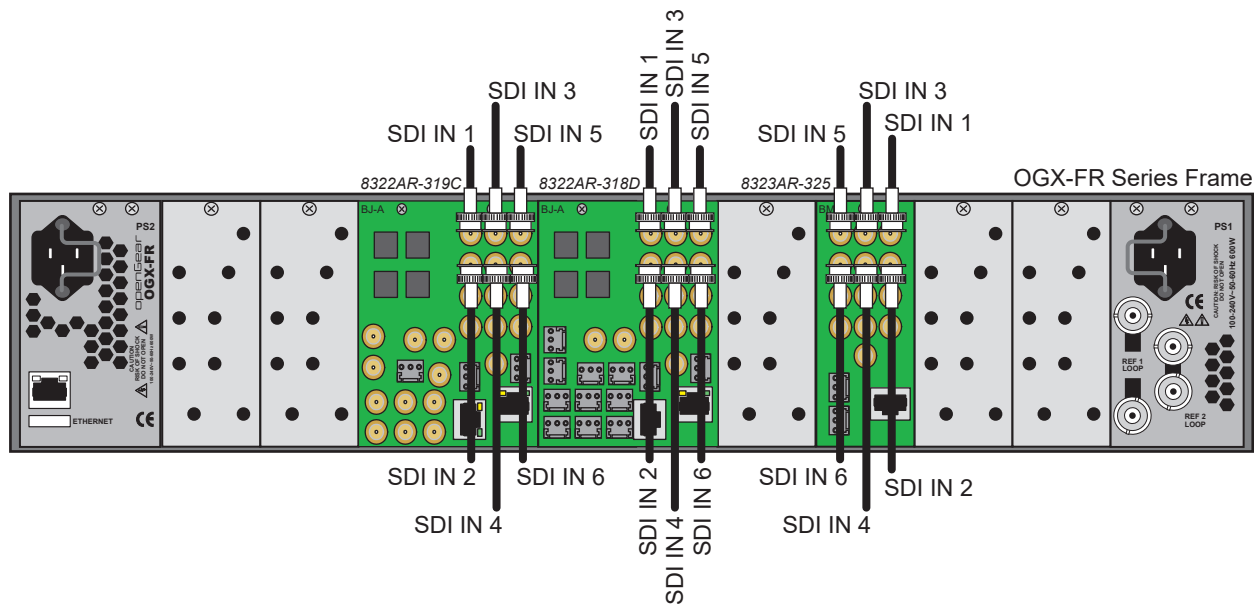

Figure 10 Rear Module Cabling — SDI Inputs

★ SDI IN 1 can be used as a reference source. Refer to “**Specifying a Global Reference Source**”.

### SDI Outputs

Connect your destination devices to the SDI OUT HD-BNCs on the rear module as required. There are six HD-BNC SDI outputs available on each rear module. (Figure 11)



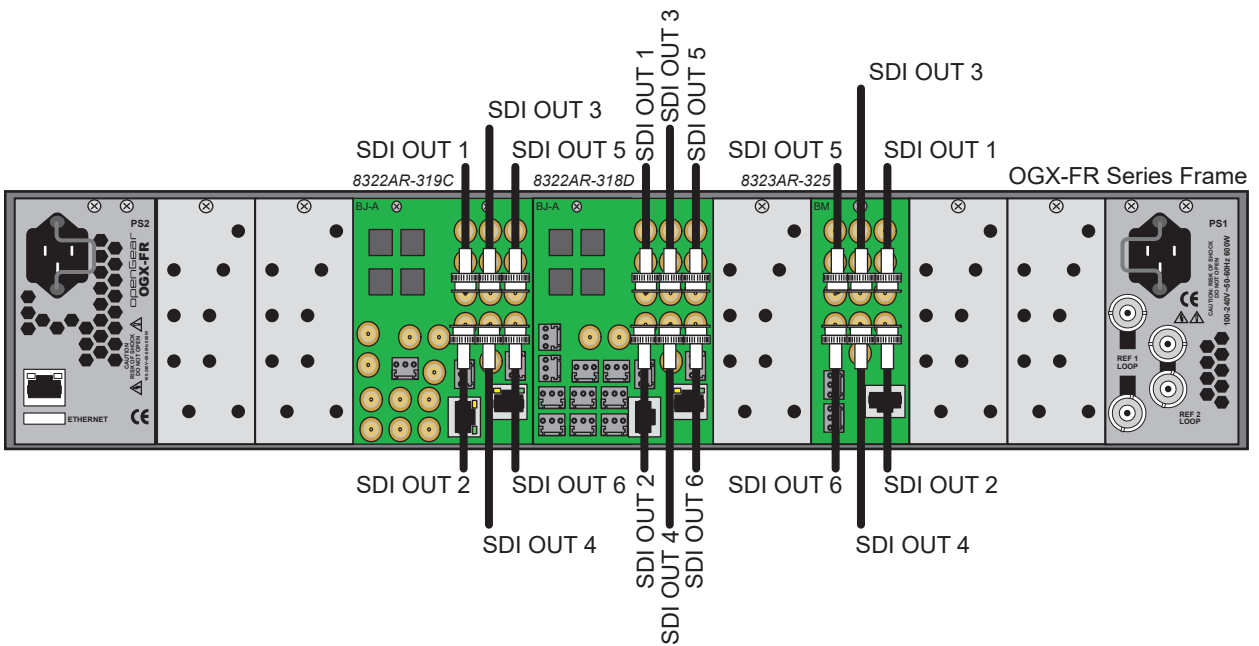

Figure 11 Rear Module Cabling — SDI Outputs

## Serial Cabling

If the MC1-UHD will communicate with an external device via a Serial communications protocol, you will also need to connect this device to the **SERIAL** port on the MC1-UHD rear module. (Figure 12)

★ This section applies only to the R3B-GATOR (8322AR-318D) or R3A-GATOR (8322AR-319C) rear modules. The R4-GATOR (8323AR-325) rear module does not include a **SERIAL** port.

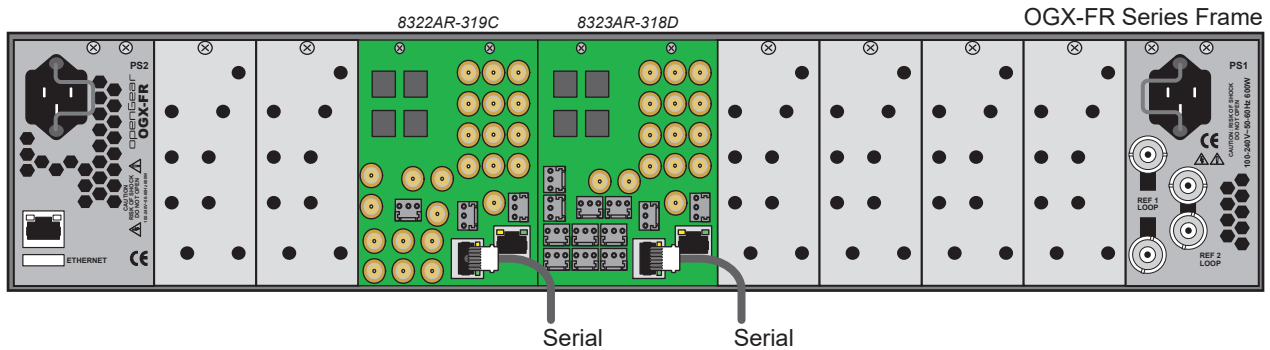

Figure 12 Rear Module Cabling — Serial Connection

Refer to **Table 4** for pin-outs for the **SERIAL** port on the rear modules.

**Table 4 Serial Pinouts on the MC1-UHD**

RJ45 Pin	RS-232	RS-422
1	n/c	Tx+
2	Rx	Tx-
3	Tx	Rx+
4	n/c	n/c
5	n/c	n/c
6	n/c	Rx-
7	GND	GND
8	GND	GND

## GPI/Tally Cabling

The GPIO ports are user programmable to be either an input (GPI) or an output (Tally) using the GPI/Tally Setup tab in DashBoard. Electrically, the ports are setup for contact closure to ground, with 4.75kohm pull-up resistor to +5V, so they default to a logical high state.

The ports are available on two 3-pin connectors located on each rear module. The 3-pin mating connectors are provided with the rear module. The default state for the GPIO contacts is active low signaling. This way, if the card is removed from the openGear frame, no external events will be inadvertently asserted by the card. This also means that if a cable is absent from the rear module, no GPI or Tally will be triggered and executed inadvertently by the card.

★ The number of available GPIO ports depends on the rear module you are using. The R3B-GATOR (8322AR-318D) and R3A-GATOR (8322AR-319C) rear modules each provide 6 GPIO ports. The R4-GATOR (8323AR-325) rear module provides 4 GPIO ports.

Connect your destination devices to the GPIO pins on the rear module as required. **(Figure 13)**

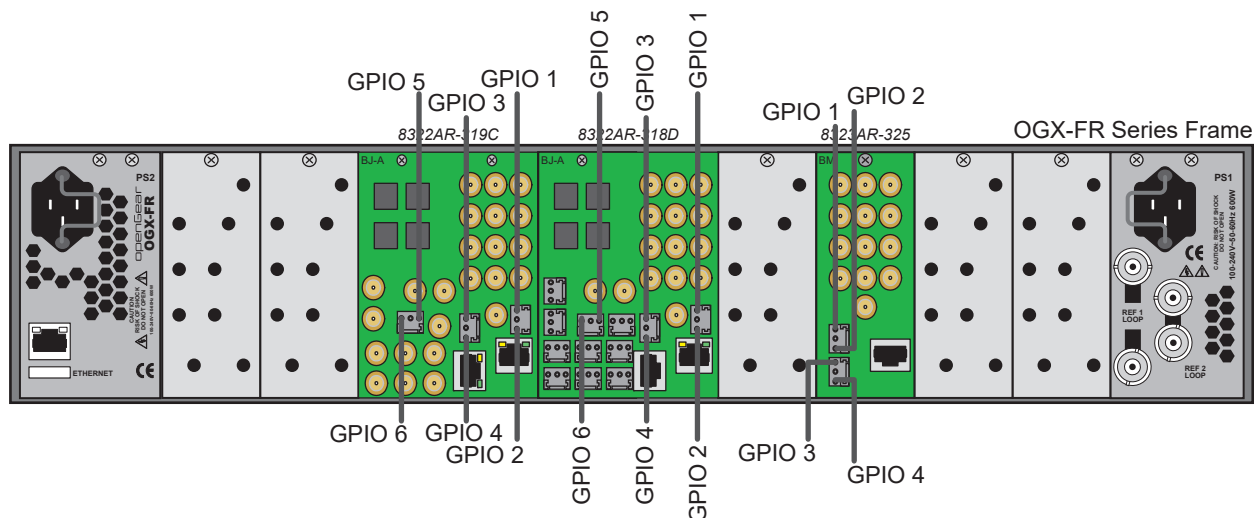

*Figure 13 Rear Module Cabling — GPIO*

### For More Information on...

- the GPIO specifications, refer to **Table 70**.
- configuring a GPIO port via DashBoard, refer to **“Configuring the GPI/Tallies”**.

## Audio Cabling

The R3B-GATOR rear module provides eight balanced audio connections on 3-pin connectors. This rear module is required for the MC1-UHD-B. Cable your rear module using the following procedure.

### To wire the audio for the R3B-GATOR rear module

1. Insert an audio wire to the designated polarity slot on the connector of the rear module.

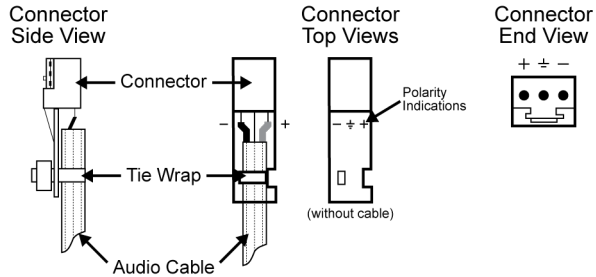

2. Use a tweaker screwdriver to tighten the corresponding capture screw.
3. Repeat steps 1 and 2 for each wire on each connector.
4. Once the cables are wired to the connectors, install the connectors on the terminal blocks for the rear module.



# Getting Started

This chapter provides instructions for launching DashBoard, assigning an initial IP address to the MC1-UHD, and accessing the MC1-UHD interfaces in DashBoard.

If you have questions pertaining to the operation of MC1-UHD, contact us at the numbers listed in “**Contacting Technical Support**”. Our technical staff is always available for consultation, training, or service.

## Before You Begin

Ensure that:

- The openGear frame that houses the MC1-UHD displays in the Basic Tree View of DashBoard.
- The MC1-UHD displays as a sub-node in the openGear frame tree.
- Your facility IT Department provided the required network settings to be assigned to the MC1-UHD.

## Launching DashBoard

DashBoard must run on a computer that has a physical wired Ethernet connection. Wireless connections do not allow device discovery.

### For More Information on...

- downloading and installing the DashBoard client software, refer to our website.
- the MC1-UHD interfaces in DashBoard, refer to “**DashBoard Interface Overview**”.

### To launch DashBoard

1. Ensure that you are running DashBoard software version 9.5 or higher.
2. Launch DashBoard by double-clicking its icon on your computer desktop.

## Configuring the Initial Network Settings

Once the MC1-UHD is physically installed and cabled to your facility network, you will need to assign it an initial IP Address in order to gain full access to the card menus, options, and status fields in DashBoard. Establishing an initial IP Address enables DashBoard to communicate with the MC1-UHD and update the Basic Tree View with the MC1-UHD sub-node.

★ This IP Address must be different that the IP Address assigned to the Frame Controller Card.

★ This procedure requires a reboot of the card.

### To assign the initial network settings for the MC1-UHD

1. Launch DashBoard.
2. Expand the openGear frame node to display a list of cards installed in that frame.

In the example below, the MC1-UHD card is installed in Slot 11 of Frame\_10.

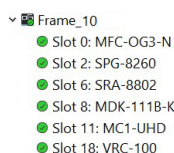

3. Double-click the **MC1-UHD** node under the frame node.  
The **Network** interface displays in DashBoard.
4. Select the **Network** tab.
5. Use the **Mode** menu to select **Static**.
6. Use the **Static IP Address** field to assign a unique IP Address to the MC1-UHD card.
7. Use the **Subnet Mask** field to assign the subnet mask for the card.
8. Use the **Gateway** field to specify the gateway for communications outside of the local area network (LAN) the card will use.
9. Click **Apply**.

The card is temporarily taken off-line during the reboot of the card to apply the new settings.

10. Verify the new network settings as follows:
  - a. Close the **Network** interface.
  - b. Refresh the Basic Tree View.
  - c. Expand the openGear frame node to display a list of sub-nodes.
  - d. Verify that the MC1-UHD sub-nodes display as seen in Slot 11 of the example below.

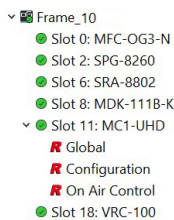

## Accessing the MC1-UHD Interfaces in DashBoard

Once you establish the initial network settings for the MC1-UHD, you can access the Global, Configuration, and On Air Control interfaces. These interfaces provide options for configuring, monitoring, and operating your MC1-UHD in DashBoard.

### For More Information on...

- the Global interface tabs, refer to “**Global Interface**”.
- the Configuration interface tabs, refer to “**Configuration Interface**”.
- the On Air Control interface, refer to “**On Air Control Interfaces**”.

### To display the Global interface in DashBoard

1. Launch DashBoard.
2. In the Basic Tree View of DashBoard, locate the openGear frame the MC1-UHD is installed in.
3. Expand the openGear frame node to display a list of sub-nodes.  
Each sub-node represents a specific card installed in a frame slot.
4. Locate the MC1-UHD sub-node.
- ★ Look for the slot number that corresponds to the physical frame slot the MC1-UHD is installed in.
5. Expand the MC1-UHD node to display a list of sub-nodes for the card.
6. Double-click the **Global** sub-node.

The Global interface opens in the right pane of the DashBoard window. The tabs in the Global interface enable you to monitor the overall status of the MC1-UHD software and hardware, configure the network settings for Ethernet communications, and enable alarms.

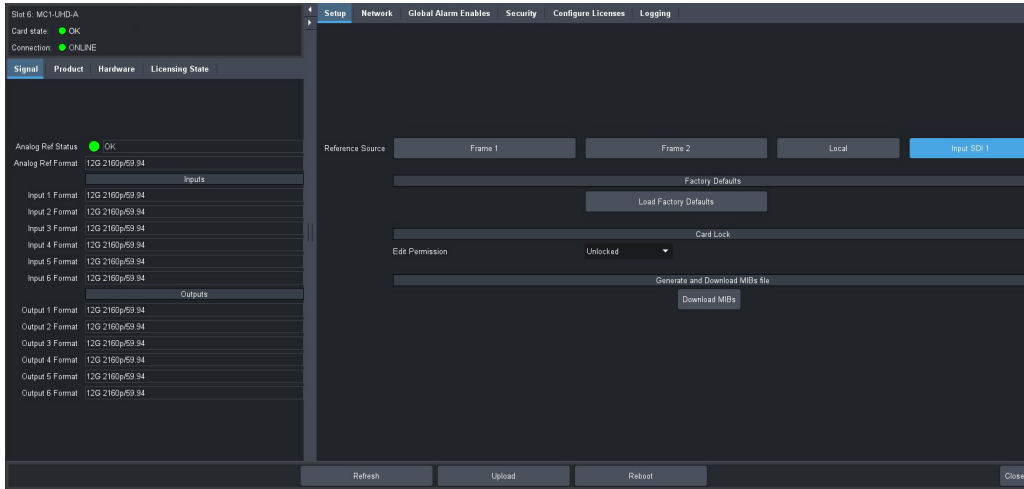

### To display the Configuration interface in Dashboard

1. Launch Dashboard.
2. In the Basic Tree View of Dashboard, locate the openGear frame the MC1-UHD is installed in.
3. Expand the openGear frame node to display a list of sub-nodes.  
Each sub-node represents a specific card installed in a frame slot.
4. Locate the MC1-UHD node in the frame tree.
- ★ Look for the slot number that corresponds to the physical frame slot the MC1-UHD is installed in.
5. Expand the MC1-UHD node to display a list of sub-nodes for the card.
6. Double-click the **Configuration** sub-node.

The Configuration interface opens in the right pane of the DashBoard window. The tabs in the Configuration interface enable you to configure the outputs, transitions, the matte generators, the box masks, and GPI/Tally communications.

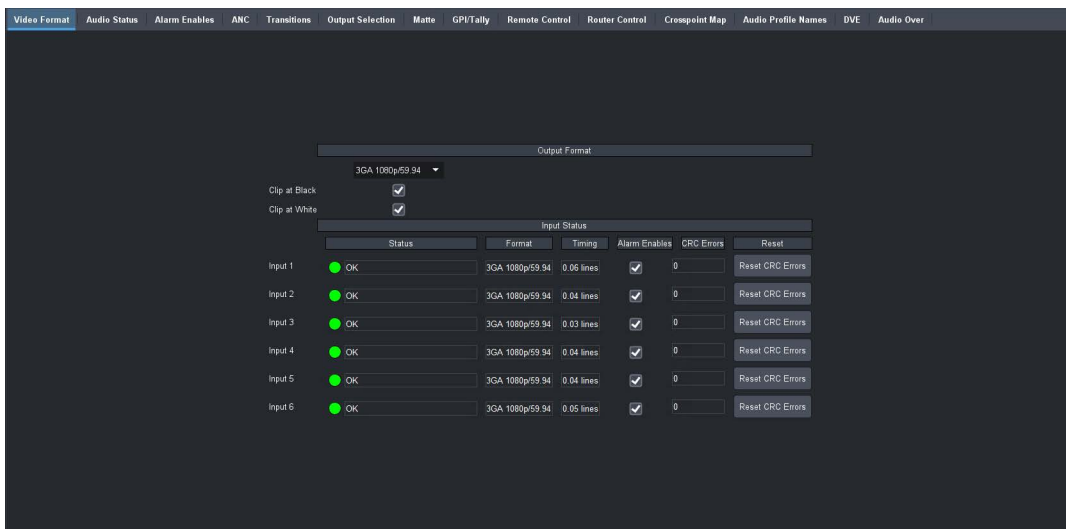

## To display the On Air Control interface in Dashboard

1. Launch Dashboard.
2. In the Basic Tree View of Dashboard, locate the openGear frame the MC1-UHD is installed in.
3. Expand the openGear frame node to display a list of sub-nodes.  
Each sub-node represents a specific card installed in a frame slot.
4. Locate the MC1-UHD node in the frame tree.
- ★ Look for the slot number that corresponds to the physical frame slot the MC1-UHD is installed in.
5. Expand the MC1-UHD node to display a list of sub-nodes for the card.
6. Double-click the **On Air Control** sub-node.

The On Air Control interface opens in the right pane of the Dashboard window. This interface enables you to set up and perform transitions, configure keys, monitor and control audio levels.



## To lock the MC1-UHD interface

1. To lock the interface, select .
- ★ This button is located in the upper right corner of the On Air Control interface.
2. To unlock the interface, use the provided Unlock spinner.

## Configuring the Remote Logging Feature

The MC1-UHD enables you to implement a streaming log that captures status information of the system via Port 514. This feature is useful for troubleshooting.

- ★ A centralized Syslog server must be installed in your system. Refer to the documentation that accompanied your centralized Syslog server for installation and setup information.

### To configure the remote logging feature

1. Navigate to the **Global** interface as outlined in **“To display the Global interface in Dashboard”**.
2. Select the **Logging** tab.
3. Use the **Remote Logging** field to specify the IP Address of the device that will capture and store the status information of the MC1-UHD.



★ You must press **Enter** after typing the IP Address into the **Remote Logging** field.

4. Reboot the MC1-UHD card as follows:
  - a. Click **Reboot**. This button is located on the bottom of the tab.
  - b. Monitor the reboot progress.

## Security Configuration

Secure Shell (SSH) Login is a client-server protocol used by system administrators to securely log onto remote systems and execute commands over an unsecured network. SSH may also be used by Technical Support for advanced troubleshooting. This service is disabled by default on the MC1-UHD.



# Licensed Features

The MC1-UHD has software licenses for enabling functions and features of the card. This chapter outlines the available software licensed features, and how to install a software key for a licensed feature.

## License Keys Overview

**Table 5** provides a brief summary on the types of licensed features available for the MC1-UHD.

**Table 5 List of MC1-UHD Licensed Features**

License	Description
MC1-UHD-12G-LICENSE	Enables the use of UHD 12Gbps SDI signaling on the card
MC1-UHD-DVE-1CH-LICENSE	Enables the use of a single channel of 2D DVE <sup>a</sup>
MC1-UHD-MASTERCTRL-LICENSE	Enables a single channel of Master Control

a. The MC1-UHD has 1.5GB of DDR playout memory when the MC1-UHD-DVE-1CH-LICENSE license is enabled.

## Installing a License Key

Ross Video uses license keys to control user access to specific MC1-UHD features. You can obtain a key for a MC1-UHD licensed feature from Ross Video Technical Support.

### To install a license key

1. Display the Global interface as outlined in **“To display the Global interface in DashBoard”**.
2. Select the **Configure Licenses** tab.
3. Make a note of the character string in the **Request Code** field for the feature you wish to enable.
4. Contact Ross Video using the information found in the section **“Contacting Technical Support”**.
  - a. When you speak to your Technical Support representative, tell them your name, your facility name, and the **Request Code** from the **Configure Licenses** tab.
  - b. You will be given a License Key that must be entered in the applicable field in the **Licenses** table.
5. Enter the provided License Key in the applicable **Key** field in the **Configure Licenses** tab.
6. Click **Apply** in the row for the License Key you entered in step 5.

## Removing a License Key

Disabling a License Key removes user access to the MC1-UHD features associated with that License Key.

- ★ To re-enable the features, you will need to contact Ross Technical Support and request a new License Key.

### To remove a license key

1. Display the Global interface as outlined in “**To display the Global interface in DashBoard**”.
2. Select the **Configure Licenses** tab.
3. Click in the **Key** field for the licensed feature you want to remove.
4. Type `remove`.
5. Click **Apply** to remove the license.

# Reference and Video Format Setup

The OGX-FR frame supports a distributed frame reference, allowing incoming reference signals to feed timing information to all openGear cards in that frame. Thus, a single signal can be used for multiple cards.

## Specifying a Global Reference Source

★ When using a progressive format reference signal to lock an interlaced format video signal, the lock will be Frame Locked but Field indeterminate.

## Frame Rate Compatibility

The card allows you to use any interlaced video format to operate the card in any format of the same frequency; however, the use of 480i or 576i (Composite Sync) reference signals for High Definition (720p, 1080i, 1080p) or UHD (2160p) video formats is not recommended for optimal performance.

The use of composite sync reference formats is recommended for Standard Definition video modes only, and provides stable outputs with jitter performance in compliance with **SMPTE-259M** specifications.

**Table 6** outlines the MC1-UHD frame rate compatibility.

**Table 6 Output/Reference Compatibility**

Video Format	Reference Format							
	480i 59.94	1080i 59.94Hz	720p 59.94Hz	576i 50Hz	1080i 50Hz	720p 50Hz	1080pSF 23.98Hz	1080pSF 24Hz
480i 59.94Hz	✓	✓	✓					
720p 59.94Hz	✓	✓	✓					
1080i 59.94Hz	✓	✓	O					
1080p 59.94Hz	✓	✓	✓					
576i 50Hz				✓	✓	✓		
720p 50Hz				✓	✓	✓		
1080i 50Hz				✓	✓	O		
1080p 50Hz				✓	✓	✓		
1080pSF 23.98Hz							✓	✓
1080pSF 24Hz							✓	✓
2160p <sup>a</sup> 50Hz				✓	✓	✓		
2160p <sup>a</sup> 59.94Hz	✓	✓	✓					

a.Requires the MC1-UHD-12G-LICENSE.

O = field indeterminate

### For More Information on...

- the options in the Analog Reference Status menu, refer to **Table 25**.

### To specify a global analog reference source for the MC1-UHD

1. Navigate to the **Global** interface as outlined in “**To display the Global interface in DashBoard**”.
2. Select the **Setup** tab.

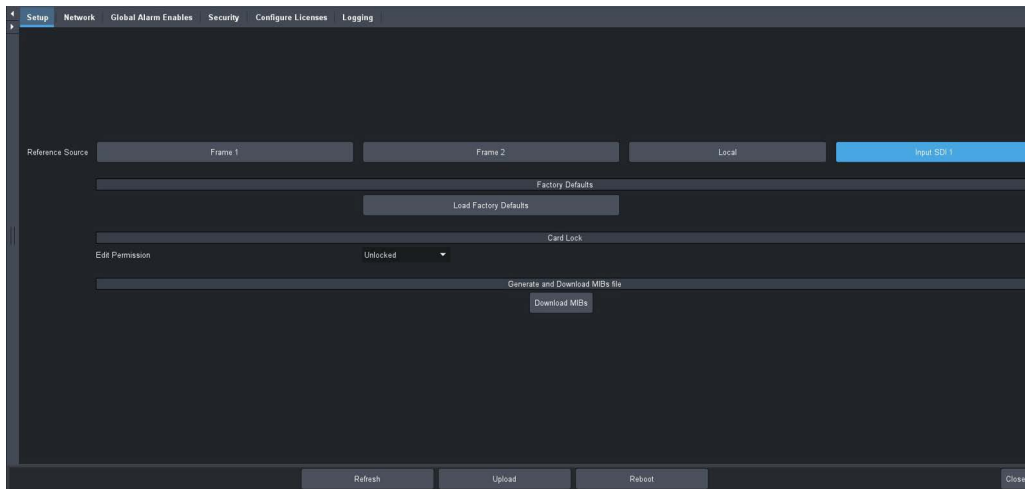

3. Use the **Analog Reference Source** options to specify the source for the reference input signal. Choose from the following:
    - **Frame 1** — assigns the source connected to the **REF 1** port on the openGear frame.
    - **Frame 2** — assigns the source connected to the **REF 2** port on the openGear frame.
    - **Local** — assigns the external reference source connected to **REF IN** port on the rear module.
    - **Input SDI 1** — assigns the signal connected to the **SDI IN 1** port on the rear module.
- ★ Ensure the input video frame rate matches the reference frame rate.

## Monitoring the Reference Signal via DashBoard

The status of the MC1-UHD may be monitored via its fields in the DashBoard client software.

### To configure the reference alarm for the MC1-UHD

1. Navigate to the **Global** interface as outlined in “**To display the Global interface in DashBoard**”.
2. Select the **Global Alarm Enables** tab.
3. Select the **Alarm Enable** box in the Reference Format row of the tab to enable the Card state status field, located in the top left corner of the Global interface, to report when the analog reference signal is not detected.

## Specifying the Video Format

When setting the card output video format, ensure to that all SDI inputs match the specified format.

### For More Information on...

- the options in the Output Format menu, refer to **Table 31**.

## To specify the output video format

1. Navigate to the **Configuration** interface as outlined in **“To display the Configuration interface in Dashboard”**.
2. Select the **Video Format** tab.

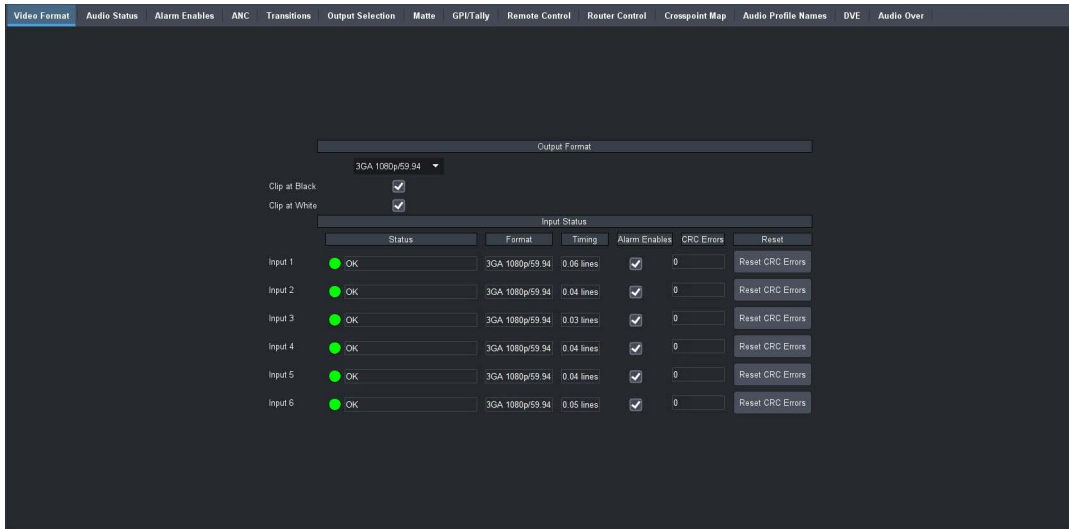

3. Use the **Format** menu, located in the Output Format area of the tab, to specify the card output video format.
- ★ Ensure that the specified output format matches the input video format.
4. Select the **Clip at Black** to enable the MC1-UHD to clip at 0x40 on all outputs.
  5. Select the **Clip at White** box to enable the MC1-UHD to clip at 0x3AC on all outputs.

## Configuring the Time Source

The Frame Network Controller card in the openGear frame can use an NTP server as a time source. The time data is then made available to any openGear card installed in the same frame. You must manually enable the MC1-UHD to access this time data by selecting an option on its Global > Network tab.

### For More Information on...

- setting up the Frame Network Controller to communicate with an NTP server, refer to the ***MFC-OG3-N and MFC-8322-S User Manual***.

### To enable the MC1-UHD to access the time data from the Frame Network Controller card

1. Navigate to the **Global** interface as outlined in **“To display the Global interface in Dashboard”**.
2. Select the **Network** tab.
3. Locate the **Network Time** area of the tab.
4. Select the **Use time from Frame Controller** box.
5. Click **Apply**.

### To enable monitoring of the time data

1. From the **Global** interface, select the **Global Alarm Enables** tab.
2. Locate the **Network Alarm** area of the tab.

3. Select the **Alarm Enable** check box.

The **Network time** field will report the status of the time data.



# Configuring the Outputs

This chapter provides instructions for setting the card output video format.

## Before You Begin

Keep the following in mind when configuring your SDI signals:

- The SDI output timing is fixed on the MC1-UHD and is set to approximately 0.5 lines after the reference.
- Each video input has a line sync that can support a full line of HD video including horizontal blanking.
- All video inputs must be timed with the reference. The input tolerance is approximately +/- 0.5 line. Exceeding this tolerance will result in the output shifting of 1 line. The status fields in the Configuration > Video Format tab displays a Yellow indicator when operating outside the range of the line sync. In such cases, a vertical shift of 1 line or more may occur.
- All of the video inputs must be the same video format as specified in the Configuration > Video Format tab in DashBoard. If the formats do not match, the card reports an error in the DashBoard Signal Status area and on the card-edge LEDs.

## Specifying the Outputs

Each of the six SDI outputs (on the rear module) can be configured as Program, Preview, one of four Clean Feeds, or a Logo channel.

### To configure your video outputs

1. Navigate to the **Configuration** interface as outlined in **“To display the Configuration interface in DashBoard”**.
2. Select the **Output Selection** tab.
3. Use the **Output** (1-6) menus to specify the signal to assign to a specific SDI output. Choose from the following:
  - **Black** — the specified output displays black.
  - **Program** — the specified output displays the Program output.
  - **Preview** — the specified output displays the Preview output.
  - **Clean #** — the specified output displays the selected clean feed output.
  - **Logo #** — the specified logo channel to the output.



# Router Setup

The Ross Ultrix router and third-party routers communicate with the MC1-UHD using the GVG Series 7000 Ethernet protocol. This chapter provides instructions for the basic physical installation and communications setup of your Ultrix router to the MC1-UHD. Note that your facility requirements may differ from what is presented.

★ Router control requires an MC1-UHD-MASTERCTRL-LICENSE. Refer to “**Licensed Features**”.

**For More Information on...**

- setting up your router, refer to the *Ultrix User Guide*.

## Ultrix Setup Overview

Before proceeding, ensure the Ultrix router:

- is set up for third-party communications by referring to the *Ultrix User Guide*
- is connected to your facility network and displays in the Tree View of your DashBoard client
- is running the following software versions

**Table 7 Recommended Software Versions**

Product	Min. Software Version
Ultrix router	v4.0
Ultrix Core Central Controller (optional)	v4.0

**Figure 14** illustrates the physical connections in a routing system that includes an Ultrix and an MC1-UHD. Ross Video does not supply these cables.

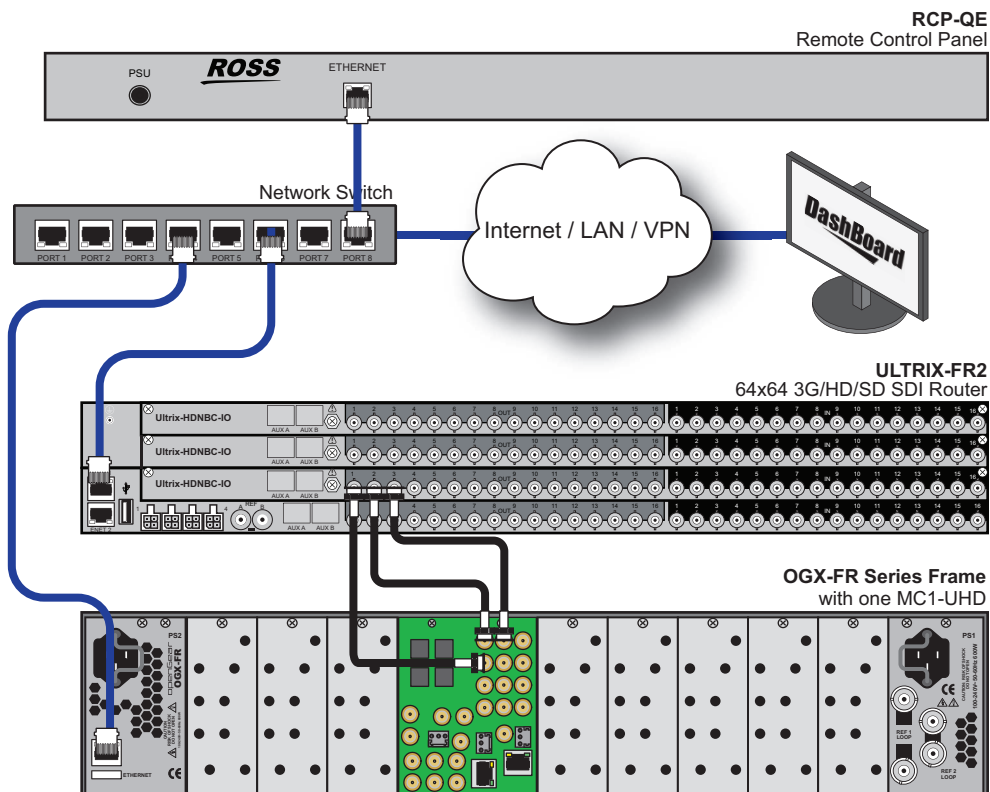

*Figure 14 Routing System Work Flow with a Ross Ultrix Router and an MC1-UHD*

## Communications Setup

This section outlines how to configure the MC1-UHD to communicate with the Ultrix router via the GVG Series 7000 Ethernet protocol.

Before proceeding, ensure that:

- the router is set up for ethernet communications by referring to its user manual.
- the license key for router control is installed on the MC1-UHD. Refer to “**Licensed Features**”.

**For More Information on...**

- the **Remote Control** tab, refer to “**Remote Control Tab**”.
- the **Router Control** tab, refer to “**Router Control Tab**”.
- specifying a delay or a retry value, refer to “**Specifying the Router Switch Retries**”.

**To specify the GVG Series 7000 protocol for the MC1-UHD**

1. Navigate to the **Configuration** interface as outlined in “**To display the Configuration interface in DashBoard**”.
2. Select the **Remote Control** tab.
3. Locate the **Ultrix Router (GVG Series 7000)** area of the tab.
4. Select the box in the **Ultrix Router (GVG Series 7000)** area.
5. From the **Connection** menu, select **Network Client**.
6. Click **Network Setup**.

The **Configure the Network Connection** dialog opens.

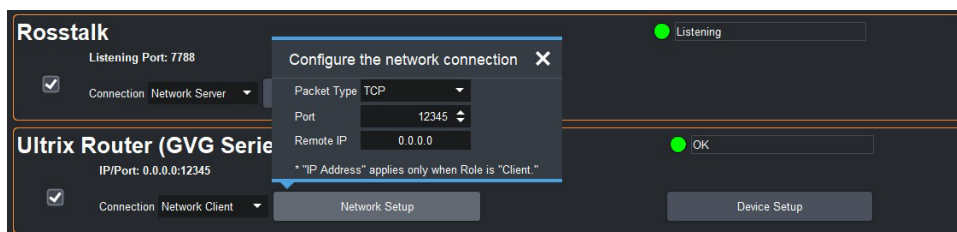

7. From the **Packet Type** menu, select **TCP**.
8. From the **Port** menu, specify the port number of the router.
- ★ The default port number is 12345 for the Ultrix router.
9. From the **Remote IP** menu, specify the IP address of the router.
10. Close the **Configure the Network Connection** dialog.

The new settings are automatically applied.

**To define the communication options to the router**

1. In the **Ultrix Router (GVG Series 7000)** area, click **Device Setup**.  
The **GVG Series 7000 Native Setup** dialog opens.

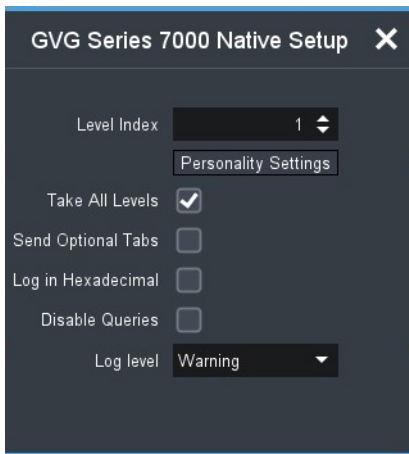

2. Use the **Level Index** field to specify the level that the router will perform crosspoint switches on.
3. Select the **Take All Levels** box to enable all transitions to take effect on all router levels.
- ★ When using an Ultrix router, leave the **Send Optional Tabs** box unselected (no check-mark).
4. Use the **Log Level** options to specify what type of messages are in the log report.
5. If the **SEND** and **RECV Enable Log Messages** boxes were selected in step 4, select the **Log in Hexadecimal** box to display these log messages in hexadecimal.
6. If you are connecting to an NV9000, select the **Disable Queries** box.
7. Close the **GVG Series 7000 Native Setup** dialog.

The new settings are automatically applied.

#### To verify a connection on the Ultrix router

1. Display the Connections tab for the Ultrix router as follows:
    - a. Locate the Ultrix in the Tree View of DashBoard.
    - b. Expand the Ultrix node to display a list of sub-nodes in the Tree View.
    - c. Expand the Database sub-node.
    - d. Select the Connections sub-node.
    - e. Double-click the Connections node to display the Connections tab.
  2. Locate the MC1-UHD in the Connections table.
- ★ After reboot, the MC1-UHD will check the router status and report the current router connection status on the On Air Control interface.

## Third-Party Router Setup

When setting up communication between the MC1-UHD and a third-party router, optional licenses and/or protocol translator hardware may be required to enable GVG Series 7000 Native protocol on your router. Refer to your router documentation to configure a remote interface.

Refer to **“Ultrix Setup Overview”** to learn how to setup the MC1-UHD to communicate via the GVG Series 7000 Native protocol.

## Specifying the Router Switch Retries

The MC1-UHD provides options for delaying transitions to wait for the router switch to complete. You can also specify a re-try value when the router switch has not completed within a specified length of time. Once the maximum number of re-tries is reached, the MC1-UHD pushes back the crosspoints to the previous state.

### To configure the router switch command retries

1. Navigate to the **Configuration** interface as outlined in “**To display the Configuration interface in DashBoard**”.
2. Select the **Router Control** tab.
- ★ The measured min / max response time is displayed on this tab. It can be used as a good starting point in specifying the Minimum Delay vlaue.
3. Use the **Minimum Delay** slider to specify the number of frames the MC1-UHD waits between sending the next switch command to the router.
4. Use the **Retry Interval** slider to specify the number of frames the MC1-UHD waits before re-sending the same switch command to the router.
5. Use the **Max Retries** slider to specify the maximum number of times the MC1-UHD will send the same switch command to the router before the switch is abandoned and an error condition is raised.

### For More Information on...

- the read-only fields in the **Router Control** tab, refer to “**Router Control Tab**”.

## Assigning a Router Output to an SDI Input on the MC1-UHD

### To assign a router output to an SDI input on the MC1-UHD

1. Navigate to the **Configuration** interface as outlined in “**To display the Configuration interface in DashBoard**”.
2. Select the **Router Control** tab.
3. Locate the row for the SDI input you want to assign to the router output.
4. Use the menu in the **Destination** column for the SDI row, to assign a router destination to an SDI input.

## Using Parked Sources

If your routing system is using resource management, assigning a Parked Source will allow the user to disconnect the current destination (switch the same source number to the destination). The specified output is parked when the crosspoint selected was not a router source.

### To assign a parked source

1. Navigate to the **Configuration** interface as outlined in “**To display the Configuration interface in DashBoard**”.
  2. Select the **Router Control** tab.
  3. Locate the row for the SDI input you want to specify the parked source.
  4. Use the menu in the **Parked Source** column for the SDI row, to specify the source to use when the router destination is parked.
- ★ It is recommended to select a Parked Source with the same video format as the program video.

# Crosspoint Mapping

This chapter outlines how to specify the number of available crosspoints, and assign sources to each crosspoint.

## For More Information on...

- the menu items in the **Crosspoint Map** tab, refer to **Table 49**.

## Default Crosspoint Mapping

The MC1-UHD is shipped with a factory default mapping for the available inputs to the crosspoint buttons on the DashBoard control panel. However, you can also change the sources assigned to the router destinations that are associated with the MC1-UHD using the options in the **Crosspoint Map** tab.

**Table 8** outlines the default crosspoint mapping for the MC1-UHD.

**Table 8 Default Crosspoint Mapping**

Crosspoint Button	Unshifted		Shifted	
	Source Type	Selection	Source Type	Selection
1	Black		Matte	Black
2	Matte	Matte 1	Router	Source 5
3	Matte	Matte 2	Router	Source 6
4	SDI Input	SDI 1	Router	Source 7
5	SDI Input	SDI 2	Router	Source 8
6	SDI Input	SDI 3	Router	Source 9
7	SDI Input	SDI 4	Router	Source 10
8	SDI Input	SDI 5	Router	Source 11
9	SDI Input	SDI 6	Router	Source 12
10	Logo	Logo 1	Router	Source 13
11	Logo	Logo 2	Router	Source 14
12	Router	Source 1	Router	RTR Extra 1
13	Router	Source 2	Router	RTR Extra 2
14	Router	Source 3	Logo	Logo 3
15	Router	Source 4	Logo	Logo 4
16	SHIFT	SHIFT	SHIFT	SHIFT

## Specifying the Number of Available Crosspoints

By default, the Program and Preset buses include 16 buttons each. You can change the number of buttons per bus as required.

- ★ This number is in addition to the **Shift** button.

## To specify the number of available crosspoints

1. Navigate to the **Configuration** interface as outlined in **“To display the Configuration interface in DashBoard”**.
2. Select the **Crosspoint Map** tab.

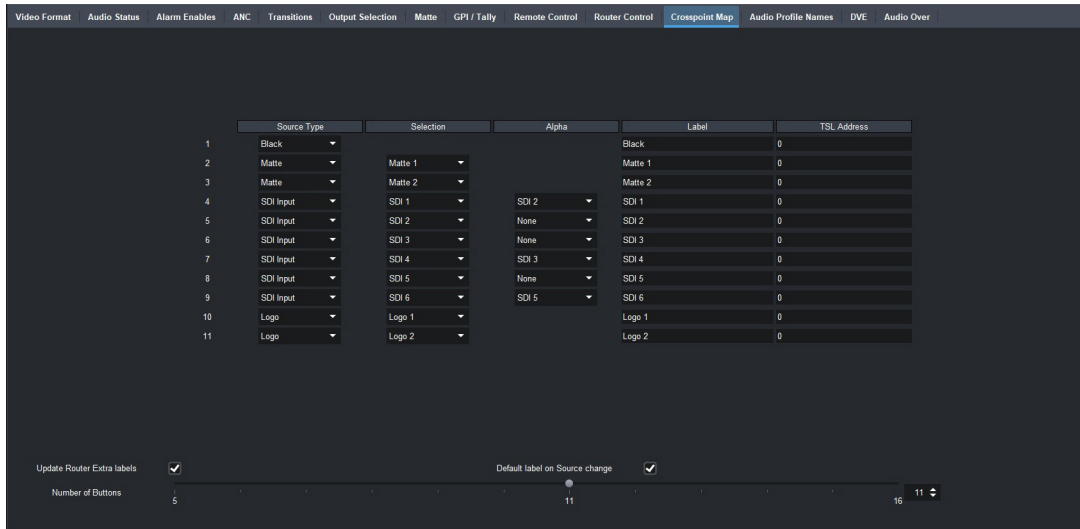

3. Use the **Number of Buttons** slider to specify the number of crosspoint buttons to display in the Active Channel On Air Control interface.

## Mapping the Program and Preset Crosspoints

Each crosspoint button can have two inputs assigned: the video source and an optional alpha source. The alpha source is used only when selecting an external key.

- ★ If you change the Alpha assigned to a crosspoint already selected on an External Key, you will also need to send another router request (navigate to the On Air Control > External Keys tab, select another crosspoint on the External Key bus and then select the re-configured crosspoint).

### For More Information on...

- assigning the Router Extra function for Automation control, refer to **“Reserving Crosspoints for Automation Use”**.

### To map a matte generator to a crosspoint

1. Navigate to the **Configuration** interface as outlined in **“To display the Configuration interface in DashBoard”**.
2. Select the **Crosspoint Map** tab.
3. Locate the row for the router button you wish to map.
4. Use the **Source Type** menu to select **Matte**.
5. Use the **Selection** menu to assign a specific matte generator.
6. Use the **Label** field to specify the text that will display on the button.
7. Proceed to the chapter **“Mattes”** to set up the matte generators for the MC1-UHD.

### To map an SDI input to a crosspoint

1. Navigate to the **Configuration** interface as outlined in **“To display the Configuration interface in DashBoard”**.
2. Select the **Crosspoint Map** tab.



3. Use the **Source Type** menu to select **SDI Input**.
4. Use the **Selection** menu to assign one of the SDI inputs available on the MC1-UHD rear module.
5. Use the **Alpha** menu to assign a source for the alpha channel of the crosspoint.
6. Use the **Label** field to specify the text that will display on the button.

#### **To map a router source to a crosspoint**

1. Navigate to the **Configuration** interface as outlined in **“To display the Configuration interface in DashBoard”**.
2. Select the **Crosspoint Map** tab.
3. Locate the row for the router source you wish to map.
4. Use the **Source Type** menu to select **Router**.
5. Use the **Selection** menu to assign a router source to the button.
6. Use the **Alpha** menu to assign a source for the alpha channel of the crosspoint.
7. Use the **Label** field to specify the text that will display on the button.

★ Leave the Label field to its default value to use the auto-populated labels supplied by the router.

#### **To map a logo channel to a crosspoint**

1. Navigate to the **Configuration** interface as outlined in **“To display the Configuration interface in DashBoard”**.
2. Select the **Crosspoint Map** tab.
3. Locate the row for the button you wish to map.
4. Use the **Source Type** menu to **Logo**.
5. Use the **Selection** menu to assign a specific logo channel.
6. Use the **Label** field to specify the text that will display on the button.
7. Proceed to the chapter **“Media File Management”** to set up the logo channels for the MC1-UHD.



# Using RossTalk

The MC1-UHD can be controlled from a remote editor or computer via RossTalk commands. These commands can be sent to the MC1-UHD over an Ethernet or Serial connection.

## Using an Ethernet Connection

Contact your IT Department before connecting to your facility network to ensure that there are no conflicts. They will provide you with an appropriate value for the IP Address, Subnet Mask, and Gateway for the external device communicating with the MC1-UHD.

## Cabling Requirements

You will require a standard network CAT-5 cable to connect the MC1-UHD to your facility network. Refer to “**Cabling the Ethernet Port on the OGX-FR Frame**” for more information.

## Configuring the MC1-UHD for RossTalk Communications

This section outlines how to configure the MC1-UHD to communicate with a device via RossTalk.

### For More Information on...

- the RossTalk settings on the Remote Control tab, refer to **Table 42**.

### To enable the RossTalk protocol for Ethernet communications

1. Navigate to the **Configuration** interface as outlined in “**To display the Configuration interface in DashBoard**”.
2. Select the **Remote Control** tab.
3. Locate the **RossTalk** area in the tab.
4. Select the box in the **RossTalk** area.
5. From the **Connection** menu, select one of the following:
  - **Network Client** — The MC1-UHD functions as a service requester that initiates communications with a server on the network.
  - **Network Server** — The MC1-UHD functions as a host, or socket listener, on the network. This is the default.
6. Click **Network Setup**.  
The **Network Setup** dialog opens.
7. Use the **Packet Type** menu to specify the Ethernet protocol your external device will use to communicate with the MC1-UHD.
8. Ensure the **Port** field is set to **7788**.
9. If you selected **Network Client** in step 5, use the **Remote IP** field to specify the IP Address of the MC1-UHD on the network to be used for RossTalk communications.
10. Close the **Network Setup** dialog.

The new settings are automatically applied.

## Using a Serial Connection

RossTalk commands can be sent to the MC1-UHD via the **SERIAL** a serial port (RS-232/RS-422) on the card's rear module.

★ Refer to the documentation for your external device for specific cabling requirements.

## Cabling Requirements

Refer to “**Serial Cabling**” for details on connecting a serial device to the MC1-UHD rear module.

## Configuring the MC1-UHD for Serial RossTalk Communications

This section outlines how to configure the MC1-UHD to communicate with a device via RossTalk.

### To enable the RossTalk protocol for serial communications

1. Navigate to the **Configuration** interface as outlined in “**To display the Configuration interface in DashBoard**”.
2. Select the **Remote Control** tab.
3. Locate the **RossTalk** row in the tab.
4. Select the box in the **RossTalk** area.
5. From the **Connection** menu, select **Serial Port**.
6. Click **Serial Port Setup**.

The **Configure the serial connection** dialog opens.

7. Use the **Port Type** menu to specify transmission standard the external device uses. The default is RS 422.
8. Use the **Bit rate** menu to select the bit rate for the external device connected to the Serial port of the MC1-UHD. The default is 115200.
9. Use the **Data Bits** menu to set the number of data bits transmission (character length). The default is 8.
10. Use the **Parity** menu to set the parity type for the external device. The default is None.
11. Use the **Stop Bits** menu to set the number of stop bits transmission. The default is 1.
12. Use the **Flow Control** menu to enable the MC1-UHD notify the serial device when it is experiencing a data overflow and stop sending data (SW) or to allow continuous data flow between the MC1-UHD and the device (None). The default is None.
13. Close the **Configure the serial connection** dialog.

The new settings are automatically applied.

## Using the RossTalk Protocol

RossTalk is a plain text based protocol that allows control of Ross Video equipment.

### Sending RossTalk Commands

RossTalk commands are generally case-sensitive, and must be terminated with carriage return and linefeed (CR+LF). When using with the MC1-UHD, the command can be uppercase or lowercase, and the terminator can be simply linefeed.

For example,

```
MSPATH 1:0:ColorRamp.tga
MSPATH 1:0:directory/filename.png
```

## To send RossTalk Commands

1. Verify that you have created a network connection to the MC1-UHD.
2. Enter the commands you want to send to the MC1-UHD.

## Supported RossTalk Commands

**Table 9** lists the RossTalk commands that the MC1-UHD supports.

**Table 9 Supported RossTalk Commands**

Command	Description
<b>FTB</b>	Performs a fade-to-black transition
<b>FTB level</b>	<ul style="list-style-type: none"> <li>• Level 0 = always clears FTB. No impact if already FTB.</li> <li>• Level 1 = always sets FTB state.</li> </ul>
<b>GPI xx</b>	Triggers action associated with the specified GPI number (xx)
<b>GPI xx:level</b>	Triggers GPI number xx where: <ul style="list-style-type: none"> <li>• Level 0 = logically OFF</li> <li>• Level 1 = logically ON</li> </ul>
<b>KEYAUTO 1:keyer</b>	Fades a key on/off air. The keyer value is 1 to 6.
<b>KEYAUTO 1:keyer:level</b>	<ul style="list-style-type: none"> <li>• Level 0 = always take key off air; no change if key is already off air</li> <li>• Level 1 = always take key on air; no change if key is already on air</li> </ul>
<b>KEYCUT 1:keyer</b>	Cuts a key on/off air. The keyer value is 1 to 4.
<b>KEYCUT 1:keyer:level</b>	<ul style="list-style-type: none"> <li>• Level 0 = always take key off air; no change if key is already off air</li> <li>• Level 1 = always take key on air; no change if key is already on air</li> </ul>
<b>MSPATH CHAN:0:FILENAME</b>	<p>Load a still or animation from the Micro SD card where:</p> <ul style="list-style-type: none"> <li>• <b>CHAN</b> is logo channel (1 to 2)</li> <li>• <b>FILENAME</b> is the directory/filename to be loaded. There is a maximum filename length of 256bytes.</li> </ul> <p>★ While the <b>FILENAME</b> does not need to be complete, it still requires enough characters to uniquely identify the file in the directory.</p>
<b>VGPIARM</b>	<ul style="list-style-type: none"> <li>• Supports a maximum of sixteen VGPIs (VGPI 0 to VGPI 17)</li> <li>• This command will be ignored when the specified SqueezeBack Preset is on Program</li> <li>• When in Arm Up state, the command includes the specified SqueezeBack Preset in the transition (the <b>SQUEEZE</b> button is lit on the On Air Control interface)</li> <li>• When in Arm down/Disarm state, the command excludes the specified SqueezeBack Preset in the transition (the <b>SQUEEZE</b> button is unlit on the On Air Control interface)</li> </ul>

Command	Description
<b>VGPISTATE</b>	<ul style="list-style-type: none"><li>• When no SqueezeBack Preset is on Program and this command is in the Up state, selects the effect type of VGPI and transitions the selected effect on Program.</li><li>• When a SqueezeBack Preset is on Program and this command is in the Down state, the VGPI which has the same effect as the current one will be handled and the current effect will be off air or on Preview.</li><li>• In other cases, the command will be ignored.</li></ul>

# Comtrol® DeviceMaster® Setup

The Comtrol® DeviceMaster® connects to the MC1-UHD over ethernet and provides a number of RS-232/422/485 serial ports. This chapter describes how to set up the MC1-UHD and the DeviceMaster to work together.

## Cabling Requirements

You will need a Comtrol® DeviceMaster® Port Expander, and Ethernet interface cables. Refer to **Table 10** for pin-outs on the Port Expander.

**Table 10 Pinouts on the Port Expander**

Pin	RS-232	RS-422
1	CD	n/c
2	Rx	RxA (Rx-)
3	Tx	TxA (Tx-)
4	DTR	n/c
5	Ground	n/c
6	DSR	n/c
7	RTS	TxB (Tx+)
8	CTS	RxB (Rx+)
9	RI	n/c

## DeviceMaster Setup

This procedure assumes that a DeviceMaster is already installed in your facility. If not, or if you are encountering difficulties configuring your DeviceMaster via a web browser, it is recommended to use the Comtrol® PortVision® software to set up your DeviceMaster. Refer to your DeviceMaster documentation for details on using this software or for troubleshooting your installation.

### To set up a DeviceMaster

1. On your computer:
  - a. Open your web browser
  - b. In the address bar, enter the IP address of your DeviceMaster.
    - ★ The default address is 192.168.250.250.
  - c. Press **Enter**.
2. Click **Configure Network**.
3. Click **Use static configuration below:** and enter the IP Address, Netmask, and Gateway you want to use.
  - ★ A static IP Address is recommended for the DeviceMaster to communicate with the MC1-UHD
4. Click **Save**.

Changes do not take effect until the DeviceMaster is rebooted.

5. Click **Port x**, where **x** is the port on the DeviceMaster you are connecting a device to.
6. Enter the Serial Configuration information for your device.
7. Enter the TCP Connection Configuration information for your device:
  - **Enable** — selected
  - **Listen** — selected
  - **Port** — Ross Video suggests that you start numbering the ports at 8701.
  - Leave all other settings at their default values.
8. Click **Save**.

Changes do not take effect until the DeviceMaster is rebooted.

9. Reboot the DeviceMaster.

## MC1-UHD Setup

This section outlines how to configure the MC1-UHD to communicate with the Control® DeviceMaster® via an ethernet protocol. In this section, we use the Presmaster protocol as an example.

### To set up communications

1. Navigate to the **Configuration** interface for the MC1-UHD as outlined in **“To display the Configuration interface in Dashboard”**.
2. Select the **Remote Control** tab.
3. Locate the **Presmaster Control** area of the tab.
4. Select the box in the **Presmaster Control** area.
5. From the **Connection** menu, select **Network Client**.

The MC1-UHD will function as a service requester that initiates communications with a server on the network

6. Click **Network Setup**.

The **Network Setup** dialog opens.
7. From the **Packet Type** menu, select **TCP**.
8. Use the **Port** field to specify the port number for the DeviceMaster.
9. Use the **Remote IP** field to specify the IP Address of the DeviceMaster on the network to be used for communications.
10. Close the **Network Setup** dialog.

The new settings are automatically applied.



# Using TSL UMD v3.1 Protocol

A third-party router, Multiviewer, or Ultrix router can communicate with the MC1-UHD via the Tally Systems Ltd. Under Monitor Display (TSL UMD) v3.1 protocol over a serial or ethernet connection.

★ TSL UMD control requires the MC1-UHD-MASTERCTRL-LICENSE. Refer to “**Licensed Features**”.

## For More Information on...

- the specific cabling requirements of your external device, refer to the user documentation for your device.

## Using a Serial Connection

The external device connects to the MC1-UHD via the **SERIAL** port on the MC1-UHD rear module. Ross Video does not supply this cable.

## For More Information on...

- the pinouts for the **SERIAL** port, refer to “**Serial Port Specifications**”.

## Configuring the MC1-UHD for Serial TSL UMD Communications

This section outlines how to configure the MC1-UHD to communicate with a device via a serial connection and the TSL UMD v3.1 protocol.

### To configure the MC1-UHD for serial TSL UMD v3.1 communications

1. Navigate to the **Configuration** interface as outlined in “**To display the Configuration interface in Dashboard**”.
2. Select the **Remote Control** tab.
3. Locate the **Tally Protocol Control** area in the tab.

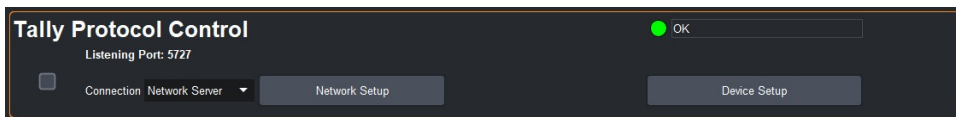

4. Select the box in the **Tally Protocol Control** area.
5. From the **Connection** menu, select **Serial Port**.
6. Click **Serial Port Setup**.  
The **Configure the serial connection** dialog opens.
7. Use the **Port Type** menu to specify transmission standard the external device uses. The default is RS 422.
8. Use the **Bit rate** menu to select the bit rate for the external device connected to the Serial port of the MC1-UHD. The default is 115200.
9. Use the **Data Bits** menu to set the number of data bits transmission (character length). The default is 8.
10. Use the **Parity** menu to set the parity type for the external device. The default is None.
11. Use the **Stop Bits** menu to set the number of stop bits transmission. The default is 1.
12. Use the **Flow Control** menu to enable the MC1-UHD notify the serial device when it is experiencing a data overflow and stop sending data (SW) or to allow continuous data flow between the MC1-UHD and the device (None). The default is None.

13. Close the **Configure the serial connection** dialog.

The new settings are automatically applied.

## Using an Ethernet Connection

Contact your IT Department before connecting to your facility network to ensure that there are no conflicts. They will provide you with an appropriate value for the IP Address, Subnet Mask, and Gateway for the MC1-UHD and your external device.

### Cabling Requirements

You will require a standard network CAT-5 cable to connect the MC1-UHD to your facility network. Refer to “**Cabling the Ethernet Port on the OGX-FR Frame**” for more information. Ross Video does not supply this cable.

### Configuring the MC1-UHD for Ethernet TSL UMD Communications

This section outlines how to configure the MC1-UHD to communicate with an external device via an Ethernet connection and the TSL UMD v3.1 protocol.

#### To enable the TSL UMD v3.1 protocol for ethernet communications

1. Navigate to the **Configuration** interface as outlined in “**To display the Configuration interface in DashBoard**”.
2. Select the **Remote Control** tab.
3. Locate the **Tally Protocol Control** area in the tab.
4. Select the box in the **Tally Protocol Control** area.
5. From the **Connection** menu, select **Network Client**.

The MC1-UHD functions as a service requester that initiates communications with a server on the network.

6. Click **Network Setup**.

The **Network Setup** dialog opens.

7. Use the **Packet Type** menu to specify the Ethernet protocol your external device will use to communicate with the MC1-UHD.
8. Ensure the **Port** field is set to **7788**.
9. If you selected **Network Client** in step 5, use the **Remote IP** field to specify the IP Address of the MC1-UHD on the network to be used for RossTalk communications.
10. Close the **Network Setup** dialog.

The new settings are automatically applied.

### Tally Label Settings

Tally label text is determined by the external device (the source of the tally). Refer to “**Crosspoint Mapping**” for information on router crosspoint mapping and label definition.

### Protocol Implementation

MC1-UHD implements the protocol with the following structure: `DisplayID|Control|DisplayData`.

**Table 11** lists the TSL UMD Protocol v3.1 commands the MC1-UHD supports.

**Table 11 TSL UMD Protocol v3.1 Commands**

<b>Command</b>	<b>Description</b>
Display Address	0 - 126 display identification enumeration
<b>Control Byte</b>	
Bit 0	Tally 1 status (1=on, 0=off)
Bit 1	Tally 2 status
Bit 2	Tally 3 status
Bit 3	Tally 4 status
Bits 4-5	Brightness value
Bit 6	Reserved
Bit 7	0
Display Data	16 ASCII display characters (20h-3Eh)



# Using the Presmaster Protocol

The MC1-UHD supports a subset of Miranda™ Presmaster Control System automation commands and automation tallies. This chapter outlines how to setup communications with a third-party device using the Presmaster protocol.

## For More Information on...

- the Miranda™ Presmaster protocol, refer to the *Miranda Presmaster Automation Protocol Manual*.
- configuring a Control DeviceMaster, refer to “**Control® DeviceMaster® Setup**”.
- the location of the **ATMN** button on the **On Air Control** interface, refer to “**Menu System Basics**”.

## Configuring an Ethernet Connection for Presmaster

Before you proceed, ensure that the MC1-UHD is connected to your facility network and assigned a valid IP Address.

## For More Information on...

- network cabling requirements, refer to “**Cabling the Ethernet Port on the OGX-FR Frame**”.
- assigning an IP Address, refer to “**Configuring the Initial Network Settings**”.

## Configuring the MC1-UHD for Ethernet Presmaster Communications

This section outlines how to configure the MC1-UHD to communicate with the Presmaster Ethernet protocol.

### To enable the Presmaster protocol for ethernet communications

1. Navigate to the **Configuration** interface as outlined in “**To display the Configuration interface in Dashboard**”.
  2. Select the **Remote Control** tab.
  3. Locate the **Presmaster Control** area of the tab.
  4. Select the box in the **Presmaster Control** area.
  5. From the **Connection** menu, select one of the following:
    - **Network Client** — The MC1-UHD functions as a service requester that initiates communications with a server on the network.
    - **Network Server** — The MC1-UHD functions as a host, or socket listener, on the network. This is the default.
  6. Click **Network Setup**.  
The **Network Setup** dialog opens.
  7. Use the **Packet Type** menu to specify the Ethernet protocol your external device will use to communicate with the MC1-UHD. The default is TCP.
  8. Use the **Port** field to specify the port that the MC1-UHD will listen on. The default is 9001.
  9. If you selected **Network Client** in step 5, use the **Remote IP** field to specify the IP Address of the MC1-UHD on the network to be used for Presmaster communications.
- ★ The **Remote IP** field value is ignored when the **Connection** is set to **Network Server**.
10. Close the **Network Setup** dialog.

The new settings are automatically applied.

## Configuring a Serial Connection for Presmaster

Presmaster commands can be sent to the MC1-UHD via the **SERIAL** port (RS-232/RS-422) on the card's rear module.

★ Refer to the documentation for your external device for specific cabling requirements.

### Cabling Requirements

Refer to “**Serial Cabling**” for details on connecting a serial device to the MC1-UHD rear module.

### Configuring the MC1-UHD for Serial Presmaster Communications

This section outlines how to configure the MC1-UHD to communicate with the Presmaster Serial protocol.

#### To enable the Presmaster protocol for Serial communications

1. From the Tree View in DashBoard, expand the node for the MC1-UHD you want to access.
2. Select the **Configuration** node to display the interface in the right-half of DashBoard.
3. Select the **Remote Control** tab.
4. Locate the **Presmaster Control** area of the tab.
5. Select the box in the **Presmaster Control** area.
6. From the **Connection** menu, select **Serial Port**.
7. Click **Serial Port Setup**.

The **Configure the serial connection** dialog opens.

8. Select the electrical standard from the **Port Type** menu. This must match the serial cable type that connects the MC1-UHD to the external serial device.

★ The Bit Rate, Data Bits, Parity, and Stop Bits values are reset to their default values when a different type is selected.

9. Use **Table 12** to set the required parameters for the Presmaster.

**Table 12 Setup Parameters**

Parameter	Setting
Bit Rate	38400
Data Bit	8
Parity	Even
Stop Bit	1

10. Use the **Flow Control** menu to enable the MC1-UHD notify the serial device when it is experiencing a data overflow and stop sending data (SW) or to allow continuous data flow between the MC1-UHD and the device (None). The default is None.
11. Close the **Configure the serial connection** dialog.

The new settings are automatically applied.

## Reserving Crosspoints for Automation Use

Under Automation control with the MC1-UHD **Switch Request** feature set to **Router Crosspoint**, the MC1-UHD will use the first crosspoint with its **Type** set to **Router** that matches the desired crosspoint source. When the desired crosspoint source is not permanently mapped to a crosspoint button, the first available **Router Extra** button will be temporarily mapped to the desired crosspoint source. If all **Router Extra** buttons are in use, or there are none assigned, the automated switch request will fail.

### To reserve crosspoints for Automation Use

1. In the **Presmaster Control** area of the **Remote Control** tab, click **Device Setup**.  
The **Device Setup** dialog opens.
2. From the **Automation Switch Request** area, select how a crosspoint switch is defined:
  - **Router Crosspoint** — The received value refers to a physical or virtual router crosspoint. This is the default setting.
  - **Button Number** — The received value refers to a specific MC1-UHD crosspoint button on the DashBoard control panel. Note that these crosspoint buttons are defined in the **Crosspoint Map** tab.
3. Close the **Presmaster Control** dialog.  
The new settings are automatically applied.

### To assign a crosspoint as an Router Extra source

1. Navigate to the **Configuration** interface as outlined in “**To display the Configuration interface in DashBoard**”.
2. Select the **Crosspoint Map** tab.
3. Locate the row for the router source you wish to map.
4. Use the **Source Type** menu to select **Router**.
5. Use the **Selection** menu to select **Router Extra**.
6. Use the **Alpha** menu to select **None**.
7. Select the **Update Router Extra Labels** box to enable the crosspoint button label (on the On Air Control interface) to update with the currently selected router source.

## Supported Commands

**Table 13** summarizes the automation commands supported by the MC1-UHD.

**Table 13 Supported Commands**

Command	Code	Supported	Notes
<b>Simple Commands</b>			
SET_TRANS_TYPE	0x01	✓	<ul style="list-style-type: none"> <li>• Transition type 00 is a protocol extension used to deactivate BKGD INCL. It does not affect the transition type.</li> <li>• Transition types 01-05 are supported</li> <li>• Transition types 06-19 are used to select the SqueezeBack transition type</li> </ul>

**Table 13 Supported Commands**

Command	Code	Supported	Notes
ENQ_STAT	0x02	✓	Results in the return of the following tallies: current crosspoint state on the Program and Preset buses, voice over states, and the current transition type. The following tallies are not returned: DSK states, transition rate, auxiliary bus source.
SET_TRANS_RATE	0x03	✓	<ul style="list-style-type: none"> <li>• Sets the transition rate in frames.</li> <li>• Range is between 1 and 99 inclusive.</li> <li>• Default rate is set to 60 frames.</li> <li>• Upon setting a rate a tally is also sent.</li> </ul>
SET_DSK1_STATE	0x06		
SET_DSK2_STATE	0x07		
SET_PRG_VID_SRC	0x09	✓	Refer to “ <b>Automation Switch Request</b> ”.
SET_PRG_AUD_SRC	0x0A		Audio follows video
SET_PRESET_VID_SRC	0x0B	✓	Activates BKGD INCL. Refer to “ <b>Automation Switch Request</b> ”.
SET_PRESET_AUD_SRC	0x0C		Audio follows video
SET_AUX_VID_SRC	0x0D	✓	Refer to “ <b>Automation Switch Request</b> ”.
SET_AUX_AUD_SRC	0x0E		Audio follows video
TAKE_ALL	0x0F	✓	
TAKE_AUDIO	0x10		
AO_STATE	0x13		
AO_SRC	0x14		
SRC_TABLE_SET	0x1A		
MIXER_POLL	0x1E	✓	Always returns 0xFF 0x1E
AO_LEVEL	0x24		
PRG_LEVEL	0x25		
SRC_CHN_LEVEL	0x26		
DSK_CLIP_LEVEL	0x27		
DSK_GAIN_LEVEL	0x28		
SRC_GAIN	0x29		
SET_AUTO_STATE	0x2B		
START_AUDIO_LEAD	0x2C		Audio leading fixed at 1 frame
ABORT_AUDIO_LEAD	0x2E		
START_AUDIO_LAG	0x2F		
ABORT_AUDIO_LAG	0x31		
DSK1_SETTING	0x32		
DSK2_SETTING	0x33		



**Table 13 Supported Commands**

Command	Code	Supported	Notes
SET_AUDIO_MODE	0x34	✓	<ul style="list-style-type: none"> <li>• Supports 4 pairs, plus mute and phase inversion</li> <li>• Select from any of the 8 possible input pairs (and of the 16 embedded channels)</li> <li>• Mute bits apply to both channels of an audio pair</li> <li>• Phase Reverse bits apply to the second channel of the pair only</li> <li>• Crosspoint selection applies to either a crosspoint number or to a router input, as defined by the Automation Switch Request. Refer to “<b>Automation Switch Request</b>”. <ul style="list-style-type: none"> <li>› When using a router input, the Audio Mode applies to all crosspoints mapped to the specified router input.</li> <li>› When the specified router input is not mapped to any crosspoint, the command is ignored.</li> </ul> </li> <li>• Takes effect the next time the specified crosspoint is selected on a TAKE or hot-punch transition.</li> </ul>
SET_AO_RATE	0x38		
SET_U_FADE_TIMES	0x3C		
<b>Extended Commands</b>			
IS2_TUNNEL	0x0001		
TAKE_VIDEO	0x0010		Video and audio are switched together.
DSK_ARM	0x0006	✓	
DSK_STATE	0x0007	✓	<ul style="list-style-type: none"> <li>• Enables you to activate/deactivate a specified key using a fade or a cut transition on the Program bus.</li> <li>• The transition rate used will always be determined by the automation rate, as specified by the Simple Command 0x03.</li> </ul>
LOAD_PREV_IMG	0x0032		
LOAD_IMG	0x0033	✓	<p>Load file into specified DSK. DSK 0 to 1 load specified file into DDR for Logo 1 to 2 respectively. DSK 127 (7Fh) pre-loads file into the DDR only for fast recall into usable Logo 1 to 2, when needed.</p> <p>★ Ensure the <b>FILENAME</b> contains the directory name and the file name. While the <b>FILENAME</b> does not need to be complete, it still requires enough characters to uniquely identify the file in the directory.</p> <p>A tally is sent regardless of the outcome. The expected tally is now returned if the file is already loaded. On a failure to load a file, a tally is returned with a zero-length filename.</p>
VO_ARM	0x0013		
VO_STATE	0x0014		
VO_PRESET	0x0024		
VO_DUCK	0x0025		
ENQ_DSK_IMG	0x0034	✓	<p>Inquire DSK image exists; causes return of four tallies (one for each logo). Includes a tally for DSK 127.</p>
VO_RATE	0x0038		
VO_SHUFFLE	0x0026		

**Table 13 Supported Commands**

Command	Code	Supported	Notes
VGPI_ARM	0x0130	✓	<ul style="list-style-type: none"> <li>• Supports a maximum of sixteen VGPIs (VGPI 0 to VGPI 17)</li> <li>• This command will be ignored when the specified SqueezeBack Preset is on Program</li> <li>• When in Arm Up state, the command includes the specified SqueezeBack Preset in the transition (the <b>SQUEEZE</b> button is lit on the On Air Control interface)</li> <li>• When in Arm down/Disarm state, the command excludes the specified SqueezeBack Preset in the transition (the <b>SQUEEZE</b> button is unlit on the On Air Control interface)</li> </ul>
VGPI_STATE	0x0140	✓	<ul style="list-style-type: none"> <li>• When no SqueezeBack Preset is on Program and this command is in the Up state, selects the effect type of VGPI and transitions the selected effect on Program.</li> <li>• When a SqueezeBack Preset is on Program and this command is in the Down state, the VGPI which has the same effect as the current one will be handled and the current effect will be off air or on Preview.</li> <li>• In other cases, the command will be ignored.</li> </ul>
SET_PCS_CHN	0x0040		
GET_PCS_CHN	0x0041		
AUTO_TALLY_ENA	0x0042	✓	<ul style="list-style-type: none"> <li>• Enables the periodic sending of the automation status tally (0842) every # seconds (the rate is set by command).</li> <li>• Reports to the automation system the current state of the ATMN button</li> </ul>
SET_PAN_SHOTBOX	0x0043		
GET_PAN_SHOTBOX	0x0044		
CHECK_MEDIA	0x0047		
DISCONN_PAN	0x0048		

## Supported Presmaster Tallies

**Table 14** summarizes the automation tallies supported by the MC1-UHD.

**Table 14 Supported Presmaster Tallies**

Name	Tally ID	Supported	Notes	Included in ENQ_STAT (0x02)
Program Video Source	49	✓	Refer to " <b>Automation Switch Request</b> "	✓
Program Audio Source	4A	✓	<b>Audio</b> follows video	✓
Preset Video Source	4B	✓	Refer to " <b>Automation Switch Request</b> "	✓
Preset Audio Source	4C	✓	<b>Audio</b> follows video	✓
Aux Video Source	4D	✓	Refer to " <b>Automation Switch Request</b> "	✓
Aux Audio Source	4E		Audio follows video	
Take Complete	4F	✓		
Take Audio	50			
V/O State	53	✓	Sent on change in voice over state	✓

**Table 14 Supported Presmaster Tallies**

Name	Tally ID	Supported	Notes	Included in ENQ_STAT (0x02)
U-Fade Rate	7C			
Transition Type	41	✓		✓
Transition Rate	43	✓		✓
Mixer Poll	5E	✓	Always returns 0xFF, 0x5E	
Source Audio Parameters	6E			
DSK Clip Value	67			
DSK Gain	68			
DSK State	Ext 0x0806			
VO Arm State	Ext 0x0813			
VO Parameters	Ext 0x0826			
Image Load State	Ext 0x0833	✓	Sent whenever a new image file has loaded, via automation or otherwise. Reports DSK 0 to 1 when loaded file into DDR for Logo 1 to 2, respectively. Reports DSK 127 (7Fh) when file is pre-loaded into DDR only (this can only originate via automation).	
DSK Image Existence	Ext 0x0834	✓	Response to the "ENQ_DSK_IMG" command. Includes DSK 0 to 1, Logo 1 to 2 respectively, a flag byte set if specified file is loaded on the corresponding logo and the filename.	
Current VGPI State	Ext 0x0940			
Set Panel to Channel on PCS	Ext 0x0840			
Get Which Channel a Panel is connected to	Ext 0x0841			
Automation Control Status	Ext 0x0842	✓		
Current Shot Box Selected on Panel	Ext 0x0843			
Tally Sent when a Panel Acquires a Channel	Ext 0x0845			
Tally Sent when a Panel Drops a Channel	Ext 0x0846			
Tally Sent Back from Intuition to Show which Files, if any, are Missing in a Template	Ext 0x0847			
Automation Assist Command	Ext 0x0928			

## Automation Switch Request

The Automation Switch Request feature uses Simple Commands 0x09, 0x0B, and 0x0D and is applicable when operating with an Automation system. This feature defines the crosspoint switch as a router crosspoint number or as an MC1-UHD button map number.

In order to access button 20, an extended message must be provided as specified in the Presmaster protocol specification. For example, `FF 09 7F 00 14` would be sent for the Program bus.

## Take Command

**Table 15** outlines the additional tallies available when the **Take Button on Panel** setting in the **Personality** tab is set to **Take Next**.

**Table 15 Additional Tallies**

Name	Tally	Notes
Automation Disabled	FF 6B 01 00	Sent when the operator disables automation using the ATMN button on the MC1-UHD interfaces.
Automation Enabled	FF 6B 01 01	Sent when the operator enables automation using the ATMN button on the MC1-UHD interfaces.
Take Next Released	FF 6B 03 00	Sent on completion of a TAKE operation and after the "Take Next Asserted" tally. Automation must be enabled on the MC1-UHD.
Take Next Asserted	FF 6B 03 01	Sent when the operator presses the TAKE button on the On Air Control interface, or MC1-PANEL-16 control panel. Automation must be enabled on the MC1-UHD.

# Using the APC Protocol

This chapter outlines how to setup MC1-UHD communications with a third-party device via the APC protocol.

## For More Information on...

- the APC protocol, refer to the documentation that came with your device.

## Configuring an Ethernet Connection for APC

Before you proceed, ensure that the MC1-UHD is connected to your facility network and assigned a valid IP Address.

## For More Information on...

- network cabling requirements, refer to “**Cabling the Ethernet Port on the OGX-FR Frame**”.
- assigning an IP Address, refer to “**Configuring the Initial Network Settings**”.

## Configuring the MC1-UHD for Ethernet APC Communications

This section outlines how to configure the MC1-UHD to communicate with the APC Ethernet protocol.

### To enable the APC protocol for ethernet communications

1. Navigate to the **Configuration** interface as outlined in “**To display the Configuration interface in DashBoard**”.
2. Select the **Remote Control** tab.
3. Locate the **APC Control** area of the tab.
4. Select the box in the **APC Control** area.
5. From the **Connection** menu, select one of the following:
  - **Network Client** — The MC1-UHD functions as a service requester that initiates communications with a server on the network.
  - **Network Server** — The MC1-UHD functions as a host, or socket listener, on the network. This is the default.
6. Click **Network Setup**.

The **Network Setup** dialog opens.

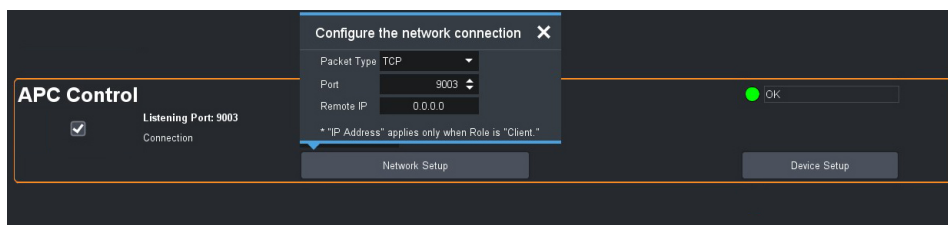

7. Use the **Packet Type** menu to specify the Ethernet protocol your external device will use to communicate with the MC1-UHD. The default is TCP.
8. Use the **Port** field to specify the port that the MC1-UHD will listen on. The default is 9003.
9. If you selected **Network Client** in step 5, use the **Remote IP** field to specify the IP Address of the MC1-UHD on the network to be used for APC communications.

★ The **Remote IP** field value is ignored when the **Connection** is set to **Network Server**.

10. Close the **Network Setup** dialog.

The new settings are automatically applied.

## Configuring a Serial Connection for APC

APC commands can be sent to the MC1-UHD via the **SERIAL** port (RS-422) on the card's rear module.

★ Refer to the documentation for your external device for specific cabling requirements.

### Cabling Requirements

Refer to "**Serial Cabling**" for details on connecting an RS-422 serial device to the MC1-UHD rear module.

### Configuring the MC1-UHD for Serial APC Communications

This section outlines how to configure the MC1-UHD to communicate with the APC Serial protocol.

#### To enable the APC protocol for Serial communications

1. Navigate to the **Configuration** interface as outlined in "**To display the Configuration interface in DashBoard**".
2. Select the **Remote Control** tab.
3. Locate the **APC Control** area of the tab.
4. Select the box in the **APC Control** area.
5. From the **Connection** menu, select **Serial Port**.
6. Click **Serial Port Setup**.

The **Configure the serial connection** dialog opens.

7. Set the **Port Type** to **RS-422**. This must match the serial cable type that connects the MC1-UHD to the external serial device.

★ The Bit Rate, Data Bits, Parity, and Stop Bits values are reset to their default values when a different type is selected.

8. Use **Table 16** to set the required parameters for the APC.

**Table 16 Setup Parameters**

Parameter	Setting
Bit Rate	38400
Data Bit	8
Parity	Odd
Stop Bit	1

9. Use the **Flow Control** menu to enable the MC1-UHD notify the serial device when it is experiencing a data overflow and stop sending data (SW) or to allow continuous data flow between the MC1-UHD and the device (None). The default is None.

10. Close the **Configure the serial connection** dialog.

The new settings are automatically applied.

## Reserving Crosspoints for Automation Use

Under Automation control with the MC1-UHD **Switch Request** feature set to **Router Crosspoint**, the MC1-UHD will use the first crosspoint with its **Type** set to **Router** that matches the desired crosspoint source. When the desired crosspoint source is not permanently mapped to a crosspoint button, the first available **Router Extra** button will be temporarily mapped to the desired crosspoint source. If all **Router Extra** buttons are in use, or there are none assigned, the automated switch request will fail.

### To reserve crosspoints for Automation Use

1. In the **APC Control** area of the **Remote Control** tab, click **Device Setup**.  
The **APC Control** dialog opens.
2. From the **Switch Request** area, select how a crosspoint switch is defined:
  - **Router Crosspoint** — The received value refers to a physical or virtual router crosspoint. This is the default setting.
  - **Button Number** — The received value refers to a specific MC1-UHD crosspoint button on the DashBoard control panel. Note that these crosspoint buttons are defined in the **Crosspoint Map** tab.
3. Close the **APC Control** dialog.  
The new settings are automatically applied.

### To assign a crosspoint as an Router Extra source

1. Navigate to the **Configuration** interface as outlined in “**To display the Configuration interface in DashBoard**”.
2. Select the **Crosspoint Map** tab.
3. Locate the row for the router source you wish to map.
4. Use the **Source Type** menu to select **Router**.
5. Use the **Selection** menu to select **Router Extra**.
6. Use the **Alpha** menu to select **None**.
7. Select the **Update Router Extra Labels** box to enable the crosspoint button label (on the On Air Control interface) to update with the currently selected router source.

## Supported Commands

**Table 17** lists the APC commands the MC1-UHD supports.

**Table 17 APC Commands**

Command	Description
TAKE	Performs a transition/Take via preset
PGM	Loads the Program source to the indicated channel
PST	Loads the Preset audio/video channel via the specified transition type at a specified transition rate
OVER	Controls the audio over on either program or preset bus. <ul style="list-style-type: none"><li>• The first channel is audio over as on the on-air display.</li><li>• The second channel controls the EAS audio over channel.</li></ul>
DSK	Loads the Key via the specified transition type at a specified transition rate

**Table 17 APC Commands**

<b>Command</b>	<b>Description</b>
STATUS	Requests the On Air status of the keys, PST, and PGM
CHANGE	Reports when a status change occurs in the device
ERROR	Reports when a communication error occurs on the device



# Setting up an EAS with MC1-UHD

This chapter outlines how to set up communications between an EAS decoder and the MC1-UHD via the SAGE EAS protocol.

★ EAS communication requires an MC1-UHD-MASTERCTRL-LICENSE. Refer to “**Licensed Features**”.

## Cabling Requirements

Before you begin, confirm how your EAS device will communicate with the MC1-UHD:

- via the Control® DeviceMaster® over ethernet
- via a serial connection

★ Set up with an EAS requires an R3B-GATOR (8322AR-318D) or R3A-GATOR (8322AR-319C) rear module.

### For More Information on...

- configuring a Control DeviceMaster, refer to “**Control® DeviceMaster® Setup**”.
- the MC1-UHD rear modules, refer to “**MC1-UHD Cabling Overview**”.

## MC1-UHD Setup

This section outlines how to configure the MC1-UHD to communicate via the SAGE EAS ethernet protocol.

### To set up ethernet communications via the SAGE EAS protocol

1. Navigate to the **Configuration** interface as outlined in “**To display the Configuration interface in Dashboard**”.
2. Select the **Remote Control** tab.
3. Locate the **SAGE EAS Char Gen** area in the tab.
4. Select the box in the **SAGE EAS Char Gen** area.

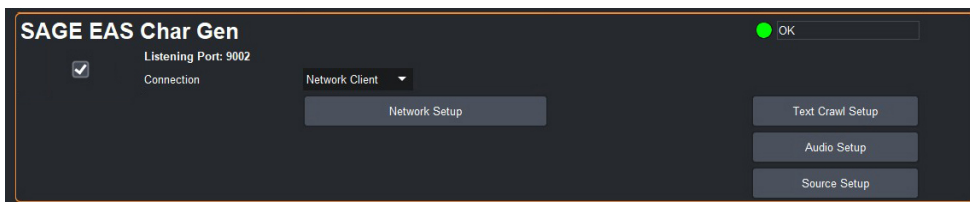

5. From the **Connection** menu, select **Network Client**.

The MC1-UHD functions as a service requester that initiates communications with a server on the network.

6. Click **Network Setup**.

The **Network Setup** dialog opens.

7. Use the **Packet Type** menu to specify **TCP**.
8. Ensure the **Port** field is set to **7788**.

9. Use the **Remote IP** field to specify the IP Address of the EAS device.

10. Close the **Network Setup** dialog.

The new settings are automatically applied.

11. From the **Port** menu, specify the port number that is connected to the EAS device.

12. Select the **Enabled** box.

The **Text Crawl** sub-tab now displays in the **On Air Control** > **Logos** tab of DashBoard. This tab will be used to configure the text overlay as described in the section “**Customizing the EAS Text Overlay**”.

13. Confirm that the EAS device reports a valid connection.

## Customizing the EAS Text Overlay

The MC1-UHD provides an overlay engine that is capable of displaying an EAS horizontal text crawl in real time. EAS messages are grouped into categories as determined by the EAS device you are using. The MC1-UHD provides options for customizing the appearance of each message category such as font size and color, background color, and pan speed.

★ The overlay is automatically loaded into a dedicated Logo channel.

### To customize the EAS text overlay

1. Navigate to the **Configuration** interface as outlined in “**To display the Configuration interface in DashBoard**”.

2. Select the **Remote Control** tab.

3. Locate the **SAGE EAS Char Gen** area of the tab.

4. Click **Text Crawl Setup**.

The **SAGE EAS** dialog opens.

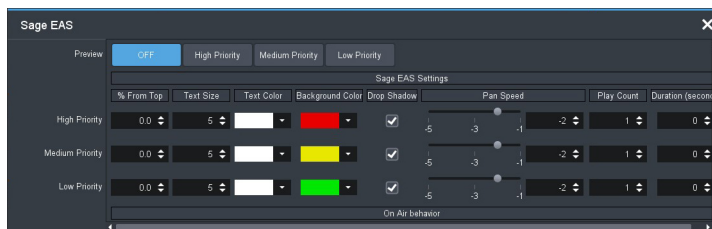

5. Use the **% From Top** slider to adjust the vertical position of the EAS text overlay. Note that this setting is not applicable to the Emergency Alert (High Priority) categories as these messages are fixed to the top of the screen.

6. Use the **Text Size** slider to adjust the font size of the text overlay from smallest (1) to largest (10). Note that actual text size is dependent on the video format.

7. Select a text color and/or background color for the text overlay using the provided fields. The **EAS Text Attributes** field reports an error when the text color and the background color match.

★ When using very long EAS messages, the MC1-UHD may use a smaller font size and/or may disable transparency. The exact length depends on the characters used in the message (widths of each font character).

8. To apply a drop shadow to the text overlay, select the **Drop Shadow** box.

9. Use the **Pan Speed** slider to specify the speed of the EAS text crawl across the screen.

10. Use the **Play Count** field to specify the number of times to display the entire text crawl before taking it off air.

11. Use the **Duration** field to specify the number of seconds the EAS text crawl will display before it is taken off air.
12. Repeat 5 to 11 for each message category you want to configure.
13. Close the **SAGE EAS** dialog.

### To specify the On Air behavior of the EAS text crawl

1. Display the **SAGE EAS** dialog as outlined in steps 1 to 4 in the above procedure.
2. Locate the **On Air Behavior** area of the dialog. You may need to scroll down to locate this area.

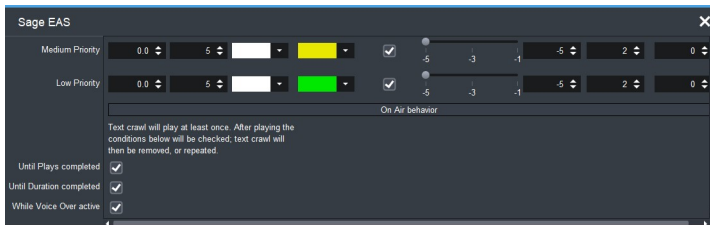

3. Select the **Until Plays Completed** box to enable the EAS text crawl to continue to play until the number of plays equals the value specified in the **Play Count** menu of the **SAGE EAS** dialog.
4. Select the **Until Duration Completed** box to enable the EAS text crawl to continue to play until the value in the **Duration** menu is reached.
5. Select the **While Voice Over Active** box to enable the EAS text crawl to continue to play only while the EAS Voice Over source is playing.
6. Close the **SAGE EAS** dialog.

## EAS Voice Over

The MC1-UHD enables flexible audio/voice over mixing with a variable program audio level, audio over gain control, and preset mixing with transition control. When EAS is active, all channels are mixed. If the source may contain more audio channels that you want mixed, ensure to use the Mute setting for those channels.

When setting up the gain and duck levels, note that audio sources are layered with the EAS positioned downstream from the Voice Over channel. For example, applying a duck level when EAS is active, also applies that value to the Voice Over channel (if active) and the other incoming audio sources. That means when both Voice Over and EAS audio are in effect, it is possible to duck the incoming audio twice.

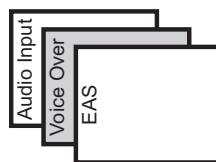

Figure 15 Audio Layering

## Configuring the Audio Source for EAS

This section outlines how to configure the embedded audio sources for the EAS audio transitions.

- ★ EAS audio input must be connected to an AES audio input (MC1-UHD-A and MC1-UHD-B only).

### To set up an EAS source

1. Navigate to the **Configuration** interface as outlined in **“To display the Configuration interface in DashBoard”**.
2. Select the **Remote Control** tab.
3. Locate the **SAGE EAS Char Gen** area of the tab.
4. Click **Source Setup**.

The **Voice Over** dialog opens.

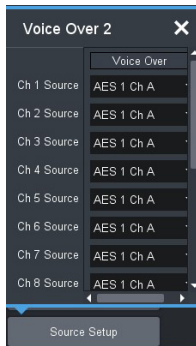

5. From the **Voice Over** field, select the audio source to include in the output.  
★ Silence is embedded if the selected source is not present on the input video.
6. Close the **Voice Over** dialog.

### Setting the EAS Duck and Gain Levels

When EAS is active, all audio channels on the Program shall be adjusted by a value specified on the Remote Control > SAGE EAS Char Gen > Voice Over Audio Setup dialog. The default is to reduce the gain by 10dB.

When using a Sage Digital ENDEC EAS, the MC1-UHD reacts to the Sage Push To Talk (PTT) relay closure to activate audio voice over. While the PTT relay is closed, the MC1-UHD applies the EAS Duck Level specified via the Audio Setup dialog to the incoming Program audio and performs a cut transition by mixing the incoming audio from the channel at a specified level.

★ If both Voice Over and EAS audio are in effect, the incoming audio is ducked twice.

### To set the EAS duck level

1. Ensure that you have configured a port on the MC1-UHD rear module for the EAS protocol you are using.
2. Navigate to the **Configuration** interface as outlined in **“To display the Configuration interface in DashBoard”**.
3. Select the **Remote Control** tab.
4. Locate the **SAGE EAS Char Gen** area of the tab.
5. Click **Audio Setup**.

The **Voice Over Audio Setup** dialog opens.

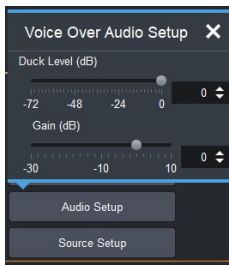

6. Use **Duck Level** slider to specify the amount (dB) to reduce the audio level on the Program bus during an EAS alert.
7. Use the **Gain** slider to apply a gain (in dB) to the Voice Over (EAS) channel.

## EAS Status

The On Air Control > Home > EAS STATUS field reports if the connected EAS device is providing content to the text overlay of the MC1-UHD. This field is located at the bottom of the Home tab. (Figure 16)

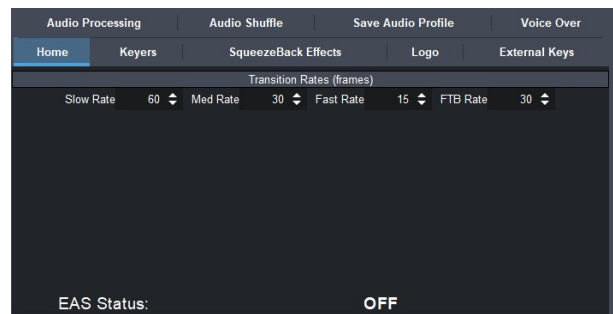

Figure 16 Example of a Home Tab with EAS STATUS Field

When the EAS STATUS field reports **OFF**, the MC1-UHD text overlay does not include EAS content. When the EAS STATUS field reports **ON**, followed by color-coded text, an installed EAS is provides content to the MC1-UHD text overlay. This text also displays in this area when the EAS is active.



# On Air Control Overview

This chapter provides a basic introduction to the MC1-UHD, including an overview of the different areas of the On Air Control interface, using the menu system, as well as a brief summary of how video is controlled by the MC1-UHD.

## Menu System Basics

The **On Air Control** interface enables you to set up and perform transitions, configure keys, monitor and control audio levels. This section provides a brief overview of the controls available in this interface.



Figure 17 MC1-UHD — On Air Control Interface

- |                     |                    |                         |                       |
|---------------------|--------------------|-------------------------|-----------------------|
| 1) Setup Tabs       | 3) Transition Area | 5) Fade to Black Button | 7) Program Audio Area |
| 2) Crosspoint Buses | 4) Keyer Area      | 6) Automation Button    |                       |

### 1. Setup Tabs

The tabs located near the top left of the interface provide options for configuring the keyers, on-air controls, and selecting logo channel sources. Refer to the chapter refer to the section “DashBoard Menus” on page 45 for a list of the tabs and parameters available.

### 2. Crosspoint Buses

This area is used to select the video sources for each bus. Each crosspoint button will display the name of its source on the button face. The default bus mapping is outlined in refer to the section “Default Crosspoint Mapping” on page 55. The following buses are available:

- › **Program Bus** — The Program Bus is used to select the video source that will show as the Background on the Program output. After performing a factory default reset, the **BLACK** button is selected on this bus.
- › **Preset Bus** — The Preset Bus is used to select the video source that is visible on the Preview output. After performing a factory default reset, the **BLACK** button is selected on this bus.

### 3. Transition Area

This area provides the options for selecting transition rates (slow, medium, fast), and type (take, fade-fade, take-fade, mix, fade-take). Refer to the chapter refer to the section “Transitions” on page 111 for details.

### 4. Keyer Area

This area includes the four keyers of the MC1-UHD and allows you to perform the key transitions. Refer to the chapter refer to the section “Keying” on page 105 for details.

### 5. Fade to Black Button

Use this button to fade the Program bus to black. The Fade to Black (FTB) rate is specified in the **Home** tab. After performing a factory default reset, this button is toggled off (unlit).

### 6. Automation Button

Toggling this button on (button will be lit) allows an Automation System to control the MC1-UHD. After performing a factory default reset, this button is toggled on (lit).

### 7. Program Audio Area

This area includes an audio fader that enables you to control the Program audio gain. The slider is set by default to 0 and has a range of -72 to +20dB. Use the **Default** button to reset the audio gain.

## Switcher Basics

This section gives an overview of how video is controlled by the MC1-UHD. This includes video sources, video layering, and preview. For information on setting up crosspoints, refer to refer to the section “Mapping the Program and Preset Crosspoints” on page 56.

## Video Sources

The MC1-UHD has access to two basic types of video sources: external and internal. All video sources can be assigned to video source (crosspoint) buttons. By pressing a crosspoint button on a bus, the video source assigned to that button is selected.

- **External** — video sources that come from SDI inputs on the rear module.
- **Internal** — video sources that come from internally generated video, such as any of the two internally generated Logo channels, or an internally generated black, or one of the matte generators.

To select a video source on a bus, you must identify the bus you want to assign a video source to and then press the crosspoint button you want to select on that bus.

## Video Layering

Key layering is fixed for the MC1-UHD and starts with Background and proceeds to Keyer 4.

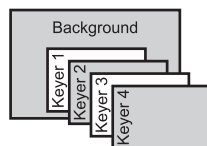

Figure 18 Video Layering



## Video Preview

Video preview allows you to use an additional monitor to preview what the next shot is going to be. The Preset bus of MC1-UHD shows what is selected for the next transition. This includes the keys and background video sources that will be on-air after the next transition.

## DVE Transitions

The MC1-UHD can be used to perform on-air 2D DVE (SqueezeBack) transitions to reveal another video source or graphic. You can also transition to pre-squeezed effects with standard transitions, squeeze in any direction on either X or Y axis, or both. Refer to “**SqueezeBack Effects**” for more information.

★ DVE transitions require the MC1-UHD-DVE-1CH-LICENSE. Refer to “**Licensed Features**”.

## Displaying the On Air Control Interface

You can choose whether to display the entire On Air Control interface at full-screen mode on a DashBoard client computer.

### To set the MC1-UHD On Air Control interface to full-screen

- Press **Shift+F11** to display the interface in full-screen mode; or
- Select **Window > Full Screen** from the DashBoard toolbar.

★ To exit out of full-screen mode, press **Shift+F11** again.



# Channel Select Buttons

When using multiple MC1-UHD cards, it may be desirable to control any MC1-UHD from a DashBoard console. To facilitate switching between multiple MC1-UHD cards, a row of dedicated Channel Select buttons is provided in the upper left of the On Air Control interface. You can change the icons displayed in the Channel Select Buttons, the Basic Tree View node, and the Home tab by updating the corresponding graphic files stored on the MC1-UHD card.



Figure 19 Example of the Channel Select Row of the On Air Control Interface

This chapter outlines how to update the icons for an MC1-UHD and assign a MC1-UHD card to a Channel Select button.

## Before You Begin

Keep the following in mind when using multiple MC1-UHD<sup>1</sup> cards:

- The Channel Select buttons must be setup on each MC1-UHD card.
- When setting up the Channel Select buttons, it is important that the sequence of devices be consistent. Otherwise the buttons will appear to “move around” when toggling between interfaces. This cannot be enforced automatically, the user must be careful when setting up the buttons.
- If the IP address of any MC1-UHD cards changes, then the Channel Select buttons will not work correctly. Specifically, the red background color that indicates the currently active device will not be correct. It is highly recommended to use static IP addresses to avoid this problem.

If either of these problems occur, they can easily be fixed by simply repeating the procedure “**Configuring the Channel Select Buttons**”.

## Updating the Icons

It is intended for users to update the icon graphics for each MC1-UHD with their own versions, particularly if they have more than one MC1-UHD. For example, you may wish to identify each MC1-UHD by using a specific station logo. This section summarizes the graphic files used by a card.

1. This also applies to MC1-MK cards.

Prior to configuring the Channel Select buttons, each MC1-UHD should be given a custom set of icon (station logo) graphics as described in this section. Channel Select buttons will operate with the default logos, but it may be confusing to the operator.

## Graphic Files

The graphic files are stored on the Micro SD card of the MC1-UHD in a top-level directory on the card named **media**. Note that the underlying file system (ext3) is case-sensitive, and that both the directory and the filenames are lower-case. Inside the **media** directory there are three files containing icons (station logos) in various sizes. (**Table 18**)

When replacing the content of these files, ensure that the image dimensions remain the same. For best results, also ensure that these images have a transparent background.

**Table 18 Image Files for Multi-Channel Setups**

Filename	Image Dimensions	Used for...
station_logo_icon.png	16 x 16 pixels	Basic Tree View node icon
station_logo_small.png	50 x 50 pixels	Channel Select button icon
station_logo_large.png	450 x 250 pixels	On Air Controls, Home tab icons

## Managing the Graphic Files

Use an FTP client to connect to the MC1-UHD and replace the graphic files stored on the card. This is exactly the same procedure as is used to load other graphics files to logo channels on the MC1-UHD. Refer to “**Connection using FTP**” for details.

Once new files are transferred to the MC1-UHD via FTP, they will immediately be used. However, DashBoard software caches the images and may not display the new icons right away. Refreshing the card (click the **Refresh** button), or restarting DashBoard, generally fixes this problem.

## Configuring the Channel Select Buttons

The Channel Select buttons are located in the upper left corner of each card’s On Air Control interface. (**Figure 19**) Until these are configured by the user, they appear as empty buttons. Clicking the empty buttons has no effect. You can specify the number of Channel Select buttons, to a maximum of 10, that display in the interface.

These buttons allow you to toggle between the On Air Control interfaces of multiple MC1-UHD Master Control Switchers. Selecting a button displays the corresponding MC1-UHD **On Air Control** interface in DashBoard. A lit button indicates that the corresponding On Air Control interface is the currently active card in DashBoard.

- ★ It is highly recommended to consistently assign MC1-UHD cards to the Channel Select buttons. For example, assigning the same MC1-UHD to the first Channel Select button regardless of the On Air Control interface ensures that the clicking the first Channel Select button displays the same MC1-UHD.

### To specify the number of Channel Select buttons

1. Navigate to the **Configuration** interface as outlined in “**To display the Configuration interface in DashBoard**”.
2. Select the **Crosspoint Map** tab.
3. Specify the number of buttons to display in the On Air Control interface of that MC1-UHD by typing the number into the **Number of Channel Select Buttons** field.

- ★ You may need to scroll down the tab to locate this field.

4. Repeat steps 1-4 for each MC1-UHD you wish to configure.

#### **To configure the first MC1-UHD**

1. Display the **On Air Control** interface of the first MC1-UHD as outlined in “**To display the On Air Control interface in DashBoard**”.
2. Return to the **Tree View**.
3. Assign the first MC1-UHD to the first Channel Select button as follows:
  - a. Select the **On Air Control** node and keep the mouse button pressed.
  - b. Drag the node over the first Channel Select button. Notice the mouse pointer changes shape when over the target button.
  - c. Release the mouse button. The Channel Select button updates to show the appropriate logo for the first MC1-UHD.
4. Repeat step 3 for the second MC1-UHD, but ensuring to assign the second MC1-UHD to the second Channel Select button.
5. Assign each additional MC1-UHD to a button in **On Air Control** node of the first MC1-UHD.

#### **To set up additional MC1-UHD**

1. Display the **On Air Control** interface of the next MC1-UHD as outlined in “**To display the On Air Control interface in DashBoard**”.
2. Return to the **Tree View**.
3. Drag the On Air Control node of the first MC1-UHD to the first Channel Select button on the next MC1-UHD On Air Control interface.
4. Drag the On Air Control node of the second MC1-UHD to the second Channel Select button on the next MC1-UHD.
5. Repeat for each additional MC1-UHD to add the buttons to the On Air Control interface for each MC1-UHD.



# Audio

This chapter provides instructions for configuring the audio features of the MC1-UHD using the options available in DashBoard. This includes how to map the audio channels, adjust the gain, and specifying the Voice Over source.

## Audio Overview

The MC1-UHD provides the ability to independently configure the audio channel map and gain of each input (up to 16) that can be selected on the crosspoint bus, and to adjust the gain, or mute, individually, each of the 16 embedded channels. The audio processing and shuffle settings are retained on a per crosspoint basis. In addition, audio settings can be saved to one of four audio profiles that can be applied to any crosspoint during a **TAKE** transition.

## Workflow

**Figure 20** provides a simplified workflow diagram of the audio processing.

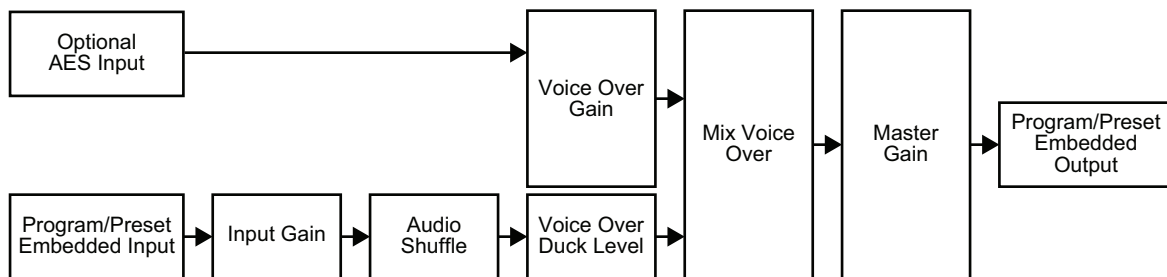

Figure 20 Audio Processing Workflow

### For More Information on...

- automation protocol support for audio, refer to **“Commands”**.

## Identifying the Audio Groups

The MC1-UHD also provides the ability to change the color scheme of the audio group buttons in the On Air Control interface. This allows you to assign a unique color to each group, allowing you to quickly identify the groups on the interface.

### To map the audio channels

1. Navigate to the **On Air Control** interface as outlined in **“To display the On Air Control interface in DashBoard”**.
2. Select the **Audio Shuffle** tab.

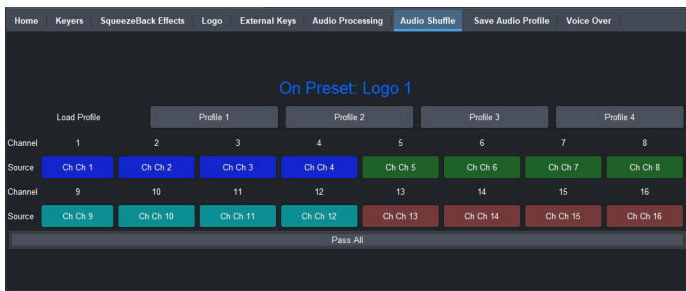

3. To change the audio profile, select the required button from the **Load Profile** area.

4. Locate the channel you wish to map.
5. Click the associated **Source** button.  
The **Select source** dialog opens.
6. Select the source you wish to map to the selected channel.
7. Close the dialog.
8. Repeat steps 4 to 7 for each channel.

## Setting the Master Audio Level

The master audio level can be adjusted manually using the **Audio Gain** slider. This slider applies a gain (in dB), to the audio that is included with the output.

### To set the Master Audio level

1. Navigate to the On Air Control interface as outlined in “**To display the On Air Control interface in DashBoard**”.
  2. Specify the audio gain value using the **Audio Gain** slider.
- ★ The numerical gain value may also be entered directly in the field above the **Reset Audio Gain** button.

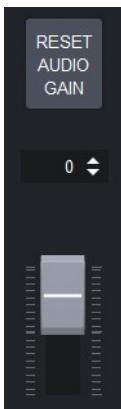

3. You can select the **Reset Audio Gain** button to set the audio gain to 0dB. This resets the gain preset back to 1:1.

## Audio Processing

The MC1-UHD provides the ability to adjust the gain, or mute, individually, each of the 16 embedded channels. The audio processing and shuffle settings are retained on a per crosspoint basis. You can also sum every adjacent pair of audio groups with the first channel on the Odd Channel numbers (e.g. Channels 1 and 2, 3 and 4, 5 and 6 etc.).

- ★ Changes made to settings on the **Audio Processing** tab take effect immediately on the Preview output. The changes will be applied to the Program output on the next Take transition.

### To configure the audio processing

1. Navigate to the On Air Control interface as outlined in “**To display the On Air Control interface in DashBoard**”.
2. Select the **Audio Processing** tab.



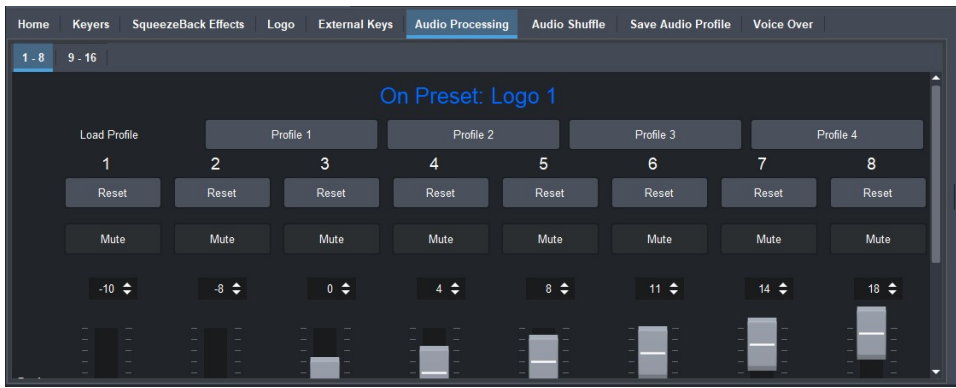

3. Select the sub-tab for the channels you wish to configure. The **1-8** tab is selected by default.
4. To apply a gain to a channel, use the associated **Ch #** slider to select a value between -20dB and +20dB. Note that this does not affect the Audio Over gain levels.
5. To mute a channel, select the associated **Mute** button. When the button is red, the specified output channel is muted.
6. To sum the outputs of channel pairs within a group, select the **Sum** button for the channel pair. Note that both channels will carry the average of the two input channels  $((A+B)/2)$ .
7. To reset the parameters for the specified channel to the default values, select the associated **Reset** button.
8. If required, repeat steps 4 to 6 for each channel in the group.

## Voice Over Setup

This section outlines how to configure the embedded audio sources for the Voice Over feature for audio transitions.

### To set up the voice over source

1. Navigate to the Configuration interface as outlined in **“To display the Configuration interface in Dashboard”**.
2. Select the **Audio Over** tab.
3. From the associated **Sources Ch #** menu, select an audio source to include in the voice over output.

The **Select audio source** dialog opens for the selected audio over channel.

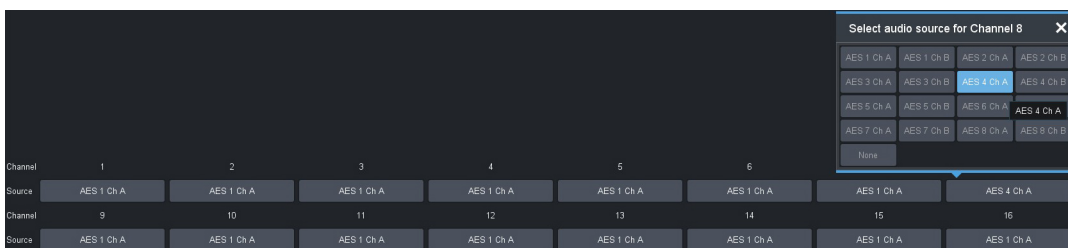

4. Select the audio group and channel to assign it as the audio over source.  
In the example above, the user is assigning AES4 ChA as the source for Audio Over Ch 8.
  5. Close the **Select audio source** dialog.
- ★ Silence is embedded if the selected source is not present on the input video.

## Voice Overs

The MC1-UHD enables flexible audio/voice over mixing with a variable program audio duck level, audio over gain control, and preset mixing with transition control. When Voice Over or EAS is active, all channels are mixed. If the source contains more audio channels that you want mixed, ensure to use the Mute setting for those channels. The Voice Over source is selected using the **Audio Over Sources** tab in the Configuration interface. A Voice Over can also be triggered using GPIs.

### For More Information on...

- setting up GPIs, refer to the chapter “**Configuring the GPI/Tallies**”.

## Setting the Voice Over Duck/Gain Level

You can adjust the duck and gain levels of the Voice Over channel.

★ If both Voice Over and EAS audio is in effect, the MC1-UHD ducks the incoming audio twice. The Voice Over duck/gain is set in the **Voice Over** tab of the On Air Control interface.

### To set the duck/gain level

1. Navigate to the On Air Control interface as outlined in “**To display the On Air Control interface in DashBoard**”.
2. Select the **Voice Over** tab.

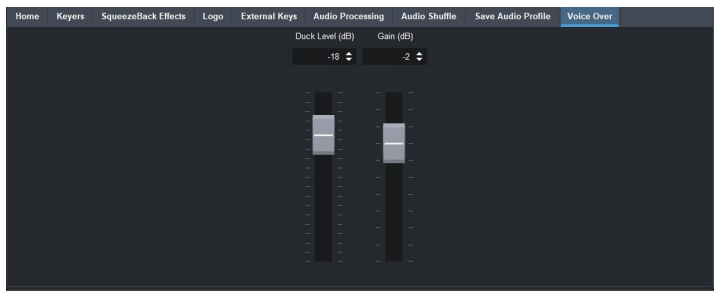

3. Use the **Duck Level** slider to apply a negative gain (in dB) to the Voice Over channel.
4. Use the **Gain** slider to apply a gain (in dB) to the Voice Over channel.

## Including a Voice Over

The Voice Over feature is triggered on/off by pressing the **AUDIO OVER** button located on the On Air Interface. Once the button is selected (button is lit), the voice over will remain active until the button is selected again (button is unlit).

## Audio Profiles

You can define up to four audio profiles. Each profile records the audio processing and shuffling settings for all 16 embedded channels including:

- which audio sources are re-mapped
- gain to the input(s)
- embedded audio source
- pass mode
- mute (enabled or disabled)
- which channels are inverted (or not)
- which channels are summed (or not)

## Creating an Audio Profile

A profile captures all the audio settings, except the Voice Over or EAS settings, currently in use. Each profile displays as a selectable button on the **Audio Processing** tab and **Audio Shuffle** tab of the On Air Control interface.

### To create an audio profile

1. Specify which audio group is embedded for output as outlined in the section “**Identifying the Audio Groups**”.
2. If required, adjust the gain for your audio channels as outlined the section “**Audio Processing**”.
3. Select the **Audio Profile Names** tab in the **Configuration** interface.

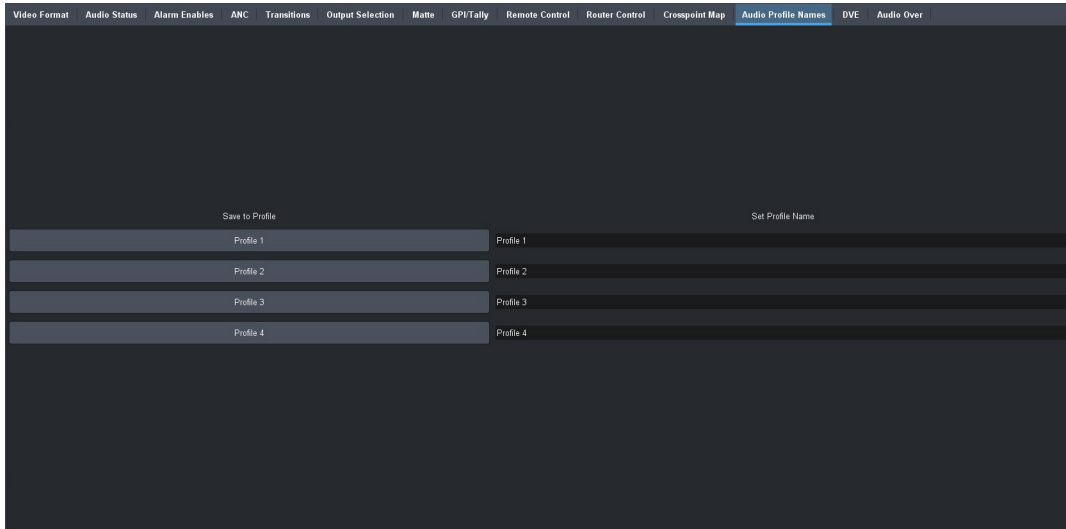

4. In the **Set Profile Name** field for the audio profile:
  - a. Type a unique identifier for your profile.
  - b. Press **Enter** to save.

This becomes the button label on the **Audio Processing** tab and **Audio Shuffle** tab of the On Air Control interface.

5. Repeat step 4 for each profile you wish to update.

## Recalling an Audio Profile

Each of the four audio profiles are defined using the Configuration interface and capture the settings specified in the Audio tabs of that interface. These profiles that can be recalled from the On Air Control interface via the top row of buttons on the **Audio Processing** tab and **Audio Shuffle** tab of the On Air Control interface.

★ Recalling an audio profile does not affect the Voice Over or EAS settings.

### To recall an audio profile

1. Configure the audio profile as outlined in “**Creating an Audio Profile**”.
2. On the **Preset** bus, select the crosspoint button for the source you wish to take to air. The button is now lit blue.
3. Select the **Audio Shuffle** tab to display the available profiles.

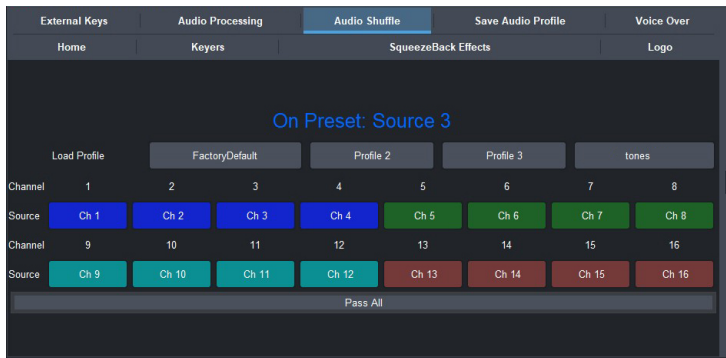

4. Locate the **Load Profile** area of the tab.
5. Select the button for the audio profile that you want to use during the next transition. The profile settings are used until another profile is loaded, or the user changes any of the settings.
6. Select the **TAKE** button.
 

The selected crosspoint is taken to air and the corresponding button is lit in the Program bus. The settings in the audio profile are applied only to this crosspoint during the transition.
7. To apply a different audio profile to the next transition, repeat steps 2 to 6.

# Media File Management

DashBoard enables you to select and configure the two Logo channels that are loaded in the MC1-UHD. Each Logo channel has a sub-tab that enables you to assign a media file to the specified logo, view a thumbnail that represents the media file currently loaded, and adjust on-air properties.

★ The procedures in this chapter assume the On Air Control interface is displayed in the DashBoard window.

## Before You Begin

The following tips and restrictions apply when managing your media files:

- Media files, such as stills and animations, are transferred to and from the MC1-UHD using FTP protocol. The media files are stored on the Micro SD card that is installed on the MC1-UHD.
- When using Mac OS X™ to transfer files to the Micro SD card via an FTP server, you may only have read-only access. Refer to your Mac OS X™ documentation for details.

## Managing your Media Files

The MC1-UHD features two Logo channels (Logo 1, 2) into which you can load files from the Micro SD card physically installed on the Micro SD card. Each MC1-UHD has up to 2GB of DDR playout memory<sup>1</sup>. **Table 19** lists an estimation of how many uncompressed frames can fit into the playout memory of the MC1-UHD.

★ Very large animations may take several minutes to load.

**Table 19 Full Frame Animation**

Format	Image Size	No Alpha	With Alpha
<b>1080i</b>	1920x1080	386	256
<b>1080p</b>	1920x1080	386	256
<b>720p</b>	1280x720	870	579
<b>PAL</b>	720x576	2882	1921
<b>NTSC</b>	720x486	3416	2277

Media files, such as animations and still images, can be transferred to and from the Micro SD card using an FTP connection. Once transferred to the Micro SD card, you use the options in the Logo tab to load the files and assign them to a Logo channel.

This section outlines the specifications for media files and provides general information on using the Micro SD card and an FTP connection.

### For More Information on...

- assigning media files to Logo channels, refer to “**Loading a Media File**”.

## Image Specifications

Media files used on the MC1-UHD must meet the specifications outlined in **Table 20**. Note that if larger images are used, the images will be clipped to the dimensions listed in **Table 20**.

---

1. The MC1-UHD has 1.5GB of DDR playout memory when the MC1-UHD-DVE-1CH-LICENSE license is enabled.

**Table 20 Image Specifications**

Parameter	Specification
Supported File Types	BMP, GIF, JPEG, PNG, TGA
Compression	Compressed and uncompressed
Max. Image Width (all formats)	65,536 pixels
Max. Image Height (all formats)	Dependent on available memory
Animation Maximum Length	10,000 frames

## File Naming Specifications

Keep the following in mind when naming your media files:

- The name can contain letters, numbers, and spaces, but cannot contain symbols such as ! @ # & \* ( ) ? / , ' " .
- If you are naming an animation, each file must be numbered in the sequence that it will play out. The following restrictions apply to file names for animations:
  - › Each file can use a minimum 3-digit number, including all the leading zeros.
  - › The file name and number must be separated by an \_ followed by 3 or more digits, then a period (.).
  - › Each file in the sequence must have the same numbering scheme.
  - › The MC1-UHD loads files in numerical order.

The following is an example of a 10-frame animation using a typical numbering scheme:

```
DTV_B_000 . tga
DTV_B_001 . tga
...
DTV_B_009 . tga
```

## Loading a Media File

When a media file is loaded, data, such as X/Y position, is also loaded, if it exists. Otherwise, the last used values are retained. For animations, parameters are recalled after the last frame is loaded.

### To load a media file into a Logo channel

1. Navigate to the **On Air Control** interface as outlined in **“To display the On Air Control interface in DashBoard”**.
2. Select the **Logo** tab.

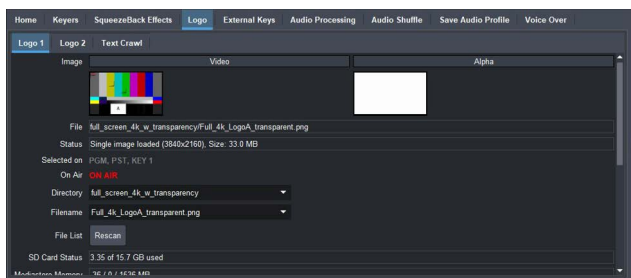

3. Select the sub-tab for the Logo channel you want to load the media file for.

4. If files were added or re-named using an FTP connection, click **Rescan** to update the list of directories and filenames in the tab menus.
  5. From the **Directory** menu, select the directory you wish to load a file from. Choose from the following:
    - [RAM CACHE] — A virtual directory that displays media files that are already loaded in the play-out memory. Selecting this directory enables you to quickly access a pre-loaded file from the memory.
    - [ROOT] — This is the default directory and represents the top-most directory on the Micro SD card. You can manage files on the Micro SD card using an FTP connection.
  6. From the **Filename** menu, select the file.
- ★ You can clear space in the image cache by selecting None from the Filename menu of any Logo channel. However, doing so immediately replaces the current media file with the file you are attempting to load.

## Adjusting On-Air Properties

The Logo tab in DashBoard allows you to adjust the position and play modes of media files. Parameters that are adjusted are saved with the image/animation. When a logo/animation is subsequently re-loaded, these parameters are also recalled. However, if there are no saved parameters for a recalled logo/animation, then the last used values are retained.

### To adjust the on-air properties of a media file

1. Load a media file as outlined in **“To load a media file into a Logo channel”**.
2. Adjust the position of a still image in the viewing area of the screen using the **X** and **Y Position** sliders.
  - ★ Full images cannot have their position adjusted.
3. Use the **Auto Play** box to set whether the animation automatically starts to play when it is taken on-air.
 

When this feature is enabled, the animation will play from the first frame when it is brought to air.
4. Use the **Looping** box to set whether the animation will start over when it reaches the last frame of the animation.
  - When this feature is enabled, the animation will cycle continuously (from the last frame back to the first) in an endless loop.
  - When this feature is disabled, the animation plays once, and freezes on the last frame. The animation will stay fixed on the first frame.
- ★ When both Auto Play and Looping are enabled, the animation begins to play on a transition, and keeps playing in an endless loop. If another transition is triggered, the animation jumps to the first frame and keeps playing in an endless loop.
5. Use the **Hold Time** menu to add a pause between loops of an animation.
  - ★ When this feature is enabled, the animation will play, but before looping back (if looping is enabled), it pauses on the last frame, for the specified Hold Time (in number of frames).
6. Select how an image is displayed by selecting an option from the **Play Mode** menu.
  - ★ The Play Mode feature only applies to Interlaced video formats and has no effect when using Progressive video formats.

## Connection using FTP

You can use an FTP connection to transfer media files to and from the Micro SD card of the MC1-UHD. You can also use an FTP client to delete images on the Micro SD card and re-name images.

Before accessing the MC1-UHD via FTP:

1. Ensure the MC1-UHD link status is valid. This information is reported in the Global > Network > Link Status field in DashBoard.
2. The default login credentials are:
  - User Name — user
  - Password — password

## Connection using RossLinq

RossLinq enables you to transfer still images directly from the XPression to a MC1-UHD Logo channel. You can transfer files into any of the directories for any of the Logo channels on the card. There are two directories, each corresponding to a specific Logo channel on the card. The file can be a format as listed in **Table 20**. Note that the transfer of animations is not supported at this time.

To connect to the XPression via RossLinq, establish an FTP connection using the following information:

- ★ The RossLinq channel in XPression must be set as a passive FTP connection in order to set up communications between XPression and the MC1-UHD. Refer to the XPression documentation for details.
  - IP Address — This information is displayed in the Global > Network > Current IP Address field in DashBoard.
  - User Name — xpression
  - Password — password
- ★ The images loaded via RossLinq are not retained after reboot of the MC1-UHD.

### For More Information on...

- using XPression, refer to the ***XPression User Guide***.

## Using the Micro SD Card

The following tips and restrictions apply when using the Micro SD card:

- the MC1-UHD must be powered down to install or remove the Micro SD card
- if you must remove the Micro SD card for programming, re-boot the MC1-UHD when you re-install the Micro SD card. This allows the MC1-UHD to recognize that a new card is available.
- the Micro SD card Status field in the **On Air Control > Logo > Logo #** tab reports how much space is available on the Micro SD card.



# Keying

Keying is the term used to describe the inserting (or electronically cutting) portions of one video source on to another (for example placing titles over background images). Keys are made up of two components: an alpha (that cuts the hole in the background video), and a fill (that fills the hole with different video). This chapter summarizes the MC1-UHD keying features and configuration options.

## Overview

The MC1-UHD includes four high quality video keyers. In addition to the external Key Video and Key Alpha source, there are also two internal static/animation play-out channels. This enables the keying of external devices such as character generators or graphic systems into a program feed and/or keying with two internal logo channels.

## Key Types

The MC1-UHD supports the following key types.

### Auto Select

An Auto Select Key uses two video signals: the Key Alpha is used to cut the hole in the video, and the Key Video is used to fill the hole. For external keying, use the Configuration > External Key options to configure the two external keys. For internal sources, the Key Video and Alpha are generated internally. Note that the Key Alpha Type is automatically set to Shaped.

### Self

A Self Key uses only one video signal: the luminance (or brightness) of the Key Video is used as the Key Alpha. For external keying, use the On Air Control > External Keys options to configure the two external keys. For internal sources, the Key Video is internally supplied. Note that the Key Alpha Type is automatically set to Unshaped.

## Key Alpha Types

You can specify a key alpha as one of the following types. The default key type is Shaped.

### Unshaped (multiplicative keying)

With an Unshaped Key, the Key Alpha luminance value mixes linearly the Key Video with the Background. Shades of gray, in the Key Alpha, are translated into transparency levels, giving the key a soft edge. Self Keys are set to Unshaped by default.

### Shaped (additive keying)

With a Shaped Key, the Key Alpha cuts a hole in the Background based on the luminance value of the Key Alpha and adds the Key Video to the Background hole. Shaped Key alphas are sometimes used with Character Generators to cut very precise holes for the Key Video fill. Auto Select keys are set to Shaped by default.

## Mapping the External Keys

Each of the two external keys can have an independent input source assigned. The External Key can then be used over top of the PGM input for each Keyer.

## To map an external key

1. Navigate to the **On Air Control** interface as outlined in **“To display the On Air Control interface in Dashboard”**.
2. Select the **External Keys** tab.

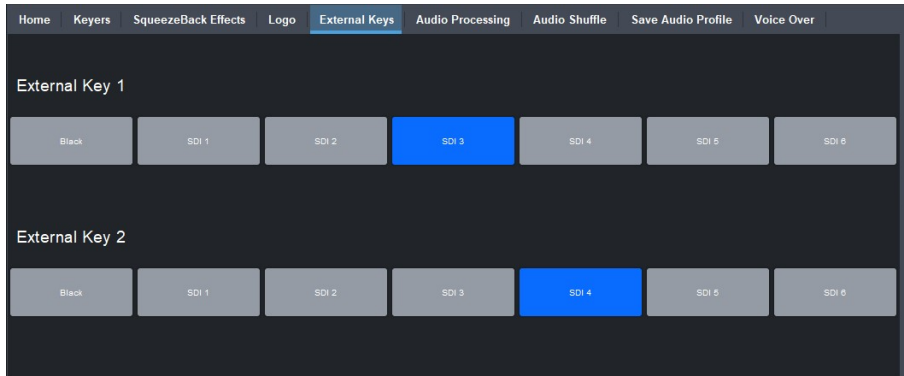

3. Locate the row for the External Key you wish to map.
4. Select an input crosspoint (the key video and, optionally, the key alpha source) from the row.
5. Repeat steps 3 and 4 for the second External Key.

## Configuring a Key

You can assign any of the logo channels as the source for a keyer. The MC1-UHD offers full key control with shaped and unshaped keying, self key or auto key, with clip and gain control.

### To configure a key

1. Ensure that you set up the logo channel(s) as outlined in **“Media File Management”**.
2. Navigate to the **On Air Control** interface as outlined in **“To display the On Air Control interface in Dashboard”**.
3. Select the **Keyers** tab.
4. Select the sub-tab for the Key you wish to configure.
5. To assign a source to a key:
  - a. Locate the **Keyer Source** area of the tab.
  - b. Select a button from the Keyer Source area to assign that source to the Key.

In the following example, the user assigned Logo 2 as the source for Key 3.

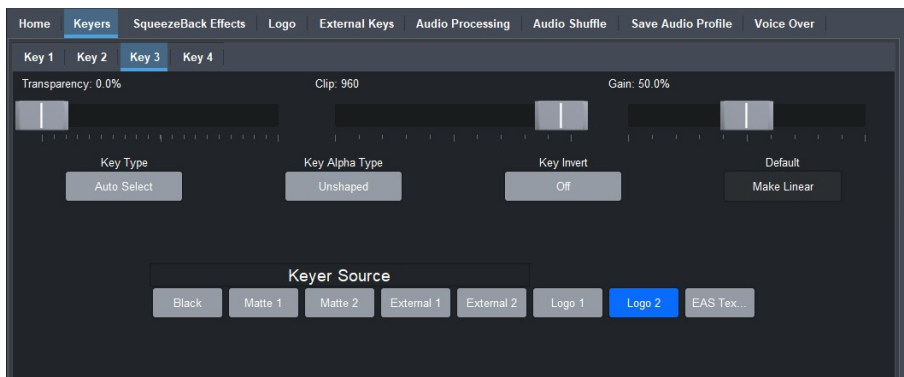

6. Set the **Key Type** by toggling the **Key Type** button.
  - **Auto Select**— A Key which uses two video signals (Alpha and Fill); the Key Alpha Type is automatically set to Shaped. If you configure an internal Logo channel as Auto Select, the associated alpha signal is used.
  - **Self** — A Key that uses the luminance values of the KEY VIDEO source for the alpha; the Key Alpha Type is automatically set to Unshaped. If you configure an internal Logo channel as Self, the luminance value of the associated alpha is used.
7. Use the **Transparency** slider to adjust the transparency level of the key.
  - **0** — The key is completely opaque; there is no difference between the original key and the key with the transparency effect applied to it.
  - **100** — The key is completely transparent; the key is not visible on the screen.
8. Use the **Clip** slider to set the threshold level between what is keyed (visible) and what is not.
9. Use the **Gain** slider to set the range of softness around the Clip threshold, which defines the transparency of the key. For shaped keys, the clip and gain should be left at their default values.
- ★ To reset the **Clip** and **Gain** values, click **Make Linear**.
10. Use the **Key Alpha Type** menu to specify the Key Alpha type. Refer to “**Key Types**” for more information on each type.
11. Click **Key Invert** to **On** to reverse the polarity of the key alpha so that the holes in the background are cut by dark areas of the key alpha instead of bright areas.



# Mattes

Mattes are solid color signals that can be applied to backgrounds and keys. A matte has only one color but can be applied to a key or to the PGM/PST buses.

## Setting up a Matte Color

Color selection is done by adjusting the luma, and two color difference signals (Cr and Cb) to create a desired color. The matte is a full raster signal.

### To set up a matte color

1. Navigate to the **Configuration** interface as outlined in **“To display the Configuration interface in DashBoard”**.
2. Select the **Matte** tab.

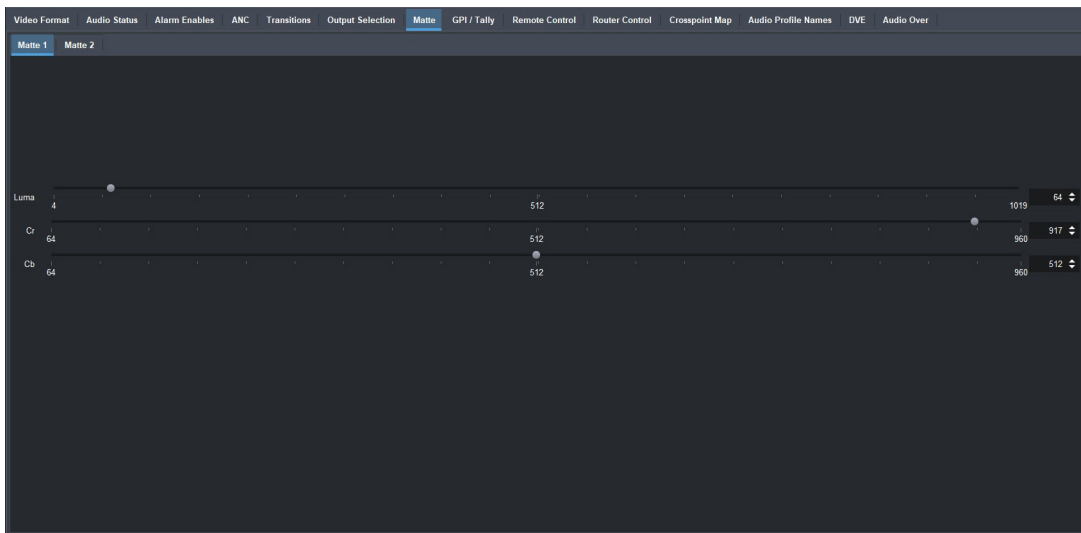

3. Select the sub-tab for the matte generator you want to configure.
4. Use the **Luma** slider to adjust the luminance of your matte color.
5. Use the **Cr** slider to adjust the red difference signal of your matte color.
6. Use the **Cb** slider to adjust the blue difference signal of your matte color.
7. Repeat steps 3 to 6 for the second matte generator if required.



# Transitions

Transitions are used to change the background video and take keys on and off-air. A transition can include any combination of Background video, keys, and audio.







## Before You Begin

Keep the following in mind when performing transitions:

- To allow for audio cross fading, a cut takes two frames. One frame is used for the audio fade down, the video is then cut, followed by the one frame audio fade up.
- The speed at which the transition is performed, in number of frames, is determined by the setting (Slow, Medium, or Fast) in the Transition Rate area.
- If a crosspoint or transition button is selected while a transition is in progress, the original transition continues as subsequent button presses are ignored (except the FTB button).
- When you are performing a transition, or keying, the embedded audio is carried in the ancillary data of the background video signal. The ancillary data from the background source is replaced with the ancillary data from the preset source, and the ancillary data for keyed sources is stripped.

## Transition Types

The **Transition Type** area of the **On Air Control** interface includes the following buttons:

-  (Cut) — Select this button to perform a cut transition from one source to the next.
-  (V-Fade) — Select this button to perform a V-Fade transition from the Program source to Black to the next source.
-  (Cut-Fade) — Select this button to perform a cut to black, then fade up to the next source.
-  (Cross Fade) — Select this button to perform a gradual fade from one source to the next. Note that this button is selected after performing a factory default reset.
-  (Fade-Cut) — Select this button to fade from one source to black and then cut to the next source.
-  (SqueezeBack) — Select this button to perform a SqueezeBack effect by reducing the size of the video over time to the dimensions set in the Squeeze Effects tab. You may change your background or keys on-air with this transition type. The MC1-UHD-DVE-1CH-LICENSE is required.

## Configuring the Transition Buttons

The Configuration interface in DashBoard enables you to specify how the **TAKE** button, in the On Air Control tab, behaves when toggled during a transition.

### For More Information on...

- the **GPI Overrides TAKE** feature, refer to “**Enabling GPIs to Override Take Transitions**”.

### To configure the TAKE button

1. Display the **Configuration** interface as outlined in “**To display the Configuration interface in DashBoard**”.
2. Select the **Transitions** tab.

- Configure the **TAKE** button behavior by choosing an option from the Take During Transition Action area. Choose from the following:

★ The selected behavior also applies to GPIOs.

- **Ignore** — Select this option to disregard any successive presses of the **TAKE** button until the transition is complete. This is the default setting.
  - **Pause** — Select this option to pause the transition when the **TAKE** button is toggled, and resume the transition when the button is pressed again.
  - **Reverse** — Select this option to reverse the transition back to the start.
- Select the **Cut on Clean Feed** option to automatically perform a cut transition from one Clean Feed source to the next.

## Specifying a Transition Rate

You can independently define the Fade to Black, Slow, Medium, and Fast transition rates, in number of frames.

### To set a transition rate

- Navigate to the **On Air Control** interface as outlined in “**To display the On Air Control interface in Dashboard**”.



- Specify the rate, in number of frames, as required in the **Slow Rate**, **Medium Rate**, and **Fast Rate** fields.
- Use the **FTB Rate** field to specify the Fade to Black transition rate.

## Auto Swapping of Program and Preset Buses

You can choose to have the Program and Preset bus flip-flop after a transition (default setting), or have the Preset bus unchanged after a transition.

### To swap the buses after a transition

- Navigate to the **Configuration** interface as outlined in “**To display the Configuration interface in Dashboard**”.
- Select the **Transitions** tab.



3. Choose one the following **Post Transition Behavior** options:
  - Leave Preset As Is — The Preset bus is unchanged after a transition. Preset keyers follow Program keyers on hot-punches.
  - Swap Program/Preset — The selections for the Program and Preset swap. This is the default setting.
  - Preset Off — The keyers on the Preset bus will be turned off automatically after a transition.

## Resetting the Audio Gain Level After a TAKE Transition

The Reset Audio Gain option enables you to specify the audio gain level is reset, to the factory default value of 0dB during TAKE transitions. When enabled, this option ramps the audio gain level to the default level as the Preview bus is transitioned. When disabled, this option keeps the audio gain level at the current level after the transition completes (the audio gain is not adjusted).

### To reset the audio gain level after a TAKE transition

1. Navigate to the **Configuration** interface as outlined in **“To display the Configuration interface in Dashboard”**.
2. Select the **Transitions** tab.
3. Select the **Reset Audio Gain** box to reset the audio gain level after a transition.

## Performing Transitions

You can perform transitions in one of the following manners:

- hot-punching a crosspoint on the Program or Preset bus
- selecting a Keyer button from the Keyer area to transition a keyer on/off air
- using the options in the Transition area to add elements to the transition

The speed at which the transition is performed, in number of frames, is determined by the Transition Rate (Slow, Medium or Fast) set in the Home > Transition Rate menus.

### For More Information on...

- the transition area and buttons of the On Air Control interface, refer to **“Control Panel”**.

### To perform a Cut transition on the Program bus

1. Navigate to the **On Air Control** interface as outlined in **“To display the On Air Control interface in Dashboard”**.
2. Select a button on the Program bus.

### To perform a Cut transition for a Key

1. Navigate to the **On Air Control** interface as outlined in **“To display the On Air Control interface in Dashboard”**.
2. Select a source for the Program output from the desired Key **Source** menu.
3. Click .
4. Click **TAKE**.

The Key is transitioned on or off air.

The **Key Status** field(s) indicates the on-air status of the key.

### To perform a Take transition

1. Navigate to the **On Air Control** interface as outlined in “**To display the On Air Control interface in DashBoard**”.
2. Select the **Key 1-4** buttons to add the required corresponding keyer(s).
3. Select a **Transition Speed** button (Slow, Medium, or Fast).
4. Select a **Transition Type** button.
5. Click **TAKE**.

## Performing a Fade to Black

The **FTB** button performs a fade to black where the:

- program bus is faded to black at the FTB rate,
- audio fades to silence, and
- closed captioning information is not passed.

The Fade to Black rate is set in the **Home** tab as outlined above. When the **FTB** button is selected, the MC1-UHD performs an Auto transition to black.

★ If the **FTB** button is grayed out, the Configuration > Transitions> FTB Disabling > FTB Button option is set to FTB Disabled.

### To perform a fade to black

1. Navigate to the **On Air Control** interface as outlined in “**To display the On Air Control interface in DashBoard**”.
2. Toggle the **FTB** button as follows:
  - When the button is lit red, clicking it performs an Auto transition to black. The rate is determined by the rate set in the Home > FTB Rate menu.
  - When the button is not lit red, clicking it performs an Auto transition from black. The rate is determined by the rate set in the Home > FTB Rate menu.

## Automation Switch Request

When the MC1-UHD interfaces with an Automation System via the Presmaster protocol, you can choose how the MC1-UHD defines automation switch requests. This feature applies to the Program bus, Preset bus, and external sources. Ensure the **ATMN** button is toggled to **ON** to enable your automation device to control the MC1-UHD. This button is located on the **On Air Control** interface.

### For More Information on...

- setting up communications via the Presmaster protocol, refer to “**Using the Presmaster Protocol**”.

### To define the automation switch requests

1. Navigate to the **Configuration** interface as outlined in “**To display the Configuration interface in DashBoard**”.
2. Select the **Remote Control** tab.
3. Locate the Presmaster area of the tab.
4. Click **Device Setup**.

The Presmaster control dialog opens.

5. From the **Automation Switch Request** area, select how a crosspoint switch is defined:
  - **Router Crosspoint** — The received value refers to a physical or virtual router crosspoint. This is the default setting.
  - **Button Number** — The received value refers to a specific MC1-UHD crosspoint button on the DashBoard control panel. Note that these crosspoint buttons are defined in the **Crosspoint Map** tab.



# SqueezeBack Effects

The MC1-UHD can be used to perform on-air 2D DVE (SqueezeBack) transitions to reveal another video source or graphic. You can also transition to pre-squeezed effects with standard transitions, squeeze in any direction on either X or Y axis, or both. Four DVE presets are provided for quick effect recalls on the fly. This chapter outlines the DVE feature and SqueezeBack Effects options of the MC1-UHD.

★ The MC1-UHD-DVE-1CH-LICENSE is required.

## SqueezeBack Effects Controls

This section briefly outlines the elements of the On Air Control interface for the SqueezeBack Effects feature.

**For More Information on...**

- the DVE tab in the Configuration interface, refer to “DVE Tab”.



Figure 21 SqueezeBack Effects Controls

### 1. SqueezeBack Effects Tab

The SqueezeBack Effects tab provides a sub-tab for each of the four SqueezeBack presets, enabling you to customize each effect separately. From these sub-tabs you can specify the horizontal and vertical positions of the image on the screen, and the reveal source from the four logo channels or an external video source. Because the reveal source shares the same sources available to the keyers, we encourage users to avoid sharing a source between keyer and reveal operation.

### 2. Effect Select Area

This area includes the Effect # status field and an **EFFECT SELECT** button. The status field reports the last applied effect and whether it is on or off air, or currently on the Preset Bus.

While the squeeze effect is on air:

- › the **EFFECT SELECT** button is locked. Even though you can still adjust the options in the SqueezeBack Effects tabs, we suggest not doing so since all effect changes are immediately applied.

- › you are able to change the background with a transition and you can hot-punch a source or key on the Program bus. However, hot-punching a source on the Program bus will take the squeeze effect off air. Hot-punching keys on/off will not take the squeeze effect off air.
- › you can perform any hot-punch or **TAKE** transition inside of the squeeze effect.

### 3. SqueezeBack Effect Transition Type Button

Selecting this button performs a SqueezeBack effect with the transition. You must pre-configure your SqueezeBack presets, then select the preset you want to apply to the transition before executing your transition. For information on the other types of transitions, refer to the chapter “**Transitions**”.

### 4. SQUEEZE Button

Selecting this button applies the squeeze effect (as specified using the **EFFECT SELECT** button) to the next transition.

The **SQUEEZE** Include button is selected (lit) and locked out as long as the transition type is Squeeze. The **SQUEEZE** Include button is not unlocked until you select another transition type, at which time the previous state of **SQUEEZE** Include button is restored.

You can de-select the **SQUEEZE** Include button while an effect is on air to perform a transition inside the squeeze effect.

## Working in 2D Space

In order to maximize the features of the SqueezeBack feature, it helps to have a basic understanding of two-dimensional (2D) space. Two axes (X and Y) are used to define 2D space. The position of an image on each of the two axes determines its location in 2D space.

- X — Refers to the horizontal (left-right) position of the image on the screen.
- Y — Refers to the vertical (up-down) position of the image on the screen.

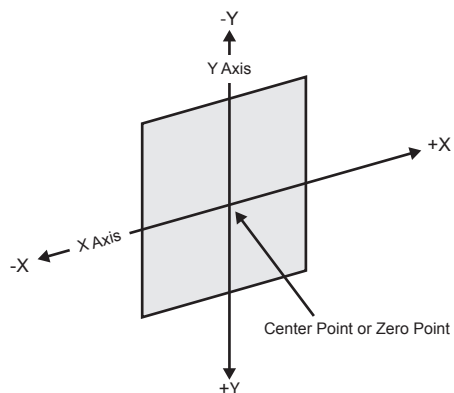

Figure 22 Basics of 2D Space

### Image Position in 2D Space

The center point of the screen is the center (zero) point. Each axis has a positive and negative region.

- Moving an image to the left of the center (or zero) point locates it in -X space.
- Moving an image to the right of the center locates it in +X space.
- Moving an image below the center point locates it in +Y space.
- Moving an image above the center point locates it in -Y space.

When working with images, keep in mind that the 2D space extends beyond the visible area of the screen. Images can be positioned and manipulated outside of the viewable area to create some

interesting effects. For example, an image can be positioned in such a way that it appears to roll into view from a point outside the screen and roll out of view on the other side.

## Configuring the DVE Transition Options

The MC1-UHD can be used to perform on-air SqueezeBack transitions to reveal another video source or graphic. If

you wish to include a SqueezeBack with your transitions, you must first specify the key order using the DVE located in the Configuration interface.

### Specifying the Key Order

You can select the SqueezeBack point in the mixer tree. There are five possible options. This setting is applied to all SqueezeBacks.

#### To specify the key order of the SqueezeBacks

1. Navigate to the **Configuration** interface as outlined in **“To display the Configuration interface in DashBoard”**.
2. Select the **DVE** tab.
3. Locate the **Included in SqueezeBack** area.
4. Specify the key order by selecting one of the following:
  - **Background Only** — includes only the background in the SqueezeBack effect. This is the default.
  - **After Key 1** — Key 1 is included in the squeeze effect. Keys 2 to 4 are excluded.
  - **After Key 2** — Keys 1 and 2 are included in the squeeze effect. Keys 3 to 4 are excluded.
  - **After Key 3** — Keys 1 to 3 are included in the squeeze effect. Key 4 is excluded.
  - **After Key 4** — All keys are included in the squeeze effect.
5. Use the **Background in Fade** options to specify the reveal source during a V-fade type transition inside an already squeezed image on the PGM bus. Choose from the following:
  - **Background** — allows the reveal source background to pass through.
  - **Black** — allows the reveal source background to fade to complete black.

## Configuring a SqueezeBack Preset

This section outlines how to configure Preset Effect 1 in preparation of including it in a transition. The same procedure can be used to configure any of the effect presets for your MC1-UHD.

#### For More Information on...

- the menu options when configuring your SqueezeBack presets, refer to **Table 55**.

#### To configure an effect

1. Navigate to the On Air Control interface as outlined in **“To display the On Air Control interface in DashBoard”**.
2. Select the **SqueezeBack Effects** tab.
3. Select the **Effect 1** tab to configure the first effect.
4. To specify the position of the image in the viewing area of the screen:
  - a. Use the **X Position** slider to adjust the horizontal position of the image on the screen.
  - b. Use the **Y Position** slider to adjust the vertical position of the image on the screen.

5. To squeeze the image appearance:
  - a. Use the **X Size** slider to squeeze horizontally.
  - b. Use the **Y Size** slider to squeeze vertically.
6. Select the **Lock Aspect Ratio** check box to squeeze in both directions at the same time.
- ★ You can reset the image to the default image settings by clicking **Reset to Defaults**.
7. In the **Reveal Source** area, select the video source the squeeze effect will reveal.

## Performing Transitions with SqueezeBack Presets

This section provides examples of performing transitions with SqueezeBack Presets. Your requirements may differ from what is presented here.

### Notes on Performing Transitions with SqueezeBack Presets

Keep the following in mind when performing transitions with SqueezeBack presets:

- You can pre-define up to four different SqueezeBack Presets (Effects 1-4)
- A squeeze effect does not consume any existing keyers and you can specify any of the logo channels to use as a reveal source for that effect.
- Hot-punches on the Program bus can be performed within an on air squeeze effect. The hot-punch is carried out inside of the squeeze effect. The squeeze effect remains on air.
- Squeeze effect transitions are also supported under the Presmaster automation protocol.
- You can also trigger a squeeze effect using a GPI trigger.
- You can configure a tally to raise when the reveal source is visible. This tally will be raised regardless of the configured source. This can be used in cases when a graphics station is providing the video and needs to know when to trigger the playing of an animation.
- Selecting the Constrain to Screen box in the SqueezeBack Effects tab will enable "snap-back" on the X, Y position controls to ensure the squeezed image remains entirely on screen.

## Previewing a Squeeze Effect

You can preview your Effect preset on the Preview monitor without affecting the Program bus. However, any time a squeeze effect is on air, the preview output is not scaled correctly.

### To preview a squeeze effect

1. Set up your effect as outlined in **"To configure an effect"**.
2. Navigate to the On Air Control interface as outlined in **"To display the On Air Control interface in Dashboard"**.
3. Use the **EFFECT SELECT** button to specify the desired squeeze effect for the transition.
4. Select the **SQUEEZE** button.

## Transitions with SqueezeBack

This section provides examples of executing transitions that include SqueezeBack Preset.

### Basic Transition with a Squeeze Effect

*Operation:* This is a SqueezeBack transition.



1. Set up your effect using the tabs in the SqueezeBack Effects tab as outlined in the section **"Performing Transitions with SqueezeBack Presets"**.
2. Use the **EFFECT SELECT** button to specify the desired squeeze effect for the transition. This is the effect that you configured in step 1.
3. Select  in the **Transition Type** area.  
The Effect # status field now indicates ON PST. You can preview the squeeze dimensions on your Preview monitor.
4. Select the **SQUEEZE** button.
5. Select **TAKE**.

## Dissolve to a Static Squeeze Effect

*Prerequisite:* You have a pre-squeezed effect ready on Preview.

*Description:* When you select **TAKE**, the Program dissolves to the pre-squeezed effect. After you have set up the transition, and during the transition, the Preview monitor is scaled correctly.

*Operation:*

1. Select the **EFFECT SELECT** button to specify the desired squeeze effect for the transition.
2. Select a dissolve transition type (Fade-Fade, Take-Fade).
3. Ensure the **SQUEEZE** button is selected.

The Preview monitor shows the squeeze effect.



# Ancillary Data

Ancillary Data (ANC) is the non-video data that can be embedded within the SDI signal, such as audio, audio metadata, timecode, closed caption data, AFD, and payload identification. This chapter provides an overview of ANC support on the MC1-UHD.

## Supported Data Types

This section provides information on the data types that the MC1-UHD manages.

### Compressed Audio Metadata

Compressed Audio Metadata can be passed or deleted as follows:

- If the input is not synchronous to the output, select **Action > Delete** in the **ANC Settings** sub-tab.
- If converting between progressive and interlaced formats, select **Action > Delete** in the **ANC Settings** sub-tab.
- If the input is not synchronous to the output, data will be dropped (but not duplicated<sup>1</sup>) as part of the frame sync behavior.

### Other Packets

All remaining packets can be passed or disabled. When pass is enabled, the packets will be inserted in VANC on the specified line in the same order as they were received. If they do not fit on the specified line, they will continue on the next line. Approximately up to 250 packets, or 1500 bytes of data, can be passed this way.

## Specific ANC Processing

Use the options in the **ANC** tab to define how ancillary data is inserted in the output when HANC and/or VANC pass through is disabled.

★ For each packet type the user can control the insertion position.

### To configure the processing of specific ANC types

1. Navigate to the **Configuration** interface as outlined in **“To display the Configuration interface in DashBoard”**.
  2. Select the **ANC** tab.  
The **ANC** sub-tab is automatically selected.
  3. For each packet, specify how the card processes the ANC data by selecting an option from the **Action** area.
  4. Use the **Insertion Line** menu to select a line to insert the specified ANC packet on. The default is 12 for each packet. Note that all packets are inserted in VANC, except for timecode in non-SD formats which are inserted in the HANC.
- ★ If more than one packet is to be inserted in the same line, the packet with the lowest insertion order number will be inserted first.
5. Use the **Insertion Order** menu to define the hierarchy of the packets insertion.
- ★ The lower the number, the higher priority the packet is given. For example, by default, the AFD packet is set to be inserted first (5), and Compressed Audio Metadata is inserted fourth (4).

6. If the Output Format is set to 480i 59.94Hz, use the **Line 21 Caption Pass-through** option to specify to pass closed-captioning or other data, through unaltered on Line 21.

★ The **Line 21 Caption Pass-through** option should only be used when ancillary data is present on Line 21.

## Monitoring the Encoding and Decoding of ANC Data

The MC1-UHD provides the ability to monitor the encoding or decoding of ANC data on SDI signals.

### To verify that the MC1-UHD is decoding ANC data

1. Navigate to the **Configuration** interface as outlined in “**To display the Configuration interface in Dashboard**”.
2. Select **ANC > Decode**.
3. Select the sub-tab for the SDI port you want to monitor.
4. Select the **Alarm Enable** box for an ANC Data type to enable an alarm condition to display when an error is detected.

### To verify the MC1-UHD is encoding ANC data

1. Navigate to the **Configuration** interface as outlined in “**To display the Configuration interface in Dashboard**”.
2. Select **ANC > Encode**.
3. Select the sub-tab for the SDI port you want to monitor.
4. Select the **Alarm Enable** box for an ANC Data type to enable an alarm condition to display when an error is detected.

# Configuring the GPI/Tallies

This chapter outlines how to configure each GPI/Tally independently on the MC1-UHD.

## GPI Communication Setup

When configured as a GPI, a port behaves as an input, and can be used to trigger actions such as Cut/Dissolve the Key and/or Background. A push-button switch, or an ON-OFF switch, may be directly connected between the port and the adjacent ground pin. Alternatively, an external device may drive a low level. Minimum pulse duration is 1ms, anything shorter will be filtered out.

Typically, users will configure the GPI for Edge trigger. This means that the action is carried out either on the falling edge (button is pushed), or rising edge (button is released), depending on which Polarity is selected. Alternatively, users may configure the GPI for Level trigger. In this mode, the action is carried out on both the rising and falling edges, so there are effectively two states. The Polarity control can be used to invert the behavior. Regardless of the trigger type, GPI commands may be overridden by other command inputs such as serial protocols.

★ RossTalk GPI commands will trigger functions assigned in the GPI setup.

The **Edge** option enables the GPI to act as a latching trigger. Edge triggers are used when you want to toggle between settings. This option enables the GPI to execute a specific function.

- If configured for Falling Edge, the selected function is executed when the GPI input signal transitions from High to Low.
- If configured for Rising Edge, the selected function is executed when the GPI input signal transitions from Low to High.
- Edge triggered GPI signals are sampled once per frame and the associated function is executed only once per frame. The minimum pulse width is 1 millisecond.
- Typically, the edge triggered GPI is driven by external equipment that generates one pulse per event.

**Level** triggers are used when you want to assert a particular state for a setting. You define the on-air state of the function as being either Level High or Level Low. Therefore, if the on-air state of the Key is defined as Level High for example, when the GPI is a Level High signal, the Key will stay on air. If a Level Low is received, the Key will be taken off air.

- If configured for Active Low, the selected function is executed when the GPI input signal is driven Low.
- If configured for Active High, the selected function is executed when the GPI input signal is driven High.

## Configuring a Port as a GPI

Each GPI can be configured independently from the others, allowing you to customize the function of each connection.

★ The number of available GPIO ports depends on the rear module you are using. The R3B-GATOR (8322AR-318D) and R3A-GATOR (8322AR-319C) each provide 6 GPIO ports. The R4-GATOR (8323AR-325) provides 4 GPIO ports.

### To configure a port as a GPI

1. Navigate to the **Configuration** interface as outlined in **“To display the Configuration interface in DashBoard”**.
2. Select the **GPI/Tally** tab.

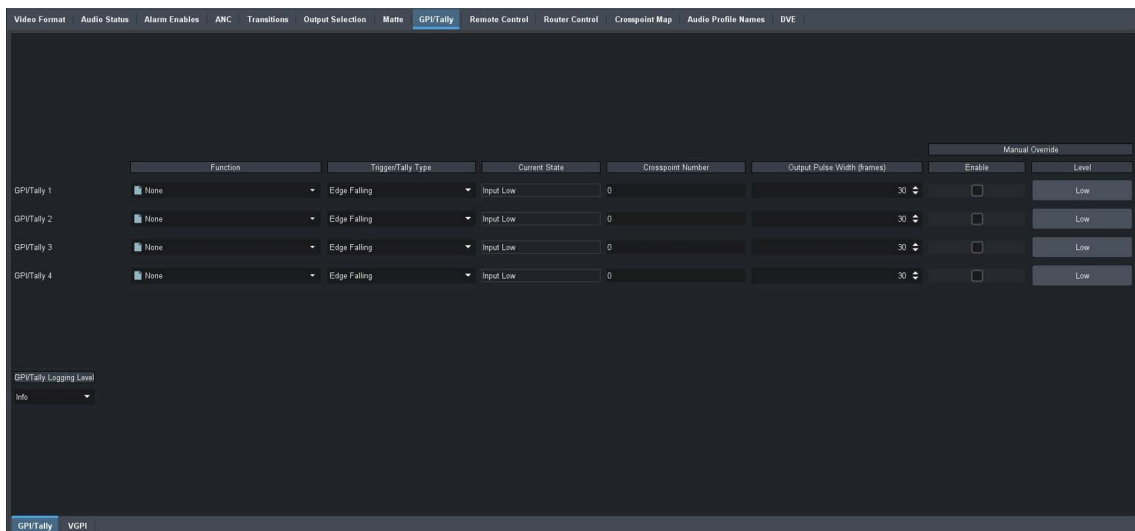

3. Use the **Function** menu to assign a transition event to a specific GPI port.
4. Use the **Trigger/Tally Type** menu to select a trigger and polarity for the GPI.
5. If the **Trigger/Tally Type** is set to **Falling** or **Rising**, use the **Output Pulse Width** menu to specify the number of frames the pulse will be for an edge trigger.
6. If the **Function** is set to **GPI PGM XPT**, use the **Crosspoint Number** field to specify the crosspoint on the MC1-UHD that will trigger the GPI.

The crosspoint number can be either a router source or a button number, as determined by the Remote Control > Device Setup > Switch Request setting.

7. Use the **Manual Override** and **Level** options in conjunction to override a GPI. This allows a GPI to be manually triggered from the menu and is useful for testing GPI function.
  - a. Select the **Manual Override** box for a GPI/Tally.
  - b. Toggle the **Level** button.

## Tally Communication Setup

When configured as a Tally, a port becomes an output, providing a status indicator. Typically this is used to indicate which input(s) are on-air at any given moment. Each tally output on the card can be configured to be active when any of the six inputs are on air. They can be configured as Active High or Active Low. Edge triggered tallies generate a pulse to the configure polarity (high or low) for a duration of 30 frames or the duration of the event (whichever is shorter). The tally outputs defaults to a logical high level when inactive. When the tally becomes active, for example the signal is on-air, then the output is driven low.

- ★ The number of available GPIO ports depends on the rear module you are using. The R3B-GATOR (8322AR-318D) and R3A-GATOR (8322AR-319C) each provide 6 GPIO ports. The R4-GATOR (8323AR-325) provides 4 GPIO ports.

### To configure a port as a tally

1. Navigate to the **Configuration** interface as outlined in **“To display the Configuration interface in Dashboard”**.
2. Select the **GPI/Tally** tab.
3. Use the **Function** menu to specify what will drive the tally output when the input is on-air.
4. If the **Function** is set to **Tally PGM XPT**, use the **Crosspoint Number** field to specify the crosspoint on the MC1-UHD that will trigger the tally.

The crosspoint number can be either a router source or a button number, as determined by the Remote Control > Device Setup > Switch Request setting.

5. Use the **Trigger/Tally Type** menu to select the polarity of the tally.
6. If the **Trigger/Tally Type** is set to **Falling** or **Rising**, use the **Output Pulse Width** menu to specify the number of frames the pulse will be for an edge trigger.
7. Use the **Manual Override** and **Level** options in conjunction to override a tally. This allows a tally to be manually triggered from the menu and is useful for testing tally function.
  - a. Select the **Manual Override** box for a GPI/Tally.
  - b. Toggle the **Level** button.

## Enabling GPI/Tally Logging

The MC1-UHD can provide a log of commands received from downstream devices via the GPI/Tally ports. You can specify the type of events to monitor. Events are listed in a hierarchical order based on the selected severity including internal errors and unrecognized or invalid responses from the GPI/Tally port, failed communications between the MC1-UHD (such as time outs) and the device connected to the GPI/Tally port. This is intended for troubleshooting incompatibilities between the MC1-UHD and downstream devices.

### To configure the GPI/Tally logging feature

1. Navigate to the **Configuration** interface as outlined in “**To display the Configuration interface in DashBoard**”.
  2. Select the **GPI/Tally** tab.
  3. Use the **GPI/Tally Logging Level** menu to specify the type of events to log.
- ★ By default, the logging level is set to **Info** which enables the MC1-UHD to provide a summary of all commands sent to and responses via this GPI/Tally port.

## Enabling GPIs to Override Take Transitions

The MC1-UHD can be configured to prevent GPI-triggered keys from being taken off-air by a TAKE transition. On activation, this feature disables the corresponding key on the preset bus. Note that the key can still be taken off-air by a hot-punch.

### To enable GPIs to override Take transitions

1. Navigate to the **Configuration** interface as outlined in “**To display the Configuration interface in DashBoard**”.
2. Select the **Transitions** tab.
3. Select the **GPI Overrides TAKE** box.

## Using VGPIs

The Virtual GPI (VGPI) functionality of the Miranda™ Presmaster Automation or RossTalk protocols can be used to trigger squeeze on/off transitions on the MC1-UHD using a specified SqueezeBack preset. This section outlines how to assign a VGPI to a SqueezeBack preset.

### For More Information on...

- the Presmaster commands, refer to the Miranda™ Presmaster Automation Protocol documentation.
- the Presmaster commands the MC1-UHD supports, refer to “**Using the Presmaster Protocol**”.

- the RossTalk protocol commands the MC1-UHD supports, refer to “Using RossTalk”.
- the options in the VGPI tab, refer to “VGPI Tab”.
- the location of the **ATMN** button on the On Air Control interface, refer to “Menu System Basics”.

## Assigning a SqueezeBack Preset to a VGPI

You can assign one of sixteen Virtual GPIs (VGPIs) to a specific SqueezeBack preset. Note that these VGPIs are not associated with the physical GPIO ports on the rear module.

### To assign a SqueezeBack Preset to a VGPI

1. Navigate to the **Configuration** interface as outlined in “To display the Configuration interface in Dashboard”.
2. Select the **GPI/Tally** tab.
3. Select the **VGPI** sub-tab.

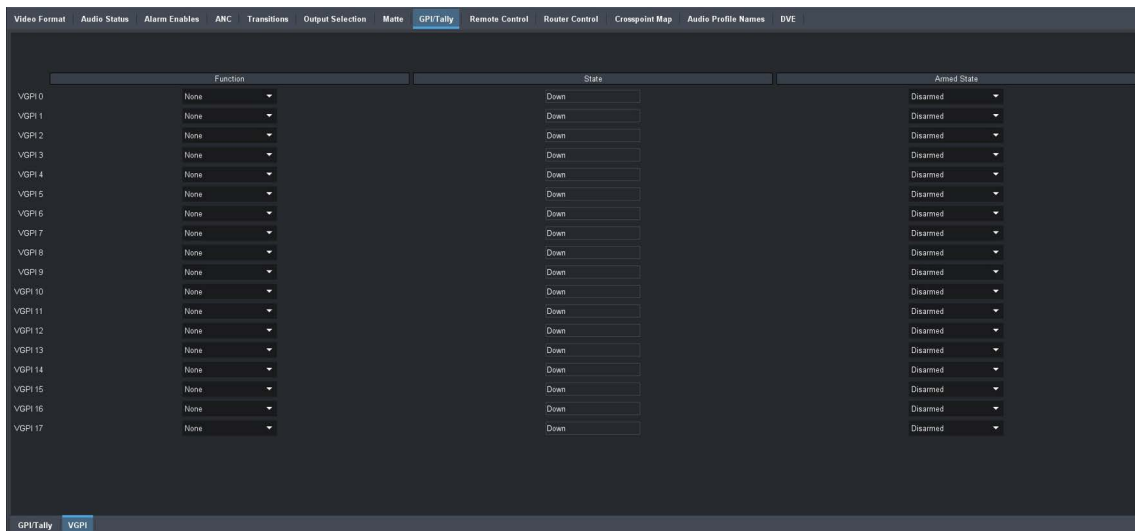

4. Use the **Function** menu to assign a specific SqueezeBack Preset for each VGPI.
5. Use the **Armed State** menu to determine if the specified SqueezeBack Preset is included in the transition. Choose from the following:
  - **Disarmed** — the command excludes the specified SqueezeBack Preset in the transition (the SQUEEZE button is unlit on the On Air Control interface). This command will be ignored when the specified SqueezeBack Preset is on Program.
  - **Armed Up** — the command includes the specified SqueezeBack Preset in the transition (the SQUEEZE button is lit on the On Air Control interface). This command will be ignored when the specified SqueezeBack Preset is on Program.
  - **Armed Down** — the command excludes the specified SqueezeBack Preset in the transition (the SQUEEZE button is unlit on the On Air Control interface). This command will be ignored when the specified SqueezeBack Preset is on Program.
6. Ensure the **ATMN** button is toggled to **ON** to enable your automation device to control the MC1-MK. This button is located on the On Air Control interface.



# Upgrading the Software

The MC1-UHD can be upgraded in the field via Dashboard.

- ★ During a software upgrade, the MC1-UHD may be unresponsive and there will be interruptions to signal flow. Ensure the MC1-UHD is bypassed in your signal path prior to performing a software upgrade.

## To upgrade the software on a card

1. Contact Ross Technical Support for the latest software version file.
  2. Ensure the Ethernet cable is connected to the **ETHERNET** port on the openGear frame.
  3. Ensure the network settings on the MC1-UHD are valid.
  4. From the **Tree View**, expand the node for the MC1-UHD you want to access.
  5. Double-click the **Global** sub-node to display the interface in the right-half of Dashboard.
  6. Click **Upload**, located near the bottom of the interface, to display the **Select file Upload** dialog.
  7. Navigate to the **\*.bin** file you want to upload.
  8. Click **Open**.
  9. If you are upgrading a single card:
    - a. Click **Finish** to start the upgrade.
    - b. Proceed to step 11.
  10. If you are upgrading multiple cards:
    - a. Click **Next >** to display the **Select Destination** menu. This menu provides a list of the compatible cards.
    - b. Specify the card(s) to upload the file to by selecting the check box(es) for the cards you want to upload the file to.
    - c. Verify the card(s) you want to upload the file to. The **Error/Warning** fields indicate any errors, such as incompatible software or card type mismatch.
    - d. Click **Finish**.
  11. Monitor the upgrade.
    - An **Upload Status** dialog enables you to monitor the upgrade process.
    - Notice that each card is listed in the dialog with a  button. This button is replaced with a **Reboot** button once the software file is loaded to that card.
- ★ Avoid clicking the individual Reboot buttons until all cards have successfully completed the file upload process and the OK button, located in the bottom right corner of the dialog, is enabled.
    - Click **OK** to reboot all the cards listed in the **Uploading to Selected Devices** dialog.
    - The **Reboot Confirm** dialog displays, indicating the number of cards that will reboot. Click **Yes** to continue the upgrade process. Note that clicking **Cancel** or **No** returns you to the **Uploading to Selected Devices** dialog without rebooting the card(s).
    - The card(s) are temporarily taken off-line during the reboot process. The process is complete once the status indicators for the **Card State** and **Connection** return to their previous status.

## Notes on Rebooting the Card

The following parameters are saved and recalled when the MC1-UHD reboots:

- All editable parameters on the Global and Configuration interfaces
- The on-air setup should be recalled.
- The Program and Preset bus selection
- The External Key crosspoint selection.
- The Transition setup including Rates, Speed, and Trans Type
- Keyer configurations (such as source, transparency, etc.)
- Logos are reloaded
- The SqueezeBack effects and the Selected Effect are reloaded

The following on-air states are not recalled:

- Keyer on-air state (Program and Preset)
- Transition includes (BKGD, Squeeze)
- Audio Over state
- Fade to Black state

# DashBoard Interface Overview

This chapter summarizes the interfaces, and tabs available from DashBoard for the MC1-UHD.

★ An asterisk beside a parameter indicates that it is the default value.

## Global Interface

The Global interface is displayed by double-clicking the Global sub-node in the MC1-UHD tree.

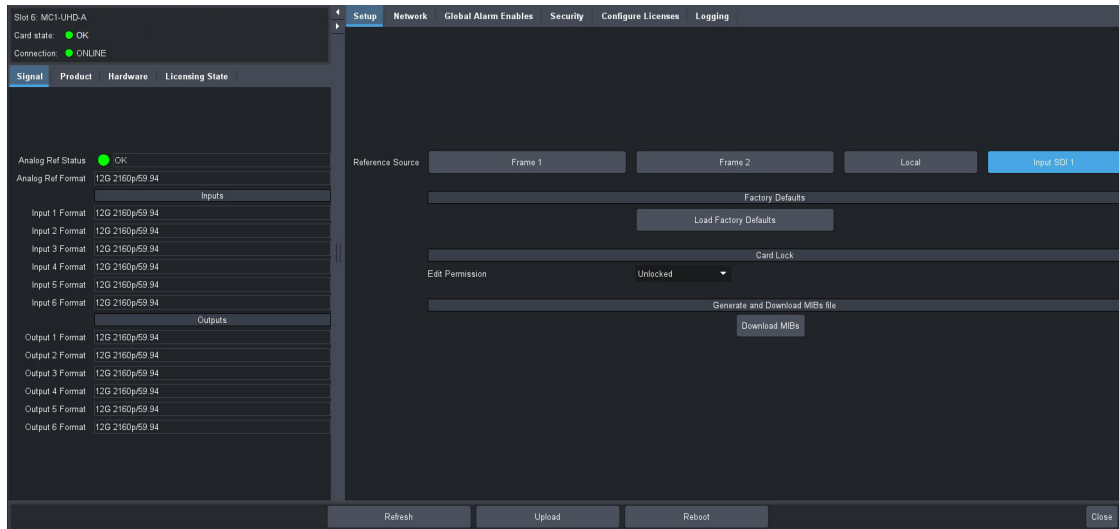

Figure 23 Example of the Global Interface in DashBoard

★ If the Global Interface does not display as shown in **Figure 23**, the network settings of the MC1-UHD may be incorrectly set or invalid. Refer to “**Getting Started**” for details.

## Signal Tab

**Table 21** summarizes the read-only information displayed in the Signal tab.

**Table 21** Signal Tab

Item	Parameters	Description
Analog Ref Status	OK (Green)	The detected reference format is supported
	Alarm Suppressed (Green)	An unsupported reference format is detected but the Global Alarm Enables > Reference Format option is disabled (box is not selected)
	Unlocked (Red)	A reference signal is detected but the MC1-UHD is not locked to it
	Unsupported (Red)	A reference signal is detected but the format is not supported by the MC1-UHD
	Incompatible (Red)	A reference signal is detected but the format is incompatible with the current output mode
Analog Ref Format	###	Indicates the detected reference format
<b>Inputs</b>		

**Table 21 Signal Tab**

Item	Parameters	Description
Input # Format	###	Signal present and the format matches the video output format configuration of the card
<b>Outputs</b>		
Output # Format	###	Reports the format of the specified video output

## Product Tab

**Table 22** summarizes the read-only information displayed in the Product tab.

**Table 22 Product Tab**

Item	Parameters	Description
Product	MC1-UHD	
Supplier	Ross Video Ltd.	
Board Rev	#	Indicates the hardware version
Serial Number	#	Indicates the serial number of the card
Rear Module	#	Indicates the rear module the card is installed in
Rear Module Status	OK (Green)	A supported rear module is installed with the card
	Alarm suppressed (Green)	An unsupported rear module is installed but the Global Alarm Enables > Rear Module option is disabled (box is not selected)
	Incomp I/O Module (Red)	Card is connected to an unsupported rear module
Software Rev	v#.#-#	Indicates the software version running on the card
Firmware Rev	##	Indicates the firmware version running on the card
CPLD Rev	##	Indicates the complex programmable logic device version of the MC1-UHD
<b>Daughter Card</b>		
Type	#	Indicates the daughter card model installed on the main card
Variant	#	
Issue	#	Indicates the hardware version of the daughter card

## Hardware Tab

**Table 23** summarizes the read-only information displayed in the Hardware tab.

**Table 23 Hardware Tab**

Item	Parameters	Description
Hardware Status	OK (Green)	The fans are operating correctly and no errors are detected
	Alarm suppressed (Green)	There are fan errors detected but the Global Alarm Enables > Fan Speed option is disabled (box is not selected)
	Critical Temperature (Red)	An error with the fans is occurring. Verify that the fans and airflow for the card is valid.
	Fan Off/Stalled (Red)	
Voltage (mV)	#	Measured input voltage
Current (mA)	#	Current consumption in milliamperes
Power (W)	#	Power consumption in watts
FPGA Temp (C)	#C	<p>Indicates the FPGA Core temperature where:</p> <ul style="list-style-type: none"> <li>• A green indicator displays when the temperature is less than 95°C.</li> <li>• A yellow indicator displays when the temperature is greater than or equal to 95°C.</li> <li>• A red indicator displays when the temperature is greater than or equal to 100°C.</li> </ul> <p><b>★ If the temperature is greater than 100°C, the user must manually shut off the card.</b></p>
AXI Bridge	#	The Advanced extensible interface bridge is running correctly on the card. This information is used by Ross Technical Support for diagnostics.
Fan Speed	#	Reports the speed (rpm) of the fan on the board
CPU Usage	x.xx / y.yy / z.zz	<p>Displays the CPU Load average where:</p> <ul style="list-style-type: none"> <li>• x.xx represents in the last minute</li> <li>• y.yy represents the last five minutes</li> <li>• z.zz represents the last fifteen minutes</li> </ul>
Uptime (System/App)	D HH:MM:SS	Reports the amount of time since the last reboot, or loss of connectivity, of the card
RAM Available	# / #.## MB	CPU Memory Used / Total CPU Memory
SD Card Status	x of #GB used	Reports the amount of memory used on the Micro SD card
<b>Daughter Card</b>		
Voltage (mV)	#	Measured input voltage

**Table 23 Hardware Tab**

Item	Parameters	Description
Current (mA)	#	Current consumption in milliamperes
Power (W)	#	Power consumption in watts

## Licensing State Tab

**Table 24** summarizes the information displayed in the Licensing State tab.

**Table 24 Licensing State Tab**

Item	Parameters	Description
Base Product Type	MC1-UHD	
<b>MC1-UHD-#-LICENSE</b>		
License State	Unlicensed	The license key for the feature is not installed. Navigate to the Configure License tab to enable this feature
	Licensed	The license key for this feature was correctly enabled in the Configure License tab

## Setup Tab

**Table 25** summarizes the options in the Setup tab.

**Table 25 Setup Tab**

Item	Parameters	Description
Reference Source	Frame 1	Assigns the source connected to the <b>REF 1</b> port on the openGear frame
	Frame 2	Assigns the source connected to the <b>REF 2</b> port on the openGear frame
	Local	Assigns the external reference source connected to <b>REF IN</b> port on the rear module
	Input SDI 1	Assigns the signal connected to the <b>SDI IN 1</b> port on the rear module
<b>Factory Defaults</b>		
Load Factory Defaults	All editable parameters in DashBoard, except those in the Network tab and any installed licenses, are reset to the factory default values. A reboot of the card may be required to update the parameters.	
<b>Card Lock</b>		
Unlocked*	All editable parameters in DashBoard can be modified by a user	
Locked	The DashBoard interface is locked. The editable parameters in DashBoard can no longer be modified by the user. To unlock the interface, select the box again.	
<b>Generate and Download MIBs File</b>		

**Table 25 Setup Tab**

Item	Parameters	Description
Download MIBs		Downloads the Management Information Base (MIB) file that provides the SNMP controls for your card

## Network Tab

**Table 26** summarizes the menus and read-only fields displayed in the Network tab.

**Table 26 Network Tab**

Item	Parameters	Description
<b>Network Time</b>		
Use time from Frame Network Controller	Selected	Enables the MC1-UHD to use the time data reported by the MFC-OG3-N or MFC-OGX-N that is installed in the same openGear frame
	Cleared	
<b>Default Gateway</b>		
Current (read-only)	###.###	Indicates the gateway for communications outside of the local area network (LAN)
Static Gateway	###.###	The Gateway for the MC1-UHD that the user manually assigned
<b>openGear Chassis RJ-45</b>		
Link Status (read-only)	OK (Green)	The MC1-UHD is communicating on the network via the MFC-OG3-N or MFC-OGX-N
	Invalid Subnet Mask (Yellow)	The Current Subnet Mask value is set incorrectly or is invalid within your network
	Apply/Cancel Changes (Yellow)	One or more setting on this tab was changed but the <b>Apply</b> button was not selected
	Not Present (Red)	A link could not be established using the present network setting values
	Link Down (Red)	The link for the MFC-OG3-N or MFC-OGX-N is invalid
Current IP Address (read-only)	###.###	Indicates the IP Address currently assigned to the MC1-UHD via the MFC-OG3-N or MFC-OGX-N
Current Subnet Mask (read-only)	###.###	Indicates the subnet mask for the MC1-UHD
MAC Address (read-only)	#	Indicates the MAC Address currently assigned to the MC1-UHD
Mode	Static	The user manually supplies the network settings for the MC1-UHD
	DHCP*	Automates the assignment of network settings for the MC1-UHD
Static IP Address	#	The IP Address for the MC1-UHD that the user manually assigned

**Table 26 Network Tab**

Item	Parameters	Description
Subnet Mask	#	The Subnet Mask for the MC1-UHD that the user manually assigned

## Global Alarm Enables Tab

**Table 27** summarizes the options displayed in the Global Alarm Enables tab.

**Table 27 Global Alarm Enables Tab**

Item	Parameters	Description
<b>Network Time</b>		
Network time (read-only)	#	Displays the time data transmitted by the Frame Controller card in the same openGear frame. Requires that the Global > Network > Use time from Frame Controller box is selected.
Alarm Enable	Selected	The MC1-UHD reports the NTP time as provided by the Frame Controller card
	Cleared*	Disables this alarm
<b>Rear Module Alarm</b>		
Rear Module (read-only)	This field replicates the information displayed in the Product > Rear Module Status field	
Alarm Enable	Selected*	The Global > Product > Rear Module Status field reports when a rear module is not compatible with the card
	Cleared	Disables this alarm
<b>Fan Alarm</b>		
Fan Speed (read-only)	#	Reports the fan speed (rpm) of the fan on the board
Alarm Enable	Selected*	The MC1-UHD reports when the fan is not working correctly
	Cleared	Disables this alarm
<b>Analog Reference Alarm</b>		
Reference Format (read-only)	OK (Green)	Indicates the detected reference format is supported
	Alarm Suppressed (Green)	The Alarm Enable box is cleared. The status of the reference signal will not be reported.
	Unlocked (Red)	A reference signal is detected, but the card is not locked to it
	Unsupported (Red)	A reference signal is detected, but the format is not supported by the MC1-UHD
	Incompatible (Red)	A reference signal is detected but the format is incompatible with the current output mode of the card



**Table 27 Global Alarm Enables Tab**

Item	Parameters	Description
Alarm Enable	Selected*	The Global > Signal > Analog Reference Status field reports when there is a loss of reference signal
	Cleared	Disables this alarm
<b>SDI Input Alarms</b>		
Input # Status (read-only)	Each field duplicates the information reported in the Configuration > Video Format > Input Status fields	
Alarm Enable	Selected*	MC1-UHD reports a loss of the specified input or if the format is incompatible for the specified input
	Cleared	Disables this alarm

## Security Tab

**Table 28** summarizes the options displayed in the Security tab.

**Table 28 Security Tab**

Item	Parameters	Description
<b>Security Configuration</b>		
SSH Login	Disable*	Disables the ability to log onto the MC1-UHD via an SSH server
	Enable	The MC1-UHD can be accessed via a secure channel by an SSH server

## Configure Licenses Tab

**Table 29** summarizes the read-only information displayed in the Configure Licenses tab.

**Table 29 Configure Licenses Tab**

Item	Parameters	Description
Base Product Type	MC1-UHD	
Feature	<license name>	Specifies the license(s) available for your card
Request Code	#	This character string is used to obtain a license key
Key	#	Specifies the license key that was provided to enable the licensed feature
	Licensed	The license key is valid and the licensed feature is enabled

## Logging Tab

**Table 30** summarizes the read-only information displayed in the Logging tab.

**Table 30 Logging Tab**

Item	Parameters	Description
Logging Level	Filters the events the System Log captures	
Remote Logging	###.##	Specifies the IP Address for the external device that is logging the communication activity for the MC1-UHD
System Log	Displays the events logged for the MC1-UHD since the last time the log was cleared	

## Configuration Interface

The Configuration interface is displayed by double-clicking the Configuration sub-node in the MC1-UHD tree.

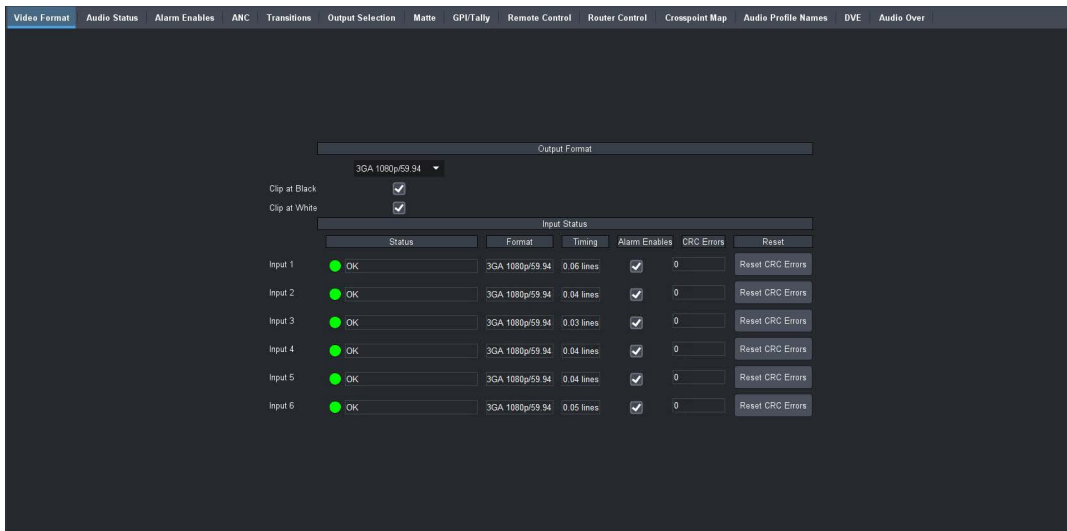

*Figure 24 Example of the Configuration Interface in Dashboard*

## Video Format Tab

**Table 31** summarizes the read-only information displayed in the Video Format tab.

**Table 31 Video Format Tab**

Item	Parameters	Description
<b>Output Format</b>		
Output Format	#	Selects the video format for the output signal. Note that a change in video format takes effect immediately. The default is 1080p/59.94.
Clip at Black	Selected*	Enables the card to clip to SMPTE black on all outputs
	Cleared	Super-black is not clipped (allows super-black)

**Table 31 Video Format Tab**

Item	Parameters	Description
Clip at White	Selected*	Enables the card to slip to SMPTE white on all outputs
	Cleared	Super-white is not clipped (allows super-white)
<b>Input Status - Input #</b>		
Status (read-only)	OK (Green)	The input signal is valid and no errors are detected
	Incompatible Video (Yellow)	The input video format is not supported by the reference format
	Invalid Video (Red)	The input signal is detected but it is in an unsupported format or an error is occurring
	No signal (Red)	No signal present on the specified input
Format (read-only)	#	Indicates the detected video format of the specified input signal
Timing (read-only)	# lines (to analog ref)	Indicates the timing of the specified input signal relative to the reference signal
Alarm Enables	Selected*	The MC1-UHD monitors the signal on the specified IN BNC and reports when an error is detected on the input signal
	Cleared	The MC1-UHD does not report when an error is detected on the specified input signal
CRC Errors	#	Displays the count of the CRC errors on the video input. This counter is reset on loss of video, or by user request. The counter is non-latching, and the count can roll over the counter.
	Reset	Resets the CRC Errors field

## Audio Status

**Table 32** summarizes the read-only information displayed in the Audio Status tab for each channel.

**Table 32 Audio Status Tab**

Item	Parameters	Description
<b>Embedded Audio # - Group #</b>		
Ch # Status (read-only)	PCM	The channel is PCM audio
	Non-PCM	The channel is non-PCM audio
	Absent	The audio channel is not detected or invalid

## Alarm Enables Tab

**Table 33** summarizes the options displayed in the Alarm Enables tab.

**Table 33 Alarm Enables Tab**

Item	Parameters	Description
<b>SDI Input #</b>		
Video	Selected*	An alarm is triggered when a missing or an invalid video signal is detected on the SDI input
	Cleared	The alarm is suppressed when a missing or an invalid video signal is detected on the SDI input
<b>SDI Input # - Audio Group #</b>		
Absent	Selected*	An alarm is triggered when a missing audio signal is detected on the SDI input
	Cleared	The alarm is suppressed when a missing audio signal is detected on the SDI input
Async	Selected*	An alarm is triggered when the audio signal is mistimed with the video on the SDI input
	Cleared	The alarm is suppressed when the audio signal is mistimed with the video on the SDI input

## ANC Tab

The ANC menus, status fields, and options are organized into three sub-tabs: ANC, Decode, and Encode. This section summarizes the options available in each sub-tab Dashboard.

### ANC

**Table 34** summarizes the options available in the **ANC** sub-tab Dashboard.

**Table 34 ANC — ANC Tab**

Item	Parameters	Description
ANC Frame Delay (read-only)	#	The frame delay is always relative to the next output frame. The output is at a fixed rate as defined by the Output Video mode.
<b>Packet Name (read-only)</b>		
Action	Delete	Card deletes the packet from the output
	Pass*	The card receives and re-inserts the specified packet type into the specified line without modifying the packet contents

**Table 34 ANC — ANC Tab**

Item	Parameters	Description
Insertion Line	Switch Line + #	Selects a line to insert the specified ANC packet on. Note that if more than one packet is to be inserted in the same line, the packet with the lowest insertion order number will be inserted first. The default is Switch Line + 2.
	Follow upstream	Inserts the packet on the same line as the upstream device
Insertion Order	#	Defines the hierarchy of the packets insertion Note that the lower the number, the higher priority the packet is given.
Line 21 Caption Pass-through <sup>a</sup>	Selected	Specifies to pass closed-captioning data on Line 21 unaltered. This setting should only be used when closed-captioning, or other data, is present on Line 21.
	Cleared	Disables this feature

a. This option only displays when the Configuration > Video Format > Output Format is set to 480i 59.94Hz.

## Decode

**Table 35** summarizes the **Decode** sub-tab fields available in DashBoard for each type of ANC data for each SDI signal.

**Table 35 ANC — Decode > SDI # Tab**

Item	Parameters	Description
Status (read-only)	OK	Expected decoded ANC data is present
	Exceeded Bandwidth	Captured VANC services exceeded bandwidth
	Missing	Expected decoded ANC data is not present
	Present in Luma and Chroma	Decoded data was found on both LUMA and CHROMA channels
	Unexpected: Field #	Receiving ANC data from wrong field
	Unexpected: LUMA	Receiving ANC data from wrong channel
	Unexpected: CHROMA	Receiving ANC data from wrong channel
	Line Out of Range	Receiving data from wrong line
	Too Many Packets in Frame	There is a data overflow
	Overflow	Exceeded decoded bandwidth. Lost data.
	CRC Error	CRC error found in decoded ANC data: some protocols only
	Parse Error	Decoded data does not match expected protocol
	Invalid Length	The length of decoded ANC packet is incorrect for service
Data Rate (Bytes/Sec) (read-only)	#	Reports the decoding data transfer rate; the number of bytes received in the last field
Line	#, <text>	Reports the data insertion location where # represents the specific line and <text> : <ul style="list-style-type: none"> <li>• HC represents HVANC CHROMA</li> <li>• HL represents HVANC LUMA</li> <li>• VC represents VANC CHROMA</li> <li>• VL represents VANC LUMA</li> </ul>
Alarm Enable	Selected	The MC1-UHD monitors the decoded ANC status and updates the Status field accordingly
	Cleared*	Disables this alarm
<b>Field #</b>		
Bandwidth Used (Percent) (read-only)	#	The overall bandwidth percentile including buffer overflow state, of all decoding ANC services

Encode

**Table 35** summarizes the **Encode** sub-tab fields available in DashBoard for the ANC data for each SDI signal.

**Table 36 ANC — Encode SDI # Tab**

Item	Parameters	Description
Status (read-only)	OK	Expected encoded ANC data is present
	Exceeded Bandwidth	Captured VANC services exceeded bandwidth
	Missing	Expected encoded ANC data is not present
	Present in Luma and Chroma	Encoded data was found on both LUMA and CHROMA channels
	Unexpected: Field #	Receiving ANC data from wrong field
	Unexpected: LUMA	Receiving ANC data from wrong channel
	Unexpected: CHROMA	Receiving ANC data from wrong channel
	Line Out of Range	Receiving data from wrong line
	Too Many Packets in Frame	There is a data overflow
	Overflow	Exceeded encoded bandwidth. Lost data.
	CRC Error	CRC error found in encoded ANC data: some protocols only
	Parse Error	Encoded data does not match expected protocol
	Invalid Length	The length of encoded ANC packet is incorrect for service
Data Rate (Bytes/Sec) (read-only)	#	Reports the encoding data transfer rate; the number of bytes received in the last field
Alarm Enable	Selected	The MC1-UHD monitors the encoded ANC status and updates the Status field accordingly
	Cleared*	Disables this alarm
<b>Field #</b>		
Bandwidth Used (Percent)	#	The overall bandwidth percentile including buffer overflow state, of all decoding ANC services

## Transitions Tab

**Table 37** summarizes the options displayed in the Transitions tab.

**Table 37 Transitions Tab**

Item	Parameters	Description
<b>Post Transition Behavior</b>		
Leave Preset As Is		The Preset bus remains unchanged after a transition
Swap Program/Preset*		The Program and Preset buses flip-flop after a transition
Preset Off		The Preset bus is unavailable after a transition

**Table 37 Transitions Tab**

Item	Parameters	Description
<b>Take During Transition Action</b>		
Ignore*		Select this option to disregard any successive presses of the TAKE button until the transition is complete
Pause		Select this option to pause the transition when the TAKE button is toggled, and resume the transition when the button is pressed again
Reverse		Select this option to reverse the transition back to the start
<b>Cut on Clean Feed</b>		
Selected		A cut is performed when transitioning to a clean feed output
Cleared*		Disables this feature
<b>Reset Audio Gain</b>		
Selected		Ramps the audio gain level to the default level as the Preview bus is transitioned after a TAKE
Cleared*		Keeps the audio gain level at the current level after a TAKE transition completes (the audio gain is not adjusted)
<b>GPI Triggered Keys to Override TAKE Transitions</b>		
GPI Overrides TAKE	Selected	Prevents GPI-triggered keys from being taken off-air by a TAKE transition. On activation, this feature disables the corresponding key on the preset bus.
	Cleared*	Disables this feature
<b>FTB Disabling</b>		
FTB Button	FTB Enabled	Selecting the FTB button performs a fade to black where the: program bus is faded to black at the FTB rate, the audio fades to silence, and closed captioning information is not passed
	FTB Disabled	The FTB button is grayed out on the interface, and selecting it has no effect

## Output Selection Tab

**Table 38** summarizes the options displayed in the Output Selections tab. .

**Table 38 Output Selection Tab**

Item	Parameters	Description
Output #	Black	Specified output displays black
	Program	Specified output displays the Program output
	Preview	Specified output displays the Preview output
	Clean #	Specified output displays the selected clean feed output
	Logo #	Assigns the specified logo channel to the output



## Matte Tab

**Table 39** summarizes the options displayed in the Matte tab for each matte generator.

**Table 39** *Matte Tab*

Item	Parameters	Description
<b>Matte #</b>		
Luma	#	Adjusts the luma component
Cr	#	Adjusts the blue-difference values of the matte generator channel where: <ul style="list-style-type: none"><li>• Increasing the value causes the display color to become increasingly saturated with blue</li><li>• Decreasing the value de-saturates the blue color from the display color</li></ul>
Cb	#	Adjusts the red-difference values of the matte generator channel where: <ul style="list-style-type: none"><li>• Increasing the value causes the display color to become increasingly saturated with red</li><li>• Decreasing the value de-saturates the red color from the display color</li></ul>

## GPI/Tally Tab

The GPI/Tally tab is divided into two sub-tabs: GPI/Tally and VGPI.

GPI/Tally Tab.

**Table 40** summarizes the options displayed in the GPI/Tally sub-tab.

**Table 40** *GPI/Tally > GPI/Tally Tab*

Item	Parameters	Description
<b>GPI/Tally #</b>		

**Table 40 GPI/Tally > GPI/Tally Tab**

Item	Parameters	Description
Function	None*	The specified GPIO port is not configured and the GPI has no effect. The Trigger/Tally Type setting is ignored.
	Tally Video Input #	Configures the GPIO port as an output and reflects the on-air status of the specified SDI IN signal
	Tally Key #	Configures the GPIO port as an output and reflects the on-air status of the specified Key
	Tally Any Key	Configures the GPIO port as an output; the Tally is active when any of the Keys are on-air
	Tally PGM XPT	Configures the GPIO port as an output and reflects the on-air status of the crosspoint specified in the Crosspoint Number field
	GPI Auto Key #	Configures the GPIO port as an output; the tally is active when an Audio Over channel is on-air
	GPI Cut Key	A cut transition is performed on the specified Key when a trigger is received by that GPI input
	GPI On Air	Configures the GPIO port as an input and reflects the on-air status of the source
	GPI Take	A Take transition is performed when a trigger is received by that GPI input
	GPI FTB	A fade to black is performed when a trigger is received that the specified GPI input
	GPI PGM XPT	Configures the GPIO port as an output and reflects the on-air status of the crosspoint specified in the Crosspoint Number field
	GPI Voice Over	Configures the GPIO port communicate with a device to receive an audio voice over when this GPI is triggered
	GPI EAS Audio Over	Configures the GPIO port to communicate with an EAS device to receive an EAS audio voice over when this GPI is triggered

**Table 40 GPI/Tally > GPI/Tally Tab**

Item	Parameters	Description
Trigger/Tally Type	Falling*	If configured for Falling Edge, the selected function is executed when the GPI input signal transitions from High to Low
	Rising	If configured for Rising Edge, the selected function is executed when the GPI input signal transitions from Low to High
	High	If configured for Active High, the selected function is executed when the GPI input signal is driven High
	Low	If configured for Active Low, the selected function is executed when the GPI input signal is driven Low
Current State (read-only)	High	Reports the tally status
	Low	
Output Pulse Width (frames)	#	Specifies the number of frames between the rising and falling edges of the output
Crosspoint Number	#	Only applicable when the <b>Function</b> is set to <b>Tally PGM XPT</b> or <b>GPI PGM XPT</b> . Specifies the crosspoint on the MC1-UHD that will trigger the tally. The crosspoint number can be either a router source or a button number, as determined by the <b>Remote Control &gt; Device Setup &gt; Switch Request</b> setting.
Manual Override	Selected	The user will trigger a switch in states
	Cleared	The port will trigger a switch in states
Level	High	The output toggles from the base low level to the high level. The output signal remains at this level until reset.
	Low	The output level toggles from the base high level to the low level. The output signal remains at this level until reset.
GPI/Tally Logging Level	Emergency	Events are listed in a hierarchical order based on the selected severity including: <ul style="list-style-type: none"> <li>• internal errors and unrecognized or invalid responses from the GPI/Tally port</li> <li>• failed communications between the MC1-UHD (such as time outs) and the device connected to the GPI/Tally port.</li> </ul> This is intended for troubleshooting incompatibilities between the MC1-UHD and downstream devices.
	Alert	
	Critical	
	Error	
	Warning	
	Notice	
Info*	The MC1-UHD provides a summary of commands sent to and responses via this GPI/Tally port	

## VGPI Tab

The **VGPI** tab provides configuration options for Virtual GPIs (VGPIs) when using the Miranda™ Presmaster or RossTalk protocols. **Table 41** provides a summary of the VGPI tab.

### For More Information on...

- the Presmaster protocol, refer to “**Using the Presmaster Protocol**”.
- the RossTalk protocol, refer to “**Using RossTalk**”.

**Table 41 GPI/Tally > VGPI Tab**

Item	Parameters	Description
<b>VGPI #</b>		
Function	SqueezeBack Effect 1 <sup>a</sup>	<ul style="list-style-type: none"> <li>• An ARM command (0x0130) will enable/disable SqueezeBack Preset 1 on the Preset bus</li> <li>• A STATE command (0x0140) will enable/disable SqueezeBack Preset 1 on the Program bus</li> </ul>
	SqueezeBack Effect 2 <sup>b</sup>	<ul style="list-style-type: none"> <li>• An ARM command (0x0130) will enable/disable SqueezeBack Preset 2 on the Preset bus</li> <li>• A STATE command (0x0140) will enable/disable SqueezeBack Preset 2 on the Program bus</li> </ul>
Function	SqueezeBack Effect 3 <sup>c</sup>	<ul style="list-style-type: none"> <li>• An ARM command (0x0130) will enable/disable SqueezeBack Preset 3 on the Preset bus</li> <li>• A STATE command (0x0140) will enable/disable SqueezeBack Preset 3 on the Program bus</li> </ul>
	SqueezeBack Effect 4 <sup>d</sup>	<ul style="list-style-type: none"> <li>• An ARM command (0x0130) will enable/disable SqueezeBack Preset 4 on the Preset bus</li> <li>• A STATE command (0x0140) will enable/disable SqueezeBack Preset 4 on the Program bus</li> </ul>
	None*	The specified VGPI is disabled.
State (read-only)	Up	When no SqueezeBack Preset is on Program and this command is in the Up state, the command selects the effect type of VGPI and transitions the selected effect on Program
	Down	When a SqueezeBack Preset is on Program and this command is in the Down state, the VGPI which has the same effect as the current one will be handled and the current effect will be off air or on Preview

**Table 41 GPI/Tally > VGPI Tab**

Item	Parameters	Description
Armed State	Disarmed*	In this state, the command excludes the specified SqueezeBack Preset in the transition (the <b>SQUEEZE</b> button is unlit on the On Air Control interface). This command will be ignored when the specified SqueezeBack Preset is on Program.
	Armed Up	In this state, the command includes the specified SqueezeBack Preset in the transition (the <b>SQUEEZE</b> button is lit on the On Air Control interface). This command will be ignored when the specified SqueezeBack Preset is on Program.
	Armed Down	In this state, the command excludes the specified SqueezeBack Preset in the transition (the <b>SQUEEZE</b> button is unlit on the On Air Control interface). This command will be ignored when the specified SqueezeBack Preset is on Program.

- a. The default value for VGPI 0.
- b. The default value for VGPI 1.
- c. The default value for VGPI 2.
- d. The default value for VGPI 3.

## Remote Control Tab

This section summarizes the options displayed in the Remote Control tab.

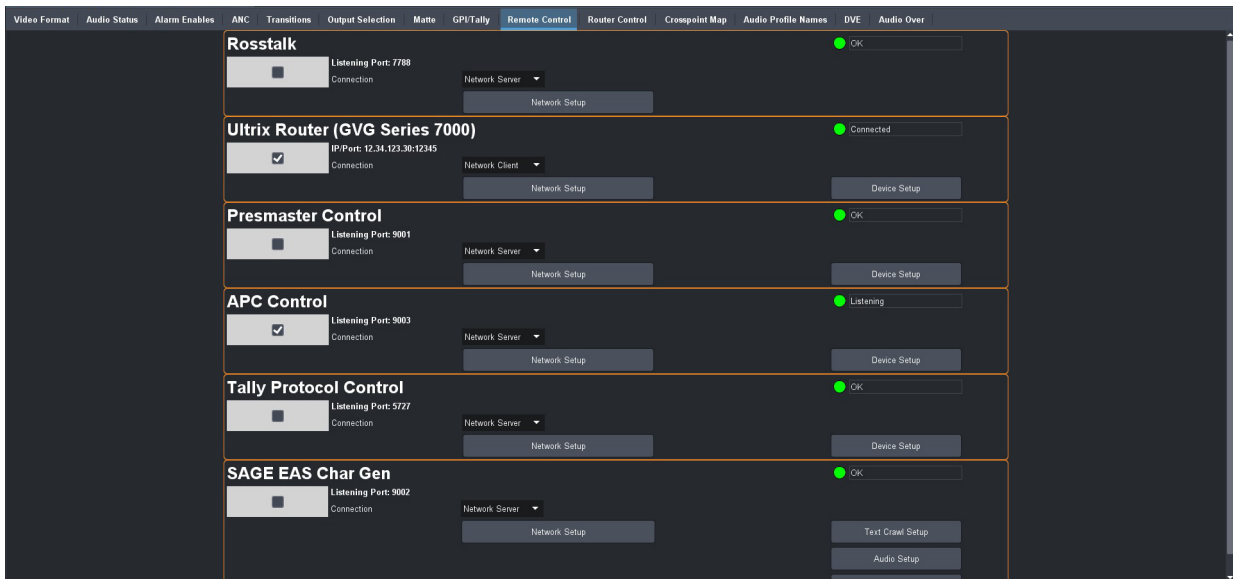

*Figure 25 Example of the Remote Control Tab*

## RossTalk

**Table 42** summarizes the RossTalk options displayed in the Remote Control tab.

**Table 42 Remote Control — RossTalk**

Item	Parameters	Description
Status (read-only)	Connected (Green)	<ul style="list-style-type: none"> <li>• <b>Enabled</b> box is selected for this protocol</li> <li>• <b>Connection</b> is set to <b>Network Client</b></li> <li>• Specified IP address and Port number are valid</li> <li>• MC1-UHD has successfully established connection to the given IP address and port</li> </ul>
	Inactive (Green)	<b>Enabled</b> box is not selected for RossTalk
	Listening (Green)	<ul style="list-style-type: none"> <li>• <b>Enabled</b> box is selected for RossTalk</li> <li>• <b>Connection</b> is set to <b>Network Server</b></li> <li>• Specified Port number is valid</li> <li>• MC1-UHD is ready to accept connections on the specified port</li> </ul>
	Reconnecting (Yellow)	<ul style="list-style-type: none"> <li>• <b>Enabled</b> box is selected for the protocol</li> <li>• <b>Connection</b> is set to <b>Network Client</b></li> <li>• MC1-UHD attempts to connect periodically to the specified IP address and Port number. The interval between connection attempts start at 10 seconds, increases by 10 seconds, to a maximum of 60 seconds.</li> </ul>
Status (read-only)	Connecting (Yellow)	<ul style="list-style-type: none"> <li>• <b>Enabled</b> box is selected for RossTalk</li> <li>• <b>Connection</b> is set to <b>Network Client</b></li> <li>• MC1-UHD is attempting to connect to the specified IP address and Port Number</li> </ul>
	Port in use (Red)	<ul style="list-style-type: none"> <li>• <b>Enabled</b> box is selected for RossTalk</li> <li>• <b>Connection</b> is set to <b>Network Server</b></li> <li>• Port Number specified in the Port field is invalid or in use by another service</li> </ul>
	Cannot connect (Red)	<ul style="list-style-type: none"> <li>• <b>Enabled</b> box is selected for RossTalk</li> <li>• <b>Connection</b> is set to <b>Network Client</b></li> <li>• Specified IP address and Port Number are invalid or in use by another device</li> </ul>
Enabled	Selected	Enables the protocol on the rear module Ethernet port
	Cleared*	Disables the protocol on the Ethernet port. When the check box is cleared, any incoming data from the external device is discarded by the MC1-UHD.

**Table 42 Remote Control — RossTalk**

Item	Parameters	Description
Connection	Network Server*	The MC1-UHD functions as a host, or socket listener, on the network
	Network Client	The MC1-UHD functions as a service requester that initiates communications with a server
Protocol	TCP*	Select this option if your external device is connected to the MC1-UHD through a network and uses the Transmission Control Protocol (TCP/IP)
	UDP	Select this option if your device is connected to the MC1-UHD through a network and uses the User Datagram Protocol (UDP/IP).
Port	#	When <b>Connection</b> is set to <b>Network Server</b> : <ul style="list-style-type: none"> <li>specifies the TCP or UDP port numbers where the MC1-UHD will listen on.</li> <li>TCP ports 0, 21, 80, 5253, and 6667 are unavailable for Ethernet communications</li> </ul>
		When <b>Connection</b> is set to <b>Network Client</b> , this menu specifies the remote port number to which the MC1-UHD will try to connect
IP Address	###.###	<ul style="list-style-type: none"> <li>Only applicable when <b>Connection</b> is set to <b>Network Client</b></li> <li>Specifies the IP address of the external device. The default is 0.0.0.0 and this must be changed to the actual IP address of the external device.</li> </ul>

Ultrix Router (GVG Series 7000)

**Table 43** summarizes the Ultrix Router (GVG Series 7000) options displayed in the Remote Control tab.

**Table 43 Remote Control — Utrix Router GVG Series 7000**

Item	Parameters	Description
Status (read-only)	Connected (Green)	<ul style="list-style-type: none"> <li>• <b>Enabled</b> box is selected for this protocol</li> <li>• <b>Connection</b> is set to <b>Network Client</b></li> <li>• Specified IP address and Port number are valid</li> <li>• MC1-UHD has successfully established connection to the given IP address and port</li> </ul>
	Inactive (Green)	<b>Enabled</b> box is not selected for GVG Series 7000
	Listening (Green)	<ul style="list-style-type: none"> <li>• <b>Enabled</b> box is selected for GVG Series 7000</li> <li>• <b>Connection</b> is set to <b>Network Server</b></li> <li>• Specified Port number is valid</li> <li>• MC1-UHD is ready to accept connections on the specified port</li> </ul>
	Reconnecting (Yellow)	<ul style="list-style-type: none"> <li>• <b>Enabled</b> box is selected for the protocol</li> <li>• <b>Connection</b> is set to <b>Network Client</b></li> <li>• MC1-UHD attempts to connect periodically to the specified IP address and Port number. The interval between connection attempts start at 10 seconds, increases by 10 seconds, to a maximum of 60 seconds.</li> </ul>
	Connecting (Yellow)	<ul style="list-style-type: none"> <li>• <b>Enabled</b> box is selected for GVG Series 7000</li> <li>• <b>Connection</b> is set to <b>Network Client</b></li> <li>• MC1-UHD is attempting to connect to the specified IP address and Port Number</li> </ul>
	Port in use (Red)	<ul style="list-style-type: none"> <li>• <b>Enabled</b> box is selected for GVG Series 7000</li> <li>• <b>Connection</b> is set to <b>Network Server</b></li> <li>• Port Number specified in the Port field is invalid or in use by another service</li> </ul>
Status (read-only)	Cannot connect (Red)	<ul style="list-style-type: none"> <li>• <b>Enabled</b> box is selected for GVG Series 7000</li> <li>• <b>Connection</b> is set to <b>Network Client</b></li> <li>• Specified IP address and Port Number are invalid or in use by another device</li> </ul>
Enabled	Selected	Enables the protocol on the rear module Ethernet port
	Cleared*	Disables the protocol on the Ethernet port. When the check box is cleared, any incoming data from the external device is discarded by the MC1-UHD.



**Table 43 Remote Control — Ultrix Router GVG Series 7000**

Item	Parameters	Description
Role	Server	The MC1-UHD functions as a host, or socket listener, on the network
	Client	The MC1-UHD functions as a service requester that initiates communications with a server
Protocol	TCP*	Select this option if your external device is connected to the MC1-UHD through a network and uses the Transmission Control Protocol (TCP/IP)
	UDP	Select this option if your device is connected to the MC1-UHD through a network and uses the User Datagram Protocol (UDP/IP).
Port	#	When <b>Connection</b> is set to <b>Network Server</b> : <ul style="list-style-type: none"> <li>specifies the TCP or UDP port numbers where the MC1-UHD will listen on.</li> <li>TCP ports 0, 21, 80, 5253, and 6667 are unavailable for Ethernet communications</li> </ul>
		When <b>Connection</b> is set to <b>Network Client</b> , this menu specifies the remote port number to which the MC1-UHD will try to connect
IP Address	###.###	<ul style="list-style-type: none"> <li>Only applicable when <b>Connection</b> is set to <b>Network Client</b></li> <li>Specifies the IP address of the external device. The default is 0.0.0.0 and this must be changed to the actual IP address of the external device.</li> </ul>
<b>Device Setup</b>		
Level Index	#	Specifies the level that the router will perform crosspoint switches on. The default is 1.
Take All Levels	Selected*	Specifies that all transitions take effect on all router levels
	Cleared	Disables this feature. Only the level specified in the Level Index field will be affected during a transition.
Send Optional Tabs	Selected	Includes the optional tab character between the last command parameter and the checksum. Refer to the documentation for your external device to determine if this character is required.
	Cleared*	Disables this feature

**Table 43 Remote Control — Ultrix Router GVG Series 7000**

Item	Parameters	Description
Log in Hexadecimal	Selected	The SEND and RECV log messages are displayed in hexadecimal (enabled via the Enable Log Messages area)
	Cleared*	Disables this feature
Disable Queries	Selected	The MC1-UHD does not send query commands to the external device. Select this option when connecting to a Grass Valley NV9000
	Cleared*	Disables this feature
Log Level	INFO	The MC1-UHD provides a summary of commands sent to and responses from the router
	SEND	The MC1-UHD provides a detailed report of commands sent to the router. By default, the box is unselected (cleared).
	RECV	The MC1-UHD provides a detailed report of router responses. By default, the box is unselected (cleared).
	WARN	Indicates failed communications between the MC1-UHD and the router (such as command time outs and checksum errors). By default, the box is selected.
	ERR	Reports internal errors and unrecognized or invalid responses from the router. This is intended for troubleshooting incompatibilities between the MC1-UHD and a third-party router. By default, the box is selected.

Presmaster Control

**Table 42** summarizes the Presmaster options displayed in the Remote Control tab.

**Table 44 Remote Control — Presmaster**

Item	Parameters	Description
Status (read-only)	OK (Green)	<ul style="list-style-type: none"> <li>• <b>Enabled</b> box is selected for this protocol</li> <li>• <b>Connection</b> is set to <b>Network Client</b></li> <li>• Specified IP address and Port number are valid</li> <li>• MC1-UHD has successfully established connection to the given IP address and port</li> </ul>
	Inactive (Green)	<p><b>Enabled</b> box is not selected for Presmaster</p>
	Listening (Green)	<ul style="list-style-type: none"> <li>• <b>Enabled</b> box is selected for Presmaster</li> <li>• <b>Connection</b> is set to <b>Network Server</b></li> <li>• Specified Port number is valid</li> <li>• MC1-UHD is ready to accept connections on the specified port</li> </ul>
	Reconnecting (Yellow)	<ul style="list-style-type: none"> <li>• <b>Enabled</b> box is selected for the protocol</li> <li>• <b>Connection</b> is set to <b>Network Client</b></li> <li>• MC1-UHD attempts to connect periodically to the specified IP address and Port number. The interval between connection attempts start at 10 seconds, increases by 10 seconds, to a maximum of 60 seconds.</li> </ul>
Status (read-only)	Connecting (Yellow)	<ul style="list-style-type: none"> <li>• <b>Enabled</b> box is selected for Presmaster</li> <li>• <b>Connection</b> is set to <b>Network Client</b></li> <li>• MC1-UHD is attempting to connect to the specified IP address and Port Number</li> </ul>
	Port in use (Red)	<ul style="list-style-type: none"> <li>• <b>Enabled</b> box is selected for Presmaster</li> <li>• <b>Connection</b> is set to <b>Network Server</b></li> <li>• Port Number specified in the Port field is invalid or in use by another service</li> </ul>
	Cannot connect (Red)	<ul style="list-style-type: none"> <li>• <b>Enabled</b> box is selected for Presmaster</li> <li>• <b>Connection</b> is set to <b>Network Client</b></li> <li>• Specified IP address and Port Number are invalid or in use by another device</li> </ul>
Enabled	Selected	<p>Enables the protocol on the rear module Ethernet port</p>
	Cleared*	<p>Disables the protocol on the Ethernet port. When the check box is cleared, any incoming data from the external device is discarded by the MC1-UHD.</p>

**Table 44 Remote Control — Presmaster**

Item	Parameters	Description
Connection	Serial Port	Enables the MC1-UHD to communicate with a third-party device via the Presmaster serial protocol
	Network Server	The MC1-UHD functions as a host, or socket listener, on the network
	Network Client	The MC1-UHD functions as a service requester that initiates communications with a server
<b>Network Setup</b>		
Packet Type	TCP*	Select this option if your external device is connected to the MC1-UHD through a network and uses the Transmission Control Protocol (TCP/IP)
	UDP	Select this option if your device is connected to the MC1-UHD through a network and uses the User Datagram Protocol (UDP/IP).
Port	#	When <b>Connection</b> is set to <b>Network Server</b> : <ul style="list-style-type: none"> <li>• specifies the TCP or UDP port numbers where the MC1-UHD will listen on.</li> <li>• TCP ports 0, 21, 80, 5253, and 6667 are unavailable for Ethernet communications</li> </ul>
		When <b>Connection</b> is set to <b>Network Client</b> , this menu specifies the remote port number to which the MC1-UHD will try to connect
Remote IP Address	###.###	<ul style="list-style-type: none"> <li>• Only applicable when <b>Connection</b> is set to <b>Network Client</b></li> <li>• Specifies the IP address of the external device. The default is 0.0.0.0 and this must be changed to the actual IP address of the external device.</li> </ul>
<b>Device Setup</b>		
Switch Request	Router Crosspoint*	The received value refers to a physical or virtual router crosspoint.
	Button Number	The received value refers to a specific MC1-UHD crosspoint button on the DashBoard control panel.
Log Level	Specifies the type of Presmaster events the MC1-UHD log will capture	
Automation Status Tally Enable	Selected	Enables the periodic sending of the automation status tally (0842) every # seconds (set by the Rate field). This tally reports the state of the ATMN button to the automation systems
	Cleared*	Disables this feature

**Table 44 Remote Control — Presmaster**

Item	Parameters	Description
Rate (s)	#	Specifies the frequency (in number of seconds) the MC1-UHD will send the automation status tally number command. The default is 10.

APC Control

**Table 42** summarizes the APC options displayed in the Remote Control tab.

**Table 45 Remote Control — APC**

Item	Parameters	Description
Status (read-only)	OK (Green)	<ul style="list-style-type: none"> <li>• <b>Enabled</b> box is selected for this protocol</li> <li>• <b>Connection</b> is set to <b>Network Client</b></li> <li>• Specified IP address and Port number are valid</li> <li>• MC1-UHD has successfully established connection to the given IP address and port</li> </ul>
	Inactive (Green)	<b>Enabled</b> box is not selected for APC
	Listening (Green)	<ul style="list-style-type: none"> <li>• <b>Enabled</b> box is selected for APC</li> <li>• <b>Connection</b> is set to <b>Network Server</b></li> <li>• Specified Port number is valid</li> <li>• MC1-UHD is ready to accept connections on the specified port</li> </ul>
Status (read-only)	Reconnecting (Yellow)	<ul style="list-style-type: none"> <li>• <b>Enabled</b> box is selected for the protocol</li> <li>• <b>Connection</b> is set to <b>Network Client</b></li> <li>• MC1-UHD attempts to connect periodically to the specified IP address and Port number. The interval between connection attempts start at 10 seconds, increases by 10 seconds, to a maximum of 60 seconds.</li> </ul>
	Connecting (Yellow)	<ul style="list-style-type: none"> <li>• <b>Enabled</b> box is selected for APC</li> <li>• <b>Connection</b> is set to <b>Network Client</b></li> <li>• MC1-UHD is attempting to connect to the specified IP address and Port Number</li> </ul>
	Port in use (Red)	<ul style="list-style-type: none"> <li>• <b>Enabled</b> box is selected for APC</li> <li>• <b>Connection</b> is set to <b>Network Server</b></li> <li>• Port Number specified in the Port field is invalid or in use by another service</li> </ul>
	Cannot connect (Red)	<ul style="list-style-type: none"> <li>• <b>Enabled</b> box is selected for APC</li> <li>• <b>Connection</b> is set to <b>Network Client</b></li> <li>• Specified IP address and Port Number are invalid or in use by another device</li> </ul>

**Table 45 Remote Control — APC**

Item	Parameters	Description
Enabled	Selected	Enables the protocol on the rear module Ethernet port
	Cleared*	Disables the protocol on the Ethernet port. When the check box is cleared, any incoming data from the external device is discarded by the MC1-UHD.
Connection	Serial Port	Enables the MC1-UHD to communicate with a third-party device via the APC serial protocol
	Network Server	The MC1-UHD functions as a host, or socket listener, on the network
	Network Client	The MC1-UHD functions as a service requester that initiates communications with a server
Protocol	TCP*	Select this option if your external device is connected to the MC1-UHD through a network and uses the Transmission Control Protocol (TCP/IP)
	UDP	Select this option if your device is connected to the MC1-UHD through a network and uses the User Datagram Protocol (UDP/IP).
Port	#	<p>When <b>Connection</b> is set to <b>Network Server</b>:</p> <ul style="list-style-type: none"> <li>specifies the TCP or UDP port numbers where the MC1-UHD will listen on.</li> <li>TCP ports 0, 21, 80, 5253, and 6667 are unavailable for Ethernet communications</li> </ul>
		<p>When <b>Connection</b> is set to <b>Network Client</b>, this menu specifies the remote port number to which the MC1-UHD will try to connect</p>
IP Address	###.###	<ul style="list-style-type: none"> <li>Only applicable when <b>Connection</b> is set to <b>Network Client</b></li> <li>Specifies the IP address of the external device. The default is 0.0.0.0 and this must be changed to the actual IP address of the external device.</li> </ul>
<b>Device Setup</b>		
Switch Request	Router Crosspoint*	The received value refers to a physical or virtual router crosspoint.
	Button Number	The received value refers to a specific MC1-UHD crosspoint button on the DashBoard control panel.
Log Level	Specifies the type of events the MC1-UHD log will capture	

## Tally Protocol Control

**Table 42** summarizes the Tally Protocol options displayed in the Remote Control tab.

**Table 46 Remote Control — Tally Protocol**

Item	Parameters	Description
Status (read-only)	OK (Green)	<ul style="list-style-type: none"> <li>• <b>Enabled</b> box is selected for a TSL protocol</li> <li>• <b>Connection</b> is set to <b>Network Client</b></li> <li>• Specified IP address and Port number are valid</li> <li>• MC1-UHD has successfully established connection to the given IP address and port</li> </ul>
	Inactive (Green)	<b>Enabled</b> box is not selected for a TSL protocol
	Listening (Green)	<ul style="list-style-type: none"> <li>• <b>Enabled</b> box is selected for a TSL protocol</li> <li>• <b>Connection</b> is set to <b>Network Server</b></li> <li>• Specified Port number is valid</li> <li>• MC1-UHD is ready to accept connections on the specified port</li> </ul>
	Reconnecting (Yellow)	<ul style="list-style-type: none"> <li>• <b>Enabled</b> box is selected for a TSL protocol</li> <li>• <b>Connection</b> is set to <b>Network Client</b></li> <li>• MC1-UHD attempts to connect periodically to the specified IP address and Port number. The interval between connection attempts start at 10 seconds, increases by 10 seconds, to a maximum of 60 seconds.</li> </ul>
	Connecting (Yellow)	<ul style="list-style-type: none"> <li>• <b>Enabled</b> box is selected for a TSL protocol</li> <li>• <b>Connection</b> is set to <b>Network Client</b></li> <li>• MC1-UHD is attempting to connect to the specified IP address and Port Number</li> </ul>
	Port in use (Red)	<ul style="list-style-type: none"> <li>• <b>Enabled</b> box is selected for a TSL protocol</li> <li>• <b>Connection</b> is set to <b>Network Server</b></li> <li>• Port Number specified in the Port field is invalid or in use by another service</li> </ul>
Status (read-only)	Cannot connect (Red)	<ul style="list-style-type: none"> <li>• <b>Enabled</b> box is selected for a TSL protocol</li> <li>• <b>Connection</b> is set to <b>Network Client</b></li> <li>• Specified IP address and Port Number are invalid or in use by another device</li> </ul>
Enabled	Selected	Enables communication via a TSL protocol on the rear module Ethernet port
	Cleared*	Disables the protocol on the Ethernet port. When the check box is cleared, any incoming data from the external device is discarded by the MC1-UHD.

**Table 46 Remote Control — Tally Protocol**

Item	Parameters	Description
Connection	Serial Port	Enables the MC1-UHD to communicate with a third-party device via a TSL protocol serial protocol
	Network Server	The MC1-UHD functions as a host, or socket listener, on the network
	Network Client	The MC1-UHD functions as a service requester that initiates communications with a server
<b>Network Setup</b>		
Packet Type	TCP*	Select this option if your external device is connected to the MC1-UHD through a network and uses the Transmission Control Protocol (TCP/IP)
	UDP	Select this option if your device is connected to the MC1-UHD through a network and uses the User Datagram Protocol (UDP/IP).
Port	#	When <b>Connection</b> is set to <b>Network Server</b> : <ul style="list-style-type: none"> <li>specifies the TCP or UDP port numbers where the MC1-UHD will listen on.</li> <li>TCP ports 0, 21, 80, 5253, and 6667 are unavailable for Ethernet communications</li> </ul>
		When <b>Connection</b> is set to <b>Network Client</b> , this menu specifies the remote port number to which the MC1-UHD will try to connect
Remote IP	###.###	<ul style="list-style-type: none"> <li>Only applicable when <b>Connection</b> is set to <b>Network Client</b></li> <li>Specifies the IP address of the external device. The default is 0.0.0.0 and this must be changed to the actual IP address of the external device.</li> </ul>
<b>Device Setup - TSL Control</b>		
Tally #	Unused	
	Program	
	Preview	

SAGE EAS Char Gen

**Table 42** summarizes the SAGE EAS protocol options displayed in the Remote Control tab.



**Table 47 Remote Control — SAGE EAS Protocol**

Item	Parameters	Description
Status (read-only)	OK (Green)	<ul style="list-style-type: none"> <li>• <b>Enabled</b> box is selected for the SAGE EAS Generic Character Generator protocol</li> <li>• <b>Connection</b> is set to <b>Network Client</b></li> <li>• Specified IP address and Port number are valid</li> <li>• MC1-UHD has successfully established connection to the given IP address and port</li> </ul>
	Inactive (Green)	<p><b>Enabled</b> box is not selected for the SAGE EAS protocol</p>
	Listening (Green)	<ul style="list-style-type: none"> <li>• <b>Enabled</b> box is selected for the SAGE EAS protocol</li> <li>• <b>Connection</b> is set to <b>Network Server</b></li> <li>• Specified Port number is valid</li> <li>• MC1-UHD is ready to accept connections on the specified port</li> </ul>
	Reconnecting (Yellow)	<ul style="list-style-type: none"> <li>• <b>Enabled</b> box is selected for the SAGE EAS protocol</li> <li>• <b>Connection</b> is set to <b>Network Client</b></li> <li>• MC1-UHD attempts to connect periodically to the specified IP address and Port number. The interval between connection attempts start at 10 seconds, increases by 10 seconds, to a maximum of 60 seconds.</li> </ul>
	Connecting (Yellow)	<ul style="list-style-type: none"> <li>• <b>Enabled</b> box is selected for the SAGE EAS protocol</li> <li>• <b>Connection</b> is set to <b>Network Client</b></li> <li>• MC1-UHD is attempting to connect to the specified IP address and Port Number</li> </ul>
	Port in use (Red)	<ul style="list-style-type: none"> <li>• <b>Enabled</b> box is selected for the SAGE EAS protocol</li> <li>• <b>Connection</b> is set to <b>Network Server</b></li> <li>• Port Number specified in the Port field is invalid or in use by another service</li> </ul>
Status (read-only)	Cannot connect (Red)	<ul style="list-style-type: none"> <li>• <b>Enabled</b> box is selected for the SAGE EAS protocol</li> <li>• <b>Connection</b> is set to <b>Network Client</b></li> <li>• Specified IP address and Port Number are invalid or in use by another device</li> </ul>

**Table 47 Remote Control — SAGE EAS Protocol**

Item	Parameters	Description
Enabled	Selected	Enables communication via the SAGE EAS protocol on the rear module Ethernet port
	Cleared*	Disables the protocol on the Ethernet port. When the check box is cleared, any incoming data from the external device is discarded by the MC1-UHD.
Connection	Serial Port	Enables the MC1-UHD to communicate with a third-party device via the SAGE EAS protocol serial protocol
	Network Server	The MC1-UHD functions as a host, or socket listener, on the network
	Network Client	The MC1-UHD functions as a service requester that initiates communications with a server
<b>Network Setup</b>		
Packet Type	TCP*	Select this option if your external device is connected to the MC1-UHD through a network and uses the Transmission Control Protocol (TCP/IP)
	UDP	Select this option if your device is connected to the MC1-UHD through a network and uses the User Datagram Protocol (UDP/IP).
Port	#	When <b>Connection</b> is set to <b>Network Server</b> : <ul style="list-style-type: none"> <li>• specifies the TCP or UDP port numbers where the MC1-UHD will listen on.</li> <li>• TCP ports 0, 21, 80, 5253, and 6667 are unavailable for Ethernet communications</li> </ul>
		When <b>Connection</b> is set to <b>Network Client</b> , this menu specifies the remote port number to which the MC1-UHD will try to connect
Remote IP	###.###	<ul style="list-style-type: none"> <li>• Only applicable when <b>Connection</b> is set to <b>Network Client</b></li> <li>• Specifies the IP address of the external device. The default is 0.0.0.0 and this must be changed to the actual IP address of the external device.</li> </ul>
<b>Text Crawl Setup - High, Medium, Low<sup>a</sup></b>		

**Table 47 Remote Control — SAGE EAS Protocol**

Item	Parameters	Description
Preview	Off*	Disables the setup mode; removes test message from the Preview output
	Low Priority	Displays the corresponding text crawl on the Preview output, permitting the user to configure the text crawl settings while in view.  Refer to the FCC's EAS regulations at 47 C.F.R. Part 11 for more information on message categories.
	Medium Priority	
	High Priority	
% From Top	0-100	Adjusts the vertical position of the EAS text overlay where 0 sets the top of the overlay at the top of the active video, 50 is centered horizontally, and 100 sets the bottom of the overlay on the bottom of the active video. The default is 10.
Text Size	1-10	Specifies the text size where 1 is smallest and 10 is largest. The actual text size depends on the video format. The default is 5.
Text Color		Specifies the foreground color of the text. The default is White.
Background Color		Specifies the background color behind the text. Each message category has a unique default value as follows: <ul style="list-style-type: none"> <li>• High Priority — Red</li> <li>• Medium Priority — Yellow</li> <li>• Low Priority — Green</li> </ul>
Drop Shadow	Selected	Applies a visual effect that makes the text appear three-dimensional. This is the default.
	Cleared	Disables this feature
Pan Speed	-5 to -1	Determines how fast the EAS message scrolls across the screen (from left to right) where: 5 is the fastest speed and 1 is the slowest
Play Count	1 to 10	Specifies the number of times to display the entire text crawl before taking it off air. The default is 2.
Duration (seconds)	#	Determines how long the EAS message scrolls on the screen before taking it off air
Until Plays Completed	Selected	Enables the EAS text crawl to continue to play until the number of plays equals the value specified in the <b>Play Count</b> menu
	Cleared	Disables this feature

**Table 47 Remote Control — SAGE EAS Protocol**

Item	Parameters	Description
Until Duration Completed	Selected	Enables the EAS text crawl to continue to play until the value in the <b>Duration</b> menu is reached
	Cleared	Disables this feature
While Voice Over Active	Selected	Enables the EAS text crawl to continue to play only while the EAS Voice Over source is playing
	Cleared	Disables this feature
<b>Audio Setup - Voice Over Audio Setup</b>		
Duck Level (dB)	#	Specifies the amount (dB) to reduce the audio level on the Program bus during an EAS alert
Gain (dB)	#	Adjusts the overall EAS audio gain on the Program bus while an EAS alert is active (applies to the input audio and the EAS input audio)
<b>Audio Over</b>		
Ch # Source		Specifies the audio source to include in the EAS output

- a. The Text Crawl Setup dialog enables you to customize the EAS text overlay received by your SAGE EAS device. The text overlay is automatically assigned to Logo channel 4 in Key 4, therefore do not use Logo 4 and Keyer 4 for any other purpose when EAS is enabled.

## Router Control Tab

**Table 48** summarizes the options displayed in the Router Control tab.

**Table 48 Router Control Tab**

Item	Parameters	Description
Status (read-only)		Reports the most serious router control error currently detected
<b>SDI #</b>		
Status (read-only)	OK (Green)	All router sources are available to the crosspoints
	Parked (Green)	The specified output is parked because a crosspoint was selected that was not a router source or the SDI Input is not used on-air
Destination	Unassigned	The MC1-UHD will not attempt any router switches
	Dest #	Specifies the router output source connected to the specified MC1-UHD input BNC

**Table 48 Router Control Tab**

Item	Parameters	Description
Park Source	Unknown	When an internal source, such as internal logo, black, SDI input or Key Video/Alpha is selected, the MC1-UHD routes this router source to the corresponding destination
	Src #	
Last Requested (read-only)	<text>	Indicates the last switch request sent for this destination
Last Known (read-only)	<text>	Displays what the router is reporting as the active Source on this destination
Selected On (read-only)	PGM	Indicates where the SDI input is used in the on-air
	PST	
	ExtKey#A or ExtKey#V	
	Unused	
Minimum Delay (frames)	#	Specifies the length of time, in frames, that the MC1-UHD will wait after sending a command to the router before it assumes the router output is switched. This could be extended up to the Retry Interval value before either the switch is re-tried or abandoned. The default is 3.
Retry Interval (frames)	#	<ul style="list-style-type: none"> <li>Specifies the number of frames the MC1-UHD will wait before re-sending a command to the router</li> <li>It is recommended that this value is at least 3 frames more than the Minimum Delay value</li> <li>The default is 6</li> </ul>
Max Retries	#	Specifies the maximum number of attempts the MC1-UHD will re-send a command to the router. Once the maximum is reached, the MC1-UHD abandons the switch (pushes back to the original crosspoint number). The default is 3.
Min Delay (read-only)	#	Reports the measured Minimum Delay time since the counters were reset
Max Delay (read-only)	#	Reports the measured Maximum Delay time since the counters were reset
Average Delay (read-only)	#	Reports the average delay based on the Min. Delay and the Max. Delay values
Total Switches (read-only)	#	Reports the total number of crosspoint switch commands the MC1-UHD has sent to the router
Total Retries (read-only)	#	Reports the total number of times the same crosspoint switch command was sent by the MC1-UHD to the router

**Table 48 Router Control Tab**

Item	Parameters	Description
Failed Retries (read-only)	#	Reports the total number of times the same crosspoint switch command failed to be sent by the MC1-UHD to the router
Counters	Reset	Clears the Min. Delay, Max. Delay, Average Delay, Total Switches, and Total Retries fields to zero (0)
Labels	Load	The MC1-UHD automatically retrieves the virtual labels from the router. The label is applied when the user selects the source in the crosspoint menu. Use this option if the router supports automatic label retrieval.
<b>Limit Label Lists - Sources, Destinations</b>		
Start Index	#	Specifies the first source label to report
End Index	#	Specifies the last source label to report
Number Received (read-only)	#	Indicates the total number of router labels reported to the MC1-UHD
Number Shown (read-only)	#	Indicates the total number of router labels displayed to the MC1-UHD

## Crosspoint Map Tab

**Table 49** summarizes the options displayed in the Crosspoint Map tab.

**Table 49 Crosspoint Map Tab**

Item	Parameters	Description
<b>Button #</b>		
Source Type	Matte	Specifies the function of the selected crosspoint. This determines the available options listed in the Selection menu.
	Black	
	SDI Input	
	Logo	
	Router	
Label	<text>	Assigns new text as the button label. This field is automatically populated by labels provided by the connected router for the Router crosspoints.
TSL Address	0 - 126	Specifies the identification enumeration
<b>Source Type &gt; Matte</b>		
Selection	White	Assigns white as the source for the crosspoint
	Matte#	Assigns the specified Matte generator as the source for the crosspoint
<b>Source Type &gt; SDI Input</b>		

**Table 49 Crosspoint Map Tab**

Item	Parameters	Description
Selection	SDI #	Assigns the specified SDI input as the source for the crosspoint. This list is populated with the router source labels if they are supported by the router.
Alpha	SDI #	Assigns the specified SDI input as the alpha channel for the crosspoint. This list is populated with the router source labels if they are supported by the router.
	None	Assigns White as the alpha channel for the crosspoint
<b>Source Type &gt; Router</b>		
Selection	Router Extra	Allows automation to request router sources that do not appear in the Crosspoint list
	Src #	Assigns the specified router source as the input for the crosspoint
Alpha	Src #	Assigns the specified router source as the alpha channel for the crosspoint
	None	Assigns White as the alpha channel for the crosspoint
<b>Source Type &gt; Logo</b>		
Selection	Logo #	Assigns the specified logo channel as the source for the crosspoint
Update Router Extra labels	Selected	When the Source Type is set to Router Extra, the button label on the On Air Control interface reports the last used router source. When automation requests a router source not listed in the crosspoints, and instead uses a Router Extra crosspoint, the label is updated to show the router source that was requested.
	Cleared	Disables this feature
Number of Buttons	#	Specifies the number of crosspoint buttons to display on each bus of the On Air Control interface
Number of Channel Select Buttons	#	Specifies the number of Channel Select buttons, to a maximum of 10, that display in the top row of the <b>On Air Control</b> interface
IP Address of Frame	##.##.##	Specifies the IP address of the router the card is communicating with

**Table 49 Crosspoint Map Tab**

Item	Parameters	Description
Default Label on Source Change	Selected	The crosspoint label automatically uses the name of the signal specified in the <b>Selection</b> menu. The label can still be edited manually but the label text will change if the <b>Selection</b> menu value changes.
	Cleared*	The crosspoint label is not auto-assigned based on the Selection menu

## Audio Profile Names Tab

**Table 50** summarizes the options displayed in the Audio Profile tab.

**Table 50 Audio Profile Tab**

Item	Parameters	Description
Save to Profile	<text>	Saves the current audio shuffle and processing settings to the selected profile
Set Profile Name	<text>	Enables you to assign a unique identifier to the selected audio profile

## DVE Tab

**Table 50** summarizes the options displayed in the DVE tab.

**Table 51 DVE Tab**

Item	Parameters	Description
Included in SqueezeBack	Background Only*	Only the background is included in the SqueezeBack effect
	After Key 1 <sup>a</sup>	Key 1 is included in the squeeze effect. Keys 2 to 4 are excluded.
	After Key 2	Keys 1 and 2 are included in the squeeze effect. Keys 3 to 4 are excluded.
	After Key 3	Keys 1 to 3 are included in the squeeze effect. Key 4 is excluded.
	After Key 4	All keys are included from the squeeze effect
Background in Fade	Background	Selects between letting the reveal source background pass through or fade to complete black during a V-fade type transition inside an already squeezed image on the PGM bus.
	Black	

a. Refer to **"SqueezeBack Effects"** for more information.



## Audio Over Tab

**Table 52** summarizes the options displayed in the Audio Over tab.

**Table 52 Audio Over Tab**

Item	Parameters	Description
<b>Audio Over</b>		
Sources - Ch#	None	No source is assigned to the specified voice over channel
	AES # Ch #	Embeds the specified channel in the specified voice over channel
<b>EAS Audio Sources</b>		
Sources - Ch#	None	No source is assigned to the specified EAS audio channel
	AES # Ch #	Embeds the specified channel in the specified EAS channel

## On Air Control Interfaces

The On Air Control interface enables you to setup and perform transitions. There are two distinct panels:

- Setup — This panel is the top half of the interface and includes the Home, Keyers, and Logo tabs.
- Control — This panel is the lower half of the On Air Control interface and includes the Program and Preset buses, Keyers area, Transition area, and TAKE button.



*Figure 26 Example of the On Air Control Interface*

## Home Tab

The Home tab is the first tab that displays in the Setup panel. **Table 53** summarizes the options displayed in the Home tab.

**Table 53 Home Tab**

Item	Parameters	Description
<b>Transition Rates (frames)</b>		

**Table 53 Home Tab**

Item	Parameters	Description
Slow Rate	2 to 999 <sup>a</sup>	Defines the Slow Rate in frames
Med Rate	2 to 999 <sup>b</sup>	Defines the Medium Rate in frames
Fast Rate	2 to 999 <sup>c</sup>	Defines the Fast Rate in frames
FTB Rate	2 to 999 <sup>d</sup>	Defines the Bade to Black Rate in frames
EAS STATUS	ON <text>	Indicates that an installed EAS is providing content to the MC1-UHD text overlay; the text is displayed in this area, and is color-coded, when the EAS is active
	OFF	Indicates that the MC1-UHD text overlay does not include EAS content

- a. The default value is 60 frames.
- b. The default value is 30 frames.
- c. The default value is 15 frames.
- d. The default value is 30 frames.

## Keyers Tabs

The Keyers tab is the second tab that displays in the Setup panel. Each keyer has a sub-tab that enables you to select video sources, key types, and adjust transparency, clip, and gain. The MC1-UHD supports Auto Select and Self keys. **Table 54** summarizes the options displayed in each Key sub-tab.

**Table 54 Keyers — Key # Tabs**

Item	Parameters	Description
Transparency	0* to 100	Adjusts the transparency level of the key: <ul style="list-style-type: none"><li>• 0 — The key is completely opaque; there is no difference between the original key and the key with the transparency effect applied to it.</li><li>• 100 — The key is completely transparent; the key is not visible on the screen.</li></ul>
Clip	#	Adjusts the clip values; default is 960 (the maximum luminance range not including Super White).
Gain	0 to 100	Adjusts the gain values; default is 50.

**Table 54 Keyers — Key # Tabs**

Item	Parameters	Description
Key Type	Auto Select*	A Key which uses two video signals (Alpha and Fill); the Key Alpha Type is automatically set to Shaped. If you configure an internal Logo channel as Auto Select, the associated alpha signal is used.
	Self	A Key that uses the luminance values of the KEY VIDEO source for the alpha; the Key Alpha Type is automatically set to Unshaped. If you configure an internal Logo channel as Self, the luminance value of the associated alpha is used.
Key Alpha Type	Unshaped*	The card performs a multiplicative key. The Key Alpha luminance value mixes linearly the Key Video with the Background. Shades of gray, in the Key Alpha, are translated into transparency levels, giving the key a soft edge.
	Shaped	The card performs an additive key. The Key Alpha cuts a hole in the BKGD and the Key Video is added to the BKGD. Shaped Key alphas are sometimes used with Character Generators to cut very precise holes for the Key Video fill.
Key Invert	On	Reverses the polarity of the Key Alpha. A Key Invert can be applied to any key type.
	Off*	The Key Alpha is not inverted
Default	Make Linear	Resets the clip and gain values to the default settings
<b>Keyer Source</b>		
Black	Assigns Black as the keyer output.	
Matte #	Assigns the specified Matte generator as the keyer output.	
External #	Assigns the external key source as the keyer output. You will also need to configure the settings in the <b>External Sources</b> tab	
Logo #	Assigns the specified Logo channel as the keyer output.	

## SqueezeBack Effects Tabs

**Table 55** summarizes the **SqueezeBack Effects** tab options available in DashBoard.

**Table 55 SqueezeBack Effects Tabs Options**

Item	Parameters	Description
<b>Effect #</b>		
Hide Effect	Selected	Enables the effect to be selected for a transition using the EFFECT SELECT button
	Cleared*	Disables the effect
X Position	# <sup>a</sup>	Adjusts the horizontal position of the image on the screen (in number of pixels)
Y Position	# <sup>a</sup>	Adjusts the vertical position of the image on the screen (number of lines)
X Size	0- # <sup>b</sup>	Squeezes the image horizontally (to the specified in number of pixels)
Y Size	0- # <sup>b</sup>	Squeezes the image vertically (to the specified in number of lines)
Lock Aspect Ratio	Selected*	Locks the aspect ratio given the current X and Y size parameters. Changing one parameter will cause the other parameter to automatically change to maintain this ratio.
	Cleared	X and Y parameters are adjusted independently
Constrain to Screen	Selected*	Applies “snap-back” on the X, Y position controls to ensure the squeezed image remains entirely on screen
	Cleared	The squeezed image can be clipped off screen
Reveal Source	External	Specifies that a router source will be the video source to be revealed by the squeeze effect. You must also specify the router source using the options in the External Sources tab.
	Logo # <sup>c</sup>	Specifies the logo channel as the video source to be revealed by the squeeze effect
	Matte #	Specifies the matte generator as the video source to be revealed by the squeeze effect
Reset to Defaults	Returns all parameters on the SqueezeBack Effects tab to the factory default values	

- a. The range is from -# to +#. The default value is 0% which positions the image at the center point of the visible area.
- b. The default is 100%.
- c. The default Reveal Source is as follows: Effect 1 defaults to External 1; Effect 2 to External 2; Effect 3 to Logo 1; Effect 4 to Logo 2.

## Logo Tabs

Each logo channel has a sub-tab that enables you to select files, position the on-screen image, and specify animation play-out settings. **Table 54** summarizes the options displayed in each Logo tab.E

**Table 56 Logo — Logo # Tabs**

Item	Parameters	Description
File (read-only)	xxx_##.yyy	Indicates the full path of the currently loaded file where ## represents the duration of the file if it is an animation
Status (read-only)	Loading frame X of Y	<ul style="list-style-type: none"> <li>Displays information about the channel in both the number of frames (integer), and in the number of seconds (fractional)</li> <li>Any errors during loading are also displayed</li> <li>When the file(s) have loaded, this field displays the dimensions of the image (e.g. 1920x1080)</li> </ul>
	Animation loaded (#)	
	Single image loaded (#)	
	Idle	
	Queued	Indicates that one logo channel is loading and a second channel was selected to load at the same time. Once the first channel is loaded, the second channel will begin loading.
Selected on (read-only)	#	Indicates all the key(s), or backgrounds, that currently have the media file selected
	None	
On Air (read-only)	#	Indicates the on-air key(s), or backgrounds, that have this media file selected
Directory	[RAM CACHE]	The field displays the directory the currently selected media file is located in
	[ROOT]	Lists the directories on the Micro SD Card
Filename	xxx.yyy xxx_####.yyy	<p>Displays the name of the selected media file.</p> <p>Animation filenames include an underscore followed by three or more digits. The number of frames, and duration in seconds, is displayed in brackets after the filename.</p> <p>Updated when a new Directory is selected in the <b>Directory</b> menu.</p> <p>Provides a list of all the media files in the currently selected directory. Note that animations appear as a single entry.</p>
	[NONE]	<p>Selecting this option clears the logo channel.</p> <p>This item is automatically selected, without clearing the channel, when the user switches to a new directory</p>
File List	Rescan	Selecting this button updates the Directory menu options, and the Filename menu options

**Table 56 Logo — Logo # Tabs**

Item	Parameters	Description
SD Card Status (read-only)	x of #GB used	Reports the amount of memory used on the Micro SD card
Mediastore Memory (read-only)	# / # / # MB	Reports the amount of memory used by the Mediastore
<b>Image Properties</b>		
X Position	## to ## <sup>a</sup>	<ul style="list-style-type: none"> <li>Adjusts the position of the image along the X-axis in number of pixels</li> <li>The range varies depending on the output video format</li> </ul>
Y Position	## to ## <sup>a</sup>	<ul style="list-style-type: none"> <li>Adjusts the position of the image along the Y-axis in number of pixels</li> <li>The range varies depending on the output video format</li> </ul>
<b>Animation Properties</b>		
Auto Play <sup>b</sup>	Selected	The animation starts to play when a transition occurs
	Cleared*	The animation starts playing as soon as the animation is loaded to the bus
Looping <sup>c</sup>	Selected	The animation starts over when it reaches the last frame of the animation
	Cleared*	The animation stops when it reaches the last frame of the animation
Play Mode <sup>d</sup>	Normal*	The entire frame of the image is displayed
	Swap Fields	Field 1 and Field 2 of the image are swapped when they are displayed.
Hold Time <sup>e</sup>	#	The animation plays but before looping back (if looping is enabled), it pauses on the last frame, for the specified number of frames.

- a. The default value is 0 which represents the top-left corner of the active picture area.  
 b. This option is only applicable when an animation file is selected.  
 c. This option is only applicable when an animation file is selected.  
 d. The Play Mode feature only applies to interlaced video formats and has no effect when using progressive video formats.  
 e. The default value is 0.

## External Keys Tab

**Table 57** summarizes the **External Keys** tab options available in DashBoard.

**Table 57 External Keys Tab Items**

Item	Parameters	Description
<b>External Key #</b>		
#		Selecting a button sets that video source as the External source. The default External Source for the External Key is Black.

## Audio Processing Tab

**Table 58** summarizes the options displayed in each Audio Processing sub-tab.

**Table 58 Audio Processing Tab — Audio #-#**

Item	Parameters	Description
On Preset:	#	Indicates the crosspoint currently selected on the Preset Bus
Load Profile	#	Applies the audio settings of the selected profile to the currently selected Preset crosspoint on the next transition
<b>Ch 1-8, Ch 9-16</b>		
Reset		Resets all Audio Output settings for the applicable audio group to the factory default values
Mute	Selected	Mutes the input source for the specified channel that is inserted into the embedded group (if present)
	Cleared	The input source for the specified channel is not muted
Gain (dB)	#	Adjusts the gain of the specified channel of audio Select 0 when using non-PCM audio
Invert	Selected	Inverts the audio signal of the specified group
	Cleared	<ul style="list-style-type: none"> <li>• Audio signal of the specified group is not inverted</li> <li>• Use for non-PCM audio data</li> </ul>
Sum	Selected	Both channels will carry the average of the two input channels $((A+B)/2)$
	Cleared	Disables this feature

## Audio Shuffle Tab

**Table 59** summarizes the options displayed in each Audio Shuffle tab.

**Table 59 Audio Shuffle Tab**

Item	Parameters	Description
On Preset:	#	Indicates the crosspoint currently selected on the Preset Bus
Load Profile	#	Applies the audio settings of the selected profile to the currently selected Preset crosspoint on the next transition
<b>Group #</b>		
Ch # Source	Group # Ch #	Specifies the input for the specified channel that is inserted into the embedded group (if present)
	#kHz Tone	Embeds the selected test tone

**Table 59 Audio Shuffle Tab**

Item	Parameters	Description
Pass		Resets the specified group settings to pass the default input channels to the output channels. The mute, gain, sum, and invert settings for the specific group are reset to the default values.
Pass All		Resets all group settings to pass the default input channels to the output channels. The mute, gain, sum, and invert settings for all groups are reset to the default values.

## Save Audio Profile Tab

**Table 60** summarizes the options on the **Save Audio Profile** tab.

**Table 60 Save Audio Profile Tab**

Item	Parameters	Description
On Preset:	#	Indicates the crosspoint currently selected on the Preset Bus
Save Profile	<text>	Saves the current audio shuffle and processing settings to the selected profile.

## Voice Over Tab

**Table 61** summarizes the **Voice Over** tab options available in DashBoard.

**Table 61 Voice Over Tab**

Item	Parameters	Description
Duck Level (dB)	# <sup>a</sup>	This ducks the Voice Over source and the input audio. The AUDIO OVER button is lit.
Gain (dB)	# <sup>b</sup>	This applies a gain to the Voice Over source and the input audio. The AUDIO OVER button is lit.

a. The default is -10dB.

b. The default is 0dB.

## GPIO Control Tab

**Table 61** summarizes the **Voice Over** tab options available in DashBoard.

**Table 62 GPIO Control Tab**

Item	Parameters	Description
<b>GPI/Tally #</b>		
Function (read-only)		Reports the transition event assigned to a specific GPI port
Current State (read-only)		Reports the port status



**Table 62 GPIO Control Tab**

Item	Parameters	Description
Set Level <sup>a</sup>	High	The output toggles from the base low level to the high level. The output signal remains at this level until reset.
	Low	The output level toggles from the base high level to the low level. The output signal remains at this level until reset.

a. The Manual Override option must be enabled on the Configuration > GPI/Tally > GPI/Tally tab for the Set Level button to take effect.

## Control Panel

This area is used to select the video sources for each bus. Each crosspoint button will display the name of its source on the button face.

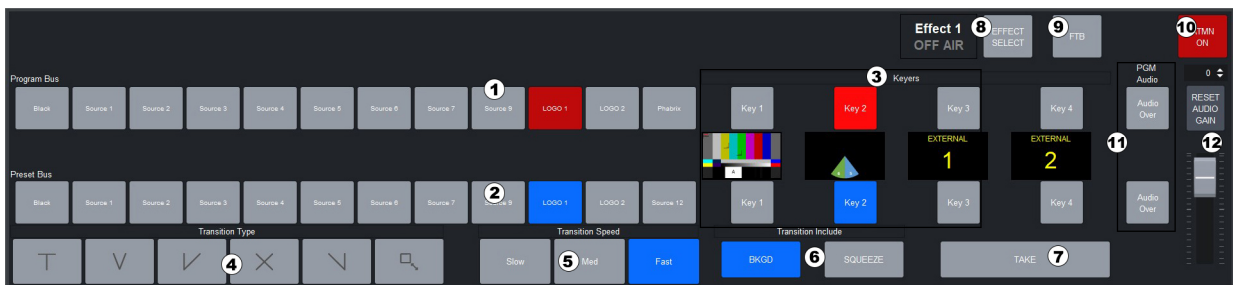

*Figure 27 Example of the Control Panel*

### 1. Program Bus

The Program Bus is used to select the video source that will display as the Background on the Program output.

### 2. Preset Bus

The Preset Bus is used to select the video source that displays on the Preview output.

### 3. Keyers Area



The Keyer Area enables you to add, or remove, keyers in transitions. This area includes the following controls:

The top row of buttons, labeled Key 1-4 and lit in red, are used to perform cuts on the specified keyer directly on the Program Bus, without affecting their inclusion in the next transition. A lit button indicates that the specified keyer is currently on-air.





The bottom row of buttons, labeled Key 1-4 and lit in blue, are used to add, or remove, the specified keyer to the next transition. Selecting the button toggles the keyer on/off and selects/removes the keyer to the Preset Bus respectively. Once the transition is executed, and depending on the Configuration > Transitions > Transition Behavior setting, the button(s) are no longer lit in this row but are lit red in the top row.

### 4. Transition Type Buttons

The following Transition Type buttons are available (from left to right):

- >  (Cut) — Select this button to perform a cut transition from one source to the next.
- >  (V-Fade) — Select this button to perform a V-Fade transition from the Program source to Black to the Preset source. The MC1-UHD fades down from one source to black and then

transitions to the next source. During a hot-punch transition, the video performs a CUT while the audio performs a V-Fade.

- ›  (Cut-Fade) — Select this button to perform a cut to black, then fade up to the next source.
- ›  (Cross Fade) — Select this button to perform a gradual fade from one source to the next. The MC1-UHD performs a cross fade between sources. Note that this button is selected after performing a factory default reset.
- ›  (Fade-Cut) — Select this button to fade from one source to black and then cut to the next source.
- ›  (SqueezeBack) — Select this button to perform a SqueezeBack effect by reducing the size of the video over time to the dimensions set in the SqueezeBack Effects tab. Unlike the above types, you may not change your background on-air with this transition type, but you can change keys on-air. The corresponding buttons are grayed out. This button displays only when the MC1-UHD-DVE-1CH-LICENSE license key is installed.

### 5. Transition Speed Buttons

These buttons apply the rate (slow, medium, fast) to the next transition. The transition rates are specified in the **Home** tab.

- ★ The **Slow** button is selected after performing a factory default reset.
- ★ If you are controlling the MC1-UHD via Automation, and these buttons are not lit, the transition rate applied is set by the Automation command. If you wish to apply one of these rates, remember to select the required transition speed button before performing a transition (e.g. selecting TAKE).

### 6. Transition Include Buttons

- › **BKGD** — This button is used to add/remove the Preset source to/from the next transition. Toggling this button will immediately affect the video that is visible on the Preset output.
- › **SQUEEZE** — This button is used to add/remove the SqueezeBack effect to/from the next transition. Toggling this button will immediately affect the video that is visible on the Preset output. This button displays only when the MC1-UHD-DVE-1CH-LICENSE license key is installed.

### 7. TAKE Button

Selecting the **TAKE** button performs the transition between the sources and effects selected in the Program and Preset buses, using the specified Transition Type and Transition Speed.

### 8. EFFECT SELECT

This area includes the Effect # status field and an **EFFECT SELECT** button. The status field reports the last applied effect and whether it is on or off air, or currently on the Preset Bus.

- ★ The MC1-UHD-DVE-1CH-LICENSE is required.

While the squeeze effect is on air:

- › the **EFFECT SELECT** button is locked. Even though you can still adjust the options in the SqueezeBack Effects tabs, we suggest not doing so since all effect changes are immediately applied.
- › you are unable to change the background or keys with a transition. However, you can still hot-punch a source or key on the Program bus. However, hot-punching a source on the Program bus will take the squeeze effect off air. Hot-punching keys on/off will not take the squeeze effect off air.
- › you can perform any hot-punch or **TAKE** transition inside of the squeeze effect.

## 9. FTB Button

Use this button to fade the Program bus to black. The Fade to Black (FTB) rate is specified in the Home tab. After performing a factory default reset, this button is toggled off (unlit). This button can be disabled via the FTB Disabling option on the Transitions tab (refer to **Table 37**).

## 10.ATMN Button

Toggling this button on (button will be lit) allows an Automation System to control the MC1-UHD. After performing a factory default reset, this button is toggled off (unlit).

## 11.AUDIO OVER Buttons

An **AUDIO OVER** button is included on each bus. Selecting the button in the Preview bus includes the voice over channel in the next transition. You can also hot-punch the **AUDIO OVER** button in the Program bus.

## 12.Program Audio Area

This area includes an audio fader that enables you to control the Program audio gain. The slider is set by default to 0 and has a range of -72 to +20dB. Use the **Reset Audio Gain** button to reset the audio gain.



# Technical Specifications

This chapter provides technical information for MC1-UHD.

★ Specifications are subject to change without notice.

## Supported Video Formats

**Table 63 Technical Specifications — Supported Video Formats**

Resolution (lines)	Frame Rate (Hz)
480i	59.94
576i	50
720p	50
	59.94
1080i	50
	59.94
1080p	50
	59.94
1080pSF	23.98
	24
2160p <sup>a</sup>	23.98
	24
	25
	29.97
	30
	50
	59.94

a. Requires the MC1-UHD-12G-LICENSE.

## SDI Inputs Specifications

**Table 64 Technical Specifications — SDI Inputs**

Item	Specifications
Number of Inputs	6
Standards Accommodated	270Mbps, 525/625 Component, SMPTE 259M
	1.485Gbps Component, SMPTE 292M
	2.97Gbps Component, SMPTE 424M
	5.94Gbps Component, SMPTE ST-2081
	11.88Gbps Component, SMPTE 2082
Impedance	75ohm

**Table 64 Technical Specifications — SDI Inputs**

Item	Specifications
Return Loss	to 270Mbps
	>15dB to 1.485Gbps
	>10dB to 2.97Gbps
	>7dB to 5.94Gbps
	>4dB to 11.88Gbps
Equalization (Belden 1694A cable)	@ 270Mbps
	>220m (722ft) @ 1.485Gbps
	>140m (459ft) @ 2.97Gbps
	>50m (190ft) @ 11.88Gbps
Connection	HD-BNC

## SDI Outputs Specifications

**Table 65 Technical Specifications — SDI Outputs**

Item	Specifications
Number of Outputs	6
Impedance	75ohm
Return Loss	to 270Mbps
	>15dB to 1.485Gbps
	>10dB to 2.97Gbps
	>7dB to 5.94Gbps
	>4dB to 11.88Gbps
Signal Level	800mV ±10%
DC Offset	0V ±50mV
Rise and Fall Time (20-80%)	270Mbps:
	1.485Gbps: <270ps, <100ps difference
	2.97Gbps: <135ps, <50ps difference
	11.88Gbps: <45ps, <18ps difference
Jitter	270Mbps:
	1.485Gbps: <1.0UI jitter measured 10Hz-100kHz, <0.2UI above 100kHz
	2.97Gbps: <1.0UI jitter measured 10Hz-100kHz, <0.3UI above 100kHz
	11.88Gbps: <2.0UI jitter measured 10Hz-100kHz, <0.3UI above 100kHz, band limit @1188MHz
Overshoot	<10% (11.88Gbps: <15%)
Connection	HD-BNC

# AES Specifications

## MC1-UHD-A

**Table 66 AES Specifications — MC1-UHD-A**

Item	Specifications
AES Standards Accommodated	AES-3id-2001, AES3
Connector Type	HD-BNC
<b>Inputs</b>	
Impedance	75ohm
Minimum Input	50mV p-p
Maximum Input	2.5V p-p @ 48kHz
	1.5V p-p @ 96kHz
Minimum Audio Delay	SRC ON: 2ms
	SRC OFF: 1ms
Maximum Audio Delay	1365 ms
Sampling Rate	48kHz compliant with AES-3id or any rate from 32kHz to 96kHz with SRC on
Equalization	up to 800m (2,400ft) @ 48kHz
	up to 500m (1,500ft) @ 96kHz
<b>Outputs</b>	
Impedance	75ohm
Output Level	1V p-p
Sampling Rate	48kHz

## MC1-UHD-B

**Table 67 AES Specifications — MC1-UHD-B**

Item	Specifications
AES Standards Accommodated	AES-3id-2001, AES3
Connector Type	WECO
Impedance	110ohm
Minimum Input	100mV p-p
Maximum Input	10V p-p
Minimum Audio Delay	SRC ON: 2ms
	SRC OFF: 1ms
Maximum Audio Delay	1365 ms
Sampling Rate	48kHz compliant with AES-3id or any rate from 32kHz to 96kHz with SRC on

**Table 67 AES Specifications — MC1-UHD-B**

Item	Specifications
Equalization	>450m of Belden 1492 cable
Return Loss	>26dB 100KHz to 6MHz
Output Amplitude	4Vp-p
Rise and Fall Times	30ns
Jitter	4.5mUI

## Serial Port Specifications

★ This section applies only to the R3B-GATOR (8322AR-318D) or R3A-GATOR (8322AR-391C). The R4-GATOR (8323AR-325) does not include a **SERIAL** port.

**Table 68 Technical Specifications — Serial Port**

Item	Specifications
<b>Maximum Cable Lengths</b>	
RS-232 Serial Interface	10m (33ft)
RS-422 Serial Interface	300m (984ft)

Refer to **Table 69** and **Figure 28** for pin-outs for the **SERIAL** port on the MC1-UHD rear modules.

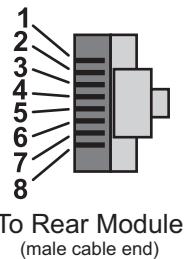

*Figure 28 Serial Port Pinouts*

**Table 69 Serial Pinouts on the MC1-UHD**

RJ45 Pin	RS-232	RS-422
1	n/c	Tx+
2	Rx	Tx-
3	Tx	Rx+
4	n/c	n/c
5	n/c	n/c
6	n/c	Rx-
7	GND	GND
8	GND	GND



## GPIO

**Table 70 Technical Specifications — GPIO**

Item	Specifications
Absolute Maximum Voltage at Connector Pins	1.0V to +6.0V to prevent damage
<b>GPI</b>	
Input	<ul style="list-style-type: none"><li>• 4.7K ohm resistor pull-up to 5V for High</li><li>• GND contact closure (or external logic) for Low</li><li>• High In is <math>\geq 2.5V</math></li><li>• Low In is <math>\leq 0.5V</math></li></ul>
<b>Tally</b>	
Output	<ul style="list-style-type: none"><li>• Pulled to 5V with 4k7 ohm resistor for High</li><li>• Driven to ground or Low through 30ohms</li><li>• Maximum sink current 50mA to drive an external relay</li><li>• To drive a logic gate input, sink current needs to be below 10mA (0.3V at pin)</li></ul>

## Environment

**Table 71 Technical Specifications — Environment**

Item	Specifications
Maximum Ambient Temperature	40°C (104°F)

## Power

**Table 72 Technical Specifications — Power**

Item	Specifications
Maximum Power Consumption	40W-80W (application dependent)



# Service Information

Routine maintenance to this openGear product is not required. In the event of problems with your card, the following basic troubleshooting checklist may help identify the source of the problem. If the frame still does not appear to be working properly after checking all possible causes, please contact your openGear products distributor, or the Technical Support department at the numbers listed under the “**Contacting Technical Support**”.

1. **Visual Review** — Performing a quick visual check may reveal many problems, such as connectors not properly seated or loose cables. Check the card, the frame, and any associated peripheral equipment for signs of trouble.
2. **Power Check** — Inspect the power indicator LED on the distribution frame front panel for the presence of power. If the power LED is not illuminated, verify that the power cable is connected to a power source and that power is available at the power main. Confirm that the power supplies are fully seated in their slots. If the power LED is still not illuminated, replace the power supply with one that is verified to work.
3. **Input Signal Status** — Verify that source equipment is operating correctly and that a valid signal is being supplied.
4. **Output Signal Path** — Verify that destination equipment is operating correctly and receiving a valid signal.
5. **Unit Exchange** — Exchanging a suspect unit with a unit that is known to be working correctly is an efficient method for localizing problems to individual units.

## Reloading the Software on the Card

In the unlikely event of a complete card failure, you may be instructed by a Ross Technical Support specialist to perform a complete software reload on the card.

### To reload the software on the card

1. Eject the card from the frame.
2. Press and hold the **Bootload** button, while re-inserting the card into the frame.
3. Release the button.
  - The **OK/ERROR** LED flashes green while the card is waiting for a new software load.
  - If a new software load is not sent to the card within 60 seconds, the card will attempt to re-start with its last operational software load.
  - Software loads can be sent to the card via the connection on the rear of the frame.

## Loading the Factory Defaults

If required, the card menu parameters can be reset to the factory default values using the option available in the **Setup** tab. All parameters are reset except those listed in **Table 14.16**.

### To reset the card to the factory default settings in Dashboard

1. Navigate to the **Global** interface as outlined in “**To display the Global interface in Dashboard**”.
2. Select the **Setup** tab.
3. Click **Load Factory Defaults** to display the **Confirm** dialog.
4. Click **Yes** to load the factory default values for all menu parameters, or **No** to cancel the load and close the dialog.

- ★ To ensure that the DashBoard fields display the updated settings, it is recommended to click the **Refresh** button, located at the bottom of the DashBoard window, after the factory defaults are fully loaded.

## Warranty and Repair Policy

The MC1-UHD is warranted to be free of any defect with respect to performance, quality, reliability, and workmanship for a period of FIVE (5) years from the date of shipment from our factory. In the event that your card proves to be defective in any way during this warranty period, Ross Video Limited reserves the right to repair or replace this piece of equipment with a unit of equal or superior performance characteristics.

Should you find that this card has failed after your warranty period has expired, we will repair your defective product should suitable replacement components be available. You, the owner, will bear any labor and/or part costs incurred in the repair or refurbishment of said equipment beyond the FIVE (5) year warranty period.

In no event shall Ross Video Limited be liable for direct, indirect, special, incidental, or consequential damages (including loss of profits) incurred by the use of this product. Implied warranties are expressly limited to the duration of this warranty.

This User Manual provides all pertinent information for the safe installation and operation of your openGear product. Ross Video policy dictates that all repairs to the card are to be conducted only by an authorized Ross Video Limited factory representative. Therefore, any unauthorized attempt to repair this product, by anyone other than an authorized Ross Video Limited factory representative, will automatically void the warranty. Please contact Ross Video Technical Support for more information.

### In Case of Problems

Should any problem arise with your card, please contact the Ross Video Technical Support Department. (Contact information is supplied at the end of this publication.)

A Return Material Authorization number (RMA) will be issued to you, as well as specific shipping instructions, should you wish our factory to repair your card. If required, a temporary replacement frame will be made available at a nominal charge. Any shipping costs incurred will be the responsibility of you, the customer. All products shipped to you from Ross Video Limited will be shipped collect.

The Ross Video Technical Support Department will continue to provide advice on any product manufactured by Ross Video Limited, beyond the warranty period without charge, for the life of the equipment.

# Software Licenses

This chapter provides third-party software license information for your MC1-UHD. This product includes multiple software components which are individually licensed under one or more of the following licenses included in this chapter.

## BSD

Copyright (c) 1991,1993, The Regents of the University of California. All rights reserved.

This code is derived from software contributed to Berkeley by Kenneth Almquist.

Redistribution and use in source and binary forms, with or without modification, are permitted provided that the following conditions are met:

1. Redistributions of source code must retain the above copyright notice, this list of conditions and the following disclaimer.
2. Redistributions in binary form must reproduce the above copyright notice, this list of conditions and the following disclaimer in the documentation and/or other materials provided with the distribution.
3. <BSD Advertising Clause omitted per the July 22, 1999 licensing change <ftp://ftp.cs.berkeley.edu/pub/4bsd/README.Impt.License.Change>> California, Berkeley and its contributors.
4. Neither the name of the University nor the names of its contributors may be used to endorse or promote products derived from this software without specific prior written permission.

THIS SOFTWARE IS PROVIDED BY THE REGENTS AND CONTRIBUTORS "AS IS" AND ANY EXPRESS OR IMPLIED WARRANTIES, INCLUDING, BUT NOT LIMITED TO, THE IMPLIED WARRANTIES OF MERCHANTABILITY AND FITNESS FOR A PARTICULAR PURPOSE ARE DISCLAIMED. IN NO EVENT SHALL THE REGENTS OR CONTRIBUTORS BE LIABLE FOR ANY DIRECT, INDIRECT, INCIDENTAL, SPECIAL, EXEMPLARY, OR CONSEQUENTIAL DAMAGES (INCLUDING, BUT NOT LIMITED TO, PROCUREMENT OF SUBSTITUTE GOODS OR SERVICES; LOSS OF USE, DATA, OR PROFITS; OR BUSINESS INTERRUPTION) HOWEVER CAUSED AND ON ANY THEORY OF LIABILITY, WHETHER IN CONTRACT, STRICT LIABILITY, OR TORT (INCLUDING NEGLIGENCE OR OTHERWISE) ARISING IN ANY WAY OUT OF THE USE OF THIS SOFTWARE, EVEN IF ADVISED OF THE POSSIBILITY OF SUCH DAMAGE.

## Dual GPL

Portions of this software are copyright (C) 1996-2002 The FreeType Project ([www.freetype.org](http://www.freetype.org)). All rights reserved.

This project is also covered under the GPL v2.

## GPL

GNU GENERAL PUBLIC LICENSE  
Version 3, 29 June 2007  
Copyright (C) 2007 Free Software Foundation, Inc. <<http://fsf.org/>>  
Preamble

The GNU General Public License is a free, copyleft license for software and other kinds of works.

The licenses for most software and other practical works are designed to take away your freedom to share and change the works. By contrast, the GNU General Public License is intended to guarantee your freedom to share and change all versions of a program—to make sure it remains free software for all its users. We, the Free Software Foundation, use the GNU General Public License for most of our software; it applies also to any other work released this way by its authors. You can apply it to your programs, too.

When we speak of free software, we are referring to freedom, not price. Our General Public Licenses are designed to make sure that you have the freedom to distribute copies of free software (and charge for them if you wish), that you receive source code or can get it if you want it, that you can change the software or use pieces of it in new free programs, and that you know you can do these things.

To protect your rights, we need to prevent others from denying you these rights or asking you to surrender the rights. Therefore, you have certain responsibilities if you distribute copies of the software, or if you modify it: responsibilities to respect the freedom of others.

For example, if you distribute copies of such a program, whether gratis or for a fee, you must pass on to the recipients the same freedoms that you received. You must make sure that they, too, receive or can get the source code. And you must show them these terms so they know their rights.

Developers that use the GNU GPL protect your rights with two steps: (1) assert copyright on the software, and (2) offer you this License giving you legal permission to copy, distribute and/or modify it.

For the developers' and authors' protection, the GPL clearly explains that there is no warranty for this free software. For both users' and authors' sake, the GPL requires that modified versions be marked as changed, so that their problems will not be attributed erroneously to authors of previous versions.

Some devices are designed to deny users access to install or run modified versions of the software inside them, although the manufacturer can do so. This is fundamentally incompatible with the aim of protecting users' freedom to change the software. The systematic pattern of such abuse occurs in the area of products for individuals to use, which is precisely where it is most unacceptable. Therefore, we have designed this version of the GPL to prohibit the practice for those products. If

such problems arise substantially in other domains, we stand ready to extend this provision to those domains in future versions of the GPL, as needed to protect the freedom of users.

Finally, every program is threatened constantly by software patents. States should not allow patents to restrict development and use of software on general-purpose computers, but in those that do, we wish to avoid the special danger that patents applied to a free program could make it effectively proprietary. To prevent this, the GPL assures that patents cannot be used to render the program non-free.

The precise terms and conditions for copying, distribution and modification follow.

## TERMS AND CONDITIONS

### 0. Definitions.

"This License" refers to version 3 of the GNU General Public License.

"Copyright" also means copyright-like laws that apply to other kinds of works, such as semiconductor masks.

"The Program" refers to any copyrightable work licensed under this License. Each licensee is addressed as "you". "Licensees" and "recipients" may be individuals or organizations.

To "modify" a work means to copy from or adapt all or part of the work in a fashion requiring copyright permission, other than the making of an exact copy. The resulting work is called a "modified version" of the earlier work or a work "based on" the earlier work.

A "covered work" means either the unmodified Program or a work based on the Program.

To "propagate" a work means to do anything with it that, without permission, would make you directly or secondarily liable for infringement under applicable copyright law, except executing it on a computer or modifying a private copy. Propagation includes copying, distribution (with or without modification), making available to the public, and in some countries other activities as well.

To "convey" a work means any kind of propagation that enables other parties to make or receive copies. Mere interaction with a user through a computer network, with no transfer of a copy, is not conveying.

An interactive user interface displays "Appropriate Legal Notices" to the extent that it includes a convenient and prominently visible feature that (1) displays an appropriate copyright notice, and (2) tells the user that there is no warranty for the work (except to the extent that warranties are provided), that licensees may convey the work under this License, and how to view a copy of this License. If the interface presents a list of user commands or options, such as a menu, a prominent item in the list meets this criterion.

### 1. Source Code.

The "source code" for a work means the preferred form of the work for making modifications to it. "Object code" means any non-source form of a work.

A "Standard Interface" means an interface that either is an official standard defined by a recognized standards body, or, in the case of interfaces specified for a particular programming language, one that is widely used among developers working in that language.

The "System Libraries" of an executable work include anything, other than the work as a whole, that (a) is included in the normal form of packaging a Major Component, but which is not part of that Major Component, and (b) serves only to enable use of the work with that Major Component, or to implement a Standard Interface for which an implementation is available to the public in source code form. A "Major Component", in this context, means a major essential component (kernel, window system, and so on) of the specific operating system (if any) on which the executable work runs, or a compiler used to produce the work, or an object code interpreter used to run it.

The "Corresponding Source" for a work in object code form means all the source code needed to generate, install, and (for an executable work) run the object code and to modify the work, including scripts to control those activities. However, it does not include the work's System Libraries, or general-purpose tools or generally available free programs which are used unmodified in performing those activities but which are not part of the work. For example, Corresponding Source includes interface definition files associated with source files for the work, and the source code for shared libraries and dynamically linked subprograms that the work is specifically designed to require, such as by intimate data communication or control flow between those subprograms and other parts of the work.

The Corresponding Source need not include anything that users can regenerate automatically from other parts of the Corresponding Source.

The Corresponding Source for a work in source code form is that same work.

### 2. Basic Permissions.

All rights granted under this License are granted for the term of copyright on the Program, and are irrevocable provided the stated conditions are met. This License explicitly affirms your unlimited permission to run the unmodified Program. The output from running a covered work is covered by this License only if the output, given its content, constitutes a covered work. This License acknowledges your rights of fair use or other equivalent, as provided by copyright law.

You may make, run and propagate covered works that you do not convey, without conditions so long as your license otherwise remains in force. You may convey covered works to others for the sole purpose of having them make modifications exclusively for you, or provide you with facilities for running those works, provided that you comply with the terms of this License in conveying all material for which you do not control copyright. Those thus making or running the covered works for you must do so exclusively on your behalf, under your direction and control, on terms that prohibit them from making any copies of your copyrighted material outside their relationship with you.

Conveying under any other circumstances is permitted solely under the conditions stated below. Sublicensing is not allowed; section 10 makes it unnecessary.

### 3. Protecting Users' Legal Rights From Anti-Circumvention Law.

No covered work shall be deemed part of an effective technological measure under any applicable law fulfilling obligations under article 11 of the WIPO copyright treaty adopted on 20 December 1996, or similar laws prohibiting or restricting circumvention of such measures.

When you convey a covered work, you waive any legal power to forbid circumvention of technological measures to the extent such circumvention is effected by exercising rights under this License with respect to the covered work, and you disclaim any intention to limit operation or modification of the work as a means of enforcing, against the work's users, your or third parties' legal rights to forbid circumvention of technological measures.

### 4. Conveying Verbatim Copies.

You may convey verbatim copies of the Program's source code as you receive it, in any medium, provided that you conspicuously and appropriately publish on each copy an appropriate copyright notice; keep intact all notices stating that this License and any non-permissive terms added in accord with section 7 apply to the code; keep intact all notices of the absence of any warranty; and give all recipients a copy of this License along with the Program.

You may charge any price or no price for each copy that you convey, and you may offer support or warranty protection for a fee.

### 5. Conveying Modified Source Versions.

You may convey a work based on the Program, or the modifications to produce it from the Program, in the form of source code under the terms of section 4, provided that you also meet all of these conditions:

- a. The work must carry prominent notices stating that you modified it, and giving a relevant date.
- b. The work must carry prominent notices stating that it is released under this License and any conditions added under section 7. This requirement modifies the requirement in section 4 to "keep intact all notices".
- c. You must license the entire work, as a whole, under this License to anyone who comes into possession of a copy. This License will therefore apply, along with any applicable section 7 additional terms, to the whole of the work, and all its parts, regardless of how they are packaged. This License gives no permission to license the work in any other way, but it does not invalidate such permission if you have separately received it.
- d. If the work has interactive user interfaces, each must display Appropriate Legal Notices; however, if the Program has interactive interfaces that do not display Appropriate Legal Notices, your work need not make them do so.

A compilation of a covered work with other separate and independent works, which are not by their nature extensions of the covered work, and which are not combined with it such as to form a larger program, in or on a volume of a storage or distribution medium, is called an "aggregate" if the compilation and its resulting copyright are not used to limit the access or legal rights of the compilation's users beyond what the individual works permit. Inclusion of a covered work in an aggregate does not cause this License to apply to the other parts of the aggregate.

### 6. Conveying Non-Source Forms.

You may convey a covered work in object code form under the terms of sections 4 and 5, provided that you also convey the machine-readable Corresponding Source under the terms of this License, in one of these ways:

- a. Convey the object code in, or embodied in, a physical product (including a physical distribution medium), accompanied by the Corresponding Source fixed on a durable physical medium customarily used for software interchange.
- b. Convey the object code in, or embodied in, a physical product (including a physical distribution medium), accompanied by a written offer, valid for at least three years and valid for as long as you offer spare parts or customer support for that product model, to give anyone who possesses the object code either (1) a copy of the Corresponding Source for all the software in the product that is covered by this License, on a durable physical medium customarily used for software interchange, for a price no more than your reasonable cost of physically performing this conveying of source, or (2) access to copy the Corresponding Source from a network server at no charge.
- c. Convey individual copies of the object code with a copy of the written offer to provide the Corresponding Source. This alternative is allowed only occasionally and noncommercially, and only if you received the object code with such an offer, in accord with subsection 6b.
- d. Convey the object code by offering access from a designated place (gratis or for a charge), and offer equivalent access to the Corresponding Source in the same way through the same place at no further charge. You need not require recipients to copy the Corresponding Source along with the object code. If the place to copy the object code is a network server, the Corresponding Source may be on a different server (operated by you or a third party) that supports equivalent copying facilities, provided you maintain clear directions next to the object code saying where to find the Corresponding Source. Regardless of what server hosts the Corresponding Source, you remain obligated to ensure that it is available for as long as needed to satisfy these requirements.
- e. Convey the object code using peer-to-peer transmission, provided you inform other peers where the object code and Corresponding Source of the work are being offered to the general public at no charge under subsection 6d.

A separable portion of the object code, whose source code is excluded from the Corresponding Source as a System Library, need not be included in conveying the object code work.

A "User Product" is either (1) a "consumer product", which means any tangible personal property which is normally used for personal, family, or household purposes, or (2) anything designed or sold for incorporation into a dwelling. In determining whether a product is a consumer product, doubtful cases shall be resolved in favor of coverage. For a particular product received by a particular user, "normally used" refers to a typical or common use of that class of product, regardless of the status of the particular user or of the way in which the particular user actually uses, or expects or is expected to use, the product. A product is a consumer product regardless of whether the product has substantial commercial, industrial or non-consumer uses, unless such uses represent the only significant mode of use of the product.

"Installation Information" for a User Product means any methods, procedures, authorization keys, or other information required to install and execute modified versions of a covered work in that User Product from a modified version of its Corresponding Source. The information must suffice to ensure that the continued functioning of the modified object code is in no case prevented or interfered with solely because modification has been made.

If you convey an object code work under this section in, or with, or specifically for use in, a User Product, and the conveying occurs as part of a transaction in which the right of possession and use of the User Product is transferred to the recipient in perpetuity or for a fixed term (regardless of how the transaction is characterized), the Corresponding Source conveyed under this section must be accompanied by the Installation Information. But this requirement does not apply if neither you nor any third party retains the ability to install modified object code on the User Product (for example, the work has been installed in ROM).

The requirement to provide Installation Information does not include a requirement to continue to provide support service, warranty, or updates for a work that has been modified or installed by the recipient, or for the User Product in which it has been modified or installed. Access to a network may be denied when the modification itself materially and adversely affects the operation of the network or violates the rules and protocols for communication across the network.

Corresponding Source conveyed, and Installation Information provided, in accord with this section must be in a format that is publicly documented (and with an implementation available to the public in source code form), and must require no special password or key for unpacking, reading or copying.

### 7. Additional Terms.

"Additional permissions" are terms that supplement the terms of this License by making exceptions from one or more of its conditions. Additional permissions that are applicable to the entire Program shall be treated as though they were included in this License, to the extent that they are valid under applicable law. If additional permissions apply only to part of the Program, that part may be used separately under those permissions, but the entire Program remains governed by this License without regard to the additional permissions.

When you convey a copy of a covered work, you may at your option remove any additional permissions from that copy, or from any part of it. (Additional permissions may be written to require their own removal in certain cases when you modify the work.) You may place additional permissions on material, added by you to a covered work, for which you have or can give appropriate copyright permission.

Notwithstanding any other provision of this License, for material you add to a covered work, you may (if authorized by the copyright holders of that material) supplement the terms of this License with terms:

- a. Disclaiming warranty or limiting liability differently from the terms of sections 15 and 16 of this License; or
- b. Requiring preservation of specified reasonable legal notices or author attributions in that material or in the Appropriate Legal Notices displayed by works containing it; or
- c. Prohibiting misrepresentation of the origin of that material, or requiring that modified versions of such material be marked in reasonable ways as different from the original version; or
- d. Limiting the use for publicity purposes of names of licensors or authors of the material; or
- e. Declining to grant rights under trademark law for use of some trade names, trademarks, or service marks; or
- f. Requiring indemnification of licensors and authors of that material by anyone who conveys the material (or modified versions of it) with contractual assumptions of liability to the recipient, for any liability that these contractual assumptions directly impose on those licensors and authors.

All other non-permissive additional terms are considered "further restrictions" within the meaning of section 10. If the Program as you received it, or any part of it, contains a notice stating that it is governed by this License along with a term that is a further restriction, you may remove that term. If a license document contains a further restriction but permits relicensing or conveying under this License, you may add to a covered work material governed by the terms of that license document, provided that the further restriction does not survive such relicensing or conveying.

If you add terms to a covered work in accord with this section, you must place, in the relevant source files, a statement of the additional terms that apply to those files, or a notice indicating where to find the applicable terms.

Additional terms, permissive or non-permissive, may be stated in the form of a separately written license, or stated as exceptions; the above requirements apply either way.

## **8. Termination.**

You may not propagate or modify a covered work except as expressly provided under this License. Any attempt otherwise to propagate or modify it is void, and will automatically terminate your rights under this License (including any patent licenses granted under the third paragraph of section 11).

However, if you cease all violation of this License, then your license from a particular copyright holder is reinstated (a) provisionally, unless and until the copyright holder explicitly and finally terminates your license, and (b) permanently, if the copyright holder fails to notify you of the violation by some reasonable means prior to 60 days after the cessation.

Moreover, your license from a particular copyright holder is reinstated permanently if the copyright holder notifies you of the violation by some reasonable means, this is the first time you have received notice of violation of this License (for any work) from that copyright holder, and you cure the violation prior to 30 days after your receipt of the notice.

Termination of your rights under this section does not terminate the licenses of parties who have received copies or rights from you under this License. If your rights have been terminated and not permanently reinstated, you do not qualify to receive new licenses for the same material under section 10.

## **9. Acceptance Not Required for Having Copies.**

You are not required to accept this License in order to receive or run a copy of the Program. Ancillary propagation of a covered work occurring solely as a consequence of using peer-to-peer transmission to receive a copy likewise does not require acceptance. However, nothing other than this License grants you permission to propagate or modify any covered work. These actions infringe copyright if you do not accept this License. Therefore, by modifying or propagating a covered work, you indicate your acceptance of this License to do so.

## **10. Automatic Licensing of Downstream Recipients.**

Each time you convey a covered work, the recipient automatically receives a license from the original licensors, to run, modify and propagate that work, subject to this License. You are not responsible for enforcing compliance by third parties with this License.

An "entity transaction" is a transaction transferring control of an organization, or substantially all assets of one, or subdividing an organization, or merging organizations. If propagation of a covered work results from an entity transaction, each party to that transaction who receives a copy of the work also receives whatever licenses to the work the party's predecessor in interest had or could give under the previous paragraph, plus a right to possession of the Corresponding Source of the work from the predecessor in interest, if the predecessor has it or can get it with reasonable efforts.

You may not impose any further restrictions on the exercise of the rights granted or affirmed under this License. For example, you may not impose a license fee, royalty, or other charge for exercise of rights granted under this License, and you may not initiate litigation (including a cross-claim or counterclaim in a lawsuit) alleging that any patent claim is infringed by making, using, selling, offering for sale, or importing the Program or any portion of it.

## **11. Patents.**

A "contributor" is a copyright holder who authorizes use under this License of the Program or a work on which the Program is based. The work thus licensed is called the contributor's "contributor version".

A contributor's "essential patent claims" are all patent claims owned or controlled by the contributor, whether already acquired or hereafter acquired, that would be infringed by some manner, permitted by this License, of making, using, or selling its contributor version, but do not include claims that would be infringed only as a consequence of further modification of the contributor version. For purposes of this definition, "control" includes the right to grant patent sublicenses in a manner consistent with the requirements of this License.

Each contributor grants you a non-exclusive, worldwide, royalty-free patent license under the contributor's essential patent claims, to make, use, sell, offer for sale, import and otherwise run, modify and propagate the contents of its contributor version.

In the following three paragraphs, a "patent license" is any express agreement or commitment, however denominated, not to enforce a patent (such as an express permission to practice a patent or covenant not to sue for patent infringement). To "grant" such a patent license to a party means to make such an agreement or commitment not to enforce a patent against the party.

If you convey a covered work, knowingly relying on a patent license, and the Corresponding Source of the work is not available for anyone to copy, free of charge and under the terms of this License, through a publicly available network server or other readily accessible means, then you must either (1) cause the Corresponding Source to be so available, or (2) arrange to deprive yourself of the benefit of the patent license for this particular work, or (3) arrange, in a manner consistent with the requirements of this License, to extend the patent license to downstream recipients. "Knowingly relying" means you have actual knowledge that, but for the patent



license, your conveying the covered work in a country, or your recipient's use of the covered work in a country, would infringe one or more identifiable patents in that country that you have reason to believe are valid.

If, pursuant to or in connection with a single transaction or arrangement, you convey, or propagate by procuring conveyance of, a covered work, and grant a patent license to some of the parties receiving the covered work authorizing them to use, propagate, modify or convey a specific copy of the covered work, then the patent license you grant is automatically extended to all recipients of the covered work and works based on it.

A patent license is "discriminatory" if it does not include within the scope of its coverage, prohibits the exercise of, or is conditioned on the non-exercise of one or more of the rights that are specifically granted under this License. You may not convey a covered work if you are a party to an arrangement with a third party that is in the business of distributing software, under which you make payment to the third party based on the extent of your activity of conveying the work, and under which the third party grants, to any of the parties who would receive the covered work from you, a discriminatory patent license (a) in connection with copies of the covered work conveyed by you (or copies made from those copies), or (b) primarily for and in connection with specific products or compilations that contain the covered work, unless you entered into that arrangement, or that patent license was granted, prior to 28 March 2007.

Nothing in this License shall be construed as excluding or limiting any implied license or other defenses to infringement that may otherwise be available to you under applicable patent law.

#### **12. No Surrender of Others' Freedom.**

If conditions are imposed on you (whether by court order, agreement or otherwise) that contradict the conditions of this License, they do not excuse you from the conditions of this License. If you cannot convey a covered work so as to satisfy simultaneously your obligations under this License and any other pertinent obligations, then as a consequence you may not convey it at all. For example, if you agree to terms that obligate you to collect a royalty for further conveying from those to whom you convey the Program, the only way you could satisfy both those terms and this License would be to refrain entirely from conveying the Program.

#### **13. Use with the GNU Affero General Public License.**

Notwithstanding any other provision of this License, you have permission to link or combine any covered work with a work licensed under version 3 of the GNU Affero General Public License into a single combined work, and to convey the resulting work. The terms of this License will continue to apply to the part which is the covered work, but the special requirements of the GNU Affero General Public License, section 13, concerning interaction through a network will apply to the combination as such.

#### **14. Revised Versions of this License.**

The Free Software Foundation may publish revised and/or new versions of the GNU General Public License from time to time. Such new versions will be similar in spirit to the present version, but may differ in detail to address new problems or concerns.

Each version is given a distinguishing version number. If the Program specifies that a certain numbered version of the GNU General Public License "or any later version" applies to it, you have the option of following the terms and conditions either of that numbered version or of any later version published by the Free Software Foundation. If the Program does not specify a version number of the GNU General Public License, you may choose any version ever published by the Free Software Foundation.

If the Program specifies that a proxy can decide which future versions of the GNU General Public License can be used, that proxy's public statement of acceptance of a version permanently authorizes you to choose that version for the Program.

Later license versions may give you additional or different permissions. However, no additional obligations are imposed on any author or copyright holder as a result of your choosing to follow a later version.

#### **15. Disclaimer of Warranty.**

THERE IS NO WARRANTY FOR THE PROGRAM, TO THE EXTENT PERMITTED BY APPLICABLE LAW. EXCEPT WHEN OTHERWISE STATED IN WRITING THE COPYRIGHT HOLDERS AND/OR OTHER PARTIES PROVIDE THE PROGRAM "AS IS" WITHOUT WARRANTY OF ANY KIND, EITHER EXPRESSED OR IMPLIED, INCLUDING, BUT NOT LIMITED TO, THE IMPLIED WARRANTIES OF MERCHANTABILITY AND FITNESS FOR A PARTICULAR PURPOSE. THE ENTIRE RISK AS TO THE QUALITY AND PERFORMANCE OF THE PROGRAM IS WITH YOU. SHOULD THE PROGRAM PROVE DEFECTIVE, YOU ASSUME THE COST OF ALL NECESSARY SERVICING, REPAIR OR CORRECTION.

#### **16. Limitation of Liability.**

IN NO EVENT UNLESS REQUIRED BY APPLICABLE LAW OR AGREED TO IN WRITING WILL ANY COPYRIGHT HOLDER, OR ANY OTHER PARTY WHO MODIFIES AND/OR CONVEYS THE PROGRAM AS PERMITTED ABOVE, BE LIABLE TO YOU FOR DAMAGES, INCLUDING ANY GENERAL, SPECIAL, INCIDENTAL OR CONSEQUENTIAL DAMAGES ARISING OUT OF THE USE OR INABILITY TO USE THE PROGRAM (INCLUDING BUT NOT LIMITED TO LOSS OF DATA OR DATA BEING RENDERED INACCURATE OR LOSSES SUSTAINED BY YOU OR THIRD PARTIES OR A FAILURE OF THE PROGRAM TO OPERATE WITH ANY OTHER PROGRAMS), EVEN IF SUCH HOLDER OR OTHER PARTY HAS BEEN ADVISED OF THE POSSIBILITY OF SUCH DAMAGES.

#### **17. Interpretation of Sections 15 and 16.**

If the disclaimer of warranty and limitation of liability provided above cannot be given local legal effect according to their terms, reviewing courts shall apply local law that most closely approximates an absolute waiver of all civil liability in connection with the Program, unless a warranty or assumption of liability accompanies a copy of the Program in return for a fee.

# LGPL

GNU LESSER GENERAL PUBLIC LICENSE  
Version 3, 29 June 2007  
Copyright (C) 2007 Free Software Foundation, Inc. <<http://fsf.org/>>

Everyone is permitted to copy and distribute verbatim copies of this license document, but changing it is not allowed.

This version of the GNU Lesser General Public License incorporates the terms and conditions of version 3 of the GNU General Public License, supplemented by the additional permissions listed below.

## 0. Additional Definitions.

As used herein, "this License" refers to version 3 of the GNU Lesser General Public License, and the "GNU GPL" refers to version 3 of the GNU General Public License.

"The Library" refers to a covered work governed by this License, other than an Application or a Combined Work as defined below.

An "Application" is any work that makes use of an interface provided by the Library, but which is not otherwise based on the Library. Defining a subclass of a class defined by the Library is deemed a mode of using an interface provided by the Library.

A "Combined Work" is a work produced by combining or linking an Application with the Library. The particular version of the Library with which the Combined Work was made is also called the "Linked Version".

The "Minimal Corresponding Source" for a Combined Work means the Corresponding Source for the Combined Work, excluding any source code for portions of the Combined Work that, considered in isolation, are based on the Application, and not on the Linked Version.

The "Corresponding Application Code" for a Combined Work means the object code and/or source code for the Application, including any data and utility programs needed for reproducing the Combined Work from the Application, but excluding the System Libraries of the Combined Work.

## 1. Exception to Section 3 of the GNU GPL.

You may convey a covered work under sections 3 and 4 of this License without being bound by section 3 of the GNU GPL.

## 2. Conveying Modified Versions.

If you modify a copy of the Library, and, in your modifications, a facility refers to a function or data to be supplied by an Application that uses the facility (other than as an argument passed when the facility is invoked), then you may convey a copy of the modified version:

- a. under this License, provided that you make a good faith effort to ensure that, in the event an Application does not supply the function or data, the facility still operates, and performs whatever part of its purpose remains meaningful, or
- b. under the GNU GPL, with none of the additional permissions of this License applicable to that copy.

## 3. Object Code Incorporating Material from Library Header Files.

The object code form of an Application may incorporate material from a header file that is part of the Library. You may convey such object code under terms of your choice, provided that, if the incorporated material is not limited to numerical parameters, data structure layouts and accessors, or small macros, inline functions and templates (ten or fewer lines in length), you do both of the following:

- a. Give prominent notice with each copy of the object code that the Library is used in it and that the Library and its use are covered by this License.
- b. Accompany the object code with a copy of the GNU GPL and this license document.

## 4. Combined Works.

You may convey a Combined Work under terms of your choice that, taken together, effectively do not restrict modification of the portions of the Library contained in the Combined Work and reverse engineering for debugging such modifications, if you also do each of the following:

- a. Give prominent notice with each copy of the Combined Work that the Library is used in it and that the Library and its use are covered by this License.
- b. Accompany the Combined Work with a copy of the GNU GPL and this license document.
- c. For a Combined Work that displays copyright notices during execution, include the copyright notice for the Library among these notices, as well as a reference directing the user to the copies of the GNU GPL and this license document.
- d. Do one of the following:
  - 1) Convey the Minimal Corresponding Source under the terms of this License, and the Corresponding Application Code in a form suitable for, and under terms that permit, the user to recombine or relink the Application with a modified version of the Linked Version to produce a modified Combined Work, in the manner specified by section 6 of the GNU GPL for conveying Corresponding Source.
  - 2) Use a suitable shared library mechanism for linking with the Library. A suitable mechanism is one that (a) uses at run time a copy of the Library already present on the user's computer system, and (b) will operate properly with a modified version of the Library that is interface-compatible with the Linked Version.
- e. Provide Installation Information, but only if you would otherwise be required to provide such information under section 6 of the GNU GPL, and only to the extent that such information is necessary to install and execute a modified version of the Combined Work produced by recombining or relinking the Application with a modified version of the Linked Version. (If you use option 4d0, the Installation Information must accompany the Minimal Corresponding Source and Corresponding Application Code. If you use option 4d1, you must provide the Installation Information in the manner specified by section 6 of the GNU GPL for conveying Corresponding Source.)

## 5. Combined Libraries.

You may place library facilities that are a work based on the Library side by side in a single library together with other library facilities that are not Applications and are not covered by this License, and convey such a combined library under terms of your choice, if you do both of the following:

- a. Accompany the combined library with a copy of the same work based on the Library, uncombined with any other library facilities, conveyed under the terms of this License.
- b. Give prominent notice with the combined library that part of it is a work based on the Library, and explaining where to find the accompanying uncombined form of the same work.

#### 6. Revised Versions of the GNU Lesser General Public License.

The Free Software Foundation may publish revised and/or new versions of the GNU Lesser General Public License from time to time. Such new versions will be similar in spirit to the present version, but may differ in detail to address new problems or concerns.

Each version is given a distinguishing version number. If the Library as you received it specifies that a certain numbered version of the GNU Lesser General Public License "or any later version" applies to it, you have the option of following the terms and conditions either of that published version or of any later version published by the Free Software Foundation. If the Library as you received it does not specify a version number of the GNU Lesser General Public License, you may choose any version of the GNU Lesser General Public License ever published by the Free Software Foundation.

If the Library as you received it specifies that a proxy can decide whether future versions of the GNU Lesser General Public License shall apply, that proxy's public statement of acceptance of any version is permanent authorization for you to choose that version for the Library.

## MIT

Copyright 1987, 1988 by MIT Student Information Processing Board.

Permission to use, copy, modify, and distribute this software and its documentation for any purpose is hereby granted, provided that the names of M.I.T. and the M.I.T. S.I.P.B. not be used in advertising or publicity pertaining to distribution of the software without specific, written prior permission. M.I.T. and the M.I.T. S.I.P.B. make no representations about the suitability of this software for any purpose. It is provided "as is" without express or implied warranty.

## zlib

Copyright (C) 1995-1998 Jean-loup Gailly and Mark Adler

This software is provided 'as-is', without any express or implied warranty. In no event will the authors be held liable for any damages arising from the use of this software.

Permission is granted to anyone to use this software for any purpose, including commercial applications, and to alter it and redistribute it freely, subject to the following restrictions:

1. The origin of this software must not be misrepresented; you must not claim that you wrote the original software. If you use this software in a product, an acknowledgment in the product documentation would be appreciated but is not required.
2. Altered source versions must be plainly marked as such, and must not be misrepresented as being the original software.
3. This notice may not be removed or altered from any source distribution. Jean-loup Gailly Mark Adler jloup@gzip.org madler@alumni.caltech.edu

The data format used by the zlib library is described by RFCs (Request for Comments) 1950 to 1952 in the files ftp://ds.internic.net/rfc/rfc1950.txt (zlib format), rfc1951.txt (deflate format) and rfc1952.txt (gzip format).



# Glossary

The following terms are used throughout this guide:

**Active image** — the portion of the video picture area (production aperture) that is being utilized for output content. Active image excludes letterbox bars and pillar-box bars.

**Auto Select Key** — a key in which two video signals are required to insert the key. The Key Alpha is used to cut the hole in the video, and the Key Video is used to fill that hole.

**Card** — openGear terminal devices within openGear frames, including all components and switches.

**DashBoard** — the DashBoard Control System.

**DTVCC captions** — CEA-708 captions.

**DVE** — Digital Video Effects.

**Frame** — the openGear frame that houses the MC1-UHD unless otherwise noted.

**HTTP** — Direct Hypertext Transfer Protocol.

**LTC** — Linear Timecode.

**MIB** — management information base.

**Network Controller Card** — refers to the MFC-OG3-N and the MFC-OGX-N and any available options.

**NTSC captions** — the CEA-608-D: Line 21 Data Services captions.

**openGear frame** — refers to the OG3-FR series and OGX-FR series frames unless otherwise noted.

**PAL** — PAL-B and PAL-G unless otherwise noted.

**Production aperture** — the image lattice that represents the maximum possible image extent in a given standard (e.g. the full size of all active pixels and active lines). For example, the 1080i production aperture would be 1920x1080.

**Self Key** — a key in which the luminance, or brightness, values of the key source is used as the alpha for the key.

**System** — the mix of interconnected production and terminal equipment in your environment.

**TCP** — Transmission Control Protocol.

**TTL** — Time To Live.

**UDP** — User Datagram Protocol.

**User** — the person who uses the MC1-UHD.

**VGPI** — Virtual GPI feature of the Miranda™ Presmaster Automation and RossTalk protocols.

