



GATOR-TOOLBOX User Guide

Thank You for Choosing Ross

You've made a great choice. We expect you will be very happy with your purchase of Ross Technology.

Our mission is to:

1. Provide a Superior Customer Experience
 - offer the best product quality and support
2. Make Cool Practical Technology
 - develop great products that customers love

Ross has become well known for the Ross Video Code of Ethics. It guides our interactions and empowers our employees. I hope you enjoy reading it below.

If anything at all with your Ross experience does not live up to your expectations be sure to reach out to us at solutions@rossvideo.com.



David Ross
CEO, Ross Video
dross@rossvideo.com

Ross Video Code of Ethics

Any company is the sum total of the people that make things happen. At Ross, our employees are a special group. Our employees truly care about doing a great job and delivering a high quality customer experience every day. This code of ethics hangs on the wall of all Ross Video locations to guide our behavior:

1. We will always act in our customers' best interest.
2. We will do our best to understand our customers' requirements.
3. We will not ship crap.
4. We will be great to work with.
5. We will do something extra for our customers, as an apology, when something big goes wrong and it's our fault.
6. We will keep our promises.
7. We will treat the competition with respect.
8. We will cooperate with and help other friendly companies.
9. We will go above and beyond in times of crisis. *If there's no one to authorize the required action in times of company or customer crisis - do what you know in your heart is right. (You may rent helicopters if necessary.)*

GATOR-TOOLBOX · User Guide

- Ross Part Number: **8922DR-204-06**
- Revision: 4
- Release Date: April 17, 2025.
- Software Version: **4.1**

The information contained in this Guide is subject to change without notice or obligation.

Copyright

©2025 Ross Video Limited, Ross®, and any related marks are trademarks or registered trademarks of Ross Video Limited. All other trademarks are the property of their respective companies. PATENTS ISSUED and PENDING. All rights reserved. No part of this publication may be reproduced, stored in a retrieval system, or transmitted in any form or by any means, mechanical, photocopying, recording or otherwise, without the prior written permission of Ross Video. While every precaution has been taken in the preparation of this document, Ross Video assumes no responsibility for errors or omissions. Neither is any liability assumed for damages resulting from the use of the information contained herein.

3D-LUT RGB Cube Files from BBC

These 3D-LUT files are designed and copyrighted by the BBC and are available under license.

3D-LUT RGB Cube Files from NBCU

These 3D-LUT files are designed and copyrighted by the NBC Universal and are publicly available free of use.

Patents

Patent numbers US 7,034,886; US 7,508,455; US 7,602,446; US 7,802,802 B2; US 7,834,886; US 7,914,332; US 8,307,284; US 8,407,374 B2; US 8,499,019 B2; US 8,519,949 B2; US 8,743,292 B2; GB 2,419,119 B; GB 2,447,380 B; and other patents pending.

Notices

The material in this manual is furnished for informational use only. It is subject to change without notice and should not be construed as commitment by Ross Video Limited. Ross Video Limited assumes no responsibility or liability for errors or inaccuracies that may appear in this manual.

Note: As required by the GNU General Public License, and the Lesser GNU Public License (LGPL), source code can be obtained from Ross Video for at least 3 years. Contact Ross Video Technical Support for more information. If you have any questions or comments regarding this License Agreement, please contact:

Ross Video Limited
8 John Street
P.O. Box 220
Iroquois, ON
Canada K0E 1K0
techsupport@rossvideo.com

Trademarks

- Dolby® is a registered trademark of Dolby Laboratories.
-

Safety Notices

Refer to the “**Important Regulatory and Safety Notices**” document that accompanied your product.

Statement of Compliance

This product has been determined to be compliant with the applicable standards, regulations, and directives for the countries where the product is marketed.

Compliance documentation, such as certification or Declaration of Compliance for the product is available upon request by contacting techsupport@rossvideo.com. Please include the product; model number identifiers and serial number and country that compliance information is needed in request.

EMC Notices

US FCC Part 15

This equipment has been tested and found to comply with the limits for a class A Digital device, pursuant to part 15 of the FCC Rules.

These limits are designed to provide reasonable protection against harmful interference when the equipment is operated in a Commercial environment. This equipment generates, uses, and can radiate radio frequency energy and, if not installed and used in accordance with the instruction manual, may cause harmful interference to radio communications. Operation of this equipment in a residential area is likely to cause harmful interference in which case the user will be required to correct the interference at his own expense.



Notice — *Changes or modifications to this equipment not expressly approved by Ross Video Ltd. could void the user's authority to operate this equipment.*

Canada

This Class “A” digital apparatus complies with Canadian ICES-003 and part 15 of the FCC Rules.

Cet appareil numérique de la classe “A” est conforme a la norme NMB-003 du Canada.

European Union

This equipment is in compliance with the essential requirements and other relevant provisions established under regulation (EC) No 765/2008 and Decision No 768/2008/EC referred to as the “New Legislative Framework”.



Warning — *This equipment is compliant with Class A of CISPR 32. In a residential environment this equipment may cause radio interference.*

Australia/New Zealand

This equipment is in compliance with the provisions established under the Radiocommunications Act 1992 and Radiocommunications Labeling (Electromagnetic Compatibility) Notice 2008.

Korea

This equipment is in compliance with the provisions established under the Radio Waves Act.

Class A equipment (Broadcasting and communications service for business use)

This device is a business-use (Class A) EMC-compliant device. The seller and user are advised to be aware of this fact. This device is intended for use in areas outside home.

Type of Equipment	User's Guide
A급 기기 (업무용 방송통신기자재) Class A Equipment (Industrial Broadcasting & Communication Equipment)	이 기기는 업무용(A급) 전자파적합기기로서 판매자 또는 사용자는 이 점을 주의하시기 바라며, 가정외의 지역에서 사용하는 것을 목적으로 합니다. This equipment is Industrial (Class A) electromagnetic wave suitability equipment and seller or user should take notice of it, and this equipment is to be used in the places except for home.

International

This equipment has been tested under the requirements of CISPR 22:2008 or CISPR 32:2015 and found to comply with the limits for a Class A Digital device.



Notice — *This is a Class A product. In domestic environments, this product may cause radio interference, in which case the user may have to take adequate measures.*

Maintenance/User Serviceable Parts

Routine maintenance to this openGear product is not required. This product contains no user serviceable parts. If the module does not appear to be working properly, please contact Technical Support using the numbers listed under the “**Contact Us**” section of this manual. All openGear products are covered by a generous 5-year warranty and will be repaired without charge for materials or labor within this period. See the “**Warranty and Repair Policy**” section in this manual for details.

Environmental Information

The equipment may contain hazardous substances that could impact health and the environment. To avoid the potential release of those substances into the environment and to diminish the need for the extraction of natural resources, Ross Video encourages you to use the appropriate take-back systems. These systems will reuse or recycle most of the materials from your end-of-life equipment in an environmentally friendly and health conscious manner.

The crossed-out wheeled bin symbol invites you to use these systems.



If you need more information on the collection, reuse, and recycling systems, please contact your local or regional waste administration. You can also contact Ross Video for more information on the environmental performances of our products.

Security and Privacy

If you would like more information on how Ross Video security and privacy practices have been applied to the GATOR-TOOLBOX, what you should know about maintaining security of this product, and how we can partner with you to ensure security throughout this product's life-cycle, contact techsupport@rossvideo.com.

Ross Video has implemented reasonable administrative, technical, and physical safeguards to help protect against security incidents and privacy breaches involving a Ross Video product provided those products are used in accordance with Ross Video instructions for use. However, as systems and threats evolve, no system can be protected against all vulnerabilities and we consider our customers the most important partner in maintaining security and privacy safeguards. If you have any concerns, we ask that you bring them to our attention, and we will investigate. Where appropriate, we will address the issue with product changes, technical bulletins and/or responsible disclosures to customers and regulators. Ross Video continuously strives to improve security and privacy throughout the product life-cycle using practices such as:

- Privacy and Security by Design
- Product and Supplier Risk Assessment
- Vulnerability and Patch Management
- Secure Coding Practices and Analysis
- Vulnerability Scanning
- Access Controls appropriate to Customer Data
- Incident Response
- Clear paths for two-way communication between customers and Ross Video

If you would like to report a potential product related privacy or security issue (incident, breach, or vulnerability), contact techsupport@rossvideo.com.

Company Address



Ross Video Limited

8 John Street
Iroquois, Ontario
Canada, K0E 1K0

Ross Video Incorporated

P.O. Box 880
Ogdensburg, New York
USA 13669-0880

General Business Office: (+1) 613 • 652 • 4886

Fax: (+1) 613 • 652 • 4425

Technical Support: (+1) 613 • 652 • 4886

After Hours Emergency: (+1) 613 • 349 • 0006

E-mail (Technical Support): techsupport@rossvideo.com

E-mail (General Information): solutions@rossvideo.com

Website: <http://www.rossvideo.com>

Contents

Introduction	13
Related Publications	14
Documentation Conventions	14
Interface Elements	14
User Entered Text	14
Referenced Guides	14
Menu Sequences	14
Important Instructions	14
Contacting Technical Support	15
Before You Begin	17
Features	17
Supported Formats for Conversion	18
GATOR-2, GATOR-4A, and GATOR-4B Block Diagram	19
GATOR-2F Block Diagram	20
SNMP Monitoring and Control	20
Using DataSafe	20
Integration Example	21
System Integration Example	21
Basic Setup	21
Network Settings	21
Configure the GATOR-TOOLBOX	22
Solution for Audio Processing	22
Overview	22
Hardware Overview	23
Overview	23
Main PCB Overview	23
Reset Button	23
Reference Termination Jumper (JP3)	23
Micro SD Card Slot	24
Supported Rear Modules	24
R3A-GATOR Rear Module	24
R3B-GATOR Rear Module	25
R4-GATOR Rear Module	25
R4F-GATOR Rear Module	26
Physical Installation	27
Before You Begin	27
Working with Fiber Optic Connectors	27
Removing the Blank Plates from the Rear Panel	28
Installing the Rear Module into the openGear Frame	28
Installing the GATOR-TOOLBOX Card into an openGear Frame	29
Cabling	31
Cabling the Ethernet Port on the openGear Frame	31
Before You Begin	31
Cabling for the Reference Input for an GATOR-TOOLBOX	31
Video Signal Cabling	32

SDI Inputs	33
SDI Outputs	34
Bi-directional Cabling	35
Audio Cabling	35
R3A-GATOR Cabling	35
R3B-GATOR Cabling	36
GPIO Cabling	37
R3A-GATOR Cabling	37
R3B-GATOR Cabling	37
R4-GATOR Cabling	38
R4F-GATOR Cabling	38
Getting Started	39
Before You Begin	39
Launching DashBoard	39
Configuring the Initial Network Settings	39
Accessing the GATOR-TOOLBOX Interfaces in DashBoard	40
Configuring the Network Settings	43
Before You Begin	43
Changing the Network Settings of the GATOR-TOOLBOX	43
Dual Channel Mode Setup	45
Overview	45
Before You Begin	46
Specifying the Channel Mode	47
Displaying the Dual Channel Interfaces	47
Installing License Keys for a Toolbox Channel	48
Mapping the Audio Channels for Dual Channel Mode	49
Using Dual Channel Mode and the R4F-GATOR Rear Module	51
Loss of Input Failover Mode	52
GPIOs and Dual Channel Mode	53
Licensed Features	55
License Keys Overview	55
Installing a License Key	55
Disabling a License Key	56
Reference Setup	57
Frame Rate Compatibility	57
Specifying a Global Reference Source	59
Monitoring the Reference Signal via DashBoard	59
Basic Video Configuration	61
Mapping the GATOR-TOOLBOX I/O	61
Bi-directional Mapping	61
Video Input Setup	62
Specifying the Primary and Backup Video Sources	62
Loss of Input Failover Mode	63
Verifying the Active SDI Input Signal	64
Video Output Setup	65
Specifying the Output Format	65
Specifying the Output Video Source	65
Adjusting the Output Timing	66

Configuring 2SI Quad Link	67
Gearbox Overview	67
Timing	67
UHD Transport Overview	67
Two Sample Interleave (2SI)	67
Input Gearbox	68
Output Gearbox	68
Configuring the GATOR-TOOLBOX for Multiplexing 2SI Quad Link	68
Configuring the GATOR-TOOLBOX for De-multiplexing a 12Gbps Signal	68
Configuring the GATOR-TOOLBOX for 2SI Quad Link Inputs and Outputs	69
Configuring SQD Quad Link	71
What is Square Division Quad Split (SQD)?	71
How does SQD differ from 2 Sample Interleave (2SI)?	71
Configuring the GATOR-TOOLBOX for Multiplexing Quad Link SQD	71
Configuring the GATOR-TOOLBOX for De-multiplexing a 12Gbps Signal	72
Configuring the GPI/Tallies	73
GPI Communication Setup	73
Configuring a Port as a GPI	73
Tally Communication Setup	74
Format Converter Setup	75
Overview	75
Format Converter Setup	75
SDR/HDR Conversion	77
Overview	77
Built-in SDR/HDR Conversion	77
SDR/HDR Conversion with 3D-LUT RGB Cube Files	78
Accessing the SDR/HDR Conversion Settings	78
Bypassing the Video Correction Settings	78
Dynamic Range and Colorimetry/Transfer Characteristics Setup	79
Proc Amps Setup	80
Black Offset	80
Gain	80
Saturation	80
Hue Rotation	80
Built-In SDR/HDR Conversion Setup	80
Selecting a Tone Mapping Conversion Option	81
Selecting a Conversion Mapping Option	81
Direct Mapping, 1-to-1 No Scaling	81
Direct Mapping, BT.2408 Scaling	81
SDR/HDR Conversion with 3D-LUT RGB Cube Files	81
Loading a 3D-LUT RGB Cube File	82
Specifying the 3D-LUT RGB Cube File Type	82
Pre-Loaded RGB Cube Files Library	83
3D-LUT RGB Cube Files from BBC	83
3D-LUT RGB Cube Files from NBCU	84
Loading Custom RGB Cube Files	84
Loading a 3D-LUT Cube File to the GATOR-TOOLBOX	85
SDI Video Output Clipping Setup	86
RGB Color Correction	86
Overview	86
Monitoring the Color Conversion	87

Bypass Alarm	87
Input Mismatch Alarm	88
Cube File Alarm	88
Ancillary Data	89
Overview	89
HANC and VANC Status	89
CEA-708/CEA-608 Closed Captioning	89
Captioning Priority	90
Other Data Types	90
Specific ANC Processing	91
ANC Processing Overview	91
SMPTE ST 352 Packet Insertion	92
Audio Configuration	93
Configuring the AES Pairs	93
Selecting an AES Configuration	93
Configuring the AES Outputs	93
Processing the Embedded Audio Input	94
Mapping the Embedded Audio Channels	94
Configuring the Audio Outputs for Dolby® E Metadata	95
Using Presets	99
Overview	99
Storing a Preset	99
Recalling a Preset	100
Upgrading the Software	101
DashBoard Interface Overview	103
Global Interface	103
Signal Tab	103
Product Tab	104
Hardware Tab	105
Licensing State Tab	106
Setup Tab	108
Network Tab	110
Global Alarm Enables Tab	111
Security Tab	113
Preset Tab	113
GPI/Tally Tab	113
Configure License Tab	115
Logging Tab	116
Gator Toolbox Interfaces	116
Gator Toolbox Status Tab	116
Input Status Tab	118
Config Tab	122
Video Correction Tabs	123
Audio Tab	128
ANC Tab	131
Format Converter Tab	132
Technical Specifications	133
Supported Video Formats	133

SDI Inputs Specifications	134
SDI Outputs Specifications	134
AES Specifications	135
GATOR-4A	135
GATOR-4B	136
GPIO	137
Environment	137
Power	137
Supported SFP Modules	139
SFP-FIBER-12G	139
Features	139
Simplified Block Diagram	139
Technical Specifications	139
Physical Channel Position	140
Service Information	141
Reloading the Software on the Card	141
Warranty and Repair Policy	141
Software Licenses	143
BSD	143
Dual GPL	143
GPL	143
LGPL	147
MIT	148
zlib	148
Glossary	149

Introduction

This guide covers the installation, configuration, and use of the GATOR-TOOLBOX Multi-format Frame Synchronizer. The following chapters are included:

- **“Introduction”** summarizes the guide and provides important terms, and conventions.
- **“Before You Begin”** provides general information to keep in mind before installing and configuring your card.
- **“Integration Example”** provides an overview of the most common settings required to add your card to an existing setup.
- **“Hardware Overview”** provides a basic introduction to the GATOR-TOOLBOX hardware features including the supported rear modules.
- **“Physical Installation”** provides instructions for the physical installation of the card and its rear module into an openGear frame.
- **“Cabling”** provides an overview of connecting input and output devices to the rear module of the GATOR-TOOLBOX.
- **“Getting Started”** outlines how to display the card interfaces in DashBoard.
- **“Configuring the Network Settings”** outlines how to update the network settings assigned to the GATOR-TOOLBOX.
- **“Dual Channel Mode Setup”** summarizes the steps to configure the GATOR-TOOLBOX in dual channel mode.
- **“Licensed Features”** outlines the available software licensed features, and how to install a software key for a licensed feature.
- **“Reference Setup”** outlines the frame rate compatibility, and how to configure and monitor the reference signal the GATOR-TOOLBOX will use for timing purposes.
- **“Basic Video Configuration”** outlines how to specify the output format and video source, adjust the timing, and summarizes what the card will do during a loss of signal.
- **“Configuring 2SI Quad Link”** provides information for configuring the card to carry UHD video content.
- **“Configuring SQD Quad Link”** provides information on the Square Division Quad feature of the GATOR-TOOLBOX.
- **“Configuring the GPI/Tallies”** outlines how to configure each GPI/Tally independently on the GATOR-TOOLBOX.
- **“Format Converter Setup”** provides instructions for configuring the Format Converter (FRC) licensed feature using the menus in DashBoard.
- **“SDR/HDR Conversion”** summarizes how to use the Proc Amps and RGB Color Correctors of the card.
- **“Ancillary Data”** provides an overview of ANC processing for the GATOR-TOOLBOX.
- **“Audio Configuration”** provides instructions for configuring the audio features using the menus in DashBoard.
- **“Using Presets”** outlines how to save and recall preset configurations to your GATOR-TOOLBOX.
- **“Upgrading the Software”** outlines how to upgrade the GATOR-TOOLBOX via DashBoard.
- **“DashBoard Interface Overview”** summarizes the menus and parameters of the GATOR-TOOLBOX tabs in DashBoard.
- **“Technical Specifications”** provides the specifications for the GATOR-TOOLBOX.
- **“Supported SFP Modules”** provides the specifications for each supported SFP module.

- “**Service Information**” provides information on the warranty and repair policy for your GATOR-TOOLBOX.
- “**Software Licenses**” provides third-party software license information for your GATOR-TOOLBOX.
- “**Glossary**” provides a list of terms used throughout this guide.

Related Publications

It is recommended to consult the following Ross documentation before installing and configuring your GATOR-TOOLBOX:

- ***DashBoard User Guide***, Ross Part Number: 8351DR-004
- ***MFC-OG3-N and MFC-8322-S User Guide***, Ross Part Number: 8322DR-004
- ***OGX-FR Series Quick Start Guide***, Ross Part Number: 8322DR-202
- ***OGX-FR Series User Guide***, Ross Part Number: 8322DR-204

Documentation Conventions

Special text formats are used in this guide to identify parts of the user interface, text that a user must enter, or a sequence of menus and sub-menus that must be followed to reach a particular command.

Interface Elements

Bold text is used to identify a user interface element such as a dialog box, menu item, or button. For example:

In the **Network** tab, click **Apply**.

User Entered Text

Courier text is used to identify text that a user must enter. For example:

In the **Language** box, enter `English`.

Referenced Guides

Text set in bold and italic represent the titles of referenced guides, manuals, or documents. For example:

For more information, refer to the ***DashBoard User Manual***.

Menu Sequences

Menu arrows are used in procedures to identify a sequence of menu items that you must follow. For example, if a step reads “**File > Save As**,” you would click the **File** menu and then click **Save As**.

Important Instructions

Star icons are used to identify important instructions or features. For example:

- ★ Contact your IT department before connecting to your facility network to ensure that there are no conflicts. They will provide you with an appropriate value for the IP Address, Subnet Mask, and Gateway for your device.

Contacting Technical Support

At Ross Video, we take pride in the quality of our products, but if problems occur, help is as close as the nearest telephone.

Our 24-hour Hot Line service ensures you have access to technical expertise around the clock. After-sales service and technical support is provided directly by Ross Video personnel. During business hours (Eastern Time), technical support personnel are available by telephone. After hours and on weekends, a direct emergency technical support phone line is available. If the technical support person who is on call does not answer this line immediately, a voice message can be left and the call will be returned shortly. This team of highly trained staff is available to react to any problem and to do whatever is necessary to ensure customer satisfaction.

- **Technical Support:** (+1) 613-652-4886
- **After Hours Emergency:** (+1) 613-349-0006
- **E-mail:** techsupport@rossvideo.com
- **Website:** <http://www.rossvideo.com>

Before You Begin

If you have questions about the operation of GATOR-TOOLBOX, contact us at the numbers listed in **“Contacting Technical Support”**. Our technical staff is always available for consultation, training, or service.

Features

The GATOR-TOOLBOX includes the following features:

- High quality conversion engine delivering best quality Up/Down/Cross conversion over a wide variety of formats including:
 - › 2160p 23.98/24/25/29.97/30/50/59.94/60
 - › 1080p 23.98/24/25/29.97/30/50/59.94/60
 - › 1080i 50/59.94/60
 - › 720p 50/59.94/60
 - › 576i 50Hz
 - › 480i 59.94Hz
- Advance Motion adaptive de-interlacing with cadence detection
- Provides two processing modes: single channel and dual channel
- Optional high quality motion adaptive linear frame rate conversion
- Optional 3D-LUT for advanced HDR/WCG conversion
- Support for importing industry-standard 3D-LUT 33x33x33 RGB cube files
- HDR support with conversion from and to SDR, PQ, S-LOG3, HLG, and SR Live
- Support for BT.709 and Wide Colorimetry/Transfer BT.2020
- Input RGB Color correction and Proc amps
- Support for Single link HD/3G/UHD SDI, Quad 3G 2SI through flexible gearboxes ¹
- Support for 12G SDI fiber (requires the GATOR-2F rear module)
- Detects the incoming video formats and converts to the assigned output format²
- Built in frame synchronizer times the outputs to a selectable local or frame wide reference
- Supports bi-level, and tri-level sync
- Passes SMPTE 291M formatted vertical ancillary data from input to output
- Support for detecting Dolby® E® metadata with an option for auto alignment
- 16 channels of discrete AES embed / de-embed (GATOR-4A / GATOR-4B only)
- 16 channels embedded audio pass through with SRC with full embedded audio processing and ability to delay relative to video (*Single Channel mode*)
- 16 channels per Toolbox Channel, embedded audio pass through with SRC with full embedded audio processing and ability to delay relative to video (*Dual Channel mode*)
- Reports status and configuration remotely via the DashBoard control system
- Compatible with DataSafe
- Fully compliant with openGear specifications
- 5-year transferable warranty

1. Not available when operating in Dual Channel mode.

2. The output format must be compatible with the reference format. Refer to **“Frame Rate Compatibility”**.

Supported Formats for Conversion

The following table outlines the supported formats for conversion and the required license(s).

Gator Toolbox Supported Format Conversion

OUT \ IN		23.98		24		25		50		29.97		30		59.94		60		
		1080p	2160p	1080p	2160p	1080p	2160p	1080p	2160p	1080p	2160p	1080p	2160p	480i	720p	1080i	1080p	2160p
23.98	1080p	•	U	•	U	•	U	•	U	•	U	•	U	F	F	F	F	UF
	1080pSF	•	U	•	U	•	U	•	U	•	U	•	U	F	F	F	F	UF
	2160p	U	U	U	U	U	U	U	U	U	U	U	U	UF	UF	UF	UF	UF
24	1080p	•	U	•	U	•	U	•	U	•	U	•	U	F	F	F	F	UF
	1080pSF	•	U	•	U	•	U	•	U	•	U	•	U	F	F	F	F	UF
	2160p	U	U	U	U	U	U	U	U	U	U	U	U	UF	UF	UF	UF	UF
25	1080p	F	UF	F	UF	•	U	•	•	•	•	•	•	F	F	F	F	UF
	2160p	UF	UF	UF	UF	U	U	U	U	U	U	U	U	UF	UF	UF	UF	UF
50	576i	•	•	•	•	•	•	•	•	•	•	•	•	•	•	•	•	•
	720p	•	•	•	•	•	•	•	•	•	•	•	•	•	•	•	•	•
	1080i	•	•	•	•	•	•	•	•	•	•	•	•	•	•	•	•	•
	1080p	•	•	•	•	•	•	•	•	•	•	•	•	•	•	•	•	•
	2160p	UF	UF	UF	UF	U	U	U	U	U	U	U	U	UF	UF	UF	UF	UF
29.97	1080p	F	UF	F	UF	F	UF	F	UF	F	UF	F	UF	•	•	•	•	•
	2160p	UF	UF	UF	UF	UF	UF	UF	UF	UF	UF	UF	UF	•	•	•	•	•
30	1080p	F	UF	F	UF	F	UF	F	UF	F	UF	F	UF	•	•	•	•	•
	2160p	UF	UF	UF	UF	UF	UF	UF	UF	UF	UF	UF	UF	•	•	•	•	•
59.94	480i	F	UF	F	UF	F	UF	F	UF	F	UF	F	UF	•	•	•	•	•
	720p	F	UF	F	UF	F	UF	F	UF	F	UF	F	UF	•	•	•	•	•
	1080i	F	UF	F	UF	F	UF	F	UF	F	UF	F	UF	•	•	•	•	•
	1080p	F	UF	F	UF	F	UF	F	UF	F	UF	F	UF	•	•	•	•	•
60	720p	F	UF	F	UF	F	UF	F	UF	F	UF	F	UF	•	•	•	•	•
	1080i	F	UF	F	UF	F	UF	F	UF	F	UF	F	UF	•	•	•	•	•
	1080p	F	UF	F	UF	F	UF	F	UF	F	UF	F	UF	•	•	•	•	•
	2160p	UF	UF	UF	UF	UF	UF	UF	UF	UF	UF	UF	UF	•	•	•	•	•

- Supported
- U Supported - UHD License Required
- F Supported - FRC License Required
- UF Supported - UHD and FRC Licenses Required
- X Unsupported

GATOR-2, GATOR-4A, and GATOR-4B Block Diagram

Figure 1 provides a general overview when using the GATOR-2, GATOR-4A, or GATOR-4B systems.

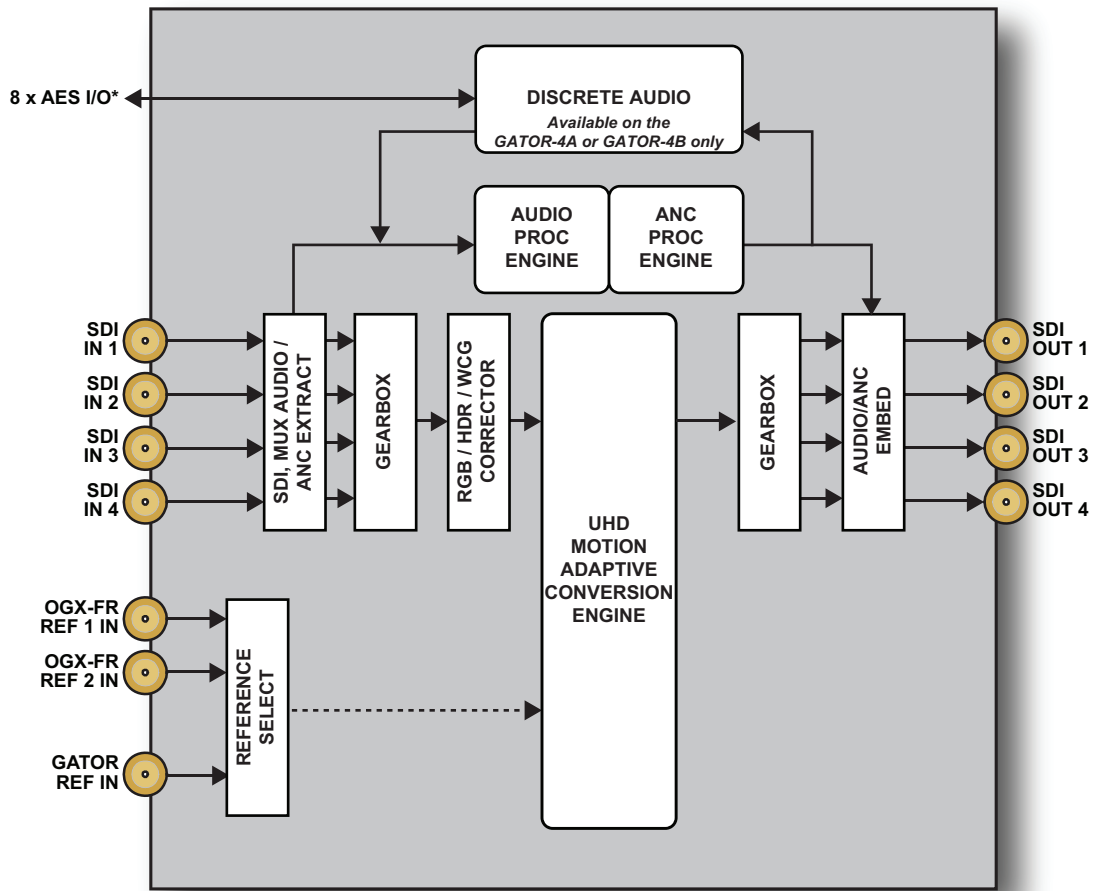

* The type of AES connections (balanced or unbalanced) depends on the rear module installed with the card.

Figure 1 Functional Block Diagram — GATOR-2, GATOR-4A, or GATOR-4B, Single Channel Mode

For More Information on...

- the hardware versions of GATOR-TOOLBOX, refer to “**Hardware Overview**”.

GATOR-2F Block Diagram

Figure 2 provides a general overview when using the GATOR-2F system.

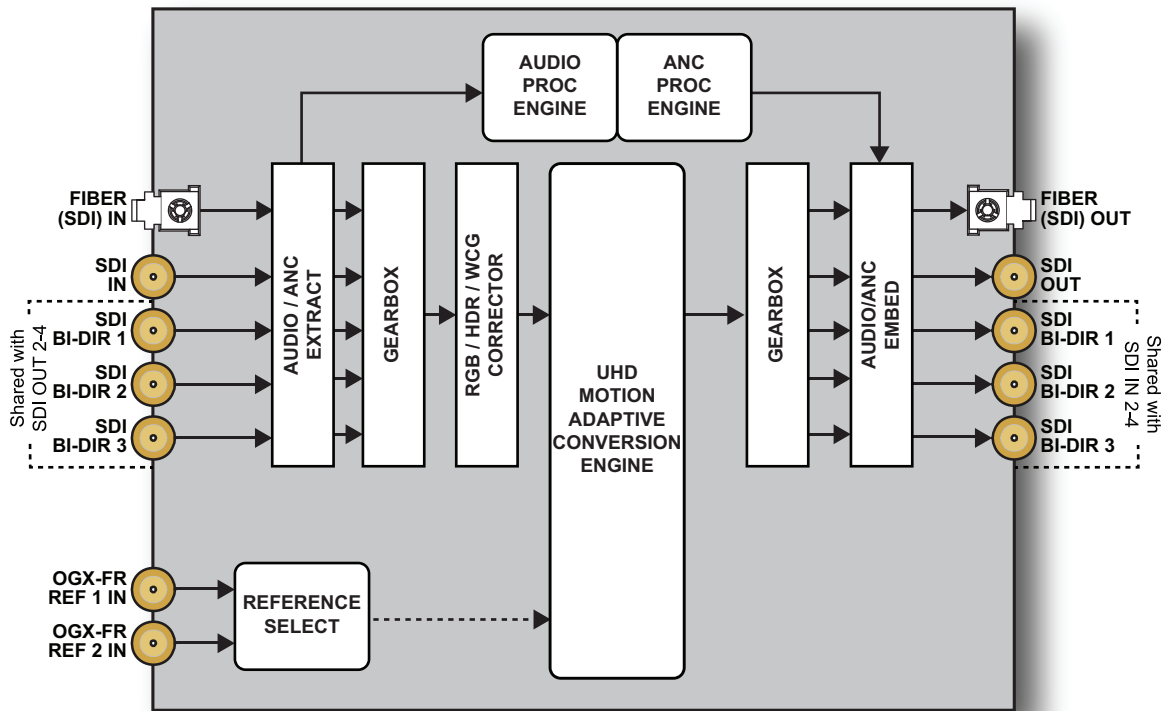

Figure 2 Functional Block Diagram — GATOR-2F, Single Channel Mode

SNMP Monitoring and Control

The Network Controller card in the openGear frame provides optional support for remote monitoring of your frame and the GATOR-TOOLBOX card using Simple Network Management Protocol (SNMP), which is compatible with many third-party monitoring and control tools.

For More Information on...

- enabling SNMP Monitoring and Control for your frame, refer to the **MFC-OG3-N and MFC-8322-S User Guide**.
- SNMP controls for your card, refer to its Management Information Base (MIB) file. Contact Ross Technical Support for this file.

Using DataSafe

DataSafe enables you to load and store card parameters automatically, or you can load from and store to a single file in DashBoard. Ensure that you are loading parameters to the same model of card. The DataSafe feature is available for openGear frames using the MFC-OG3-N or MFC-OGX-N card only. For details on using the DataSafe feature, refer to the **MFC-OG3-N and MFC-8322-S User Guide** and the **DashBoard User Guide**.

- ★ The Ethernet setup settings are not restored/saved using DataSafe.

Integration Example

GATOR-TOOLBOX is an easy to use signal chain problem solver that can be quickly integrated within an existing work flow to perform format, transport, rate and dynamic range conversion. The following example will walk you through the most common settings required to add your card to an existing setup.

System Integration Example

A user is building a flight pack that will drive large UHD monitors with live SDR or HDR content. The setup includes the following:

- The cameras are multi-link UHD or 3G
- Converting multi-link UHD to single-link UHD necessary to fit within the router I/O
- Some sources are asynchronous both UHD and below
- The graphic source output at 60Hz and needs to be converted to HDR



Figure 3 Example of a Work Flow with GATOR-TOOLBOX

Basic Setup

The user needs to physically install the GATOR-TOOLBOX and ensure the following tasks are performed:

1. Install and configure the openGear frame that houses the GATOR-TOOLBOX. Refer to the **OGX-FR Series User Guide** for details.
2. Install the rear module for the GATOR-TOOLBOX. Refer to **“Installing the Rear Module into the openGear Frame”**.
3. Install the GATOR-TOOLBOX into the openGear frame. Refer to **“Installing the GATOR-TOOLBOX Card into an openGear Frame”**.
4. Connect the SDI signals to the GATOR-TOOLBOX rear module. Refer to **“Cabling”**.

Network Settings

Now the user needs to connect the GATOR-TOOLBOX to the network and ensure it can communicate with a computer running the latest DashBoard client software. The DashBoard client software enables you to monitor, configure, and operate your GATOR-TOOLBOX.

The user must perform the following tasks to access and configure the GATOR-TOOLBOX:

1. Verify that a computer running the latest DashBoard client software is installed and available on the same subnet as the GATOR-TOOLBOX. The DashBoard client software and user guide are available from our website.
2. Verify that the openGear frame displays in the Tree View of DashBoard. Refer to the **OGX-FR Series User Guide** for details.
3. Display the GATOR-TOOLBOX in DashBoard as outlined in **“Accessing the GATOR-TOOLBOX Interfaces in DashBoard”**.

Configure the GATOR-TOOLBOX

The GATOR-TOOLBOX is now ready for configuration. To complete the setup, the user must:

1. Select a valid reference source. Refer to **“Specifying a Global Reference Source”**.
2. Specify the transport type that the stream the GATOR-TOOLBOX will ingest. Refer to **“Basic Video Configuration”**.
3. Specify the transport type that the GATOR-TOOLBOX will output. Refer to **“Basic Video Configuration”**.
4. Specify the output format. Refer to **“Basic Video Configuration”**.
5. Specify the output timing requirements. Refer to **“Basic Video Configuration”**.

Solution for Audio Processing

A production setup has a stereo embedded audio source but:

- the video is asynchronous and is delayed by 8 frames due to passing through a virtual set
- the gain on the microphone is set too low and needs to be corrected

Overview

The solution for this user is to:

1. Enable Sample Rate Conversion (SRC) on the GATOR-TOOLBOX. Refer to **“To set up processing of the embedded audio input”**.
2. Increase the audio gain to the required level. Refer to **“To set up processing of the embedded audio input”**.
3. Delay the audio by the required amount. Refer to **“To set up processing of the embedded audio input”**.
4. Map the stereo channel to channels 1,2 and 7,8 respectively. Refer to **“To map a channel”**.

Hardware Overview

This chapter presents information on the GATOR-TOOLBOX hardware components and features.

Overview

The GATOR-TOOLBOX is an openGear modular system composed of two sub-systems.

- a main PCB which connects to a rear module and the openGear frame midplane
- a rear module that provides physical connectors

Table 1 outlines which rear module mates with specific main PCB version and openGear frames.

Table 1 Rear Modules — Supported openGear Frames

Code Displayed in Dashboard	Main PCB Marketing Code	PCB Part Number	Rear Module Marketing Code	Rear Module Part Number	Supported openGear Frame
GATOR-TOOLBOX	GATOR-2	8929AR-251	R4-GATOR	8323AR-325	OGX-FR
GATOR-TOOLBOX	GATOR-2F	8929AR-252	R4F-GATOR	8323AR-327	OGX-FR
GATOR-TOOLBOX-A	GATOR-4A	8929AR-253	R3A-GATOR	8322AR-319C	OG3-FR OGX-FR
GATOR-TOOLBOX-B	GATOR-4B	8929AR-254	R3B-GATOR	8322AR-318D	OG3-FR, OGX-FR



Notice — Installing the GATOR-TOOLBOX in a frame other than the OG3-FR or OGX-FR could damage the card, the rear module, or both. The GATOR-TOOLBOX must be installed in a -CN or -CNS frame. It is not supported on -C frames using the MFC-8322-S controller card.

Main PCB Overview

The main PCB is a typical openGear card. An ejector on one end secures the card to the slot inside the openGear frame, and the other end inserts into a connector on the back of the rear module.

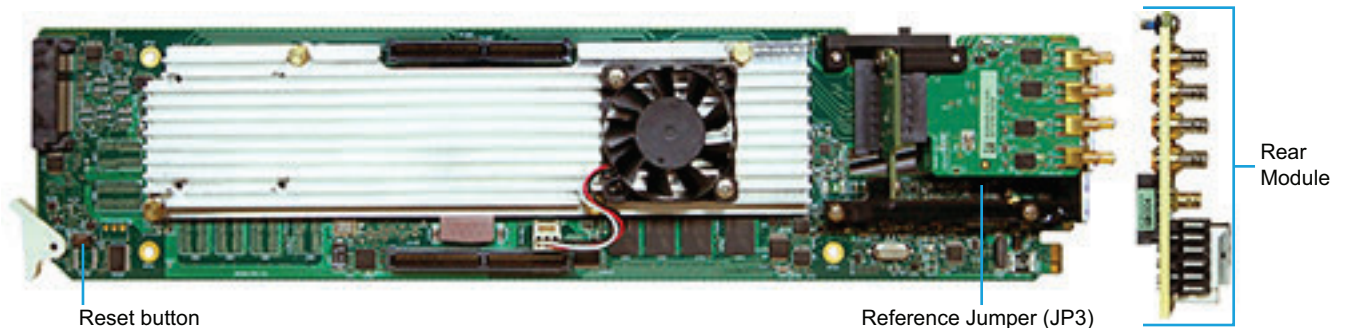

Figure 4 GATOR-TOOLBOX — Base Card Components

Reset Button

Pressing this button resets the microprocessor and re-initializes the card. This is a hard reset of the card. This action should only be before as advised by Ross Video Technical Support.

Reference Termination Jumper (JP3)

JP3 is a 3-position jumper block used to configure the 75ohm termination on the local reference input of the rear module. Refer to **Figure 5** for pin positions.

- **Pin 1** (bottom) + **Pin 2** (center) — This is the default position. The reference is terminated with a 75ohm resistor. This position is used for point-to-point cabling, or on the last card of a daisy chain topology.

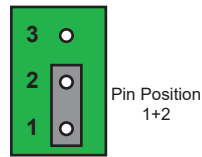

Figure 5 JP3 — Default Position

- **Pin 2** (center) + **Pin 3** (top) — The 75ohm termination is removed and the reference is not terminated. This configuration is used in a daisy chain cabling topology where only the last card is terminated.

Micro SD Card Slot

The Micro SD card slot is located on the backside of the main PCB and just above the ejector.

★ Ensure the Micro SD card is properly seated in its slot before installing the GATOR-TOOLBOX.

Supported Rear Modules

This section provides an overview of the rear module cabling for each GATOR-TOOLBOX system.

R3A-GATOR Rear Module

The R3A-GATOR rear module occupies four slots and accommodates one card. (Figure 6) The following connections are available:

- 4 SDI inputs on HD-BNCs
- 4 SDI outputs on HD-BNCs
- 6 GPIO connections
- 8 AES unbalanced connections on HD-BNCs
- 1 independent reference input signal (bi-level or tri-level sync)

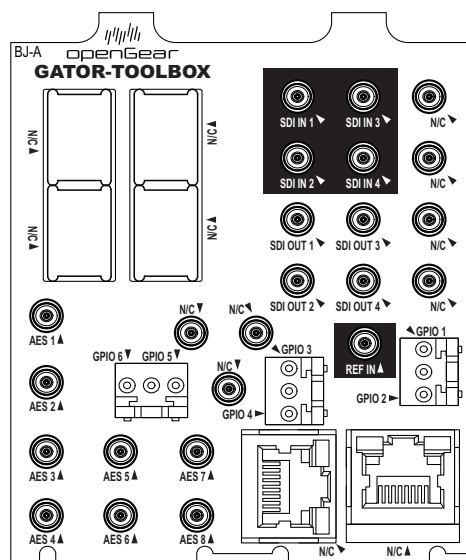

Figure 6 Cabling Designations — R3A-GATOR

R3B-GATOR Rear Module

The R3B-GATOR rear module occupies four slots and accommodates one card. **(Figure 7)** The following connections are available:

- 4 SDI inputs on HD-BNCs
- 4 SDI outputs on HD-BNCs
- 6 GPIO connections
- 8 AES balanced connections on 3-pin connectors
- 1 independent reference input signal (bi-level or tri-level sync)

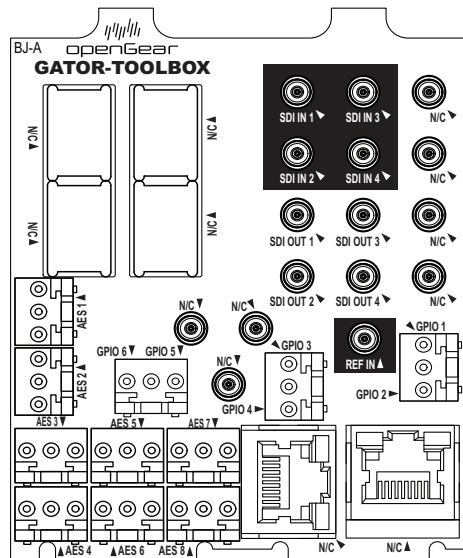

Figure 7 Cabling Designations — R3B-GATOR

R4-GATOR Rear Module



Notice — Installing the R4-GATOR in a frame other than the OGX-FR could damage the card, the rear module, or both.

The R4-GATOR rear module occupies two slots and accommodates one card. **(Figure 8)** The following connections are available:

- 4 SDI inputs on HD-BNCs
- 4 SDI outputs on HD-BNCs
- 4 GPIO connections
- 1 independent reference input signal

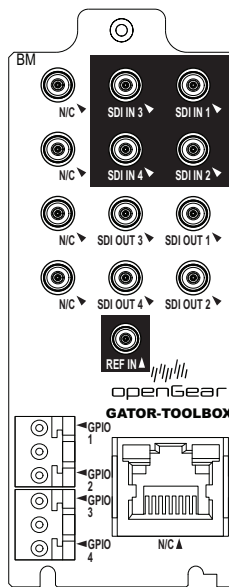

Figure 8 Cabling Designations — R4-GATOR Rear Module

R4F-GATOR Rear Module



Notice — Installing the R4F-GATOR in a frame other than the OGX-FR could damage the card, the rear module, or both.

The R4F-GATOR rear module occupies two slots and accommodates one card. **(Figure 9)** The following connections are available:

- 1 dedicated SDI input on HD-BNC
- 1 dedicated SDI input on fiber optic port
- 1 dedicated SDI output on HD-BNC
- 1 dedicated SDI output on fiber optic port (refer to **“Supported SFP Modules”**)
- 3 bi-directional SDI HD-BNCs
- 4 GPIO connections

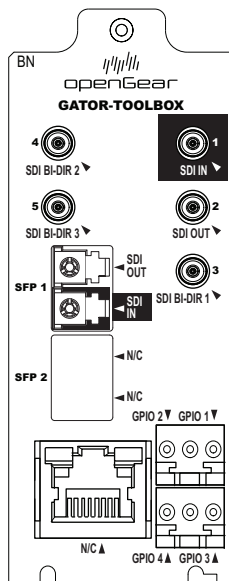

Figure 9 Cabling Designations — R4F-GATOR Rear Module

Physical Installation

Installing an GATOR-TOOLBOX card into the openGear frame requires you to remove the blank plates in the designation frame slots, install the required rear module into the frame rear panel, and then install the GATOR-TOOLBOX card into the required frame slot.

If you have questions pertaining to the installation of GATOR-TOOLBOX, contact us at the numbers listed in “**Contacting Technical Support**”. Our technical staff is always available for consultation, training, or service.

For More Information on...

- the technical specifications for the GATOR-TOOLBOX, refer to “**Technical Specifications**”.

Before You Begin

These installation guidelines assume the following:

- Ensure the openGear frame is properly installed. Refer to the **User Guide** for your frame.
- A valid IP addresses is available for the GATOR-TOOLBOX.
- If the rear module is already installed in the openGear frame, proceed to “**Installing the GATOR-TOOLBOX Card into an openGear Frame**”.

Static Discharge

Throughout this chapter, please heed the following cautionary note:



ESD Susceptibility — *Static discharge can cause serious damage to sensitive semiconductor devices. Avoid handling circuit boards in high static environments such as carpeted areas and when synthetic fiber clothing is worn. Always exercise proper grounding precautions when working on circuit boards and related equipment.*

Working with Fiber Optic Connectors



Caution — *Every time you are required to insert a connector into a device or mating sleeve, you must clean the connector. All exposed surfaces of the ceramic ferrule must be clean. Follow your facility practices of cleaning fiber optic connectors. Connectors must always be inserted into a device or have a dust cap on.*



Caution — *Never attempt to look down the barrel of a connected fiber or device transmitting an optical signal. The transmitted light is not in the visible spectrum and may cause permanent eye damage. Turn off all laser sources before disconnecting devices.*

The **R4F-GATOR** rear module supports optical Small Form-factor Pluggable (SFP) modules. Keep the following in mind when working with fiber optic connectors:

- ★ These instructions are for use by qualified service personnel only. Do not perform any servicing other than that contained in the following instructions unless you are qualified to do so.
- Connectors must always be inserted into a device or have a dust cap on.
- A poor optical connection is often similar to a poor electrical connection. Try removing the connector, cleaning, and re-inserting the connector. A bad connection can result in experiencing instability of signal, high loss, or a noisy signal.
- The SFP modules are hot-swappable.

Removing the Blank Plates from the Rear Panel

When a frame slot is not populated with an openGear card, a blank plate must be installed to ensure proper frame cooling and ventilation.



Notice — Installing the 8323AR-325 or 8323AR-327 rear modules in a frame other than the OGX-FR could damage the card, the rear module, or both.

To remove a blank plate from the openGear frame

1. Locate the slots in the openGear frame you wish to install the GATOR-TOOLBOX into.
2. If you are using an 8322AR-319C, it is recommended to use the following slot combinations:
 - Slots 1, 2, 3, 4
 - Slots 5, 6, 7, 8
 - Slots 9, 10, 11, 12
 - Slots 13, 14, 15, 16
 - Slots 17, 18, 19, 20
3. If you are using an 8323AR-325 or an 8323AR-327 it is recommended to use the following slot combinations:
 - Slots 1, 2
 - Slots 3, 4
 - Slots 5, 6
 - Slots 7, 8
 - Slots 9, 10
 - Slots 11, 12
 - Slots 13, 14
 - Slots 15, 16
 - Slots 17, 18
 - Slots 19, 20
4. Use a Phillips screwdriver to unfasten each blank plate from the openGear backplane.
5. Remove each blank plate from the chassis and set aside.

Installing the Rear Module into the openGear Frame

If the rear module is already installed in the openGear frame, proceed to “**Installing the GATOR-TOOLBOX Card into an openGear Frame**”.

To install a rear module into the openGear frame

1. For each retaining screw on the rear module, push the o-ring to the end of the screw (but not off the screw). This will help to align the rear module to the frame backplane in step 3.

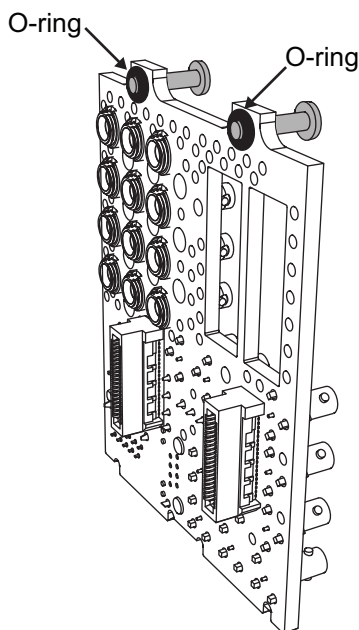

Figure 10 Location of the O-ring on the Rear Module

2. Seat the bottom of the rear module in the seating slots at the base of the openGear frame's backplane.
 3. Align the top holes of the rear module with the screw holes on the top-edge of the frame backplane.
 4. Using a Phillips screwdriver and the provided screw, fasten the rear module to the backplane.
- ★ Do not fully tighten the screws until after installing the card and you have verified that the GATOR-TOOLBOX card aligns with the rear module.

Installing the GATOR-TOOLBOX Card into an openGear Frame

The slot the GATOR-TOOLBOX installs into depends on the slot combination you installed the rear module in. This allows adequate spacing to avoid damaging the card, the cards installed in the neighboring slots, or both.

Refer to **Table 2** for valid slot combinations when using the 8322AR-319C or 8323AR-327 rear module.

Table 2 Card Slot Combinations — 8322AR-319C, 8323AR-327

Rear Module is Installed in	Card Installs into Slot	Daughter Card Installs into Slot ^a
Slots 1, 2, 3, 4	2	4
Slots 5, 6, 7, 8	6	8
Slots 9, 10, 11, 12	10	12
Slots 13, 14, 15, 16	14	16
Slots 17, 18, 19, 20	18	20

a. Applies to the GATOR-4A.

Refer to **Table 3** for valid slot combinations when using the 8323AR-325 or 8323AR-327 rear module.

Table 3 Card Slot Combinations — 8323AR-325, 8323AR-327

Rear Module is Installed in	Card Installs into Slot
Slots 1, 2	1
Slots 3, 4	3
Slots 5, 6	5
Slots 7, 8	7
Slots 9, 10	9
Slots 11, 12	11
Slots 13, 14	13
Slots 15, 16	15
Slots 17, 18	17
Slots 19, 20	19

To install the GATOR-TOOLBOX into the openGear frame

1. Locate the slot the GATOR-TOOLBOX card will slide into.
2. Verify that the GATOR-TOOLBOX card aligns with the rear module.
3. Using a Phillips screwdriver fasten the rear module to the backplane using the provided screws.
★ Do not over tighten the screws.
4. Hold the card by the edges and carefully align the card edges with the slot rails in the frame.
5. Fully insert the card into the frame until the card is properly seated in the rear module.

Cabling

If you have questions pertaining to the installation of GATOR-TOOLBOX, contact us at the numbers listed in “**Contacting Technical Support**”. Our technical staff is always available for consultation, training, or service.

For More Information on...

- the specifications for the GATOR-TOOLBOX, refer to “**Technical Specifications**”.

Cabling the Ethernet Port on the openGear Frame

The GATOR-TOOLBOX is connected to your network via the MFC-OG3-N or MFC-OGX-N in the openGear frame. This enables the GATOR-TOOLBOX to interface with other cards in the frame, and the computer running the DashBoard client. After a physical connection is established, DashBoard is used to configure the network settings for the GATOR-TOOLBOX.

- ★ The GATOR-TOOLBOX requires the MFC-OG3-N or MFC-OGX-N Network Controller card to be installed in the openGear frame. The MFC-8322-S does not support the GATOR-TOOLBOX.
- ★ You must provide an Ethernet connection to the openGear frame as outlined in the user guide that accompanied your frame.

Before You Begin

Contact your IT department before connecting to your facility network to ensure that there are no conflicts. They will provide you with an appropriate value for the IP Address, Subnet Mask, and Gateway for your GATOR-TOOLBOX.

For More Information on...

- downloading and installing DashBoard, refer to the *DashBoard User Guide*.
- configuring the Ethernet port on the openGear frame, refer to the *OGX-FR Series User Guide*.
- ★ Contact your network administrator if problems are experienced when connecting to a network hub.

Cabling for the Reference Input for an GATOR-TOOLBOX

The openGear frame provides two reference input connections that the GATOR-TOOLBOX can use as a reference source. Refer to the *User Guide* for your openGear frame to learn more about cabling these ports.

Three GATOR-TOOLBOX rear modules also include a **REF IN** HD-BNC that can assigned as a local reference input. This section outlines the cabling requirements for each rear module.

- ★ This section is not applicable when using the 8323AR-327 rear module.

For More Information on...

- specifying the reference source for your GATOR-TOOLBOX, refer to “**Reference Setup**”.

To connect a reference source to the GATOR-TOOLBOX rear module

1. Connect one end of a cable to the **REF IN** HD-BNC on the GATOR-TOOLBOX rear module. Refer to **Figure 11**, **Figure 12**, or **Figure 13**.
2. Connect the other end of the same cable to the applicable output port on the external reference source device.

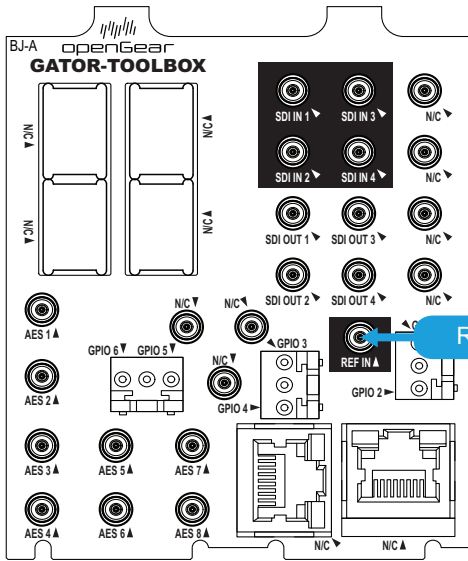

Figure 11 R3A-GATOR — REF IN

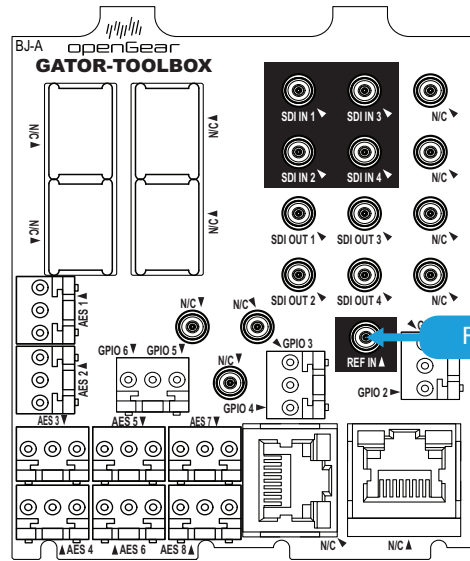

Figure 12 R3B-GATOR — REF IN

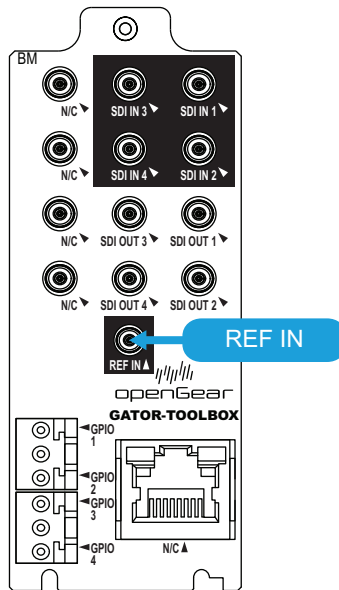

Figure 13 R4-GATOR — REF IN

Video Signal Cabling

Each rear module provides connections for SDI inputs and SDI outputs. The number of inputs and outputs is dependent on the rear module model you are using.

SDI Inputs

Connect your input video signals to the SDI IN HD-BNCs on the rear module as required.



Notice — Every time you are required to insert a connector into a device or mating sleeve, you must clean the connector. All exposed surfaces of the ceramic ferrule must be clean. Follow your facility practices of cleaning fiber optic connectors. Connectors must always be inserted into a device or have a dust cap on.

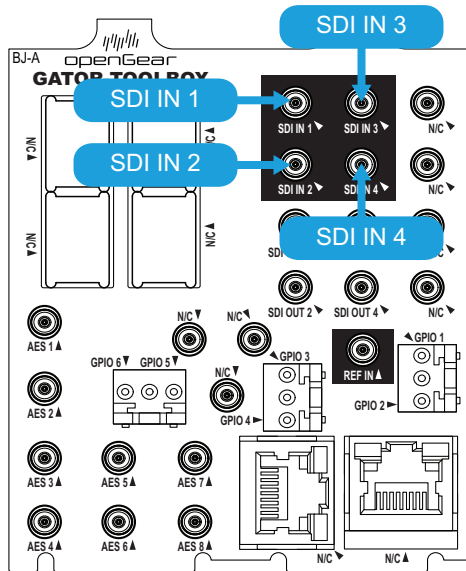

Figure 14 R3A-GATOR — SDI Inputs

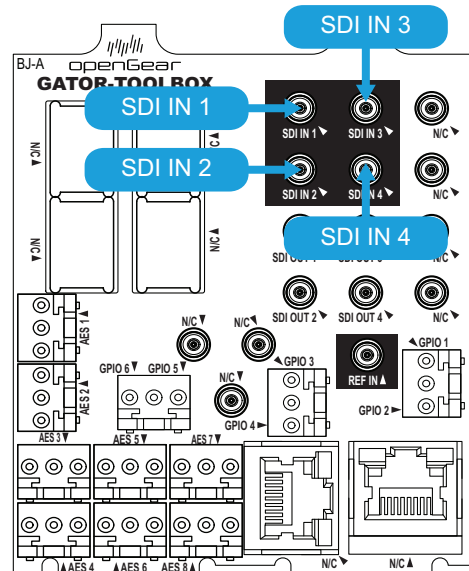

Figure 15 R3B-GATOR — SDI Inputs

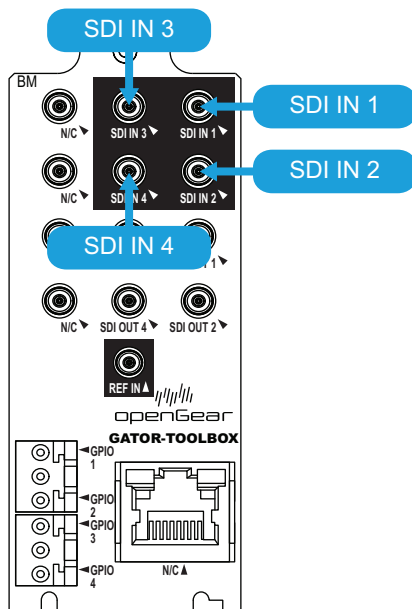

Figure 16 R4-GATOR — SDI Inputs

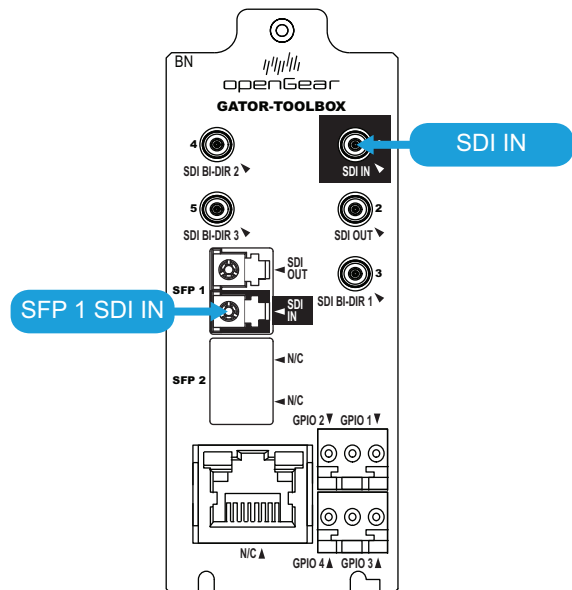

Figure 17 R4F-GATOR — SDI Inputs

SDI Outputs

Connect your destination devices to the SDI OUT HD-BNCs on the rear module as required.



Notice — Every time you are required to insert a connector into a device or mating sleeve, you must clean the connector. All exposed surfaces of the ceramic ferrule must be clean. Follow your facility practices of cleaning fiber optic connectors. Connectors must always be inserted into a device or have a dust cap on.

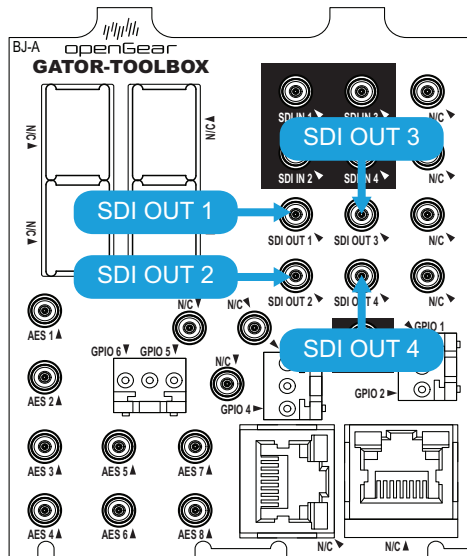

Figure 18 R3A-GATOR — SDI Outputs

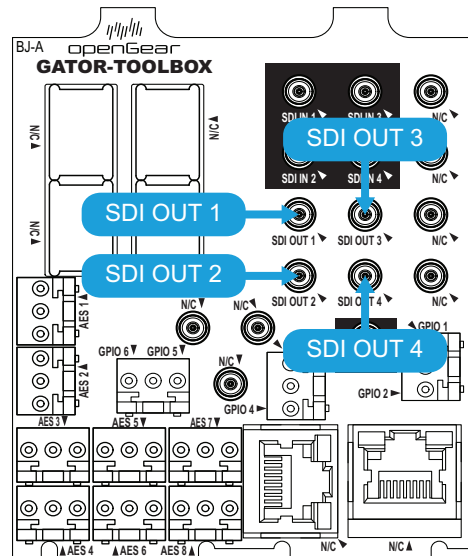

Figure 19 R3B-GATOR — SDI Outputs

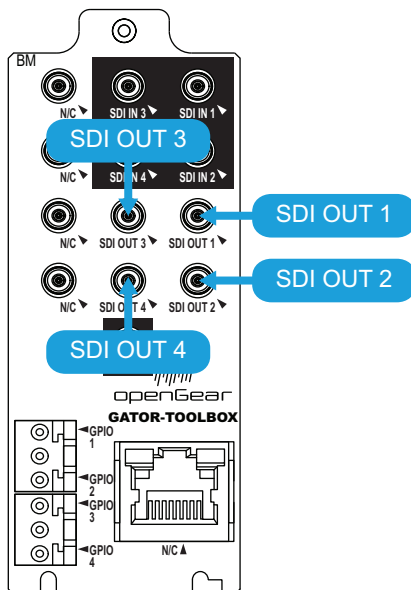

Figure 20 R4-GATOR — SDI Outputs

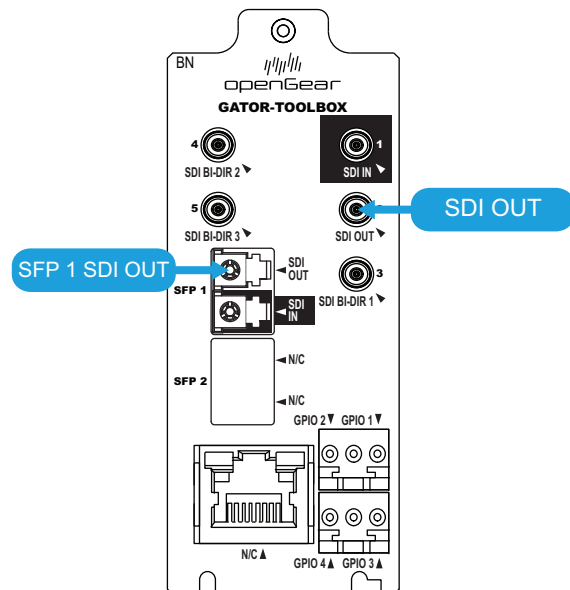

Figure 21 R4F-GATOR — SDI Outputs

Bi-directional Cabling

The R4F-GATOR (P/N 8323AR-327) rear module provides 3 SDI BNCs that are bi-directional.

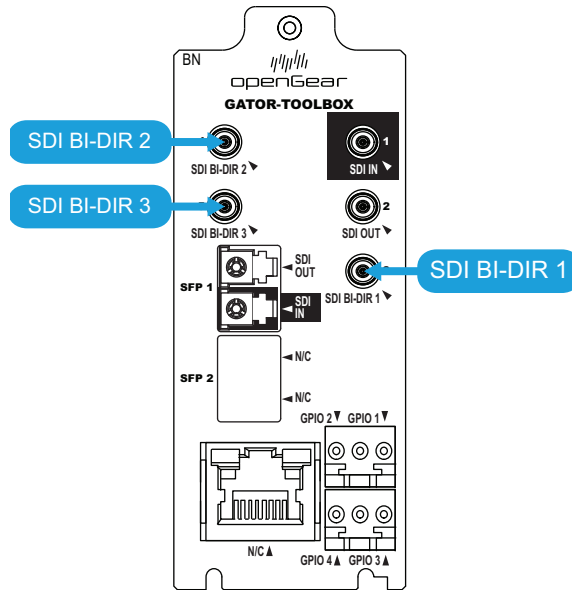

Figure 22 R4F-GATOR — Bi-directional BNCs

Audio Cabling

This section outlines the audio cabling designations for the applicable GATOR-TOOLBOX rear modules.

R3A-GATOR Cabling

The R3A-GATOR rear module provides eight unbalanced audio connections for AES sources via HD-BNC ports. (Figure 23)

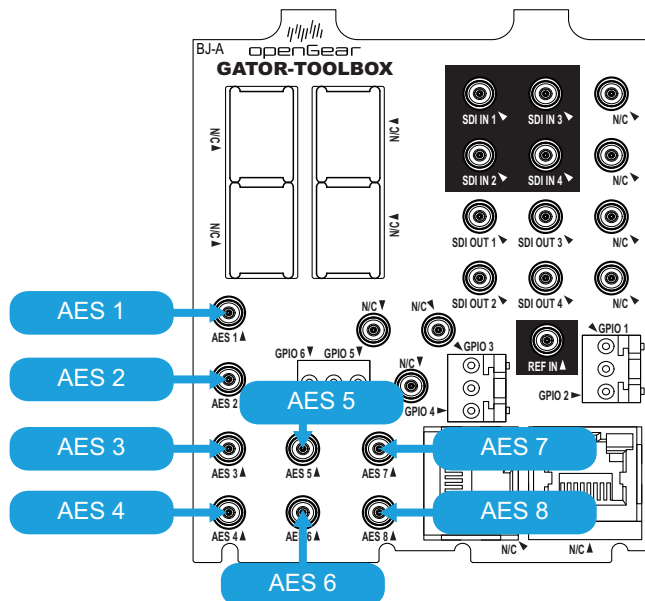

Figure 23 R3A-GATOR — AES Cabling

R3B-GATOR Cabling

The R3B-GATOR rear module provides eight balanced audio connections on 3-pin connectors.

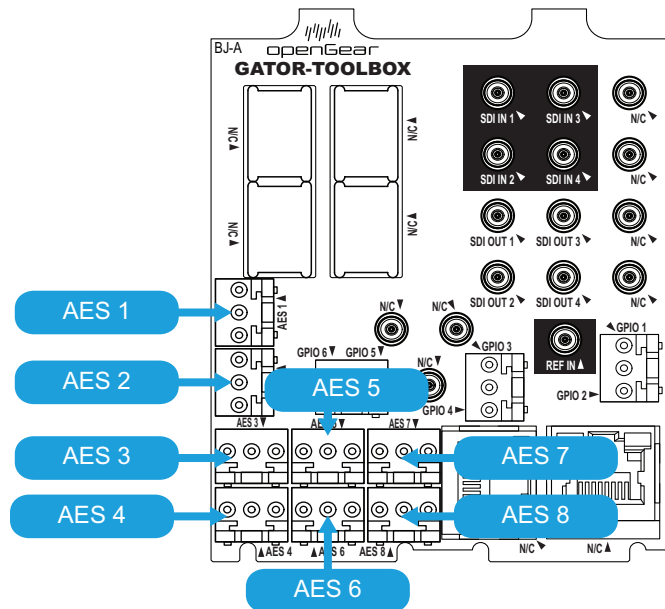
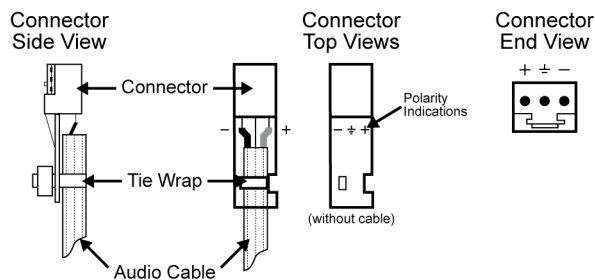

Figure 24 R3B-GATOR — AES Cabling

Cable your rear module using the following procedure.

To wire the audio for the R3B-GATOR

1. Insert an audio wire to the designated polarity slot on the connector of the rear module.



2. Use a tweaker screwdriver to tighten the corresponding capture screw.
3. Repeat steps 1 and 2 for each wire on each connector.
4. Once the cables are wired to the connectors, install the connectors on the terminal blocks for the rear module.

GPIO Cabling

The GATOR-TOOLBOX provides up to six General Purpose Input (GPI) and Tally ports to interface with external equipment. The number of available ports depends on the rear module (**Table 4**).

Table 4 Rear Modules — GPIO Ports

Rear Module	Number of GPIO Ports
R3A-GATOR	6
R3B-GATOR	6
R4-GATOR	4
R4F-GATOR	4

The GPIO ports are available on 3-pin connectors located on the rear module. The 3-pin mating connectors are provided with the rear module.

Ports are user programmable to be either an input (GPI) or an output (Tally). Electrically, the ports are set up for contact closure to ground, with 4.75Kohm pull-up resistor to +5V, so they default to a logical high state.

For More Information on...

- configuring the GPIO ports, refer to **“Configuring the GPI/Tallies”**.

R3A-GATOR Cabling

Figure 25 shows the GPIO designations for the R3A-GATOR rear module (P/N 8322AR-319C).

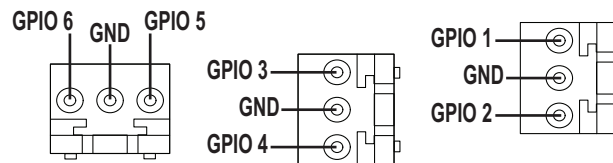

Figure 25 R3A-GATOR — GPIOs

R3B-GATOR Cabling

Figure 26 shows the GPIO designations for the R3B-GATOR rear module (P/N 8322AR-318D).

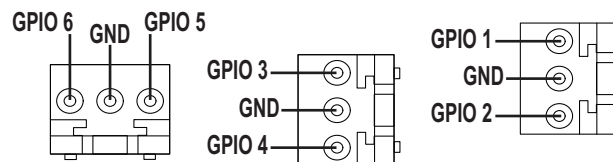

Figure 26 R3B-GATOR — GPIOs

R4-GATOR Cabling

Figure 27 shows the GPIO designations for the R4-GATOR rear module (P/N 8323AR-325).

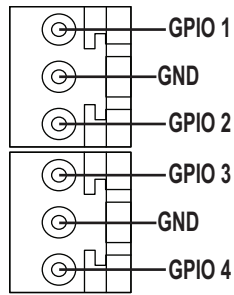

Figure 27 R4-GATOR — GPIOs

R4F-GATOR Cabling

Figure 28 shows the GPIO designations for the R4F-GATOR rear module (P/N 8323AR-327).

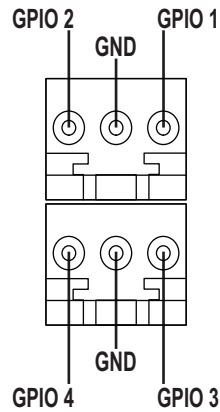

Figure 28 R4F-GATOR — GPIOs

Getting Started

This chapter provides instructions for launching DashBoard, and accessing the GATOR-TOOLBOX interfaces in DashBoard.

If you have questions pertaining to the operation of GATOR-TOOLBOX, contact us at the numbers listed in “**Contacting Technical Support**”. Our technical staff is always available for consultation, training, or service.

Before You Begin

Ensure that:

- An MFC-OG3-N or MFC-OGX-N Network Controller Card is installed in your OGX-FR frame.
- The openGear frame that houses the GATOR-TOOLBOX displays in the Basic Tree View of DashBoard.
- The GATOR-TOOLBOX displays as a sub-node in the OGX-FR frame tree.
- Your facility IT Department provided the required network settings to be assigned to the GATOR-TOOLBOX.

Launching DashBoard

DashBoard must run on a computer that has a physical wired ethernet connection. Wireless connections do not allow device discovery.

For More Information on...

- downloading and installing the DashBoard client software, refer to the *DashBoard User Guide*.
- the GATOR-TOOLBOX interfaces in DashBoard, refer to “**DashBoard Interface Overview**”.

To launch DashBoard

1. Ensure that you are running DashBoard software version 9.13 or higher.
2. Launch DashBoard by double-clicking its icon on your computer desktop.

Configuring the Initial Network Settings

Once the GATOR-TOOLBOX is physically installed and cabled to your facility network, you will need to assign it an initial IP address in order to gain full access to the card menus, options, and status fields in DashBoard. Establishing an initial IP address enables DashBoard to communicate with the GATOR-TOOLBOX and update the Basic Tree View with the GATOR-TOOLBOX sub-node.

★ This procedure requires a reboot of the card.

To assign the initial network settings for the GATOR-TOOLBOX

1. Launch DashBoard.
2. Expand the OGX-FR frame node to display a list of cards installed in that frame.
3. Double-click the **GATOR-TOOLBOX** node under the frame node.
The **Network** interface displays in DashBoard.
4. Select the **Network** tab.
5. Use the **Mode** menu to select **Static**.
6. Use the **Static IP Address** field to assign a unique IP address to the GATOR-TOOLBOX card.

7. Use the **Subnet Mask** field to assign the subnet mask for the card.
8. Use the **Gateway** field to specify the gateway for communications outside of the local area network (LAN) the card will use.
9. Click **Apply**.
The card is temporarily taken off-line during the reboot of the card to apply the new settings.
10. Verify the new network settings as follows:
 - a. Close the **Network** interface.
 - b. Refresh the Basic Tree View.
 - c. Expand the OGX-FR frame node to display a list of sub-nodes.
 - d. Verify that the GATOR-TOOLBOX displays as seen in the example below.

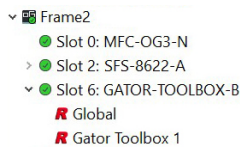

Accessing the GATOR-TOOLBOX Interfaces in DashBoard

The interfaces are accessed by expanding the GATOR-TOOLBOX sub-node in the DashBoard Tree View.

To access the GATOR-TOOLBOX interfaces in DashBoard

1. Launch DashBoard.
2. In the Basic Tree View of DashBoard, locate the openGear frame the GATOR-TOOLBOX is installed in.
3. Expand the openGear frame node to display a list of sub-nodes.
4. Locate the GATOR-TOOLBOX node in the openGear frame tree.
5. Expand the GATOR-TOOLBOX node to display a list of sub-nodes for the card.

In the following example, the user expanded the GATOR-TOOLBOX-B node in Slot 6.

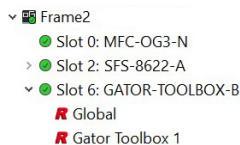

The first sub-node provides access to the **Global** settings for the card while each subsequent sub-node represents interfaces for configuring the features of the GATOR-TOOLBOX.

6. Double-click the **Global** sub-node to display that interface in the right pane of the DashBoard window.
- ★ If the **Global** sub-node is not available, the Network Settings are not properly configured. Open the Card page and it will present the Network Settings page.

There are two sets of tabs in the Global interface: Status (on the left), and Configuration (on the right). Use the tabs on the right to configure settings that impact the entire card (such as network settings, enabling licensed features, and enabling alarm reporting). Refer to “**Global Interface**” for a summary of the available menus and read-only fields in this interface.

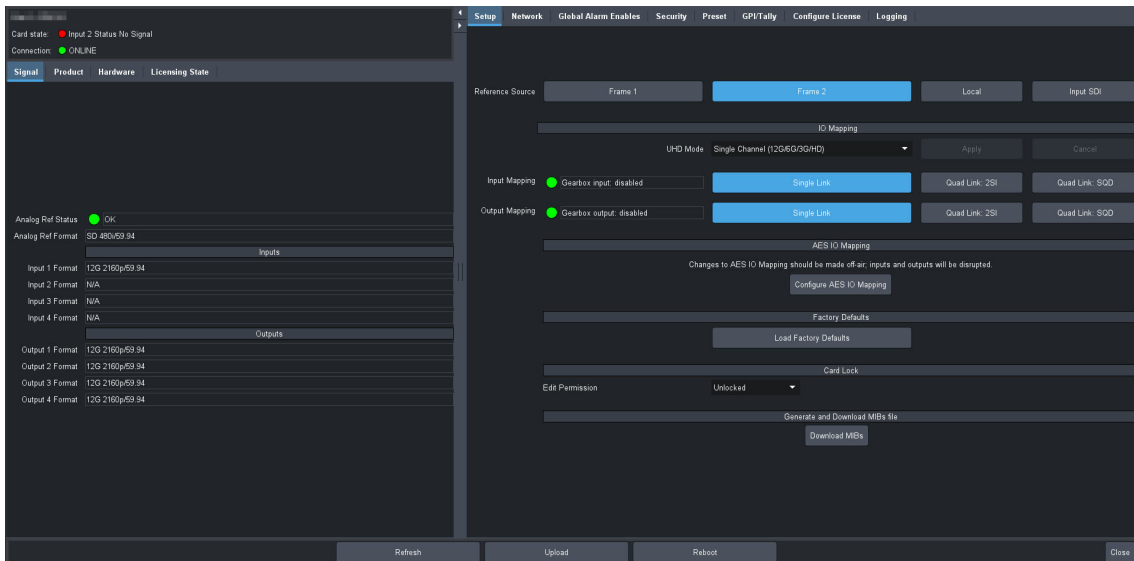

7. Double-click the **Gator Toolbox** sub-node to display the interface for that feature in the right pane of the Dashboard window.

The area on the left displays read-only fields that report the overall status of the inputs. The area on the right provides options to configure specific features of the card. Refer to “**Gator Toolbox Interfaces**” for a summary of the available menus and read-only fields in this interface.

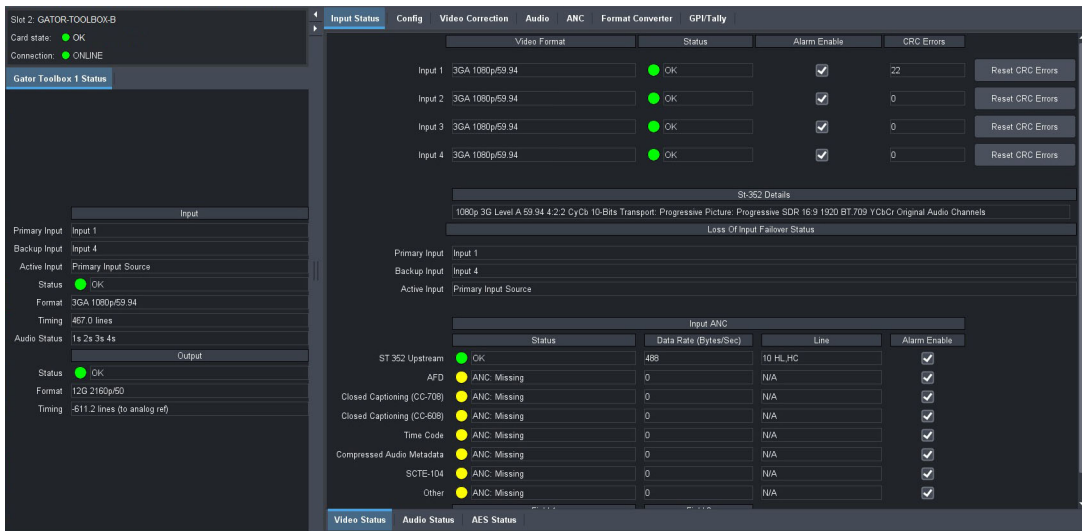

Configuring the Network Settings

This chapter outlines how to update the network settings assigned to the GATOR-TOOLBOX.

★ If difficulties or problems are experienced when assigning IP addresses, contact your network administrator.

Before You Begin

Ensure that:

- The OGX-FR frame that houses the GATOR-TOOLBOX displays in the Basic Tree View of DashBoard
- An MFC-OG3-N Network Controller Card installed in your OGX-FR frame
- The GATOR-TOOLBOX displays as a sub-node in the OGX-FR frame tree
- You have contacted your facility IT Department for the required settings to be assigned to the GATOR-TOOLBOX

Changing the Network Settings of the GATOR-TOOLBOX

Once you have establish connection to the card, you may want to change the IP address from the default setting to one that was provided by your IT Department.

★ Ross Video recommends using a static IP address.

To change the network settings for the GATOR-TOOLBOX

1. Display the **Global** interface as outlined in “**To access the GATOR-TOOLBOX interfaces in DashBoard**”.
2. Select the **Network** tab.
3. If you are manually configuring the Ethernet settings for the GATOR-TOOLBOX:
 - a. Use the **Mode** menu to select **Static**.
 - b. Use the **Static IP Address** field to specify the new static IP address for the GATOR-TOOLBOX. This is the address the card will use within the OGX-FR frame.
 - c. Use the **Subnet** field to specify the subnet mask for your network.
 - d. Use the **Static Gateway** field to specify the gateway for communications outside of the local area network (LAN) the card will use.
4. If you want the network settings to be automatically obtained, select **DHCP** from the **Mode** menu.
5. Click **Apply** to save the new settings.

★ The the GATOR-TOOLBOX card reboots automatically.

Dual Channel Mode Setup

The GATOR-TOOLBOX provides two processing modes: Single Channel (default) and Dual Channel. This chapter summarizes the steps to configure the GATOR-TOOLBOX in Dual Channel mode.

Overview

When in Dual Channel mode, the GATOR-TOOLBOX provides two independent channels with each channel supporting 3G and HD formats. **Figure 29** shows a workflow with the R4-GATOR, R3A-GATOR, or R3B-GATOR rear modules.

- ★ When using the R4F-GATOR rear module, the total number of SDI inputs and outputs depends on the mapping of the bi-directional SDI HD-BNCs. Refer to “**Using Dual Channel Mode and the R4F-GATOR Rear Module**” for details.

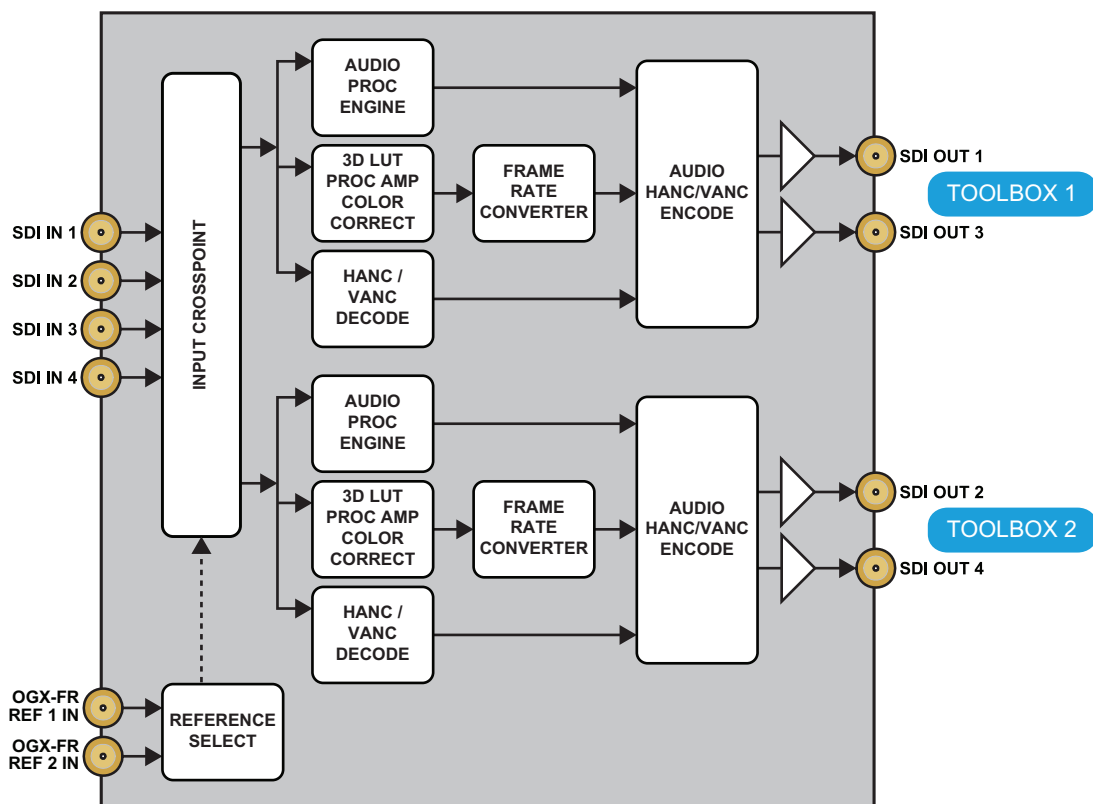

Figure 29 Example of a Dual Channel Workflow — R4-GATOR, R3A-GATOR, or R3B-GATOR

When in Dual Channel mode, the GATOR-TOOLBOX:

- performs format conversion on each channel to and from 720p/1080i/1080p including audio, video, and ANC (requires the GATOR TOOLBOX+FRC license);
- performs color correction and applies a 3D LUT on each channel to and from 720p/1080i/1080p (requires the GATOR TOOLBOX+HDR-LUT license);
- does not support the Gearbox feature.
- does not support the SFP port on the R4F-GATOR rear module. Refer to “**Using Dual Channel Mode and the R4F-GATOR Rear Module**”.

In DashBoard, the Tree View displays the channels as numbered sub-nodes (Gator Toolbox 1, Gator Toolbox 2). **(Figure 30)** Double-click a sub-node to display the configuration options for that specific channel.



Figure 30 DashBoard Tree View — Dual Channel Mode

Each Toolbox channel provides:

- access to up to 4 HD-BNC SDI inputs over coax cable
- the option to select any of the 4 SDI inputs to drive the dual 3G processing channels
- an SDI ancillary data decoder
- an SDI ancillary data encoder
- audio input de-embedder
 - › 16 audio channels from one of the selected SDI inputs
 - › 16 audio channels from the AES daughter card
- audio processing (sample rate conversion, delay, mapping, and re-embedding)
 - › 16 audio channels to the SDI output
 - › 16 audio channels to the AES Daughter card
- the ability to save or load 3D-LUT files
- up/down format conversion with audio/video frame sync in HD or 3G
- SD to HD/3G conversion for anamorphic 16:9, or pillar box aspect ratios
- HD/3G to SD letter box 4:3 aspect ratio

Before You Begin

Keep the following in mind when in Dual Channel mode:

- Each Toolbox channel output must be locked for a reliable signal output (the output frame rate is compatible (1:1 or 1:2) with the reference frame rate).
- Each Toolbox channel supports 16 audio channels, but one Toolbox channel can not use the audio channels of the other Toolbox channel as its source. However, both Toolbox channels can use any AES input as a source.
- The AES output can take either Toolbox 1 or Toolbox 2 embedded audio channels as the source. (via the Global > Setup > AES Output tab). After the selection, only the 16 channels of the selected Toolbox channel are available as an option on the Gator Toolbox node (1 or 2) > AES > Audio Source tab.
- When using the R4-GATOR, R3A-GATOR, or R3B-GATOR rear modules:
 - › Toolbox Channel 1 output is allocated to SDI OUT 1 and 3.
 - › Toolbox Channel 2 output is allocated to SDI OUT 2 and 4.

Specifying the Channel Mode

★ Changing the channel mode requires a reboot of the card.

To set the channel mode on the GATOR-TOOLBOX

1. Display the **Global** interface as outlined in “**To access the GATOR-TOOLBOX interfaces in DashBoard**”.
2. Select the **Setup** tab.
3. Locate the **IO Mapping** area of the tab.

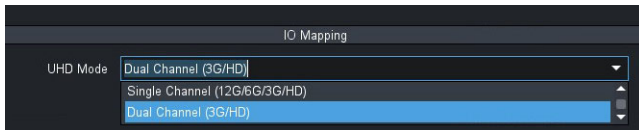

4. Use the **UHD Mode** menu to specify the number of processing channels for the card. Choose from the following:
 - **Single Channel (12G/3G/HD)** — The card provides a single channel that supports video formats up to 2160p. This is the default setting.
 - **Dual Channel (3G/HD)** — The card provides two independent channels that each support video formats up to 1080p.
5. Click **Apply**.
6. Monitor the reboot.

Displaying the Dual Channel Interfaces

The configuration options are the same as those displayed for Single Channel mode, only there is a set of options for each Toolbox channel. To configure a specific Toolbox channel, select its sub-node in the GATOR-TOOLBOX tree.

To display the interface for a Toolbox channel

1. In the Basic Tree View of DashBoard, locate the openGear frame the GATOR-TOOLBOX is installed in.
2. Expand the openGear frame node to display a list of sub-nodes.
3. Locate the GATOR-TOOLBOX node in the openGear frame tree.
4. Expand the GATOR-TOOLBOX node to display a list of sub-nodes for the card.

In the following example, the user expanded the GATOR-TOOLBOX node in Slot 9.

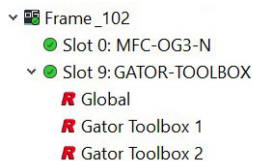

5. Double-click a channel sub-node to display its interface in the DashBoard window.
- ★ The interface displays the same tabs, menus, and parameters for channel 2 as for channel 1.

In the following example, the user selected **Gator Toolbox 1**.

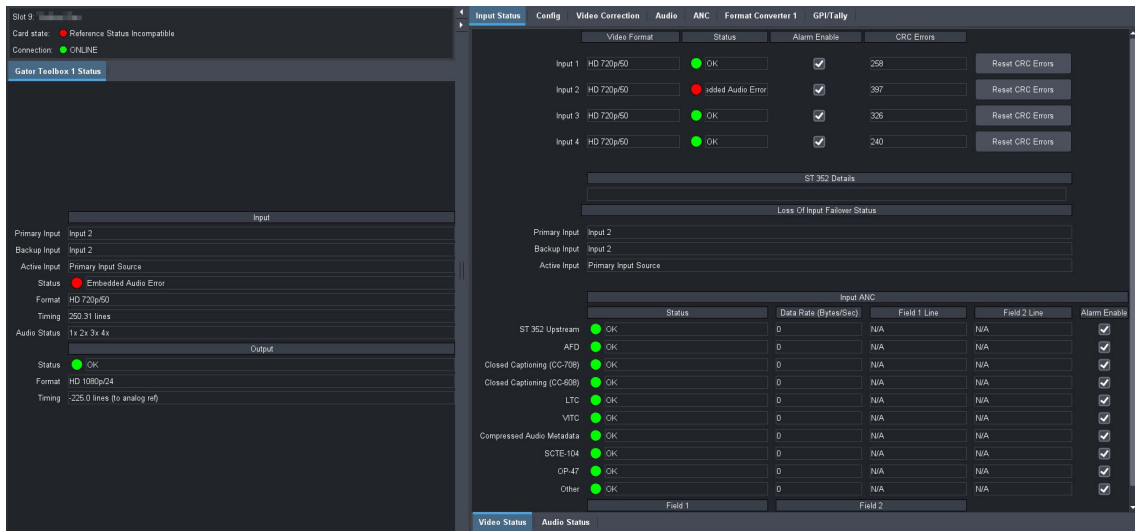

In the following example, the user selected **Gator Toolbox 2**.

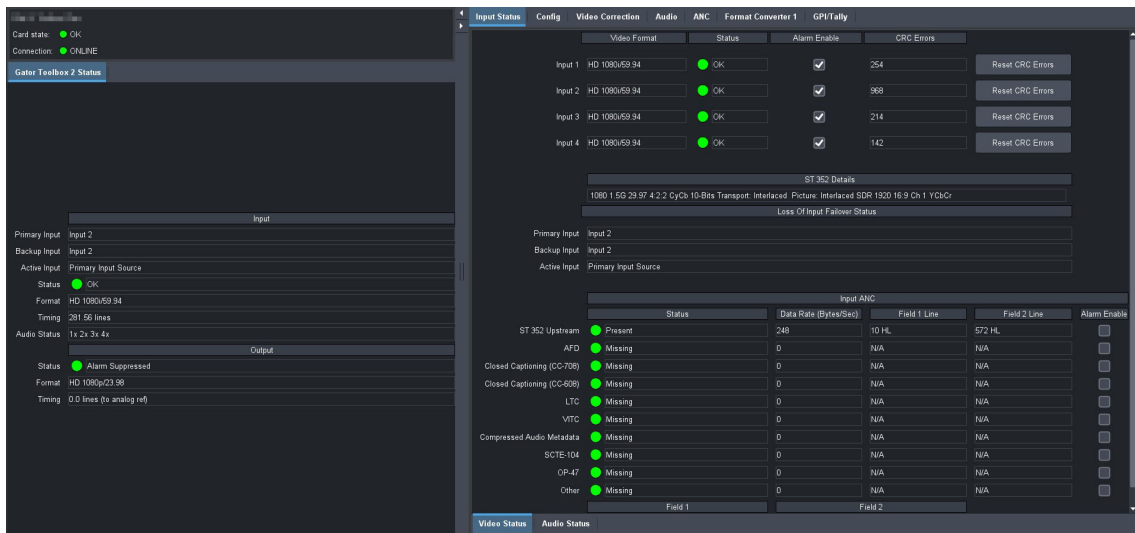

Installing License Keys for a Toolbox Channel

When operating in Dual Channel mode, you will need to enable an SDR/HDR conversion and Format Converter license key for each Toolbox channel.

To enable a license key on a Toolbox channel

1. Display the **Global** interface as outlined in “**Accessing the GATOR-TOOLBOX Interfaces in Dashboard**”.
 2. Select the **Configure Licenses** tab.
 3. Make a note of each character string in the **Request Code** field for the feature you wish to enable.
- ★ You will need a License Key for each Toolbox channel you wish to enable a license for.
4. Contact Ross Video using the information found in “**Contacting Technical Support**”.

- a. When you speak to your Technical Support representative, tell them your name, your facility name, and the **Request Code** from the **Configure Licenses** tab.
 - b. You will be given a License Key that must be entered in the applicable field in the **Licenses** table.
5. Enter the provided License Key in the applicable **Key** field in the **Configure Licenses** tab.
 6. Click **Apply** in the row for the License Key you entered in step 5.
 7. Verify that the **License Count** field for each license reports the correct number of licenses.
 8. Locate the **License Allocation** area of the tab.

Each row represents a Toolbox Channel, and each column represents a specific license type.

License Allocation		
Channel	Frame Rate Conversion	HDR 3D LUT File Support
Toolbox 1	<input type="checkbox"/>	<input type="checkbox"/>
Toolbox 2	<input type="checkbox"/>	<input type="checkbox"/>

9. Locate the row for the Toolbox channel you wish to configure.
10. Select **Enabled** for the required licensed feature to enable on the selected Toolbox channel.
11. Repeat steps 9 and 10 for the second channel.
12. Verify that the **License Count** field for each license reports the correct number of licenses allocated.

Mapping the Audio Channels for Dual Channel Mode

This section outlines how to mapping the audio channels for Dual Channel mode.

Keep the following in mind:

- The Toolbox channels share the AES Daughter card.
- Each Toolbox channel can de-embed simultaneously and independently the AES signals from the AES Daughter card.
- Any received AES signals can be assigned to any Toolbox channel.
- Only one Toolbox channel drives the AES signals to the AES Daughter card.

To globally map all AES channels to the output of a specific Toolbox Channel

1. Display the **Global** interface as outlined in “**To access the GATOR-TOOLBOX interfaces in DashBoard**”.
2. Select the **Setup** tab.
3. Locate the **AES IO Mapping** area of the tab.
4. Select a specific Toolbox channel to assign the AES output channels to it.

In the following example, the user assigned the AES outputs to Toolbox 1.

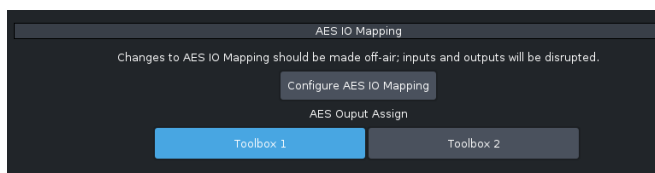

To customize the AES IO channel mapping for Dual Channel mode

1. Display the **Global** interface as outlined in “To access the GATOR-TOOLBOX interfaces in DashBoard”.

2. Select the **Setup** tab.

3. Locate the **AES IO Mapping** area of the tab.

4. Click **Configure AES IO Mapping**.

The AES IO Mapping dialog opens.

5. To configure an AES channel as an input:

a. Locate the row for the AES channel you wish to map.

b. Click **Input**.

6. To assign an AES channel to an output:

a. Locate the row for the AES channel you wish to map.

b. Click **Output**.

In the following example, the user mapped AES 1-3 as Inputs, and AES 4-8 as Outputs.

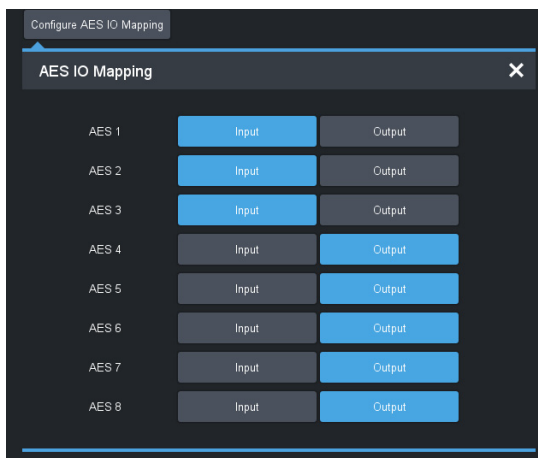

7. Close the AES IO Mapping dialog.

8. Select the **Toolbox** channel to map the AES IO.

In the following example, the user selected to map Toolbox Channel 2.

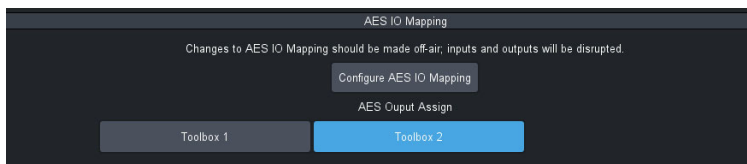

To configure the AES outputs for a Toolbox channel

1. Display the **Toolbox** channel that was mapped in step 8 in the previous procedure.

2. Select **Audio > AES**.

In the following example, the user is configuring AES 4-8 for Toolbox 2.

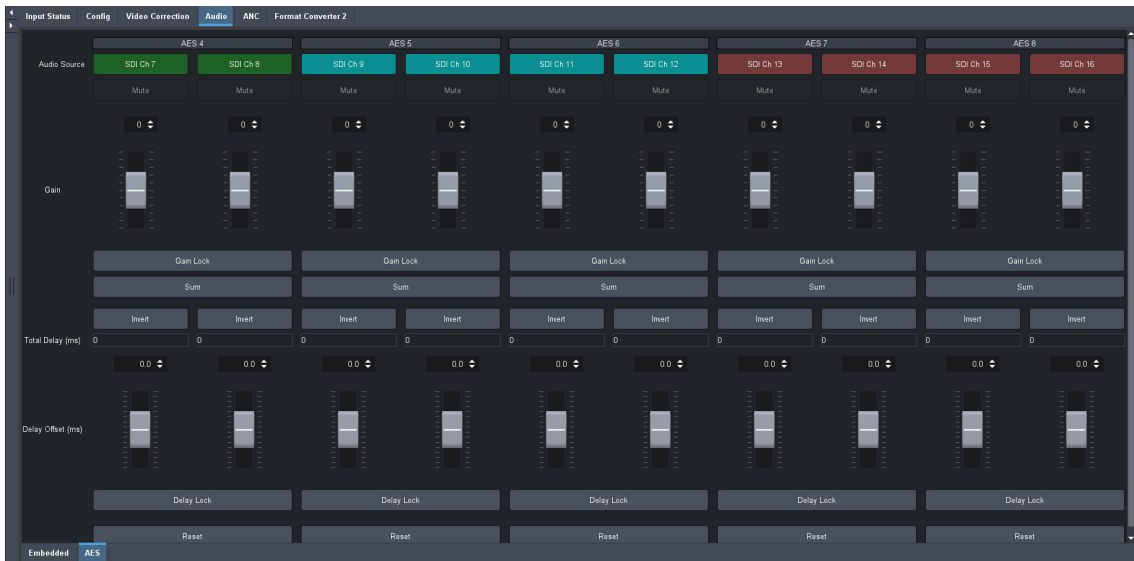

3. Proceed to configure the AES outputs as outlined in **“To configure the AES outputs”**.

For More Information on...

- options for processing the embedded audio input, refer to **“Configuring the AES Outputs”**.

Using Dual Channel Mode and the R4F-GATOR Rear Module

The R4F-GATOR rear module provides one SDI input, one SDI output, and three bi-directional BNCs. The bi-directional BNCs can be assigned as inputs or outputs.

Figure 31 shows the R4F-GATOR rear module configured with two SDI inputs and three SDI outputs.

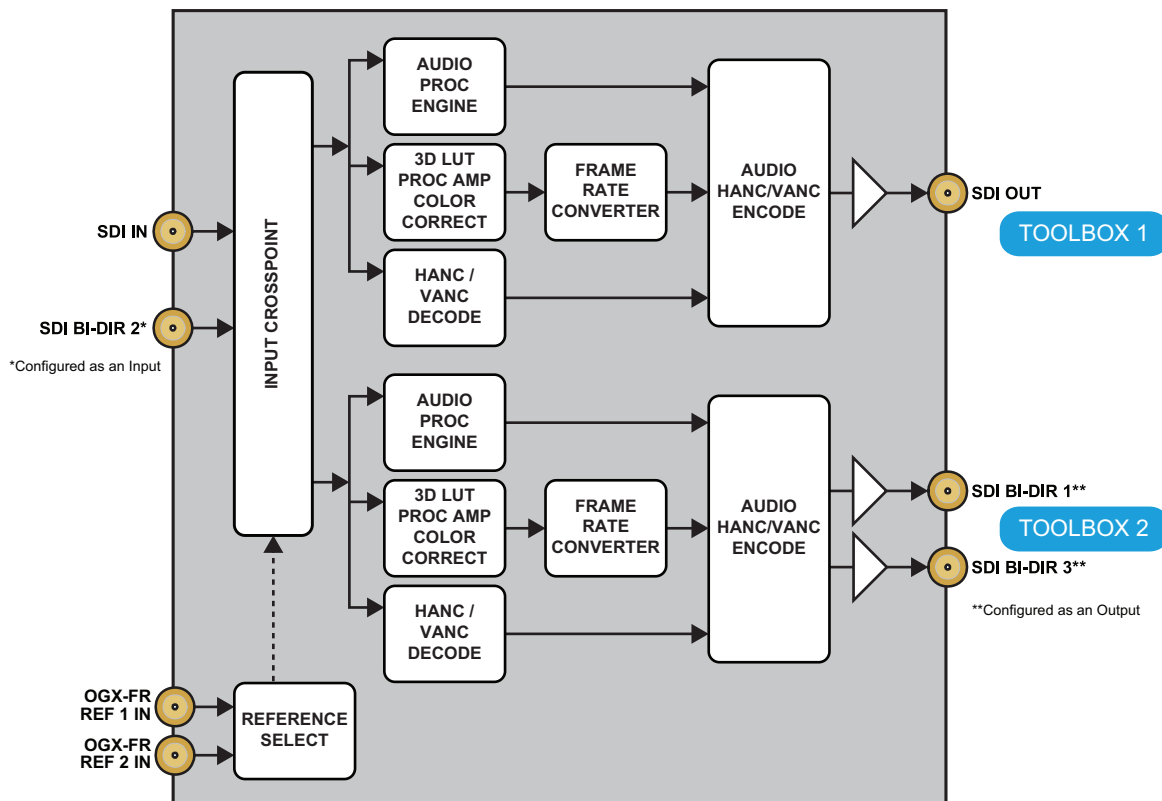

Figure 31 Example of a Dual Channel Workflow — R4F-GATOR

Figure 32 shows the R4F-GATOR rear module configured with one SDI input and four SDI outputs.

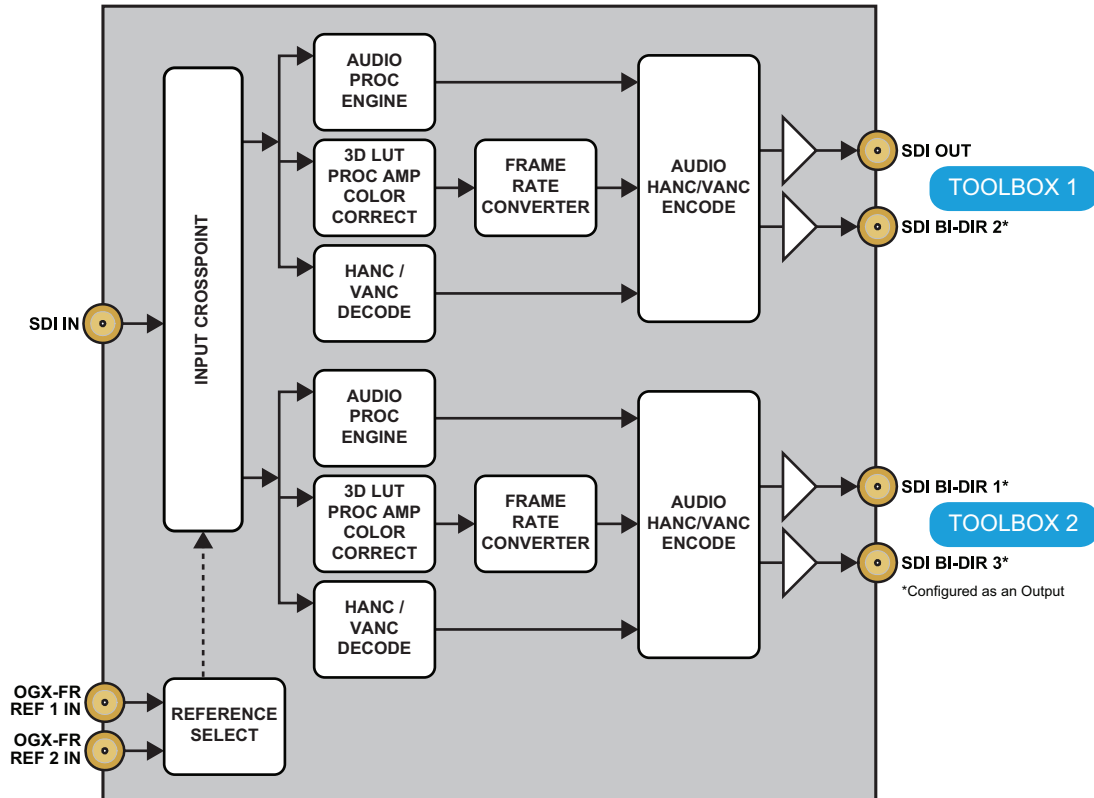

Figure 32 Example of a Dual Channel Workflow — R4F-GATOR

Keep the following in mind when configuring the GATOR-TOOLBOX for Dual Channel mode when using the R4F-GATOR rear module:

- The input and output fiber optic ports are unavailable in Dual Channel mode.
- The SDI IN port of SFP 1 is (Input Fiber) is unavailable as a Reference Source.
- The dedicated SDI input BNC and dedicated SDI output BNC are automatically allocated to Toolbox 1.
- If you wish to use Toolbox 2, you will need to assign at least one bi-directional BNC as an SDI output.
- The three bi-directional BNCs are allocated to Toolbox 2 as follows:
 - › Any bi-directional BNC assigned as input to the Toolbox 2 channel.
 - › Only BI-DIR 1 and 3 can be assigned as outputs to the Toolbox 2 channel.

For More Information on...

- the R4F-GATOR cabling designations, refer to “**R4-GATOR Rear Module**”.
- mapping the bi-directional HD-BNCs, refer to “**Bi-directional Mapping**”.
- cabling the R4F-GATOR rear module, refer to “**Bi-directional Cabling**”.

Loss of Input Failover Mode

For each Toolbox channel, you can specify which SDI video signal (Input 1, 2, 3, or 4; SFP 1 on the R4F-GATOR) is the primary and backup using the options in the GATOR-TOOLBOX > Config tab for the specific Toolbox channel.

During a loss of input, each Toolbox channel will switch to its backup source if the failover conditions are met.

For More Information on...

- configuring the video sources, refer to **“Specifying the Primary and Backup Video Sources”** and **“Loss of Input Failover Mode”**.

GPIOs and Dual Channel Mode

When operating in Dual Channel mode, the GPI/Tally tab updates to provide the option to assign a GPI/Tally port to a specific Toolbox channel. By default, all ports are assigned to Toolbox 1.

If the Toolbox Channel is assigned to a GPIO port with the Function set to:

- Tally Failover Active — the GPIO port will still trigger when the card enters the failover state. It reflects whether the card is in failover state, either by Force Failover or automatic failover.
- GPI Force Failover — the GPIO port will still trigger/enable/disable the Force Failover option.

For More Information on...

- assigning a function to the GPIO ports, refer to **“Configuring the GPI/Tallies”**.

Licensed Features

The GATOR-TOOLBOX has software licenses for enabling functions and features of the card. This chapter outlines the available software licensed features, and how to install a software key for a licensed feature.

License Keys Overview

Table 5 provides a brief summary on the types of licensed features available for the GATOR-TOOLBOX.

Table 5 List of GATOR-TOOLBOX Licensed Features

License	Description
GATOR TOOLBOX+UHD	Enables 2160p video formats including 6G-SDI, 12G-SDI, and Quad-link
GATOR TOOLBOX+FRC	Enables format conversion
GATOR TOOLBOX+HDR-LUT	Enables 3D-LUT transforms for HDR conversion.

Installing a License Key

Ross Video uses license keys to control user access to specific GATOR-TOOLBOX features. You can obtain a key for a GATOR-TOOLBOX licensed feature from Ross Video Technical Support.

★ If the GATOR-TOOLBOX is configured for Dual Channel mode, refer to “**Installing License Keys for a Toolbox Channel**” for installation details.

To install a license key

1. Display the **Global** interface as outlined in “**Accessing the GATOR-TOOLBOX Interfaces in DashBoard**”.
2. Select the **Configure License** tab.
3. Make a note of the character string in the **Request Code** field for the feature you wish to enable.
4. Contact Ross Video using the information found in “**Contacting Technical Support**”.
 - a. When you speak to your Technical Support representative, tell them your name, your facility name, and the **Request Code** from the **Configure License** tab.
 - b. You will be given a License Key that must be entered in the applicable field in the **Licenses** table.
5. Enter the provided License Key in the applicable **Key** field in the **Configure License** tab.
6. Click **Apply** in the row for the License Key you entered in step 5.
7. If you are operating in Dual Channel mode:
 - a. Verify that the **License Count** field for each license reports the correct number of licenses.
 - b. Locate the **License Allocation** area of the tab.

Each row represents a Toolbox Channel, and each column represents a specific license type.
 - c. Locate the row for the Toolbox channel you wish to configure.
 - d. Select **Enabled** for the required licensed feature to enable on the selected Toolbox channel.

- e. Repeat steps c and d for the second channel.
- f. Verify that the **License Count** field for each license reports the correct number of licenses allocated.

Disabling a License Key

Disabling a License Key removes user access to the GATOR-TOOLBOX features associated with that License Key.

★ To re-enable the features, you will need to contact Ross Technical Support and request a new License Key.

To disable a GATOR-TOOLBOX license key

1. Display the **Global** interface as outlined in “**Accessing the GATOR-TOOLBOX Interfaces in DashBoard**”.
2. Select the **Configure License** tab.
3. Clear the box for the license you wish to disable (the box no longer displays a check-mark).

Reference Setup

This chapter outlines the frame rate compatibility, and how to configure and monitor the reference signal the GATOR-TOOLBOX will use for timing purposes.

Frame Rate Compatibility

The GATOR-TOOLBOX video output frame rate must match the frame rate of the selected reference frame rate. **Table 6** outlines the GATOR-TOOLBOX frame rate compatibility.

- ★ It is recommended to use an interlaced analog or digital reference when using an interlaced video output format, with both running at the same frame rate.

Table 6 Reference/SDI Output Format Compatibility

Reference Format	SDI Video Output Format ^a
480i 59.94Hz	720p 59.94Hz
	1080i 59.94Hz
	1080p 29.97Hz
	1080p 59.94Hz
	2160p 29.97Hz
	2160p 59.94Hz
480i 60Hz	480i 60Hz
	720p 60Hz
	1080i 60Hz
	1080p 60Hz
	2160p 60Hz
576i 50Hz	576i 50Hz
	720p 50Hz
	1080i 50Hz
	1080p 25Hz
	1080p 50Hz
	2160p 25Hz
	2160p 50Hz
720p 50Hz	576i 50Hz
	720p 50Hz
	1080p 50Hz
	2160p 50Hz
720p 59.94Hz	720p 59.94Hz
	1080p 59.94Hz
	2160p 59.94Hz

Table 6 Reference/SDI Output Format Compatibility (Continued)

Reference Format	SDI Video Output Format ^a
720p 60Hz	480i 60Hz
	720p 60Hz
	1080p 60Hz
	2160p 60Hz
1080i 50Hz	576i 50Hz
	720p 50Hz
	1080i 50Hz
	1080p 25Hz
	1080p 50Hz
	2160p 25Hz
	2160p 50Hz
1080i 59.94Hz	720p 59.94Hz
	1080i 59.94Hz
	1080p 29.97Hz
	1080p 59.94Hz
	2160p 29.97Hz
	2160p 59.94Hz
1080i 60Hz	480i 60Hz
	720p 60Hz
	1080i 60Hz
	1080p 60Hz
	2160p 60Hz
1080p 23.98Hz	1080p 23.98Hz
	2160p 23.98Hz
1080p 24Hz	1080p 24Hz
	2160p 24Hz
1080p 50Hz	720p 50Hz
	1080p 50Hz
	2160p 50Hz
1080p 59.94Hz	720p 59.94Hz
	1080p 59.94Hz
	2160p 59.94Hz

Table 6 Reference/SDI Output Format Compatibility (Continued)

Reference Format	SDI Video Output Format ^a
1080p 60Hz	480i 60Hz
	720p 60Hz
	1080p 60Hz
	2160p 60Hz
1080pSF 23.98Hz	1080psF 23.98Hz
	1080psF 24Hz
1080pSF 24Hz	1080psF 23.98Hz
	1080psF 24Hz

a. UHD formats require the GATOR TOOLBOX+UHD license. Refer to “Licensed Features” for details.

Specifying a Global Reference Source

There are four options to select an external analog or digital reference source: Frame 1, Frame 2, Local, and Input SDI. Once selected, the GATOR-TOOLBOX video output timing will be locked to that reference source. Keep the following in mind:

- The Local option is not applicable when using the 8323AR-327 rear module as this module does not provide a REF IN connection.
- When in Dual Channel mode, the Global > Setup > Reference Source is used to lock the video outputs of both Toolbox video output channels.
- To lock properly, the reference frame rate and the video output frame rate should be in a ratio of 1:1 or 1:2.
- It is possible to offset the GATOR-TOOLBOX video output timing relative to the selected reference with the Horizontal Delay and the Vertical Delay options in Dashboard. Refer to “**Adjusting the Output Timing**” for details.

To specify a global reference source for the GATOR-TOOLBOX

1. Display the **Global** interface as outlined in “**Accessing the GATOR-TOOLBOX Interfaces in Dashboard**”.
2. Select the **Setup** tab.
3. Use the **Reference Source** options to specify the source for the reference input signal.

Monitoring the Reference Signal via Dashboard

The reference signal must be stable at all time. Any reference signal disruptions will cause the GATOR-TOOLBOX video output to re-lock with severe display artifacts.

The status of the GATOR-TOOLBOX may be monitored via its fields in the Dashboard client software or the LEDs located on the front panel of the chassis. In the case of a reference signal loss, the **Ref Status** field in Dashboard reports “**Unlocked**” and the GATOR-TOOLBOX video output free-runs.

To configure the reference alarm for the GATOR-TOOLBOX

1. Display the **Global** interface as outlined in “**Accessing the GATOR-TOOLBOX Interfaces in Dashboard**”.
2. Select the **Global Alarm Enables** tab.

3. Select the **Reference Format** box to enable the Card state status field, located in the top left corner of the Global interface, to report when the reference signal is not detected.

Basic Video Configuration

This chapter outlines how to specify the output format and video source, adjust the timing, and summarizes what the card will do during a loss of the input signal.

For More Information on...

- specifying the channel mode on the GATOR-TOOLBOX, refer to “**Dual Channel Mode Setup**”.

Mapping the GATOR-TOOLBOX I/O

The GATOR-TOOLBOX enables you to configure the inputs and outputs as Single Link, or Quad Link (2SI or SQD).

To assign an I/O Mapping mode

1. Display the **Global** interface as outlined in “**Accessing the GATOR-TOOLBOX Interfaces in DashBoard**”.
2. Select the **Setup** tab.
3. Locate the **IO Mapping** area.
4. In the **Inputs** row, specify how to map the GATOR-TOOLBOX inputs. Choose from the following:
 - **Single Link** — The GATOR-TOOLBOX ingests one signal per SDI IN port. This is the default.
 - **Quad Link: 2SI** — The GATOR-TOOLBOX ingests four 3Gbps Level A 2SI signals. Refer to “**Configuring 2SI Quad Link**”. This option is not available when operating in Dual Channel mode.
 - **Quad Link: SQD** — The GATOR-TOOLBOX ingests four 3Gbps SQD signals. Refer to “**Configuring SQD Quad Link**”. This option is not available when operating in Dual Channel mode.
 - **Fiber** — The GATOR-TOOLBOX ingests one 12Gbps signal via the SDI IN connection of SFP 1 and outputs one 12Gbps via the SDI OUT connection of SFP 1. The Output Mapping is automatically set to Single Link and cannot be changed. This option only displays when using the 8323AR-327 rear module.
5. In the **Outputs** row, specify how to map the GATOR-TOOLBOX outputs. Choose from the following:
 - **Single Link** — The GATOR-TOOLBOX outputs a single SDI signal on each SDI OUT port. This is the default.
 - **Quad Link: 2SI** — The GATOR-TOOLBOX outputs four 3Gbps Level A 2SI signals. Refer to “**Configuring 2SI Quad Link**”. This option is not available when operating in Dual Channel mode.
 - **Quad Link: SQD** — The GATOR-TOOLBOX outputs four 3Gbps SQD signals. This option is unavailable when the Input Mapping field is set to Quad Link: SQD. Refer to “**Configuring SQD Quad Link**”. This option is not available when operating in Dual Channel mode.

Bi-directional Mapping

The R4F-GATOR (P/N 8323AR-327) rear module provides three bi-directional SDI HD-BNCs that can be mapped as either inputs or outputs.

For More Information on...

- cabling the R4F-GATOR rear module, refer to “**Bi-directional Cabling**”.

To map the bi-directional ports

1. Display the **Gator Toolbox** interface as outlined in “**Accessing the GATOR-TOOLBOX Interfaces in Dashboard**”.

The Setup tab is automatically selected.

2. Click **Configure Bi-directional mapping**.

The **Bi-directional Mapping** dialog opens. Each row represents a specific bi-directional SDI HD-BNC.

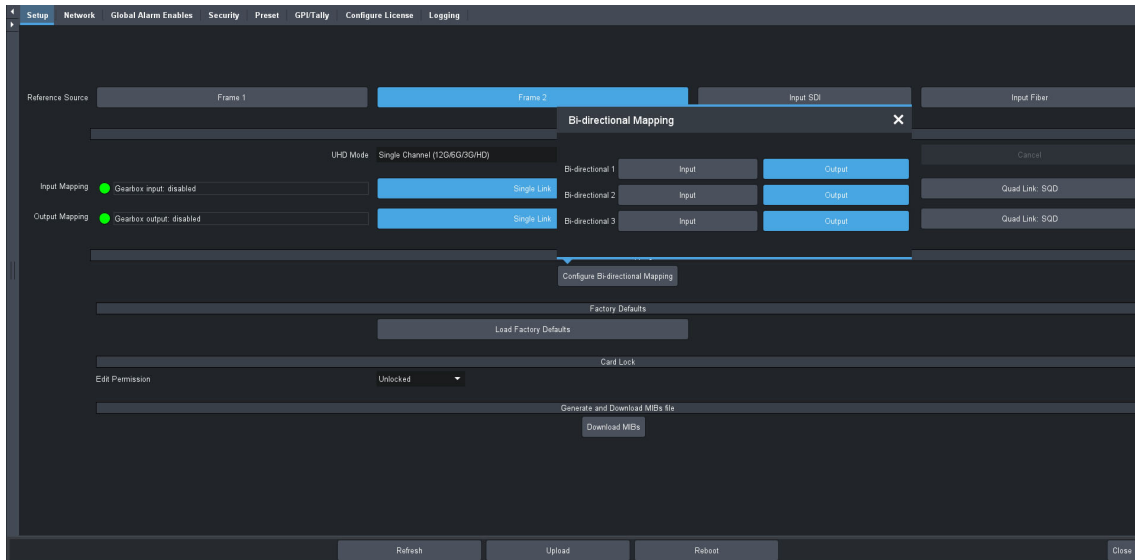

3. Assign each SDI HD-BNC to a function. Choose from the following:

- **Input** — assigns the SDI HD-BNC as an input and is active in the Toolbox > Input Status > Video sub-tab.
- **Output** — assigns the SDI HD-BNC as an output. Any global output settings are now also applied to this SDI HD-BNC. This SDI HD-BNC is reported as Not Applicable in the Toolbox > Input Status > Video sub-tab.

4. Close the dialog.

Video Input Setup

By default, the GATOR-TOOLBOX card provides a Loss of Input Failover feature where the user can manually switch from the primary SDI input signal to a secondary (backup) SDI input signal. You have the option to configure the card so that it stays on the backup SDI input signal until you manually switch the card back to the primary signal, or to enable the card to automatically switch.

★ On manual failover, the card will perform a clean/quiet switch if both SDI inputs are stable and the same video format.

Specifying the Primary and Backup Video Sources

You can specify which SDI video signal is the primary and backup using the options in the GATOR-TOOLBOX > Config tab.

★ This feature is only available when the Input Mapping mode is set to Single Link or Fiber.

To specify the primary and backup video sources

1. Display the **Gator Toolbox** interface as outlined in “**Accessing the GATOR-TOOLBOX Interfaces in Dashboard**”.
- ★ If the card is operating in Dual Channel mode, double-click the tree sub-node for the Toolbox channel you want to configure. Refer to “**To display the interface for a Toolbox channel**”.
2. Select the **Config** tab.
3. Locate the **Video Input** area of the tab.
4. Click **Configure Loss of Input**.
The **Loss of Input** dialog opens.

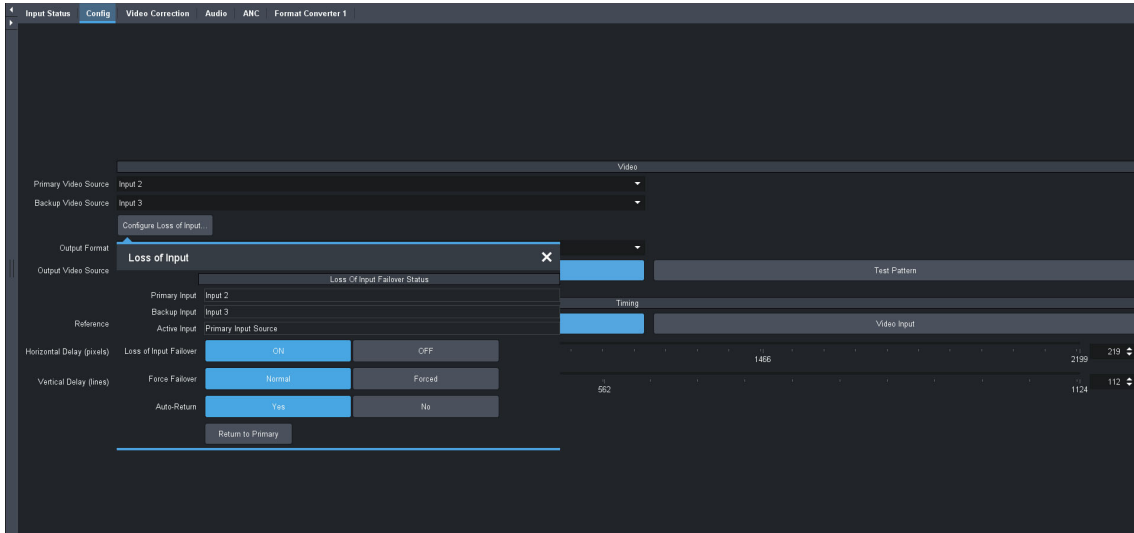

5. Use the **Primary Input** menu to specify an SDI input signal as the primary signal for the Loss of Input Failover mode.
- ★ You cannot assign the same SDI signal as both the **Primary Input** and the **Backup Input**.
6. Use the **Backup Input** menu to specify an SDI input signal as the backup signal for the Loss of Input Failover mode.

Loss of Input Failover Mode

There are two Loss of Input Failover modes: automatic or manual. By default, the card automatically switches the signals from primary to secondary when a loss of input occurs. Or, you can choose to configure the card to wait until the user decides to manually switch the signals by clicking.

- ★ When operating in Dual Channel mode, you configure each Toolbox channel independently for the Loss of Input Failover. Each Toolbox channel will switch to its backup source if the failover conditions are met.

To define the behavior of the Loss of Input Failover mode

1. In the **Loss of Input** dialog, locate the **Auto-Return** options.

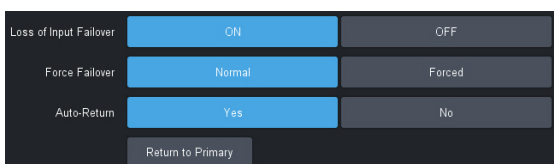

2. Use the **Auto-Return** options to specify whether the card automatically returns to the Primary Input source when a valid signal is detected (**Yes**), or whether the user must manually perform the switch (**No**).
3. In the **Loss of Input** dialog, locate the **Force Failover** options.
4. Use the **Force Failover** options to determine when the failover occurs. Choose from the following:
 - ★ When forcing a switchover, the GATOR-TOOLBOX performs a clean/quiet switch between inputs if the signals are both valid and the same format.
 - **Normal** — When a loss of input occurs, the card automatically switches to the other video source.
 - **Forced** — The user manually switches to the other video source by toggling the **Return to** button (located at the bottom of the **Loss of Input** dialog).

To enable Failover mode and switch the SDI input signals

1. In the **Loss of Input** dialog, locate the **Loss of Input Failover** options.
2. Click **ON**.

The **ON** button automatically is lit (active) and the card switches from one signal to the other.

To manually force a switch between SDI input signals

1. In the **Loss of Input** dialog, ensure the **Force Failover** is set to **Forced**.
2. Toggle the **Return to** button.

The input signal is switched and the button updates to display one of the following labels:

- **Return to Primary** — When the button displays this label, the card is using the Backup input signal. Clicking this button again switches the input to the Primary signal.
- **Return to Backup** — When the button displays this label, the card is using the Primary input signal. Clicking this button again switches the input to the Backup signal.

Verifying the Active SDI Input Signal

You can monitor the primary and backup SDI input signals via the **Input Status** tab in Dashboard.

To verify the current active SDI input signal

1. Display the **Gator Toolbox** interface as outlined in “**Accessing the GATOR-TOOLBOX Interfaces in Dashboard**”.
- ★ If the card is operating in Dual Channel mode, double-click the tree sub-node for the Toolbox channel you want to configure. Refer to “**To display the interface for a Toolbox channel**”.
2. Select the **Input Status** tab.
3. Locate the **Loss of Input Failover Status** area of the tab.

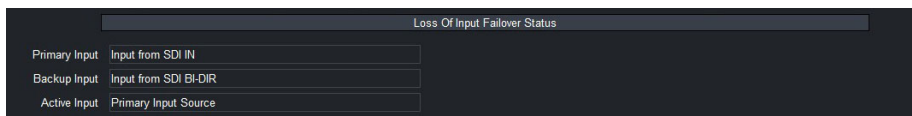

4. Use the **Primary Input** field to determine which SDI input signal is assigned as the Primary Input Video Source.
5. Use the **Backup Input** field to determine which SDI input signal is assigned as the Backup Video Source.
6. Use the **Active Input** field to determine which SDI input signal is currently active and in use.

- ★ The embedded audio will also go silent if passing from input to output (when another audio source is not selected).

Video Output Setup

You can specify the video format and video source for the card output. If required, options are provided to adjust the output timing by adding delays.

Specifying the Output Format

You need to specify the video format for the card output.

To specify the output format for your card

1. Display the **Gator Toolbox** interface as outlined in “**Accessing the GATOR-TOOLBOX Interfaces in Dashboard**”.
- ★ If the card is operating in Dual Channel mode, double-click the tree sub-node for the Toolbox channel you want to configure. Refer to “**To display the interface for a Toolbox channel**”.
2. Select the **Config** tab.

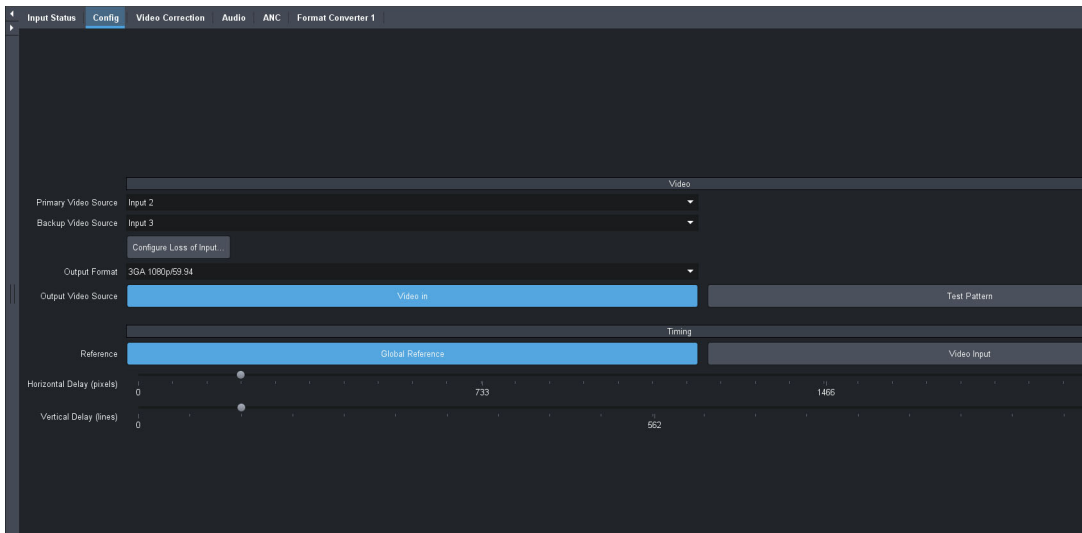

3. From the **Output Format** menu, select the video format.
- ★ The output must be compatible with the selected reference. Refer to “**Reference Setup**”.

Specifying the Output Video Source

You need to specify the video source for the output signal.

To specify the output video source for your card

1. Display the **Gator Toolbox** interface as outlined in “**Accessing the GATOR-TOOLBOX Interfaces in Dashboard**”.
- ★ If the card is operating in Dual Channel mode, double-click the tree sub-node for the Toolbox channel you want to configure. Refer to “**To display the interface for a Toolbox channel**”.
2. Select the **Config** tab.
3. Use the **Output Video Source** to specify the signal the GATOR-TOOLBOX will output. Choose from the following:
 - **Video in** — The output uses the video input signals.

- **Test Pattern** — A SMPTE bars test pattern will replace all of the output picture (but not the HANC and VANC).

Adjusting the Output Timing

You can choose to add a horizontal delay, vertical delay, or both to the output.

- ★ By default, the GATOR-TOOLBOX uses the time data reported by the MFC-OG3-N or MFC-OGX-N that is installed in the same openGear frame. This setting is displayed in the Network tab.

To adjust the timing

1. Display the **Gator Toolbox** interface as outlined in “**Accessing the GATOR-TOOLBOX Interfaces in DashBoard**”.
- ★ If the card is operating in Dual Channel mode, double-click the tree sub-node for the Toolbox channel you want to configure. Refer to “**To display the interface for a Toolbox channel**”.
2. Select the **Config** tab.
- ★ When operating in Single Channel mode, the Delay sliders in the Config tab affect all outputs. When operating in Dual Channel mode, the Delay sliders affect the outputs of the selected Toolbox channel.
3. Use the **Horizontal Delay** to specify the horizontal delay in pixels, relative to the selected reference.
4. Use the **Vertical Delay** to specify the vertical delay in lines, relative to the selected reference.

Configuring 2SI Quad Link

GATOR-TOOLBOX is compatible with multiple transport methods commonly used to carry UHD video content. In single-link mode, the GATOR-TOOLBOX can accept 11.88Gbps SDI as per SMPTE 2082-10. In Quad Link 2SI mode, the GATOR-TOOLBOX can accept quad-link 3G SDI as per SMPTE 425/5. This chapter outlines how to configure the GATOR-TOOLBOX to accept these standards.

★ This feature is not available when operating in Dual Channel mode.

Gearbox Overview

Keep the following in mind when configuring the GATOR-TOOLBOX Gearbox feature:

- The GATOR-TOOLBOX Gearbox function manages the two sample interleave (2SI) format of quad-link.
- When you enable a Gearbox input, GATOR-TOOLBOX multiplexes the signals of the four 3Gbps Level A channels together. All audio and ancillary data used for processing originates from Link 1.
- When you enable a Gearbox output, GATOR-TOOLBOX ingests a signal (either 12G UHD single-link or a 4x3Gbps 2SI quad-link) and then outputs a 4x3Gbps 2SI quad-link UHD signal. All audio and ancillary data is inserted on Link 1 except for SMPTE ST 352 which is inserted on all links.
- Input failover is not available when the GATOR-TOOLBOX Gearbox In feature is enabled.

Timing

GATOR-TOOLBOX Gearbox requires all four of the input signals be within 350ns of each other. Cable lengths to the Gearbox input should be as matched as practicable.

For More Information on...

- the cable length specifications, refer to “**Technical Specifications**”.

UHD Transport Overview

The most common application of a Gearbox is a Quad Link SDI setup at 3G per coax SMPTE ST 424. The GATOR-TOOLBOX supports the 2SI and SQD methods.

Two Sample Interleave (2SI)

The GATOR-TOOLBOX can apply the 2 Sample Interleave (2SI) method where four sub-images are used to alternate sampling every 2 pixels and every line. (**Figure 33**) This is the preferred method as it is defined in all UHDTV specifications.

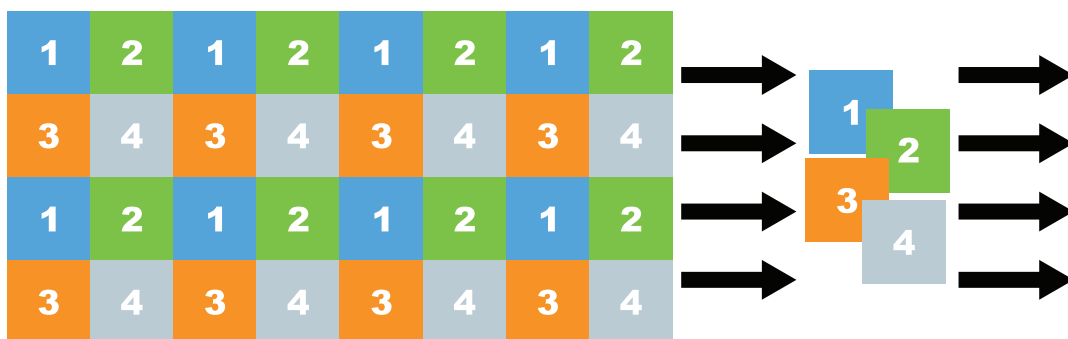

Image

Figure 33 Representation of 2SI Sampling

Input Gearbox

All audio and ancillary used for processing will originate from link 1.

Output Gearbox

When you enable the Output 2SI gearbox, the GATOR-TOOLBOX will map a UHD signal as an 3Gbps Level A output. All audio and ancillary will be inserted on link 1 except for SMPTE ST-352 which will be inserted on all links.

Configuring the GATOR-TOOLBOX for Multiplexing 2SI Quad Link

This section outlines the steps required to enable the GATOR-TOOLBOX to multiplex four 3Gbps input signals into a 12Gbps output signal.

For More Information on...

- the SDI cabling for your rear module, refer to the appropriate section in “**Supported Rear Modules**”.

To set up a physical connection between the GATOR-TOOLBOX and the external devices

1. Connect the **SDI IN** BNCs on the GATOR-TOOLBOX rear module to the device that will supply the four 3Gbps input signals to be multiplexed.
2. Connect the **SDI OUT 1** BNC on the GATOR-TOOLBOX rear module to the external device that will receive the 12Gbps signal.

To enable multiplexing of four 3Gbps inputs to a UHD Gearbox group

1. Display the **Global** interface as outlined in “**Accessing the GATOR-TOOLBOX Interfaces in DashBoard**”.
2. Select the **Setup** tab.
3. Locate the **Gearbox** area of the tab.
4. In the **Gearbox In** row click **Quad Link: 2SI**.
5. In the **Gearbox Out** row click **Single Link**.

Configuring the GATOR-TOOLBOX for De-multiplexing a 12Gbps Signal

The GATOR-TOOLBOX is capable of de-multiplexing a 12Gbps SDI sources into four separate 3Gbps SDI output signals.

For More Information on...

- the SDI cabling for your rear module, refer to the appropriate section in “**Supported Rear Modules**”.

To set up a physical connection between the GATOR-TOOLBOX and the external devices

1. Connect the **SDI IN 1** BNC on the GATOR-TOOLBOX rear module to the external device that will provide the 12Gbps signal.
2. Connect the **SDI OUT** BNCs on the GATOR-TOOLBOX rear module to the external device that will receive the four 3Gbps signals.

To assign the de-multiplexed signals to a Gearbox group

1. Display the **Global** interface as outlined in “**Accessing the GATOR-TOOLBOX Interfaces in DashBoard**”.
2. Select the **Setup** tab.
3. In the **Gearbox In** row click **Single Link**.
4. In the **Gearbox Out** row click **Quad Link: 2SI**.

Configuring the GATOR-TOOLBOX for 2SI Quad Link Inputs and Outputs

The GATOR-TOOLBOX is capable of ingesting a quad-link signal and then feeding that signal to an external device. This is especially useful for downstream equipment that require a quad-link feed.

For More Information on...

- the SDI cabling for your rear module, refer to “**Supported Rear Modules**”.

To set up a physical connection between the GATOR-TOOLBOX and the external devices

1. Connect the four **SDI IN** BNCs on the GATOR-TOOLBOX rear module to the device that will supply the quad-link signals.
2. Connect the **SDI OUT** BNCs on the GATOR-TOOLBOX rear module to the external device that will receive the quad-link signals.

To set up a quad-link input and output on the GATOR-TOOLBOX

1. Display the **Global** interface as outlined in “**Accessing the GATOR-TOOLBOX Interfaces in DashBoard**”.
2. Select the **Setup** tab.
3. In the **Gearbox In** row click **Quad Link: 2SI**.
4. In the **Gearbox Out** row click **Quad Link: 2SI**.

Configuring SQD Quad Link

There are two different ways of performing a quad link: Square Division Quad Split and 2 Sample Interleave (SI). This chapter provides information on the SQD feature of the GATOR-TOOLBOX.

★ This feature is not available when operating in Dual Channel mode.

★ Input failover is not available when the GATOR-TOOLBOX Gearbox In feature is enabled.

What is Square Division Quad Split (SQD)?

SQD is a Quad Link method introduced to produce a UHD image. Each stream contains one quarter of the original image. (Figure 34) Each quarter image is displayed at HD 1920x1080 resolution, and then quadrants are reassembled to create a full UHD image.

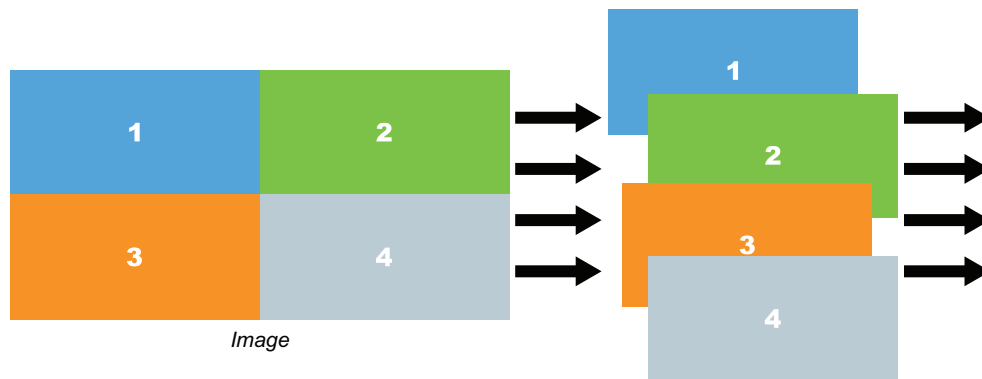

Figure 34 Representation of SQD Sampling

How does SQD differ from 2 Sample Interleave (2SI)?

In 2SI, the entire image is interleaved across the four streams, so each stream looks like a lower-resolution version of the original image. The four streams are then combined to create one 3840x2160 image.

Configuring the GATOR-TOOLBOX for Multiplexing Quad Link SQD

This section outlines the steps required to enable the GATOR-TOOLBOX to multiplex four 3Gbps SQD input signals into a 12Gbps 2SI output signal.

★ Before proceeding, ensure that you configured the Ethernet and timing settings, as well as receivers/senders for your GATOR-TOOLBOX.

For More Information on...

- the SDI cabling for your rear module, refer to “Supported Rear Modules”.

To set up a physical connection between the GATOR-TOOLBOX and the external devices

1. Connect the **SDI IN** BNCs on the GATOR-TOOLBOX rear module to the device that will supply the four 3Gbps input signals to be multiplexed.
2. Connect the **SDI OUT 1** BNC on the GATOR-TOOLBOX rear module to the external device that will receive the 12Gbps signal.

To enable multiplexing of four 3Gbps inputs to a UHD Gearbox group

1. Display the **Global** interface as outlined in “**Accessing the GATOR-TOOLBOX Interfaces in DashBoard**”.
2. Select the **Setup** tab.
3. Locate the **Gearbox** area of the tab.
4. In the **Gearbox In** row click **Quad Link: SQD**.
5. In the **Gearbox Out** row click **Single Link**.

Configuring the GATOR-TOOLBOX for De-multiplexing a 12Gbps Signal

The GATOR-TOOLBOX is capable of de-multiplexing a 12Gbps SDI sources into four separate 3Gbps SDI output signals.

For More Information on...

- the SDI cabling for your rear module, refer to “**Supported Rear Modules**”.

To set up a physical connection between the GATOR-TOOLBOX and the external devices

1. Connect the **SDI IN 1** BNC on the GATOR-TOOLBOX rear module to the external device that will provide the 12Gbps signal.
2. Connect the **SDI OUT** BNCs on the GATOR-TOOLBOX rear module to the external device that will receive the four 3Gbps signals.

To assign the de-multiplexed signals to a Gearbox group

1. Display the **Global** interface as outlined in “**Accessing the GATOR-TOOLBOX Interfaces in DashBoard**”.
2. Select the **Setup** tab.
3. In the **Gearbox In** row click **Single Link**.
4. In the **Gearbox Out** row click **Quad Link: SQD**.

★ The GATOR-TOOLBOX cannot perform SQD Gearbox on input and output simultaneously.

Configuring the GPI/Tallies

This chapter outlines how to configure each GPI/Tally independently on the GATOR-TOOLBOX.

- ★ The number of available GPIO ports depends on the rear module you are using. Refer to “**GPIO Cabling**” for cabling designations.

GPI Communication Setup

When configured as a GPI, a port behaves as an input, and can be used to trigger actions such as Cut/Dissolve the Key and/or Background. A push-button switch, or an ON-OFF switch, may be directly connected between the port and the adjacent ground pin. Alternatively, an external device may drive a low level. Minimum pulse duration is 1 ms, anything shorter will be filtered out.

Typically, users will configure the GPI for Edge trigger. This means that the action is carried out either on the falling edge (button is pushed), or rising edge (button is released), depending on which Polarity is selected. Alternatively, users may configure the GPI for Level trigger. In this mode, the action is carried out on both the rising and falling edges, so there are effectively two states. The Polarity control can be used to invert the behavior. Regardless of the trigger type, GPI commands may be overridden by other command inputs such as serial protocols.

The **Edge** options enable the GPI to act as a latching trigger. Edge triggers are used when you want to toggle between settings. This option enables the GPI to execute a specific function.

- If configured for Edge Falling, the selected function is executed when the GPI input signal transitions from High to Low.
- If configured for Edge Rising, the selected function is executed when the GPI input signal transitions from Low to High.
- Edge triggered GPI signals are sampled once per frame and the associated function is executed only once per frame. The minimum pulse width is 1 millisecond.
- Typically, the edge triggered GPI is driven by external equipment that generates one pulse per event.

Level triggers are used when you want to assert a particular state for a setting. You define the on-air state of the function as being either Level High or Level Low. Therefore, if the on-air state of the Key is defined as Level High for example, when the GPI is a Level High signal, the Key will stay on air. If a Level Low is received, the Key will be taken off air.

- If configured for Level Low, the selected function is executed when the GPI input signal is driven Low.
- If configured for Level High, the selected function is executed when the GPI input signal is driven High.

Configuring a Port as a GPI

Each port can be configured independently from the others, allowing you to customize the function of each connection.

To configure a port as a GPI

1. Display the **Global** interface as outlined in “**Accessing the GATOR-TOOLBOX Interfaces in DashBoard**”.

- ★ If the card is operating in Dual Channel mode, double-click the tree sub-node for the Toolbox channel you want to configure. Refer to “**To display the interface for a Toolbox channel**”.

2. Select the **GPI/Tally** tab.

3. If required, use the **Channel** column to specify the Toolbox channel that will control this GPI.
- ★ The **Channel** column displays on the tab when the card is operating in Dual Channel mode. Refer to “**Dual Channel Mode Setup**” for details on this mode.
4. Use the **Function** menu to assign a transition event to a specific GPI port.
5. Use the **Trigger/Tally Type** menu to select a trigger and polarity for the GPI.
6. If the **Trigger/Tally Type** is set to **Falling** or **Rising**, use the **Output Pulse Width** menu to specify the number of frames the pulse will be for an edge trigger.
7. Use the **Manual Override** and **Level** options in conjunction to override a GPI.
 - a. Select the **Manual Override** box for a GPI/Tally.
 - b. Toggle the **Level** button.
8. Select the **Enable** box for the GPI to apply the settings.

Tally Communication Setup

When configured as a Tally, a port becomes an output, providing a status indicator. Typically this is used to indicate which input(s) are on-air at any given moment. Each tally output on the card can be configured to be active when any of the inputs are on air. They can be configured as Level High or Level Low. Edge triggered tallies generate a pulse to the configure polarity (high or low) for a duration of 30 frames or the duration of the event (whichever is shorter). The tally outputs defaults to a logical high level when inactive. When the tally becomes active, for example the signal is on-air, then the output is driven low.

To configure a port as a tally

1. Display the **Global** interface as outlined in “**Accessing the GATOR-TOOLBOX Interfaces in DashBoard**”.
2. Select the **GPI/Tally** tab.
3. If required, use the **Channel** column to specify the Toolbox channel that will control this Tally.
- ★ The **Channel** column displays on the tab when the card is operating in Dual Channel mode. Refer to “**Dual Channel Mode Setup**” for details on this mode.
4. Use the **Function** menu to specify what will drive the tally output when the input is on-air.
5. Use the **Trigger/Tally Type** menu to select the polarity of the tally.
6. If the **Trigger/Tally Type** is set to **Falling** or **Rising**, use the **Output Pulse Width** menu to specify the number of frames the pulse will be for an edge trigger.
7. Use the **Manual Override** and **Level** options in conjunction to override a tally.
 - a. Select the **Manual Override** box for a GPI/Tally.
 - b. Toggle the **Level** button.
8. Select the **Enable** box for the Tally to apply the settings.

Format Converter Setup

This chapter provides instructions for configuring the Format Converter licensed feature using the menus in DashBoard.

Overview

The GATOR-TOOLBOX converts any video input format to any video output format, running at the same frame rate. A license is not required for frame rate conversion when the frame rate ratio is 1.001 or 1/1.001. For example, converting 1080p24Hz to 1080p23.98Hz does not require a license.

When the input frame rate does not match the output frame rate, the GATOR TOOLBOX+FRC license is required to enable the Format Converter options. This license enables the GATOR-TOOLBOX to perform frame rate conversion from/to 23.98Hz, 24Hz, 25Hz, 29.97Hz, 30Hz, 50Hz, 59.94Hz, and 60Hz. If the card is operating in Dual Channel mode, you will need to install a GATOR TOOLBOX+FRC license for each Toolbox channel.

For More Information on...

- enabling the GATOR TOOLBOX+FRC license, refer to “**Licensed Features**”.
- the supported formats for conversion by the GATOR-TOOLBOX, refer to “**Supported Formats for Conversion**”.

Format Converter Setup

Once the GATOR TOOLBOX+FRC license is enabled, the options on the **Format Converter** tab are editable. As part of the format conversion process, a flexible aspect ratio converter allows the video to be re-sized to a number of standard aspect ratios.

To configure the format converter settings

1. Display the **Gator Toolbox** interface as outlined in “**Accessing the GATOR-TOOLBOX Interfaces in DashBoard**”.
- ★ If the card is operating in Dual Channel mode, double-click the tree sub-node for the Toolbox channel you want to configure. Refer to “**To display the interface for a Toolbox channel**”.
2. Select the **Format Converter** tab.

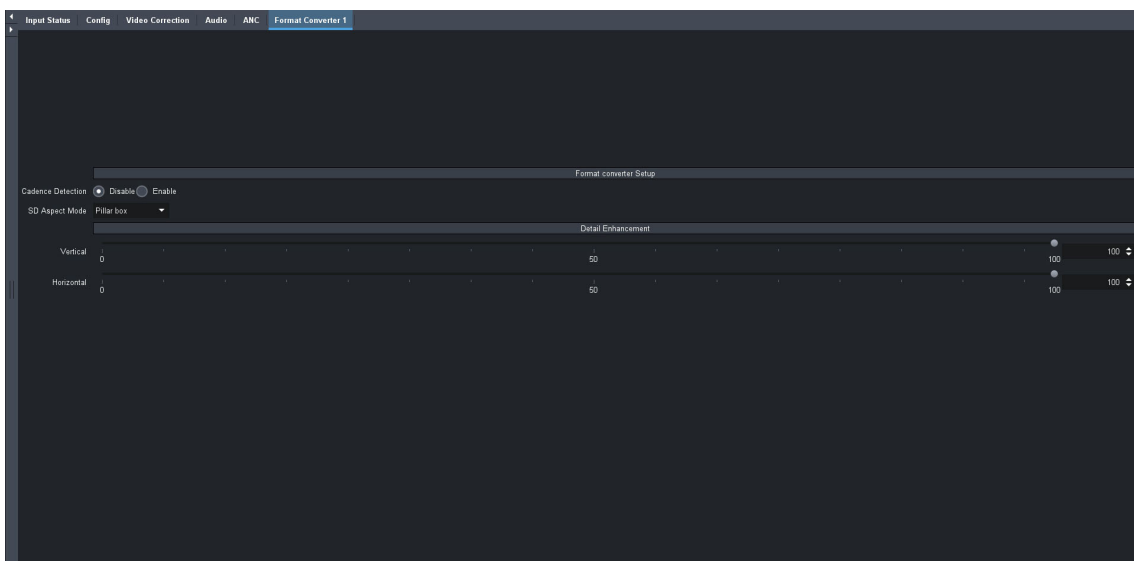

- ★ The GATOR-TOOLBOX supports up conversion from 480i 59.94Hz and 576i 50Hz. Down conversion from other formats to 480i 59.94Hz and 576i 50Hz is also available as of software version 4.1.
- 3. In the **Cadence Detection** area, select the **Enable** box.
If the input is detected with the proper cadence, the GATOR-TOOLBOX will allow conversion from 23.98/24Hz formats.
- 4. If you are up/down converting from/to 480i 59.94Hz or 576i 50Hz, use the **SD Aspect Mode** options to determine how the video is re-sized to a chosen aspect ratio. Choose from the following:
 - **Full screen** — select this option when the original SD input is 16:9 aspect ratio and you are up converting to 16:9 HD/3G/6G/12G.
 - **Pillar box** — select this option when performing an 4:3 SD to 16:9 HD/3G/6G/12G up-conversion.
 - **Letter box** — select this option when performing an 16:9 HD/3G/6G/12G to 4:3 SD down-conversion.
- 5. If you are converting any HD or 3G source to any output format (including 2160p outputs), use the **Vertical Detail Enhancement** and **Horizontal Detail Enhancement** sliders to adjust the filtering during conversion.
- ★ The sliders are ignored when format conversion is not required (the input format matches the output format). The video input signal is passed without modification.
- 6. If you are operating in Dual Channel mode, and have installed an GATOR TOOLBOX+FRC license for each Toolbox channel, repeat steps 2 to 5 for the second Toolbox channel.

SDR/HDR Conversion

This chapter provides information on the SDR/HDR conversion features of the GATOR-TOOLBOX.

For More Information on...

- enabling the GATOR TOOLBOX+HDR-LUT license, refer to “**Installing a License Key**”.

Overview

The GATOR-TOOLBOX provides the following SDR/HDR conversion features as standard:

- Built-in HDR/SDR conversion
- Selectable Tone Mapping modes
- SDI output Y/C clipper to pass/clip extended super-black or super-white ranges
- RGB Color Correction

The GATOR TOOLBOX+HDR-LUT license is required for the following features:

- Independent ProcAmp controls for the video input and for the video output
- SDI output Y/C clipper to pass/clip extended super-black or super-white ranges
- SDR/HDR transfer characteristic and colorimetry information inserted into the SDI video output 352M payload identifier
- Import and apply 3D-LUT RGB Cube files
- Access the NBCU and BBC 3D-LUT libraries (pre-loaded RGB LUT files)

The following sub-sections outline specific features of the GATOR TOOLBOX+HDR-LUT license.

- ★ If the card is operating in Dual Channel mode, you will need to install a GATOR TOOLBOX+HDR-LUT license for each Toolbox channel.

Built-in SDR/HDR Conversion

The GATOR-TOOLBOX supports dynamic range and colorimetry/transfer characteristics conversion from/to any of these standards:

- BT.709 SDR
- BT.2020 SDR
- BT.2020 HLG
- BT.2020 PQ
- BT.2020 S-Log3
- BT.2020 SR Live

The video input dynamic range and colorimetry/transfer characteristics settings can be manually configured or can be automatically detected from the SDI video input 352M payload identifier.

The video output dynamic range and colorimetry/transfer characteristics settings can be manually configured or can be automatically set to follow the SDI video input dynamic range and colorimetry/transfer characteristics.

The SDR/HDR conversion also offers the following options:

- Display light or scene light conversion
- Direct mapping or tone (up/down) mapping
- RGB Color Correction with adjustment controls for gamma, lift, gain, and offset

SDR/HDR Conversion with 3D-LUT RGB Cube Files

The GATOR-TOOLBOX also supports SDR/HDR conversion with a 33x33x33 3D-LUT RGB cube files including:

- BT.709 and BT.2020 colorimetry/transfer characteristics for Y/C RGB conversion
- Preloaded 3D-LUT RGB Cube files library from BBC and NBCU
- Ability to load 33x33x33 3D-LUT RGB Cube files to perform custom conversions
- Support for Narrow Range (Type I) and Full Range (Type III) 3D-LUT RGB Cube files

Accessing the SDR/HDR Conversion Settings

The SDR/HDR conversion settings are accessed via the DashBoard **Video Correction** tab.

To display the SDR/HDR Conversion tab

1. Display the **Gator Toolbox** interface as outlined in “**Accessing the GATOR-TOOLBOX Interfaces in Dashboard**”.
- ★ If the card is operating in Dual Channel mode, double-click the tree sub-node for the Toolbox channel you want to configure. Refer to “**To display the interface for a Toolbox channel**”.
2. Select the **Video Correction** tab.

The **SDR/HDR Conversion** sub-tab is automatically selected.

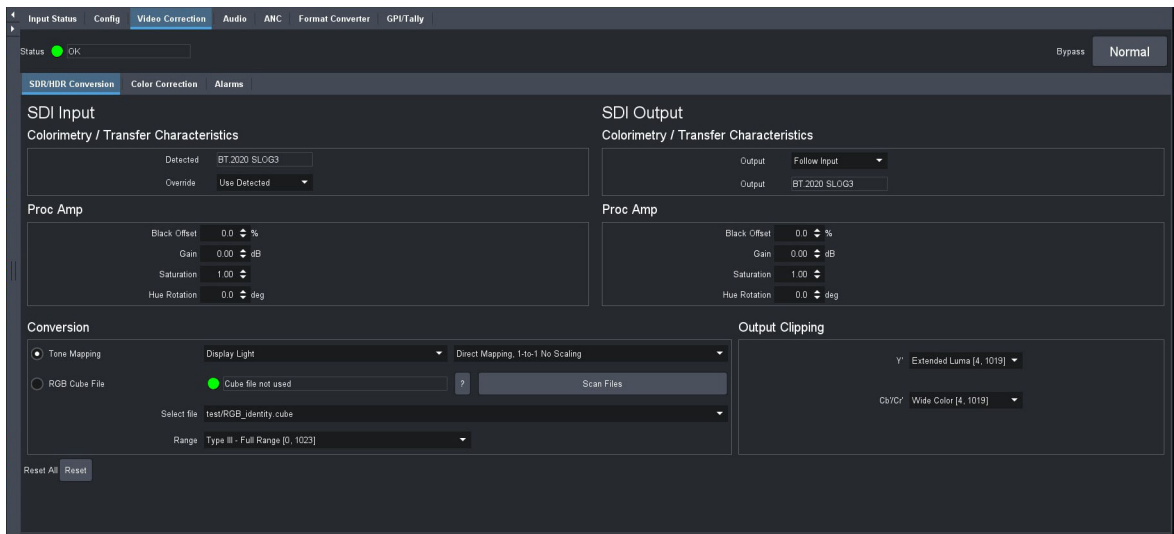

Bypassing the Video Correction Settings

You can choose to bypass the video correction setting by clicking **Normal** (located in the top right corner of the Video Correction tab). Note that Normal is the default state of this button.

When clicked, the button is lit red and the label changes to **Bypass**. (Figure 35)

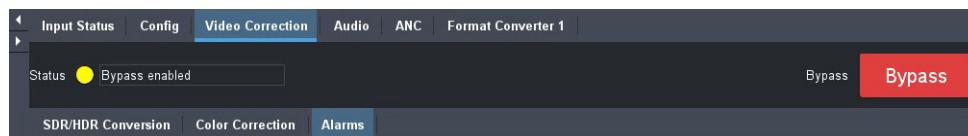

Figure 35 Example of Bypassing the Video Correction Settings

When this button displays the label **Normal**, the GATOR-TOOLBOX is processing the video input through the ProcAmps, the SDR/HDR converter, and the RGB Color Corrector and performing the target transform.

When this button displays the label **Bypass**, the GATOR-TOOLBOX is passing through the video input without modifications. Refer to “**Bypass Alarm**” for more details.

Dynamic Range and Colorimetry/Transfer Characteristics Setup

The GATOR-TOOLBOX performs the SDR/HDR dynamic range and colorimetry/transfer characteristics conversion as specified in the **SDI Input** and **SDI Output** areas of the Video Corrections tab. (**Figure 36** and **Figure 37**).

The default SDI Input > Colorimetry/Transfer Characteristics > Override > User Detected setting automatically extracts the dynamic range and colorimetry information from the SDI video input 352M payload identifier and adjusts the SDR/HDR conversion accordingly.

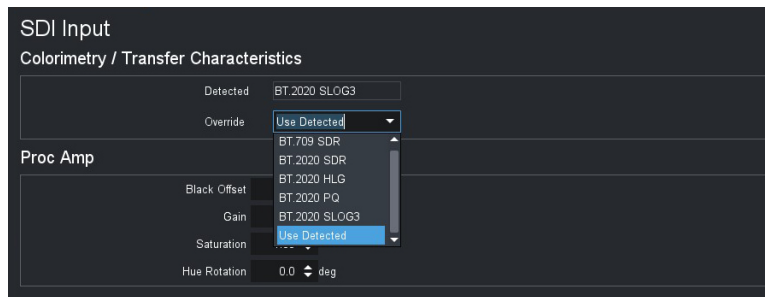

Figure 36 Example of the Video Correction > SDI Input Area

The default SDI Output > Colorimetry/Transfer Characteristics > Output > Follow Input setting automatically follows the dynamic range and colorimetry information as defined in the SDI Input area. In that case no SDR/HDR conversion is performed but the other video processing featured such as the ProcAmps and the RGB Color Correction are still available.

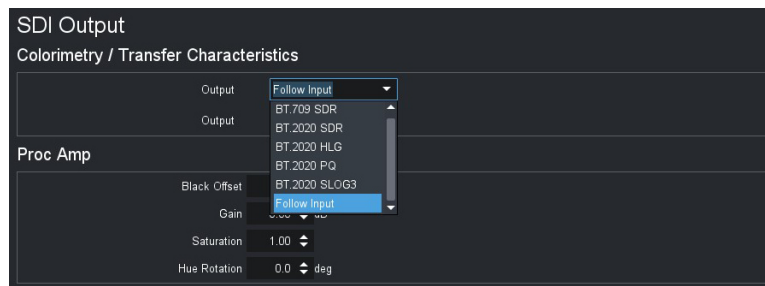

Figure 37 Example of the Video Correction > SDI Output Area

The other options are common to both the **SDI Input** and the **SDI Output** and are used to force a specific SDR/HDR conversion. The following common options are available:

- BT.709 SDR — HD colorimetry/transfer characteristics, Standard Dynamic Range
- BT.2020 SDR — UHD wide colorimetry/transfer characteristics, Standard Dynamic Range
- BT.2020 HLG — UHD wide colorimetry/transfer characteristics, Hybrid Log-Gamma dynamic range
- BT.2020 PQ — UHD wide colorimetry/transfer characteristics, Perceptual Quantizer dynamic range
- BT.2020 S-LOG3 — UHD wide colorimetry/transfer characteristics, Sony ® S-Log3 dynamic range
- BT.2020 SR Live — UHD wide colorimetry/transfer characteristics recommended for UHDTV1 video signals, Sony® standard range

- ★ An alarm is generated if the dynamic range and colorimetry information extracted from the SDI video input 352M payload identifier does not match the specific SDR/HDR conversion as defined by the user.

Proc Amps Setup

The GATOR-TOOLBOX offers two independent Proc Amps. The **Input Proc Amp** is located upstream of the SDR/HDR conversion and the **Output Proc Amp** is located downstream of the SDR/HDR conversion. Both Proc Amps offer the same controls. (Figure 38)

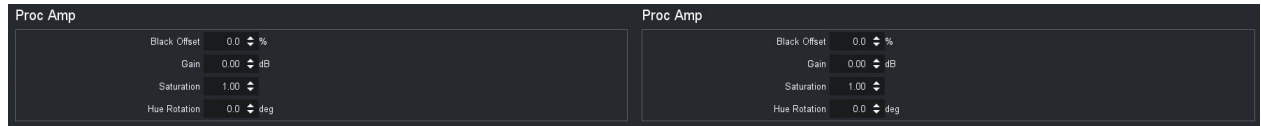

Figure 38 Example of the Input (right) and Output (left) Proc Amps

Black Offset

This control adjusts the Luma (Y) black offset of the SDI input or output streams. The value is reported as a percentage of the full black to white signal amplitude with an adjustment range from -20% to +20%, in steps of 0.1%.

- ★ The black offset adjustment is applied before the gain adjustment.

Gain

This control adjusts the Luma and Chroma (Y/C) gain of the SDI input or output streams. The value is reported in dB with an adjustment range from -20dB to +20dB, in steps of 0.01dB.

- ★ The gain adjustment is applied after the user's black offset adjustment.

Saturation

This control adjusts the brightness level of the SDI input or output color. The adjustment range is from 0dB to 2.0dB.

Hue Rotation

This control adjusts the hue level. Increasing the hue rotation turns the color wheel clockwise, and decreasing the hue rotation turns the color wheel counter-clockwise. The adjustment range is from -180 to +180.

- ★ The Hue Rotation setting is disabled and ignored when an RGB Cube file is in use.

Built-In SDR/HDR Conversion Setup

The GATOR-TOOLBOX features a built-in SDR/HDR Conversion engine, calculating on-the-fly the conversion specified in the **SDI Input** and **SDI Output** areas, and loading the internal 33x33x33 3D-LUT tetrahedral interpolator hardware with the calculated transform. The built-in SDR/HDR Conversion engine is enabled when the **Tone Mapping** option is selected in the **Conversion** area. (Figure 39)

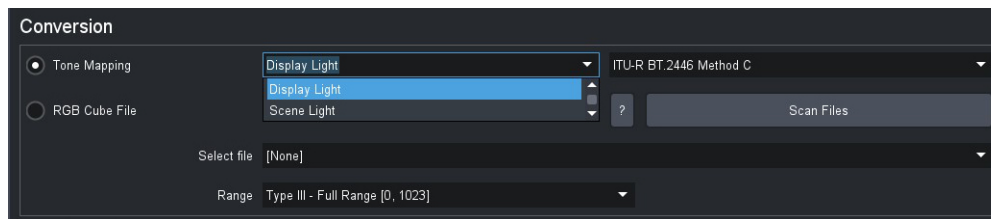

Figure 39 Example of the Tone Mapping Settings

Selecting a Tone Mapping Conversion Option

The Tone Mapping feature provides two SDR/HDR conversion light options: Display Light or Scene Light.

Display Light

The common reference for the transform is the visible light as emitted by a display monitor. When set to Display Light conversion, the GATOR-TOOLBOX:

1. Uses the EOTF of the SDI input dynamic range and colorimetry/transfer characteristics to convert the SDI input electrical signal to the Display Light units.
2. Uses the inverse EOTF of the SDI output dynamic range and colorimetry/transfer characteristics to convert the Display Light units to the SDI output electrical signal.

Scene Light

The common reference for the transform is the visible light as diffused by the ambient scene. When set to Scene Light conversion, the GATOR-TOOLBOX:

1. Uses the inverse EOTF of the SDI input dynamic range and colorimetry/transfer characteristics to convert the SDI input electrical signal to Scene Light units.
2. Uses the EOTF of the SDI output dynamic range and colorimetry/transfer characteristics to convert the Scene Light units to the SDI output electrical signal.

Selecting a Conversion Mapping Option

The GATOR-TOOLBOX built-in SDR/HDR conversion mapping options are:

- Direct Mapping, 1-to-1 No Scaling
- Direct Mapping, BT.2408 Scaling

Direct Mapping, 1-to-1 No Scaling

This Direct Mapping option performs a straight conversion, without dynamic range compression or expansion, and without colorimetry/transfer characteristics compression or expansion. This means that when a HDR input stream is converted to an SDR output stream, all HDR source pixels that are outside the output SDR dynamic range or colorimetry/transfer characteristics will be clipped, losing luminance and/or color information.

Direct Mapping, BT.2408 Scaling

This Direct Mapping option performs a conversion as defined in *ITU-BT.2408*.

SDR/HDR Conversion with 3D-LUT RGB Cube Files

The GATOR-TOOLBOX SDR/HDR built-in conversion engine offers limited tone mapping and inverse tone mapping options. To expand the capability of the GATOR-TOOLBOX, Ross Video offers a set of

pre-loaded 3D-LUT RGB cube files, each one designed to meet specific conversion requirements. It is also possible for the user to load custom 33x33x33 3D-LUT RGB cube files for specific applications.

When the user configures the GATOR-TOOLBOX to perform the SDR/HDR conversion using a 3D-LUT RGB cube file, then the proprietary SDR/HDR transform is natively programmed into the 3D-LUT file. In that case, the user still needs to configure correctly the Dashboard **SDI Input** and the **SDI Output** options as the BT.709 or BT.2020 colorimetry information are required by the GATOR-TOOLBOX to:

- convert the Y/C to RGB values,
- drive the RGB 3D-LUT input, and then
- convert the RGB 3D-LUT output back to Y/C.

Loading a 3D-LUT RGB Cube File

The Dashboard **RGB Cube File** option allows to select and load one RGB Cube file stored locally on the GATOR-TOOLBOX.

The **Scan Files** button will read and list all the files found in the root directory and in the sub-directories, listing all the pre-loaded BBC and NBCU cube files libraries and any custom cube files already loaded by the user. Selecting one cube file from the list will automatically load and apply it.

- ★ Loading a **RGB Cube File** disables the Dashboard **Tone Mapping** options Display/Scene light and Direct/Tone Mapping Methods, and the Proc Amps > Hue Rotation setting.

Specifying the 3D-LUT RGB Cube File Type

A 3D-LUT Cube File is designed to process a specific input/output signal range. The Dashboard option **Range** provides two processing signal ranges:

- Type I – Normal Range [64,940]
- Type III – Full Range [0,1023]

- ★ The pre-loaded 3D-LUT RGB cube files library, most BBC cube files, and all NBCU cube files are of Type III.

The **Type I Normal Range** scales the SDI input signal level [64,940] to drive the 3D-LUT input processing range [0,1023] and will scale the 3D-LUT output processing range [0,1023] back to the SDI output signal level [64,940]. This means that a **Type I** 3D-LUT Cube file will clip super-blacks or super-whites on the SDI input and will not be able to generate super-blacks or super-whites on the SDI output.

The **Type III Full Range** will drive the full 10-bit SDI input signal level directly to the 3D-LUT input processing range [0,1023] and will scale the 3D-LUT output processing range [0,1023] to the SDI output signal level [0,1023]. This means that a Type III 3D-LUT Cube file will be able to process super-blacks and super-whites on the SDI input and will be able to generate super-blacks and super-whites on the SDI output.

- ★ To allow super-blacks or super-whites on the SDI video output stream, the **Video Output Clipping** option must be set to the **Extended Luma [4,1019]** range.

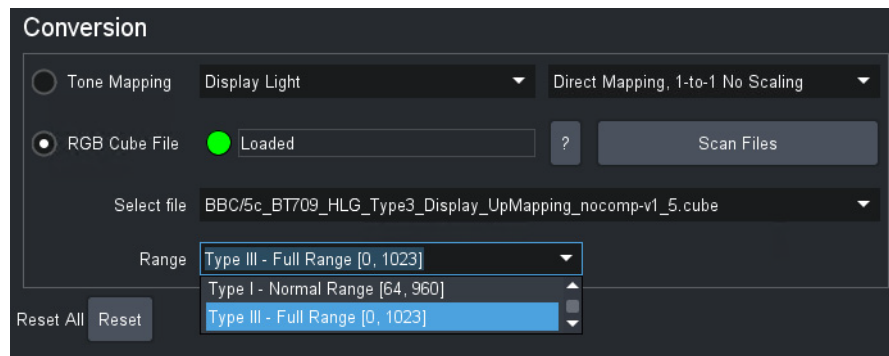

Figure 40 Example of Selecting a Range for the RGB Cube File

As described above, the functionality of the **Type I Normal Range** 3D-LUT RGB Cube File is a subset of the functionality of the **Type III Full Range**. For that reason, most applications will be using the **Type III Full Range** 3D-LUT RGB Cube File.

Pre-Loaded RGB Cube Files Library

With the GATOR TOOLBOX+HDR-LUT license, the GATOR-TOOLBOX provides a library of pre-loaded 3D-LUT RGB cube files from the BBC and NBCU.

3D-LUT RGB Cube Files from BBC

These 3D-LUT files are designed and copyrighted by the BBC and are available under license. A sub-set of the BBC 3D-LUT files are pre-loaded in the GATOR-TOOLBOX as part of the GATOR TOOLBOX+HDR-LUT license. Refer to **Table 7** for details on the available files.

Table 7 Pre-loaded 3D-LUT RGB Cube Files — BBC

BBC LUT #	Conversion and Filename Info
1	BT.2100 PQ 1000 cd/m ² to BT.2100 HLG, Type III File: BBC/ 1e_PQ1000_HLG_Type3_Transcode_nocomp-v1_7.cube
2	BT.2100 PQ 4000 cd/m ² to BT.2100 HLG, Type III File: BBC/ 2e_PQ4000_HLG_Type3_Transcode_nocomp-v1_7.cube
3	BT.709 SDR to BT.2100 HLG direct-mapping, Type I, display-light File: BBC/ 3a_BT709_HLG_Type1_Display_DirectMapping_nocomp-v1_7.cube
	BT.709 SDR to BT.2100 HLG direct-mapping, Type III, display-light File: BBC/ 3c_BT709_HLG_Type3_Display_DirectMapping_nocomp-v1_7.cube
4	BT.709 SDR to BT.2100 HLG direct-mapping, Type III, scene-light File: BBC/ 4-1a_BT709_HLG_Type3_Scene_DirectMapping_nocomp-v1_7.cube
5	BT.709 SDR to BT.2100 HLG up-mapping, Type III, display-light File: BBC/ 5c_BT709_HLG_Type3_Display_UpMapping_nocomp-v1_7.cube
6	BT.709 SDR to BT.2100 HLG up-mapping, Type III, scene-light File: 6-1a_BT709_HLG_Type3_Scene_UpMapping_nocomp-v1_7.cube
7	BT.2100 HLG to BT.2100 PQ 1000 cd/m ² , Type III File: BBC/ 7c_HLG_PQ1000_Type3_Transcode_nocomp-v1_7.cube
8c	BT.2100 HLG to BT.709 SDR down-mapping, Type III, display-light File: HLG_BT709_Type3_Display_DownMapping_CAM_nocomp-v1_7.cube
9	BT.2100 HLG to BT.709 SDR down-mapping, Type III, display-light, with SDR super-whites File: BBC/ 9c_HLG_BT709_Type3_Display_DownMapping_SuperWhite_nocomp-v1_7.cube

Table 7 Pre-loaded 3D-LUT RGB Cube Files — BBC (Continued)

BBC LUT #	Conversion and Filename Info
10	BT.2020 S-Log3 to BT.2100 HLG, Type II, scene-light (use Dashboard Type III option) File: BBC/ 10a_S-Log3-100pc_HLG_Type2_Scene_Transcode_nocomp-v1_7.cube
11	“SR Live” S-Log3 to BT.2100 HLG, Type II, scene-light (use Dashboard Type III option) File: BBC/ 11a_S-Log3-200pc_HLG_Type2_Scene_Transcode_nocomp-v1_7.cube
17	BT.2020 SDR to BT.2100 HLG direct-mapping, Type III, display-light, graded content File: BBC/ 17c_BT2020_HLG_Type3_Display_DirectMapping_nocomp-v1_7.cube
18	BT.2020 SDR to BT.2100 HLG up-mapping, Type III, display-light, graded content File: BBC/ 18c_BT2020_HLG_Type3_Display_UpMapping_nocomp-v1_7.cube
19	BT.2100 HLG to BT.2100 HLG Traditional Camera Look, Type III File: BBC/ 19c_HLG_Camera_to_TraditionalLook_Type3_Conversion_nocomp-v1_7.cube

3D-LUT RGB Cube Files from NBCU

These 3D-LUT files are designed and copyrighted by the NBC Universal (NBCU) and are publicly available free of use. A sub-set of the NBCU 3D-LUT files are pre-loaded in the GATOR-TOOLBOX as part of the GATOR TOOLBOX+HDR-LUT license. Refer to **Table 8** for details on the available files.

Table 8 Pre-loaded 3D-LUT RGB Cube Files — NBCU

NBCU LUT #	Conversion and Filename Info
1	BT.709 SDR to BT.2100 HLG, Type III, display-light, direct-mapping File: NBC/ 1-NBCU_SDR2HLG_DL_v1.1.cube
2	BT.709 SDR to BT.2100 HLG, Type III, display-light, up-mapping File: NBC/ 2-NBCU_SDR2HLG_SL_v1.cube
3	BT.2100 HLG to BT.709 SDR, Type III, display-light, down-mapping File: NBC/ 3-NBCU_HLG2SDR_DL_v1.1.cube
4	BT.709 SDR to BT.2100 PQ, Type III, display-light, up-mapping File: NBC/ 4-NBCU_SDR2PQ_DL_v1.cube
5	BT.2100 PQ to BT.709 SDR, Type III, display-light, down-mapping File: NBC/ 5-NBCU_PQ2SDR_DL_v1.cube
7	BT.2100 HLG 1000 cd/m ² to BT.2100 PQ, Type III, display-light File: NBC/ 7-NBCU-HLG2PQ_1000nit_v1.cube

Loading Custom RGB Cube Files

The GATOR TOOLBOX+HDR-LUT license also offers the possibility of loading third-party or custom made 33x33x33 RGB Cube files directly into the GATOR-TOOLBOX local directory. Once loaded, the files are saved internally in non-volatile storage and can be recalled anytime to fulfill the requirements of specific SDR/HDR conversions.

3D-LUT Cube File Format

The three-dimensional RGB Cube file is a text file following the format defined in the **Cube LUT Specification Version 1.0** document from Adobe Systems Inc. The GATOR-TOOLBOX product supports only the 33x33x33 three-dimensional table LUT data. In other words, the file must have the keyword “LUT_3D_SIZE” set to **33**.

No Matrix Compensation

The GATOR-TOOLBOX does not require 3D-LUT Cube files with matrix compensation as this product has all the build-in hardware to do the BT.709 or BT.2020 colorimetry/transfer characteristics conversion on the SDI video input and on the SDI video output. You must then select and use only the third-party 3D-LUT Cube files that were created “Without Compensation Matrix”.

Conversion Types I, II, and III

When browsing into third-party offering of 3D-LUT Cube files library, you will often encounter the option for conversions Type I, Type II and Type III. The Type III 3D-LUT Cube Files are the recommended type to be used with the GATOR-TOOLBOX product.

- **Type I** — intended for software applications and older hardware-LUT devices that operate over the nominal SDI signal range [64,940]. They do not process super-blacks or super-whites. The GATOR-TOOLBOX has the option to support these files but it is recommended the use the Type III 3D-LUT Cube Files if possible.
- **Type II** — intended for SDI input signals that require full-range processing, like Sony's S-Log3. The GATOR-TOOLBOX does not support the Type II 3D-LUT Cube files.
- **Type III** — intended for hardware 3D-LUT devices that process narrow-range SDI signal [64,940], but operate over the full 10-bit signal range [0,1023]. These files offer the headroom to process super-blacks and super-whites without clipping. The Type III 3D-LUT Cube Files are the recommended type to be used with the GATOR-TOOLBOX product.

Loading a 3D-LUT Cube File to the GATOR-TOOLBOX

The 3D-LUT cube files are transferred to and from the GATOR-TOOLBOX using FTP protocol. The files are stored on the Micro SD card that is installed on the GATOR-TOOLBOX. You must load the files to the Micro SD card, before importing to the GATOR-TOOLBOX Video Correctors.

- ★ When using Mac OS X™ to transfer files to the Micro SD card via an FTP server, you may only have read-only access. Refer to your Mac OS X™ documentation for details.

Keep the following in mind before loading your 3D-LUT files:

- The directory for your 3D-LUT files must be only 1 folder deep.
- The filename must include the 3D-LUT file extension.

Connection using FTP

You can use an FTP connection to transfer 3D-LUT files to and from the Micro SD card of the GATOR-TOOLBOX. You can also use an FTP client to delete files on the Micro SD card.

Before accessing the GATOR-TOOLBOX via FTP:

1. Ensure the GATOR-TOOLBOX link status is valid. This information is reported in the Global > Network > Link Status field in Dashboard.
2. The default login credentials are:
 - User Name — user
 - Password — password

Using the Micro SD Card

The following tips and restrictions apply when using the Micro SD card:

- the GATOR-TOOLBOX must be powered down to install or remove the Micro SD card.
- if you must remove the Micro SD card for programming, re-boot the GATOR-TOOLBOX when you re-install the Micro SD card. This allows the GATOR-TOOLBOX to recognize that a new card is available.

SDI Video Output Clipping Setup

The GATOR-TOOLBOX provides the options to enable or clip super-blacks and super-whites on the SDI video output Luma (Y') stream. Super-blacks are often found in common color bar test patterns such as the ITU-R BT.814 HDR PLUGE and others. Super-whites may be created when down converting HDR to SDR, where the HDR highlights will be mapped in the 100% to 109% SDR super-white range. Super-blacks and super-whites can also be created with the ProcAmp gain and offset controls.

Figure 41 shows the Output Clipping > Y' settings.

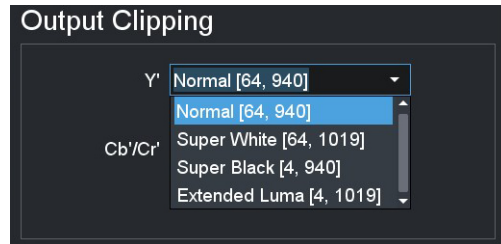

Figure 41 Example of Video Correction > SDR/HDR Conversion > Output Clipping

- ★ An option to allow extended Chroma (Cb'/Cr') is also available but will rarely be used in practice to maintain interoperability with other equipment.

RGB Color Correction

This section outlines the controls that the GATOR-TOOLBOX provides to perform basic RGB color correction.

- ★ The **Color Correction** functions are not available when the user selects to perform an SDR/HDR conversion with an 3D-LUT RGB Cube file. Refer to **“SDR/HDR Conversion with 3D-LUT RGB Cube Files”** for details.

Overview

Under the DashBoard **Video Correction** tab, the **Color Correction** sub-tab provides several controls to perform basic RGB color correction functions. (**Figure 42**)

To display the Color Correction tab

1. Display the **Gator Toolbox** interface as outlined in **“Accessing the GATOR-TOOLBOX Interfaces in DashBoard”**.
- ★ If the card is operating in Dual Channel mode, double-click the tree sub-node for the Toolbox channel you want to configure. Refer to **“To display the interface for a Toolbox channel”**.
2. Select the **Video Correction** tab.
3. Select the **Color Correction** sub-tab.

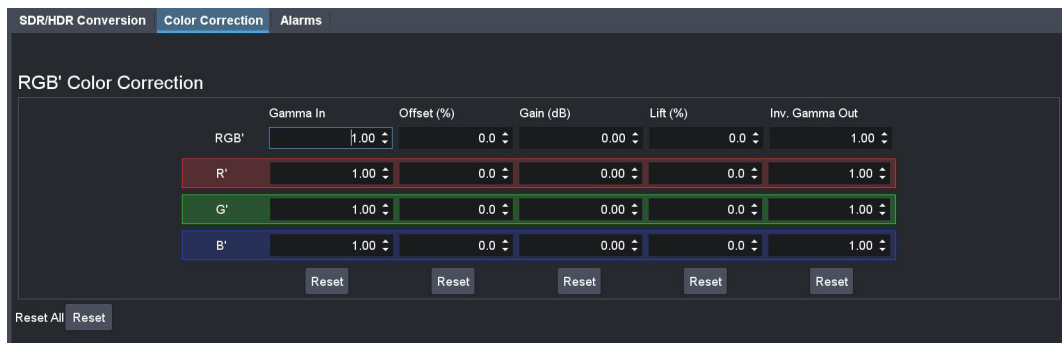

Figure 42 Example of the Video Correction > Color Correction Options

Controls are available for the grouped RGB' and for individual R', G', and B' components. (Figure 42) The color correction processing is performed downstream of the SDR/HDR 3D-LUT conversion engine, and as indicated by the prime symbol, in the nonlinearly coded (gamma-corrected) components of the video output.

The RGB Color Corrector processing functions are cumulative and are executed in this sequence:

1. **Gamma In** — applies a Gamma function to the RGB' stream.
2. **Black Offset** — adjusts the black offset of the RGB' stream. The unit is in percentage of the full black to white signal amplitude with an adjustment range from -20% to +20%, in steps of 0.1%.
3. **Gain** — adjusts the gain of the RGB' stream. The unit is in dB with an adjustment range from -20dB to +20dB, in steps of 0.01 dB.
4. **Black Lift** — lifts the black level of the RGB' stream, while applying a gain to keep the peak white at the same level. The unit is in percentage of the full black to white signal amplitude with an adjustment range from -20% to +20%, in steps of 0.1%.
5. **Gamma Out** — applies an inverse Gamma function to the RGB' stream.

Monitoring the Color Conversion

Under the DashBoard **Video Correction** tab, the **Alarms** sub-tab has three options to enable or disable alarm notifications related to color conversion.(Figure 43) In all cases, the alarm event information is always reported inside the top left Status text box, only the green indicator will turn yellow if the alarm is enabled.

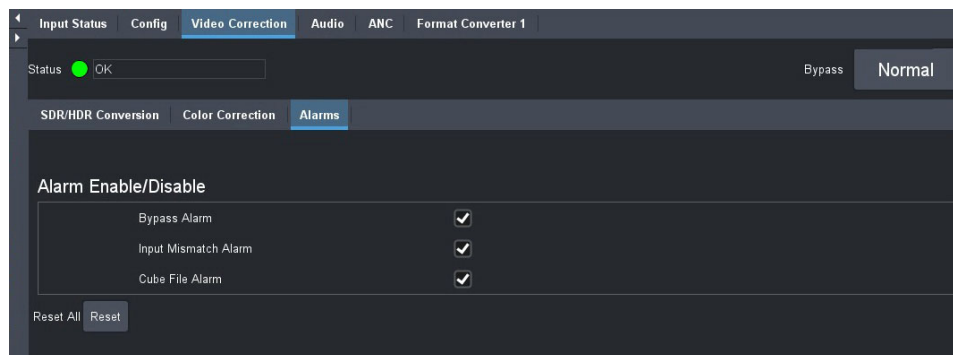

Figure 43 Example of the Video Correction > Alarms Options

Bypass Alarm

When enabled, this option will raise a DashBoard alarm notification whenever the Video Correction is bypassed. As a reminder, all the Video Correction settings are bypassed after the top-right button is clicked and is then lit red and labeled **Bypass**. (Figure 44)



Figure 44 Example of Bypassing the Video Correction Settings

Input Mismatch Alarm

When enabled, this option will raise a DashBoard alarm notification whenever the SDR/HDR dynamic range and the BT.709 / BT.2020 colorimetry information decoded in the SDI video input 352M payload identifier does not match the option selected in the SDI Input area of the Video Correction > SDR/HDR Conversion sub-tab.

Cube File Alarm

When enabled, this option will raise a DashBoard alarm notification whenever there was a problem loading the user specified 33x33x33 3D-LUT RGB Cube File. The most common error condition will simply be that there is no file specified by the user, that the Select File option is set to the default [None] in the Video Correction > SDR/HDR Conversion sub-tab.

Ancillary Data

Ancillary Data (ANC) is the non-video data that can be embedded within the SDI signal, such as audio, audio metadata, timecode, closed caption data, AFD, and payload identification. This chapter provides an overview of ANC processing for the GATOR-TOOLBOX.

★ This chapter assumes the GATOR-TOOLBOX interface displays in the DashBoard window as outlined in “**Accessing the GATOR-TOOLBOX Interfaces in DashBoard**”.

Overview

There are two areas in which ancillary data may be found:

- **HANC** — ANC packets that are found in the horizontal blanking region.
- **VANC** — ANC packets that are found in the vertical blanking region.

This section outlines how to view incoming status in the **Input Status** tab and configure the GATOR-TOOLBOX to manage HANC and VANC data using the options in the **ANC** tab of DashBoard.

HANC and VANC Status

The **Input Status** tab in DashBoard provides HANC and VANC status details:

- **Embedded Audio** — These fields indicate the information extracted from the channel status, such as PCM/Non-PCM, 20bit or 24bit. If there is PCM data, a level in dB is also displayed. When this field is blank, the packet for the specified group is absent. Refer to **Table 25** for status message details.
- **ST 352 Upstream** — This field indicates whether the 352M data is detected on the input, and displays the four bytes.
- **AFD, Closed Captioning, Timecode, Compressed Audio Metadata, SCTE-104, Other** — These fields indicate the status of the specified packet, such as whether it is detected or not on the input.

Where each message includes the following information:

- › **Field #** — indicates which field the timecode was detected in (e.g. Field 1 (Odd))
- › **Type** — indicates the type of timecode (e.g. ATC-VITC1)
- › **Line #** — indicates the specific line the timecode data was detected in (e.g. 16)
- › **Location** — indicates timecode is in the HANC (H), or VANC (<blank>)
- › **Channel** — indicates timecode is in the luma (L), or chroma (C) channel

CEA-708/CEA-608 Closed Captioning

When disabled, closed captioning (packet and line 21) is not inserted. Otherwise, this section summarizes the closed caption processing of the card.

The GATOR-TOOLBOX card:

- ensures continuity of CEA-608 data and/or DTVCC data during frame drop or repeat.
- receives the packet, processes it, and inserts a new packet into the specific line.
- monitors the CDP sequence number of incoming CEA-708 data to detect discontinuities in the DTVCC transport stream, and propagates any sequence-number discontinuity to the outgoing DTVCC data, to alert downstream equipment of the change.

Captioning Priority

There are two supported types of closed captioning data: native CEA-708, and CEA-608 embedded in CEA-708. The order of preference for output CEA-708 data is as follows:

1. CEA-708
2. Up-converted CEA-608 embedded in CEA-708

The order of preference for output CEA-608 data is as follows:

1. CEA-608 embedded in CEA-708
2. Null content

★ CEA-708 is not down-converted to CEA-608.

The card decodes any CEA-708 caption distribution packets (CDP) from the input video and embeds the same data in the output video. The CDP is re-formatted as required based on the frame rate, to maintain the correct CEA-708 transport channel data rate (9600bps) as specified by SMPTE 334-2. The GATOR-TOOLBOX ignores any timecode information in the CDP. If there is no native CEA-708, then CEA-608 is translated to native CEA-708 DTVCC format, and embedded along with the original CEA-608 data in the output CDPs.

- CC1 is translated and encoded as DTVCC Service #1.
- CC3 is translated and encoded as DTVCC Service #2.
- CC2 and CC4 are not translated.
- such translation follows **CEA-708-C section 8.11** and supports the standard character sets described in **CEA-608-D section 6.4.1**.

Other Data Types

This section provides additional information on other data types that the GATOR-TOOLBOX series manages.

Timecode

The user can specify whether timecode is passed or disabled:

- If the input is not synchronous to the output, select **Disable** from the **Action** menu of the **ANC** tab.
- If converting between progressive and interlaced, select **Disable** from the **Action** menu of the **ANC** tab.
- When pass is enabled, the timecode will be inserted in VANC (RP208) for SD outputs, and HANC (RP196) for all other formats.
- If the input is not synchronous to the output, data will be dropped (but not duplicated¹) as part of the frame sync behavior.

1. When a frame of video is duplicated, no packet is inserted in the duplicate frame.

Compressed Audio Metadata

Compressed Audio Metadata can be passed or disabled as follows:

- If the input is not synchronous to the output, select **Disable** from the **Action** menu of the **ANC** tab.
- If converting between progressive and interlaced formats, select **Disable** from the **Action** menu of the **ANC** tab.
- If the input is not synchronous to the output, data will be dropped (but not duplicated¹) as part of the frame sync behavior.

Other Packets

All remaining packets can be passed or disabled. When pass is enabled, the packets will be inserted in VANC on the specified line in the same order as they were received. If they do not fit on the specified line, they will continue on the next line. Approximately up to 250 packets, or 1500 bytes of data, can be passed this way. If the input is not synchronous to the output, data will be dropped (but not duplicated¹) as part of the frame sync behavior.

Specific ANC Processing

The **ANC** tab controls how ancillary data is inserted in the output when HANC and/or VANC pass through is not enabled.

ANC Processing Overview

For each packet type the user can control the insertion position.

To configure the processing of specific ANC types

1. Display the **Gator Toolbox** interface as outlined in “**Accessing the GATOR-TOOLBOX Interfaces in Dashboard**”.
- ★ If the card is operating in Dual Channel mode, double-click the tree sub-node for the Toolbox channel you want to configure. Refer to “**To display the interface for a Toolbox channel**”.
2. Select the **ANC** tab.

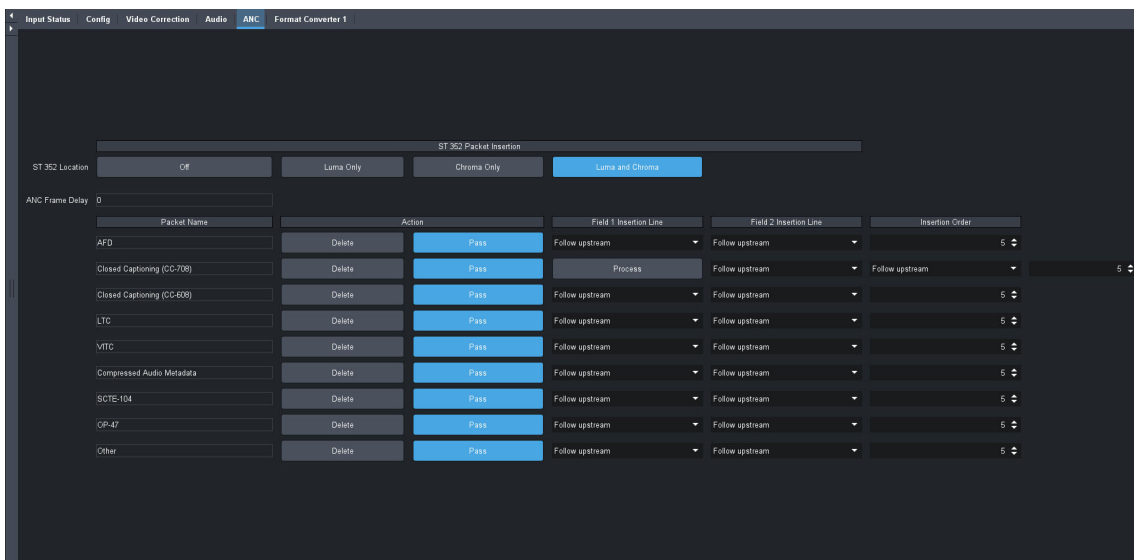

3. For each packet, select how the card processes the ANC data by selecting an option from the **Action** field.

- ★ It is recommended to set the Time Code and Audio Metadata fields to Disable when converting between interlace and progressive video.
- 4. Specify the line to insert the ANC data packet as follows:
 - Use the **Insertion Line** menu to select a line to insert the specified ANC packet on. The default is 12 for each packet. Note that all packets are inserted in VANC, except for timecode in non-SD formats which are inserted in the HANC.
 - Note that if more than one packet is to be inserted in the same line, the packet with the lowest insertion order number will be inserted first.
- 5. Specify the insertion order for the data packet as follows:
 - Use the **Insertion Order** menu to define the hierarchy of the packets insertion.
 - Note that the lower the number, the higher priority the packet is given. For example, by default, the AFD packet is set to be inserted first (1), and Compressed Audio Metadata is inserted fourth (4).

SMPTE ST 352 Packet Insertion

You can choose where to insert the SMPTE ST-352 packets.

To configure the location of insert SMPTE ST-352 packets

1. Display the **Gator Toolbox** interface as outlined in “**Accessing the GATOR-TOOLBOX Interfaces in DashBoard**”.
- ★ If the card is operating in Dual Channel mode, double-click the tree sub-node for the Toolbox channel you want to configure. Refer to “**To display the interface for a Toolbox channel**”.
2. Select the **ANC** tab.
 3. Locate the **ST 352 Packet Insertion** area of the tab.
 4. Use the **ST 352 Location** options to determine where to insert the SMPTE ST-352 packets in the GATOR-TOOLBOX output.
- ★ The packets are automatically inserted before the audio packets.

Audio Configuration

This chapter provides instructions for configuring the audio features using the menus in DashBoard.

For More Information on...

- Dual Channel mode, refer to “**Mapping the Audio Channels for Dual Channel Mode**”.

Configuring the AES Pairs

Before proceeding, ensure that you have made a note of the AES connections on your rear module. This information is required when assigning a function to each AES signal.

★ This section applies only to the GATOR-4A or GATOR-4B systems.

Selecting an AES Configuration

The GATOR-TOOLBOX enables you to configure the AES signals independently as inputs, outputs, or as a loopback. This section is applicable when the GATOR-TOOLBOX is operating in Single Channel mode.

★ If the card is operating in Dual Channel mode, refer to “**Mapping the Audio Channels for Dual Channel Mode**”.

To specify the AES configuration

1. Display the **Global** interface as outlined in “**Accessing the GATOR-TOOLBOX Interfaces in DashBoard**”.
2. Select the **Setup** tab.
3. Click **Configure AES IO Mapping**.
The **AES IO Mapping dialog** opens.
4. Locate the AES signal you wish to configure.
5. Select one of the following:
 - **Input** — assigns the AES signal as an input. The associated AES connector on the rear module will receive discrete audio from an upstream source.
 - **Output** — assigns the AES signal as an output. The associated AES connector on the rear module will transmit discrete audio to the connected external device.
6. Repeat steps 4 and 5 for each AES signal you wish to configure.
7. Close the **AES IO Mapping** dialog.

Configuring the AES Outputs

This section briefly summarizes how to configure the AES outputs using the options in the Audio > AES tab.

To configure the AES outputs

1. Display the **Gator Toolbox** interface as outlined in “**Accessing the GATOR-TOOLBOX Interfaces in DashBoard**”.
- ★ If the card is operating in Dual Channel mode, double-click the tree sub-node for the Toolbox channel you want to configure. Refer to “**To display the interface for a Toolbox channel**”.
2. Select the **Audio** tab.

3. Select the **AES** sub-tab.
4. Locate the column for the AES output you wish to configure.
5. Use the **Audio Source** options to assign a signal to channel 1 and 2 for the pair.
6. To set the gain for a channel of an AES output, use the associated **Gain** slider to select a value between -20dB and 20dB.
7. To set the delay for a channel of an AES output, use the associated **Delay Offset** slider to specify a value between 0ms and 500ms.
8. To invert a channel of an AES output, click the associated **Invert** button.
9. To sum the input (A+B/2) of the AES output, click the associated **Sum** button.
10. Repeat steps 4-9 for each AES output you wish to configure.

Processing the Embedded Audio Input

- ★ When passing non-PCM data (e.g. Dolby E®), ensure that input and output are synchronous and all audio modifying settings (such as SRC, gain, and invert) are disabled or set to zero (0).

To set up processing of the embedded audio input

1. Display the **Gator Toolbox** interface as outlined in “**Accessing the GATOR-TOOLBOX Interfaces in DashBoard**”.
- ★ If the card is operating in Dual Channel mode, double-click the tree sub-node for the Toolbox channel you want to configure. Refer to “**To display the interface for a Toolbox channel**”.
2. Select the **Audio** tab.
The **Embedded** sub-tab is automatically selected.
3. To enable the SRC of the embedded audio, select the **Sample Rate Conversion** box.
4. To apply a gain to a channel, use the associated **Ch #** slider to select a value between -20dB and 20dB. Repeat for each channel you wish to configure.
5. To invert a channel, select the associated **Ch # Invert** box.

Mapping the Embedded Audio Channels

The embedded output channels are configured per processed input to allow different audio mapping that will track the currently processed input.

To map a channel

1. Display the **Gator Toolbox** interface as outlined in “**Accessing the GATOR-TOOLBOX Interfaces in DashBoard**”.
- ★ If the card is operating in Dual Channel mode, double-click the tree sub-node for the Toolbox channel you want to configure. Refer to “**To display the interface for a Toolbox channel**”.
2. Select the **Audio** tab.
The **Embedded** sub-tab is automatically selected.
3. From the associated **Audio Source** menu, select an audio source.
In the example below, the user is assigning the source for SDI Ch 2.

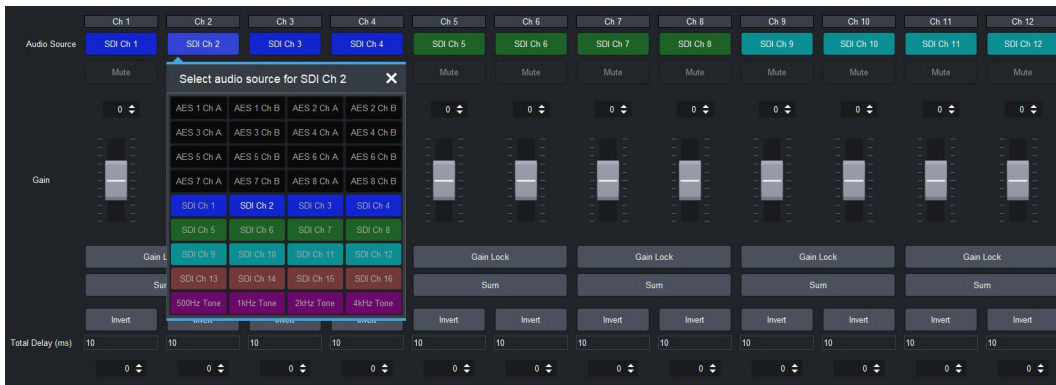

- ★ If the selected source is not present on the input video, silence is embedded.
- ★ Channel status bits are only passed when a left/right pair are not separated. Otherwise, a standard channel status will be inserted. When channel status is passed, it may not reflect a change between 20bit and 24bit.

To insert test tones

1. Display the **Gator Toolbox** interface as outlined in **“Accessing the GATOR-TOOLBOX Interfaces in Dashboard”**.
- ★ If the card is operating in Dual Channel mode, double-click the tree sub-node for the Toolbox channel you want to configure. Refer to **“To display the interface for a Toolbox channel”**.
2. Select the **Audio** tab.
 - The **Embedded** sub-tab is automatically selected.
 3. From the associated **Audio Source** menu, select a test tone.

In the example below, the user is assigning an 4kHz test tone to Channel 4.

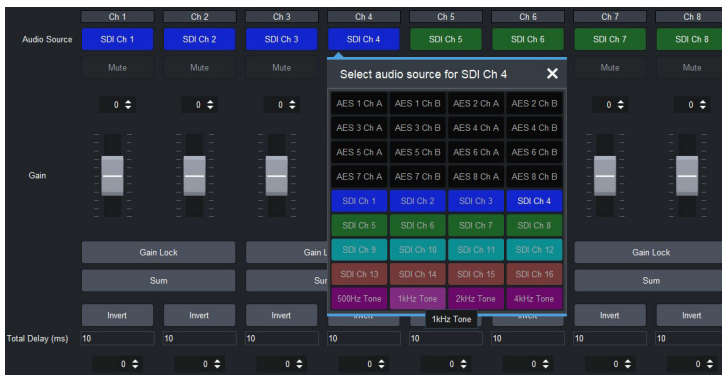

To mute a specific channel

- Click **Mute**.

Configuring the Audio Outputs for Dolby® E Metadata

The GATOR-TOOLBOX ingests a Dolby E encoded signal and extracts the Dolby E metadata embedded in the input audio signal and includes it on the metadata audio output. An option is provided to auto align the Dolby E encoded signal on output.

- ★ This section applies to Embedded and AES setups.

To configure the audio outputs for Dolby E

1. Display the **Gator Toolbox** interface as outlined in “**Accessing the GATOR-TOOLBOX Interfaces in DashBoard**”.
- ★ If the card is operating in Dual Channel mode, double-click the tree sub-node for the Toolbox channel you want to configure. Refer to “**To display the interface for a Toolbox channel**”.
2. Select the **Audio** tab.
The **Embedded** sub-tab is selected.
3. If you are configuring an embedded audio output, ensure the **Sample Rate Conversion** box is not selected (no check mark). This disables SRC.
4. If you are configuring an AES output, select the **AES** sub-tab.
5. Scroll down the tab to locate the **Dolby E Metadata** area.
6. Select the **Dolby Auto Align** box for the required AES output.
The AES output now includes the decoded AES pairs and the metadata. The Mute, Gain, Sum, Invert, and Manual Delay settings on the AES sub-tab are now disabled.
- ★ The output will take time before it settles on a valid Dolby E line.
7. Monitor the AES output status as reported in the **Dolby Status**, and **Egress Line** fields.
Refer to **Table 9** for a list of possible Dolby Status messages and their meanings.

Table 9 Possible Status Messages

Message	Is Dolby Decode egress functional?	Is Dolby Align functional?	Notes
Absent	No	No	No audio detected
AES not input	No	No	An AES channel pair is selected as an audio source however the corresponding I/O direction is set as output. The AES channel pair needs to be an input.
Dolby	Yes	Yes	<ul style="list-style-type: none"> • Non-PCM signal is detected. • Dolby metadata detected.
Dolby within Ideal Position	Yes	Yes	The Dolby Egress Line number is well within the ideal threshold as defined by the Dolby specifications.
Incompatible Reference	No	No	Verify that the card reference (Setup > Reference Source menu) is compatible with the output format. Refer to “ Frame Rate Compatibility ”.
No Dolby Header	No	No	<ul style="list-style-type: none"> • Non-PCM signal is detected. • Dolby metadata is not detected.
PCM	No	No	<ul style="list-style-type: none"> • PCM signal detected. • Dolby E metadata cannot be detected on a PCM signal. • Provide a non-PCM audio source.

Table 9 Possible Status Messages (Continued)

Message	Is Dolby Decode egress functional?	Is Dolby Align functional?	Notes
SRC bypass needed	No	No	<ul style="list-style-type: none">• Sample Rate Conversion is not disabled.• Verify the Sample Rate Conversion box, located at the top of the tab, is not selected (does not display a check-mark).
Wrong Channel Pair	No	No	<ul style="list-style-type: none">• Verify the audio source to ensure that the audio is from channel pairs.• Verify that the Channel > Audio Source is not set to a test tone.

Using Presets

This chapter outlines how to store and recall a GATOR-TOOLBOX configuration using a **Preset** button on the Global interface in DashBoard.

★ Presets are retained after a factory default is performed.

Overview

Up to eight presets can be defined, each capturing a unique GATOR-TOOLBOX configuration as required. These presets can then be recalled using the individual **Preset** buttons on the Global > Presets tab.

Table 10 summarizes the GATOR-TOOLBOX settings that are captured in a single preset.

Table 10 Settings Captured in a Preset

Tab	Setting
Gator Toolbox Interface	
ANC	All editable menus
Audio	All editable menus
Config	All editable menus
Format Converter	Detail Enhancement > Vertical
	Detail Enhancement > Horizontal
Input Status	All selectable boxes
Video Correction	SDR/HDR Conversion > All editable menus
	Color Correction > All editable menus
Global Interface	
Global Alarm Enables	All Alarm Enable boxes
Security	SSH Login
Setup	All editable menus

Storing a Preset

★ Before proceeding ensure that the GATOR-TOOLBOX is configured how you want it for the preset.

To store your settings to a preset

1. Display the **Global** interface as outlined in “**Accessing the GATOR-TOOLBOX Interfaces in DashBoard**”.
2. Select the **Preset** tab.
3. Click the **Preset** button in the **Select Presets** area that you want to store the current configuration to.
4. In the text field of the **Preset Actions** area, type a unique identifier for the preset.
This text will display as the button label.

5. Click **Store**.

The settings are stored to the selected preset and name of the button updates.

To edit a preset

1. Update the GATOR-TOOLBOX configuration as required.
2. Select the **Global > Preset** tab.
3. Click the required **Preset** button.
4. Click **Store**.

Recalling a Preset

Recalling a preset applies the settings saved to that specific preset during the procedure “**To store your settings to a preset**”. Refer to **Table 10** to learn which settings are captured in a preset.

To recall a preset

1. Display the **Global** interface as outlined in “**Accessing the GATOR-TOOLBOX Interfaces in DashBoard**”.
2. Select the **Preset** tab.
3. Click the **Preset** button that includes the settings you want to recall to the GATOR-TOOLBOX.
4. Click **Recall**.

The selected button is lit and the configuration is recalled.

Upgrading the Software

The GATOR-TOOLBOX can be upgraded in the field via DashBoard.

★ Ensure the **Global > Security > Software Upgrades** option is selected.

To upgrade the software on a card

1. Contact Ross Technical Support for the latest software version file.
 2. Ensure the Ethernet cable is connected to the **Ethernet** port on the openGear frame.
 3. From the **Tree View**, expand the node for the GATOR-TOOLBOX you want to access.
 4. Double-click the **Global** sub-node to display the interface in the right-half of DashBoard.
 5. Select **Upload**, located near the bottom of the interface, to display the **Select file Upload** dialog.
 6. Navigate to the ***.bin** file you want to upload.
 7. Click **Open**.
 8. If you are upgrading a single card:
 - a. Click **Finish** to start the upgrade.
 - b. Proceed to step 10.
 9. If you are upgrading multiple cards:
 - a. Click **Next >** to display the **Select Destination** menu. This menu provides a list of the compatible cards.
 - b. Specify the card(s) to upload the file to by selecting the check box(es) for the cards you want to upload the file to.
 - c. Verify the card(s) you want to upload the file to. The **Error/Warning** fields indicate any errors, such as incompatible software or card type mismatch.
 - d. Click **Finish**.
 10. Monitor the upgrade.
 - An **Upload Status** dialog enables you to monitor the upgrade process.
 - Notice that each card is listed in the dialog with a  button. This button is replaced with a **Reboot** button once the software file is loaded to that card.
- ★ Avoid clicking the individual Reboot buttons until all cards have successfully completed the file upload process and the OK button, located in the bottom right corner of the dialog, is enabled.
- Click **OK** to reboot all the cards listed in the **Uploading to Selected Devices** dialog.
 - The **Reboot Confirm** dialog displays, indicating the number of cards that will reboot.
 - Click **Yes** to continue the upgrade process.
- ★ Clicking **Cancel** or **No** returns you to the **Uploading to Selected Devices** dialog without rebooting the card(s).
- The card(s) are temporarily taken off-line during the reboot process.
 - The process is complete once the status indicators for the **Card State** and **Connection** return to their previous status.

DashBoard Interface Overview

The DashBoard client software enables you to monitor, configure, and operate your GATOR-TOOLBOX. This chapter summarizes the interfaces, and tabs available in DashBoard for the GATOR-TOOLBOX.

Global Interface

The Global interface is accessed by double-clicking the Global sub-node in the GATOR-TOOLBOX tree. There are two areas in the Global interface: Status (on the left), and Configuration (on the right). (Figure 45)

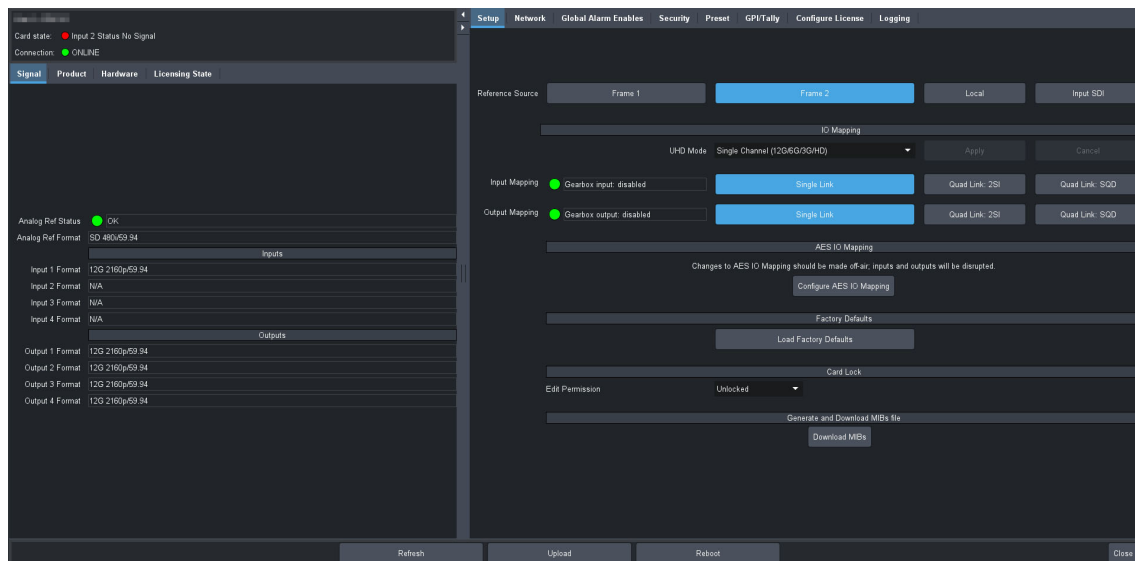

Figure 45 Example of the Global Interface

Signal Tab

Table 11 summarizes the read-only fields displayed in the **Signal** tab.

Table 11 Signal Tab

Item	Parameters	Description
Analog Ref Status	OK (Green)	A valid signal is detected from the reference source device
	Alarm suppressed (Green)	There are reference errors detected but the Global Alarm Enables > Reference Error option is disabled (box is not selected)
	Unsupported (Red)	An unsupported signal is detected from the reference source device
	Unlocked (Red)	A valid or present reference signal is not detected by the card
Analog Ref Format	#	Reports the video format detected on the input reference signal as defined by the Setup > Reference Source menu.
Inputs		

Table 11 Signal Tab (Continued)

Item	Parameters	Description
Input # Format	#	A valid SDI signal is detected on the input, the format is supported, and the selected reference signal is supported and compatible
	N/A	An invalid SDI signal is detected on the input
Outputs		
Output # Format	#	A valid SDI signal is detected on the output, the format is supported, and the selected reference signal is supported and compatible
	N/A	An invalid SDI signal is detected on the output

Product Tab

Table 12 summarizes the read-only information displayed in the Product area.

Table 12 Product Tab

Item	Parameters	Description
Product	GATOR-TOOLBOX	
Supplier	Ross Video Ltd.	
Board Rev	#	Indicates the hardware version
Serial Number	#	Indicates the serial number of the card
Rear Module	#	Indicates the rear module Pthe card is installed in
Rear Module Status	OK (Green)	A supported rear module is installed with the card
	Alarm suppressed (Green)	An unsupported rear module is installed and the Global Alarm Enables > Incompat Rear Module option is disabled (box is not selected)
	Incomp I/O Module (Red)	Card is connected to an unsupported rear module
Software Rev	##-##	Indicates the software version running on the card
Firmware Rev	##	Indicates the firmware version running on the card
CPLD Rev	##	Indicates the complex programmable logic device version of the GATOR-TOOLBOX
Daughter Card		

Table 12 Product Tab (Continued)

Item	Parameters	Description
Type	#	Indicates the daughter card model installed on the card
Variant	#	
Issue	#	Indicates the hardware version of the daughter card

Hardware Tab

Table 13 summarizes the read-only information displayed in the Hardware tab.

Table 13 Hardware Tab

Item	Parameters	Description
Hardware Status	OK (Green)	Fans are operating correctly; no errors are detected
	Alarm suppressed (Green)	There are fan errors detected but the Global Alarm Enables > Stalled Fan option is disabled (box is not selected)
	Critical Temperature (Red)	The FPGA temperature is 100°C (212°F) or above
	Fan Off/Stalled (Red)	The fan installed on the GATOR-TOOLBOX is not operating correctly
Voltage (mV)	#	Measured input millivolts
Current (mA)	#	Current consumption in milliamperes
Power (W)	#	Power consumption in watts
FPGA Temp (C)	#C	Indicates the FPGA Core temperature where: <ul style="list-style-type: none">• A green indicator displays when the temperature is less than 95°C.• A yellow indicator displays when the temperature is greater than or equal to 95°C.• A red indicator displays when the temperature is greater than or equal to 100°C (212°F). *If the temperature is greater than 100°C (212°F), the user must manually power down the card.
AXI Bridge	#	The Advanced extensible interface bridge is running correctly on the GATOR-TOOLBOX. This information is for Ross Technical Support.
Fan Speed	#	Reports the speed (rpm) of the fan on the board

Table 13 Hardware Tab (Continued)

Item	Parameters	Description
CPU Usage	x.xx / y.yy / z.zz	Displays the CPU Load average where: <ul style="list-style-type: none"> • x.xx represents in the last minute • y.yy represents the last five minutes • z.zz represents the last fifteen minutes
Uptime (System/App)	x / y	Reports the amount of time since the last reboot, or loss of connectivity, of the card
RAM Available	# / # MB	CPU Memory Used / Total CPU Memory
SD Card Status	# of #GB used	Reports the amount of memory used on the Micro SD card
Daughter Card		
Voltage (mV)	#	Measured daughter card input millivolts
Current (mA)	#	Current consumption of the daughter card in milliamperes
Power (W)	#	Power consumption of the daughter card in watts

Licensing State Tab

Table 14 summarizes the read-only information displayed in the Licensing State tab.

Table 14 Licensing State Tab

Item	Parameters	Description
GATOR-TOOLBOX+UHD		
License State	Unlicensed	The license key for the feature is not installed. Navigate to the Configure License tab to enable this feature
	Licensed	The license key for the GATOR-TOOLBOX+UHD feature was correctly enabled in the Configure License tab
License Count	x of y	Reports the GATOR-TOOLBOX+UHD licenses where: <ul style="list-style-type: none"> • x represents the number of licenses enabled for this card • y represents the maximum number of licenses for this card
GATOR-TOOLBOX+FRC		
License State	Unlicensed	The license key for the feature is not installed. Navigate to the Configure License tab to enable this feature
	Licensed	The license key for the GATOR-TOOLBOX+FRC feature was correctly enabled in the Configure License tab

Table 14 Licensing State Tab (Continued)

Item	Parameters	Description
License Count	x of y	Reports the GATOR-TOOLBOX+FRC licenses where: <ul style="list-style-type: none"> • x represents the number of licenses enabled for this card • y represents the maximum number of licenses for this card
GATOR-TOOLBOX+HDR-LUT		
License State	Unlicensed	The license key for the feature is not installed. Navigate to the Configure License tab to enable this feature
	Licensed	The license key for the GATOR-TOOLBOX+HDR-LUT feature was correctly enabled in the Configure License tab
License Count	x of y	Reports the GATOR-TOOLBOX+HDR-LUT licenses where: <ul style="list-style-type: none"> • x represents the number of licenses enabled for this card • y represents the maximum number of licenses for this card
License Allocation > Channel > Toolbox #^a		
Frame Rate Conversion	Licensed	Indicates that a GATOR TOOLBOX+FRC license was enabled for this Toolbox channel
	Unlicensed	This Toolbox channel does not have a GATOR TOOLBOX+FRC license enabled
HDR 3D LUT File Support	Licensed	Indicates that a GATOR TOOLBOX+HDR-LUT license was enabled for this Toolbox channel
	Unlicensed	This Toolbox channel does not have a GATOR TOOLBOX+HDR-LUT license enabled

a. This area is applicable only when in Dual Channel mode.

Setup Tab

Table 15 summarizes the options displayed in the Setup tab that are available for all UHD Modes.

Table 15 Setup Tab

Item	Parameters	Description
Reference Source	Frame 1	Uses the reference signal connected to the REF 1 BNC on the openGear frame
	Frame 2	Uses the reference signal connected to the REF 2 BNC on the openGear frame
	Local	Uses the reference signal connected to the REF IN port on the GATOR-TOOLBOX rear module
	Input SDI	Uses the video signal connected to the SDI IN port on the rear module
	Input Fiber ^a	Uses the video signal connected to the specified SDI IN port of SFP 1. This option only displays when using the R4F-GATOR rear module. Refer to " R4F-GATOR Rear Module " for port designations.
IO Mapping		
UHD Mode	Single Channel (12G/3G/HD)*	The card provides a single channel that supports video formats up to 2160p
	Dual Channel (3G/HD)	The card provides two independent channels that each support video formats up to 1080p
Bi-directional Mapping^b		
Bi-directional #	Input	Configures this HD-BNC as an input
	Output	Configures this HD-BNC as an output
Factory Defaults		
Load Factory Defaults	All editable parameters in DashBoard, except those in the Network tab, are reset to the factory default values	
Generate and Download MIBs File		
Download MIBs	Downloads the Management Information Base (MIB) file that provides the SNMP controls for your card.	

- a. This option requires the R4F-GATOR (8323AR-327) rear module.
- b. This option requires the R4F-GATOR (8323AR-327) rear module.

Table 16 summarizes the options displayed in the Setup tab when the **UHD Mode** is set to **Single Channel**.

Table 16 Setup Tab — UHD Mode > Single Channel

Item	Parameters	Description
IO Mapping		
Input Status (read-only)	Gearbox input: enabled	The Gearbox feature is currently in use on the inputs
	Channel not in sync	
	Gearbox input: disabled	The Gearbox feature is not in use on any inputs
Input Mapping	Single Link	The GATOR-TOOLBOX ingests one 12Gbps signal
	Quad Link: 2SI	The GATOR-TOOLBOX ingests four 3Gbps Level A 2SI signals
	Quad Link: SQD	The GATOR-TOOLBOX ingests four 3Gbps SQD signals
	Fiber ^a	The GATOR-TOOLBOX ingests one 12Gbps signal via the SDI IN connection of SFP 1 and outputs one 12Gbps via the SDI OUT connection of SFP 1. The Output Mapping is automatically set to Single Link and cannot be changed. Refer to “ R4F-GATOR Rear Module ” for port designations.
Output Status (read-only)	Gearbox output: enabled	The Gearbox feature of the GATOR-TOOLBOX is currently in use on the outputs
	Gearbox output: disabled	The Gearbox feature is not in use on any outputs
Output Mapping	Single Link	The GATOR-TOOLBOX outputs a single 12Gbps signal
	Quad Link: 2SI	The GATOR-TOOLBOX outputs four 3Gbps Level A 2SI signals
	Quad Link: SQD	The GATOR-TOOLBOX outputs four 3Gbps SQD signals. This option is unavailable when the Input Mapping field is set to Quad Link: SQD.
AES IO Mapping^b		
Configure AES IO Mapping	Click this button to display the AES IO Mapping dialog and assign the AES signals to the GATOR-TOOLBOX inputs and outputs	
AES #	Input	Assigns the AES signal as an input
	Output	Assigns the AES signal as an output

a. This option is only available when using the R4F-GATOR (8323AR-327) rear module.

b. This area is only available when using the R3A-GATOR (8322AR-319C) or R3B-GATOR (8322AR-318D) rear modules.

Table 17 summarizes the options displayed in the Setup tab when the **UHD Mode** is set to **Dual Channel**.

Table 17 Setup Tab — UHD Mode > Dual Channel

Item	Parameters	Description
AES IO Mapping^a		
Configure AES IO Mapping	Click this button to display the AES IO Mapping dialog and assign the AES signals to the GATOR-TOOLBOX inputs and outputs	
AES Output Assign	Toolbox 1	Assigns the AES outputs to Toolbox Channel 1
	Toolbox 2	Assigns the AES outputs to Toolbox Channel 2

a. This area is only available when using the R3A-GATOR (8322AR-319C) or R3B-GATOR (8322AR-318D) rear modules.

Network Tab

Table 18 summarizes the menus and read-only fields displayed in the Network tab.

Table 18 Network Tab

Item	Parameters	Description
Network Time		
Use Time from Network Controller Card	Selected*	Enables the GATOR-TOOLBOX to use the time data reported by the MFC-OG3-N or MFC-OGX-N that is installed in the same openGear frame. This setting is not reset after a factory default is performed.
	Cleared	
Default Gateway		
Current (read-only)	###.###	Indicates the gateway for communications outside of the local area network (LAN)
Static Gateway	###.###	The Gateway for the GATOR-TOOLBOX that the user manually assigned
openGear Chassis RJ-45		
Link Status (read-only)	OK (Green)	The GATOR-TOOLBOX is communicating on the network via the Network Controller Card
	Invalid Subnet Mask (Yellow)	The Current Subnet Mask value is set incorrectly or is invalid within your network
	Apply/Cancel Changes (Yellow)	One or more setting on this tab was changed but the Apply button was not selected
	Link Down (Red)	The link for the Network Controller Card is invalid
Current IP Address (read-only)	###.###	Indicates the IP Address currently assigned to the GATOR-TOOLBOX via the Network Controller Card

Table 18 Network Tab (Continued)

Item	Parameters	Description
Current Subnet Mask (read-only)	###.#	Indicates the subnet mask for the GATOR-TOOLBOX
Current Gateway (read-only)	###.#.#	Indicates the gateway for communications outside of the local area network (LAN)
MAC Address (read-only)	#	Indicates the MAC Address currently assigned to the GATOR-TOOLBOX
Mode	Static	The user manually supplies the network settings for the GATOR-TOOLBOX
	DHCP*	Automates the assignment of network settings for the GATOR-TOOLBOX
Static IP Address	#	The IP Address for the GATOR-TOOLBOX that the user manually assigned
Subnet Mask	#	The Subnet Mask for the GATOR-TOOLBOX that the user manually assigned
Static Gateway	###.#.#	The Gateway for the GATOR-TOOLBOX that the user manually assigned

Global Alarm Enables Tab

Table 19 summarizes the options displayed in the Global Alarm Enables tab.

Table 19 Global Alarm Enables Tab

Item	Parameters	Description
Network Alarm		
Network Time (read-only)	#	Displays the time data transmitted by the Frame Controller card in the same openGear frame. Requires that the Global > Network > Use time from Frame Controller box is selected.
Alarm Enable	Selected*	Reports when a loss of connection to the Frame Controller card occurs
	Cleared	Disables this alarm
Rear Module Alarm		
Status (read-only)	OK (Green)	The rear module installed with the GATOR-TOOLBOX is a supported model
	Alarm Suppressed (Green)	The Alarm Enable box is cleared. The status of the rear module will not be reported.
	Incompat Rear Module (Red)	The rear module installed with the GATOR-TOOLBOX is not supported. Refer to “Supported Rear Modules” for a list of supported rear modules.

Table 19 Global Alarm Enables Tab (Continued)

Item	Parameters	Description
Alarm Enable	Selected*	The Global > Product > Rear Module Status field reports when a rear module is not compatible with the card
	Cleared	Disables this alarm
Fan Alarm		
Fan Speed (read-only)	#	Reports the fan speed (rpm) of the fan on the board
Alarm Enable	Selected*	The GATOR-TOOLBOX reports when the fan is not working correctly
	Cleared	Disables this alarm
Analog Reference Alarm		
Reference Format (read-only)	OK (Green)	Indicates the detected reference format is supported
	Alarm Suppressed (Green)	The Alarm Enable box is cleared. The status of the reference signal will not be reported.
	Unlocked (Red)	A reference signal is detected, but the card is not locked to it
	Unsupported (Red)	A reference signal is detected, but the format is not supported by the GATOR-TOOLBOX
	Incompatible (Red)	A reference signal is detected but the format is incompatible with the current output mode of the card/channel
Alarm Enable	Selected*	The Global > Signal > Analog Reference Status field reports when there is a loss of reference signal. When operating in Dual Channel mode, this also enables the monitoring of the output reference status for each Toolbox channel. If either of the output formats configured on Toolbox channel 1 and Toolbox channel 2 are not compatible with the Input reference, a "Reference Status Incompatible" message displays in the Card state field in the top left corner of the Global interface.
	Cleared	Disables this alarm
SDI Input Alarms		
Input # Status (read-only)	This field duplicates the information reported in the Input Status field as outlined in Table 25 .	
Alarm Enable	Selected*	GATOR-TOOLBOX reports a loss of the specified input or if the format is incompatible for the specified input
	Cleared	Disables this alarm

Security Tab

Table 20 summarizes the options displayed in the Security tab.

Table 20 Security Tab

Item	Parameters	Description
Security Configuration		
SSH Login	Disable*	Disables the ability for a user to log onto the GATOR-TOOLBOX via a SSH client
	Enable	The GATOR-TOOLBOX can be accessed via a secure channel by an SSH client. This should only be selected if directed to do so by Ross Video Technical Support.
Software Upgrade	Disable*	The GATOR-TOOLBOX software cannot be upgraded
	Enable	The software on the GATOR-TOOLBOX can be upgraded via the Upload button in the DashBoard interface

Preset Tab

Table 21 summarizes the options in the Preset tab.

Table 21 Preset Tab

Item	Parameters	Description
Selected Presets		
Preset #	<text>	Specifies which preset will be stored/edited/recalled to the GATOR-TOOLBOX
Preset Actions		
Rename	<text>	Applies a new label to the selected Preset button
Store	Captures the current configuration of the GATOR-TOOLBOX and saves it to the selected Preset button.	
Recall	Applies the configuration of the selected Preset button to the GATOR-TOOLBOX	

GPI/Tally Tab

Table 22 summarizes the options displayed in the GPI/Tally tab.

Table 22 GPI/Tally Tab

Item	Parameters	Description
GPI/Tally #		
Channel #	Toolbox 1	Assigns the specified GPIO port to the selected Toolbox channel. This column only displays when the UHD Mode is set to Dual Channel .
	Toolbox 2	

Table 22 GPI/Tally Tab (Continued)

Item	Parameters	Description
Function	None*	The specified GPIO port is not configured and the GPI has no effect. The Trigger/Tally Type setting is ignored.
	Tally Failover Active	The GPIO port will trigger when the card enters the failover state. It reflects whether the card is in failover state, either by Force Failover or automatic failover.
	General Output	is useful for troubleshooting external equipment that is sending GPIs to Toolbox. The user can see the state change without affecting the state of the card. Unlike the General Output, it doesn't need the Manual Override option to be enabled.
	GPI Force Failover	The port will trigger/enable/disable the Force Failover option
	General Input	When the card receives a trigger on the selected GPI input, it runs the events that have been assigned to the GPI input.
Trigger/Tally Type	Edge Falling*	The selected function is executed when the GPI input signal transitions from High to Low
	Edge Rising	The selected function is executed when the GPI input signal transitions from Low to High
	Level High	The selected function is executed when the GPI input signal is driven High
	Level Low	The selected function is executed when the GPI input signal is driven Low
Current State (read-only)	#	Reports the state of the port (whether is an input or an output)
Manual Override		
Output Pulse Width (frames)	#	Specifies the number of frames between the rising and falling edges of the output
Enable	Selected	The user will trigger a switch in states
	Cleared	The port will trigger a switch in states
Level	Low	When the user triggers a switch, the GPI input signal is driven Low
	High	When the user triggers a switch, the GPI input signal is driven High
GPI/Tally Logging Level		

Table 22 GPI/Tally Tab (Continued)

Item	Parameters	Description
Emergency	<ul style="list-style-type: none"> Events are listed in a hierarchical order based on the selected severity including: <ul style="list-style-type: none"> internal errors and unrecognized or invalid responses from the GPI/Tally port failed communications between the GATOR-TOOLBOX (such as time outs) and the device connected to the GPI/Tally port. This is intended for troubleshooting incompatibilities between the GATOR-TOOLBOX and downstream devices. The GATOR-TOOLBOX provides a summary of commands sent to and responses via this GPI/Tally port 	
Alert		
Critical		
Error		
Warning		
Notice		
Info*		

Configure License Tab

Table 23 summarizes the read-only information displayed in the Configure License tab.

Table 23 Configure License Tab

Item	Parameters	Description
Feature	<text>	Specifies the license(s) available for your card
Request Code	#	This character string is used to obtain a license key
State	Unlicensed	The license key for the feature is disabled
	Licensed	The license key for the feature was correctly enabled
Key	#	Specifies the license key that was provided for the specified feature
License Count (read-only)	x of y	Indicates the number of available licenses where: <ul style="list-style-type: none"> x represents the number of licenses enabled for this card y represents the maximum number of licenses for this card
License Allocation > Channel > Toolbox #		
Frame Rate Conversion	Selected	Indicates that a GATOR TOOLBOX+FRC license was enabled for this Toolbox channel
	Cleared	This Toolbox channel does not have a GATOR TOOLBOX+FRC license enabled
HDR 3D LUT File Support	Selected	Indicates that a GATOR TOOLBOX+HDR-LUT license was enabled for this Toolbox channel
	Cleared	This Toolbox channel does not have a GATOR TOOLBOX+HDR-LUT license enabled

Logging Tab

Table 24 summarizes the menus and read-only fields displayed in the Logging tab.

Table 24 Logging Tab

Item	Parameters	Description
Logging Level	Filters the events the System Log captures	
Remote Logging	#. #. #. #	Specifies the IP Address for the external device that is logging the communication activity for the GATOR-TOOLBOX
System Log	Displays the events logged for the GATOR-TOOLBOX since the last time the log was cleared	

Gator Toolbox Interfaces

Double-click the Gator Toolbox sub-node to display the configuration options for the channel in the right pane of the DashBoard window. (**Figure 46**)

- ★ When the UHD Mode is set to Dual Channel, there are two Gator Toolbox sub-nodes in the tree view. Refer to **“Dual Channel Mode Setup”** for details. The tabs, fields, and parameters are the same for both, but each channel is configured separately.

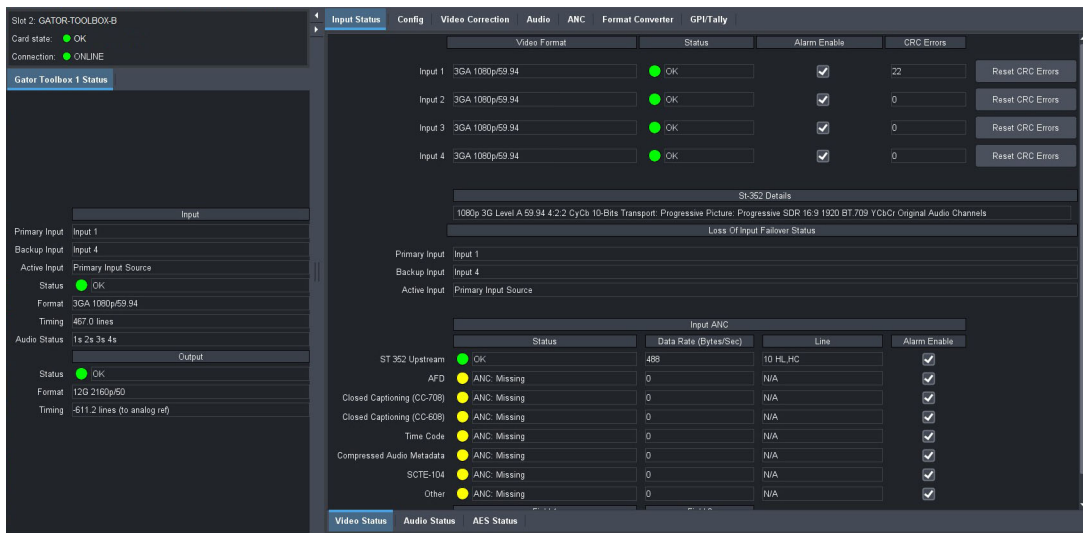

Figure 46 Example of a Gator Toolbox Channel Interface in Dashboard

Gator Toolbox Status Tab

Table 25 summarizes the read-only fields displayed in the Status tab for the channel.

Table 25 Gator Toolbox Interface — Gator Toolbox # Status

Item	Parameters	Description
Input		
Primary Input	#	Indicates the source for the active SDI input signal
Backup Input	#	Indicates the source for the backup SDI input signal

Table 25 Gator Toolbox Interface — Gator Toolbox # Status (Continued)

Item	Parameters	Description
Active Input	Primary Input Source	Indicates that the Primary Input Source is the active input signal for the card/channel. The signal is assigned via the Config > Primary Video Source menu.
	Backup Input Source	Indicates that the Backup Input Source is the active input signal for the card/channel. The signal is assigned via the Config > Backup Video Source menu.
Status	OK (Green)	No errors are detected on the video signal of the specific SDI IN BNC
	Alarm suppressed (Green)	The GATOR-TOOLBOX is not monitoring the input signal(s)
	Frozen Video (Yellow)	The signal has frozen on the last valid frame of video
	Unsupported Format (Yellow)	An input signal is detected on the specific SDI IN BNC but the video is not supported by GATOR-TOOLBOX
	Incompatible Video (Yellow)	An input signal is detected on the specific SDI IN BNC but its format is not compatible with the output video format
	Not time to Ref (Yellow)	An input signal is detected on the specific SDI IN BNC but the detected reference signal is incompatible with this input signal
	Gearbox: Format not 3G (Yellow)	An input signal is detected on the specific SDI IN BNC but it is a format other than 1080p 59.94Hz or 1080p 50Hz
	Gearbox: Frame rate mismatch (Yellow)	The frame rate on the specified input signal does not match the output frame rate
	Gearbox: Timing mismatch (Yellow)	The input signals for the Gearbox are not co-timed
	No Signal (Red)	Indicates one of the following issues is occurring: <ul style="list-style-type: none"> • the SDI input signal is not detected • SDI IN 1 is not detected in Single Link mode • the system frame rate does not match the input frame rate
Format	#	Indicates the input video format
	Invalid Selection	The input video format is not supported or does not match the reference format
Timing	Lines: #, Pixels: #	Indicates the timing offset between the video input signal and the reference signal. The unit of measure is lines and pixels with respect to the input video format.

Table 25 Gator Toolbox Interface — Gator Toolbox # Status (Continued)

Item	Parameters	Description
Audio Status	#a #x #s #s	Indicates the input audio status where: <ul style="list-style-type: none"> • # represents the audio group (e.g. 1, 2, 3, 4) • a represents an async audio group • x represents a missing audio group • s represents a sync audio group
Output		
Status	OK (Green)	Indicates that no errors are detected on the video signal of the corresponding SDI OUT BNC
	Alarm Suppressed (Green)	The output signal is not monitored by GATOR-TOOLBOX
	Test Pattern: Color (Green)	The current output of the card/channel is set to a test pattern (Config > Output Format)
	Matte Pattern (Green)	The current output of the card/channel is set to black (Config > Output Format)
	Incompatible Reference (Red)	When in Dual Channel mode, indicates that a reference signal is detected but the format is incompatible with the current output mode of the this Toolbox channel. The Global Alarms Enable > Analog Reference Alarm box is selected.
	No Lock (Red)	A reference signal is detected, but the GATOR-TOOLBOX output is not locked to it
Format	Frame Rate Conversion license required (Red)	You must enter a license key for the GATOR-TOOLBOX+FRC licensed feature
	#	Indicates the output video format
Timing	Invalid Selection	The input video format is not supported or does not match the reference format
	# lines (to x)	Indicates the timing offset between the video output signal and the reference signal where x represents the reference signal specified in the Config > Sync Mode menu

Input Status Tab

The Input Status tab is organized into three sub-tabs: Video Status, Audio Status, and AES.

Video Status Tab

Table 26 summarizes the read-only fields displayed in the Video Status tab.

Table 26 Input Status — Video Status

Item	Parameters	Description
Input # or Bi-directional #^a		
Video Format	#	Indicates the detected input format
Status (read-only)	Duplicates the information reported in the Gator Toolbox Status fields	
Alarm Enable	Selected*	An alarm is reported during a loss of the specified input or the format is incompatible for the specified input
	Cleared	Disables the alarm
CRC Errors	#	Displays the count of the CRC errors on the video input. This counter is reset on loss of video, or by user request. The counter is non-latching, and the count can roll over the counter
	Reset	Resets the CRC Errors field
ST-352 Details		
Status	#	352M is detected and the 4 bytes are displayed
Loss of Input Failover Status		
Primary Input (read-only)	Input #	Reports the SDI signal assigned as the primary SDI input. This is set in the Config tab.
Backup Input (read-only)	Input #	Reports the SDI signal assigned as the backup SDI input. This is set in the Config tab.
Active Input (read-only)	Primary Input Source	Reports which SDI signal (Primary or Backup) is the currently active input signal
	Back Input Source	
Input ANC		
Status (read-only)	ANC: Present (Green)	Expected incoming ANC data: present
	ANC: Exceeded Bandwidth	Captured VANC services exceeded bandwidth
	ANC: Missing	Expected incoming ANC data: not present
	ANC: Present in Luma and Chroma	Incoming data was found on both LUMA and CHROMA channels
	ANC: Unexpected: Field #	Receiving ANC data from wrong field
	ANC: Unexpected: LUMA	Receiving ANC data from wrong channel
	ANC: Unexpected: CHROMA	Receiving ANC data from wrong channel
	ANC: Line Out of Range	Receiving data from wrong line
	ANC: Too Many Packets in Frame	
	ANC: Not Assigned	The required output port has not been assigned

Table 26 Input Status — Video Status (Continued)

Item	Parameters	Description
Status (read-only)	ANC: Not Connected	The output has been assigned, but is not connected
	ANC: Overflow	Exceeded output bandwidth. Lost data.
	ANC: CRC Error	CRC error found in incoming ANC data: some protocols only
	ANC: Parse Error	Incoming data does not match expected protocol
	ANC: Invalid Length	The length of incoming ANC packet is incorrect for service
Data Rate (Bytes/Sec)	#	Reports the upstream data transfer rate; the number of bytes received in the last field
Field # Line	# VL, VC	Reports the upstream data insertion location
	N/A	
Alarm Enable	Selected*	The GATOR-TOOLBOX monitors the Input ANC status and updates the Status field accordingly
	Cleared	Disables this alarm
Field #		
Bandwidth Used (%)	#	The overall bandwidth percentile including buffer overflow state, of all incoming ANC services on the SDI input

a. Bi-directional ports are only available on the R4F-GATOR (P/N 8323AR-327) rear module.

Audio Status Tab

Table 27 summarizes the read-only fields displayed in the Audio Status tab.

Table 27 Input Status — Audio Status

Item	Parameters	Description
Embedded Audio Status - Group #		
Ch # Status (read-only)	PCM	The channel is PCM audio
	Non-PCM	The channel is non-PCM audio
	Absent	The audio channel is not detected or invalid
Async Alarm	Selected*	An alarm is reported when the embedded audio is incompatible
	Cleared	Disables the alarm
Presence Alarm	Selected*	An alarm is reported when the embedded audio is not present
	Cleared	Disables the alarm

AES Status Tab

Table 28 summarizes the options, and read-only fields displayed in the AES Status tab.

★ This tab only displays when using an R3A-GATOR (8322AR-319C) or R3B-GATOR (8322AR-318D) rear module.

Table 28 Input Status — AES Status

Item	Parameters	Description
AES # Input^a		
Sample Rate Conversion	Selected	SRC is used on the input of the specified AES signal
	Cleared	SRC is not used on the input of the specified AES signal. Select this option when using non-PCM audio data.
Ch # Status (read-only)	PCM (Green)	Displays the status of the specified channel input
	PCM-silent (Green)	
	Non-PCM (Green)	
	No Input (Red)	
	Async ^b (Red)	
Word Length (read-only)	#bit	Reports the number of bits of audio
Sample Rate (read-only)	#kHz	Reports the sample rate of the AES input
Emphasis (read-only)	Yes	The incoming AES signal is indicating 50/15 or CCiTT J.17 emphasis
	No	The incoming AES signal is indicating no emphasis or the emphasis is not indicated
Presence Alarm ^c	Selected*	The Input Status > AES Status tab reports when the specified AES input is not detected
	Cleared	Disables the alarm.
Async Alarm ^c	Selected	The AES source is either asynchronous to the input video, or is not a 48kHz rate
	Cleared	Disables the alarm. The AES input is not monitored.

- The fields on this tab are disabled if the AES signal is configured as an output.
- If the Sample Rate Conversion is enabled, an Async AES signal is processed to be PCM and indicated as such.
- This option is disabled if the AES signal is configured for loopback.

Config Tab

Table 29 summarizes the menus displayed in the Config tab.

Table 29 Config Tab

Item	Parameters	Description
Input Setup		
Primary Video Source	Input #	Specifies an SDI input for the Primary input signal when the Loss of Input Failover mode is enabled
Backup Video Source	Input #	Specifies the SDI input for the Backup input signal when the Loss of Input Failover mode is enabled
Configure Loss of Input		
Primary Input (read-only)	Input #	Reports the SDI signal assigned as the Primary SDI input
Backup Input (read-only)	Input #	Reports the SDI signal assigned as the Backup SDI input
Active Input (read-only)	#	Reports which SDI signal (Primary or Backup) is the currently active input signal
Loss of Input Failover	ON	Enables the feature where one specified input video signal (as defined by the Primary Video Source menu) is the primary source and a second source is defined as the Backup Video Source (by default).
	OFF*	Disables this feature
Force Failover	Normal*	The card automatically switches input video sources when a loss of input signal is detected
	Forced	The user must manually switch between the input video sources by clicking this button
Auto Return	Yes	The card automatically switches back to the Primary source when it becomes available
	No	The card stays on the Backup source until the user manually switches the signal back to the Primary source
Return to Primary	Click this button to immediately switch back to the Primary source	
Output Setup		
Output Format	#	Selects the video format for the output signal. Note that a change in video format will not take effect until the reference is compatible

Table 29 Config Tab (Continued)

Item	Parameters	Description
Output Video Source	Video in	Specifies that the input video signal will be the output
	Test Pattern	Specifies that a SMPTE bars test pattern will replace all of the output picture (but not the HANC and VANC)
Horizontal Delay (percent of line)	#	Adjusts the horizontal delay with respect to the selected reference
Vertical Delay (lines)	#	Specifies the vertical delay with respect to the selected reference

Video Correction Tabs

The Video Correction options are organized into sub-tabs that provide options for color correction and conversion.

SDR/HDR Conversion Sub-tab

Table 30 summarizes the options displayed in the **SDR/HDR Conversion** sub-tab.

Table 30 Video Correction — SDR/HDR Conversion

Item	Parameters	Description
Status (read-only)	OK (Green)	UltraProc is enabled, the detected signal is valid, and the Bypass mode is set to Normal
	Input mismatch (Yellow)	A change in the Input > Colorimetry / Transfer Characteristics > Override setting is detected
	Rate Mismatch (Yellow)	The channel input signal data rate does not match the Config > Output Format
	Off (Gray)	UltraProc is disabled
Bypass	The card passes through the video input without modifications	
Normal	The card processes the video input through the Proc Amps, the SDR/HDR converter, and the RGB Color Corrector, and performs the target transform	
SDI Input > Colorimetry / Transfer Characteristics		
Detected (read-only)	Reports the dynamic range and colorimetry information from the SDI video input	

Table 30 Video Correction — SDR/HDR Conversion (Continued)

Item	Parameters	Description
Override	BT.709 SDR	HD colorimetry/transfer characteristics, Standard Dynamic Range
	BT.2020 SDR	UHD wide colorimetry/transfer characteristics, Standard Dynamic Range
	BT.2020 HLG	UHD wide colorimetry/transfer characteristics, Hybrid Log-Gamma dynamic range
	BT.2020 PQ	UHD wide colorimetry/transfer characteristics, Perceptual Quantizer dynamic range
	BT.2020 SLOG3	UHD wide colorimetry/transfer characteristics, Sony ® S-Log3 dynamic range
	BT.2020 SR Live	Wide color gamut recommended for UHD TV1 video signals, Sony® standard range
	Follow Detected	Automatically extracts the dynamic range and colorimetry information from the SDI video input 352M payload identifier and adjusts the SDR/HDR conversion accordingly
SDI Input > Proc Amp		
Black Offset (%)	#	Adjusts the Luma (Y) black offset of the SDI input streams
Gain (dB)	#	Adjusts the Luma and Chroma (Y/C) gain of the SDI input streams
Saturation	0 to 2.0	Adjusts the lightness of the input color
Hue Rotation (deg) ^a	-180 to +180	Adjusts the input hue level where: <ul style="list-style-type: none"> • increasing the hue rotation turns the color wheel clockwise • decreasing the hue rotation turns the color wheel counter-clockwise
SDI Output > Colorimetry / Transfer Characteristics		
Output	BT.709 SDR	HD colorimetry/transfer characteristics, Standard Dynamic Range
	BT.2020 SDR	UHD wide colorimetry/transfer characteristics, Standard Dynamic Range
	BT.2020 HLG	UHD wide colorimetry/transfer characteristics, Hybrid Log-Gamma dynamic range
	BT.2020 PQ	UHD wide colorimetry/transfer characteristics, Perceptual Quantizer dynamic range

Table 30 Video Correction — SDR/HDR Conversion (Continued)

Item	Parameters	Description
Output	BT.2020 SLOG3	UHD wide colorimetry/transfer characteristics, Sony ® S-Log3 dynamic range
	Follow Input	Automatically follows the dynamic range and colorimetry information as defined in the SDI Input area. In that case no SDR/HDR conversion is performed but the other video processing featured such as the Proc Amps and the RGB Color Correction are still available.
Output (read-only)	Reports the dynamic range and colorimetry information from the SDI video input	
SDI Output > Proc Amp		
Black Offset (%)	#	Adjusts the Luma (Y) black offset of the SDI output streams
Gain (dB)	#	Adjusts the Luma and Chroma (Y/C) gain of the SDI output streams
Saturation	0 to 2.0	Adjusts the lightness of the output color
Hue Rotation (deg) ^a	-180 to +180	Adjusts the output hue level where: <ul style="list-style-type: none"> • increasing the hue rotation turns the color wheel clockwise; • decreasing the hue rotation turns the color wheel counter-clockwise
Conversion > Tone Mapping		
Display Light	<p>Uses the EOTF of the SDI input dynamic range and colorimetry/transfer characteristics to convert the SDI input electrical signal to the Display Light units.</p> <p>Uses the inverse EOTF of the SDI output dynamic range and colorimetry/transfer characteristics to convert the Display Light units to the SDI output electrical signal.</p>	
Scene Light	<p>Uses the inverse EOTF of the SDI input dynamic range and colorimetry/transfer characteristics to convert the SDI input electrical signal to Scene Light units.</p> <p>Uses the EOTF of the SDI output dynamic range and colorimetry/transfer characteristics to convert the Scene Light units to the SDI output electrical signal</p>	
Direct Mapping, 1-to-1 No Scaling	Performs a straight conversion, without dynamic range compression or expansion, and without colorimetry/transfer characteristics compression or expansion	
Direct Mapping, BT.2408 Scaling	Performs a conversion as defined in ITU-BT.2408	
Conversion > RGB Cube File		

Table 30 Video Correction — SDR/HDR Conversion (Continued)

Item	Parameters	Description
Status (read-only)	Cube File Not Used (Green)	The Select File menu is set to [None]
	Unlicensed feature (Green)	The GATOR TOOLBOX+HDR-LUT license is not enabled. Refer to "Installing a License Key" for details.
	Valid file (Green)	The last cube file selected using the RGB Cube file menu is imported and valid
	Invalid file (Red)	An error occurred importing the last selected cube file. Verify that the file is in a supported format (*.cube)
Scan Files	Reads and list all the files found in the root directory and in the sub-directories, listing all the pre-loaded BBC and NBCU cube files libraries and any custom cube files already loaded by the user	
Select File	[None]	An RGB cube file is not currently loaded to the card
	<filename.cube>	Indicates the last cube file loaded to the card. Note that loading a RGB Cube File disables the DashBoard Tone Mapping options Display/Scene light and Direct/Tone Mapping Methods.
Range	Type I - Normal Range [64, 960]	Scales the SDI input signal level [64,940] to drive the 3D-LUT input processing range [0,1023] and will scale the 3D-LUT output processing range [0,1023] back to the SDI output signal level [64,940].
	Type III - Full Range [0,1023]	Drives the full 10-bit SDI input signal level directly to the 3D-LUT input processing range [0,1023] and will scale the 3D-LUT output processing range [0,1023] to the SDI output signal level [0,1023]
Output Clipping		
Y'	Normal [64,940]	Limits any processed luminance data to be between 64 and 940 in the active picture region of the video, coming out of the proc amp
	Super White [64,1019]	Limits any processed luminance data to be between 64 and 1019 in the active picture region of the video, coming out of the proc amp
	Super Black [4,940]	Limits any processed luminance data to be between 4 and 940 in the active picture region of the video, coming out of the proc amp
	Extended Luma [4,1019]	Limits any processed luminance data to be between 4 and 1019 in the active picture region of the video, coming out of the proc amp

Table 30 Video Correction — SDR/HDR Conversion (Continued)

Item	Parameters	Description
Cb'/Cr'	Normal [64,960]	Limits the gain of the blue color difference and the gain of the red color difference data to be between 64 and 960 in the active picture region of the video, coming out of the proc amp
	Wide Color [5,1019]	Limits the gain of the blue color difference and the gain of the red color difference data to be between 5 and 1019 in the active picture region of the video, coming out of the proc amp
Reset All	Returns all editable settings on the SDR/HDR Conversion sub-tab to the default values	

- a. This field is disabled and its value ignored when an RGB Cube File is in use.

Color Correction Sub-tab

Table 31 summarizes the options displayed in the **Color Correction** sub-tab.

Table 31 Video Correction — Color Correction

Item	Parameters	Description
RGB Color Correction		
RGB	Enables you to adjust the Red, Blue, and Green color components simultaneously	
R	Enables you to adjust the red color component independently of the other components	
G	Enables you to adjust the green color component independently of the other components	
B	Enables you to adjust the blue color component independently of the other components	
Gamma In	#	Applies a gamma function to the RGB' stream
Offset	#	Adjusts the black offset of the RGB' stream
Gain	#	Adjusts the gain of the RGB' stream
Lift	#	Lifts the black level of the RGB' stream, while applying a gain to keep the peak white at the same level
Inv. Gamma Out	#	Applies an inverse gamma function to the RGB' stream

Alarms Sub-tab

Table 32 summarizes the options displayed in the **Alarms** sub-tab.

Table 32 Video Correction — Alarms

Item	Parameters	Description
Bypass Alarm	Selected	Reports when the Normal/Bypass button, located in the top right corner of the Video Correction interface, is toggled to Bypass.
	Cleared	The status of the Normal/Bypass button is ignored
Input Mismatch Alarm	Selected	Reports when the SDR/HDR dynamic range and the BT.709 / BT.2020 colorimetry information decoded in the SDI video input does not match the SDI Input menu setting
	Cleared	The state of the input color settings are ignored
Cube File Alarm	Selected	Reports when there is a problem loading the user specified 33x33x33 3D-LUT RGB Cube File
	Cleared	The status of the cube file is ignored

Audio Tab

The Audio tab options are dependent on the GATOR model you have installed. There are two possible sub-tabs: Embedded and AES.

Embedded Sub-tab

Table 33 summarizes the options displayed in the Embedded sub-tab.

Table 33 Gator Toolbox # Interface — Audio > Embedded Tab

Item	Parameters	Description
Sample Rate Conversion	Selected	Applies the SRC on the audio channels in the video input before processed by the Frame Sync
	Cleared	SRC is not applied to any of the audio channels in the SDI input Select this option when using non-PCM audio data
Ch #		
Audio Source	Group # Ch #	Specifies the input for the specified channel that is inserted into the embedded pair (if present)
	#kHz Tone	Embeds the selected test tone

Table 33 Gator Toolbox # Interface — Audio > Embedded Tab (Continued)

Item	Parameters	Description
Mute	Selected	Mutes the input source for the specified channel that is inserted into the embedded pair (if present)
	Cleared	The input source for the specified channel is not muted
Gain (dB)	#	Adjusts the gain of the specified channel of audio Select 0 when using non-PCM audio
Gain Lock	Selected	Locks the Ch Gain slider for the specified channel pair
	Cleared	Unlocks the Ch Gain slider
Sum	Selected	Both channels will carry the average of the two input channels ((A+B)/2)
	Cleared	Disables this feature
Invert	Selected	Inverts the audio signal of the specified pair
	Cleared	<ul style="list-style-type: none"> • Audio signal of the specified pair is not inverted • Use for non-PCM audio data
Total Delay (ms) (read-only)	#	Reports the total delay applied to the specified channel
Delay Offset (ms)	#	Adjusts the delay of the specified channel
Delay Lock	Locks the Ch Delay slider for the specified channel pair	
Dolby E Metadata > Ch #		
Dolby Auto Align	Selected	<ul style="list-style-type: none"> • The Dolby E metadata on the audio signal of the specified channel is decoded, and embedded on the output with the Egress Line automatically adjusted as per Dolby specifications • The Mute, Gain, Sum, Invert, and Manual Delay settings on the Embed sub-tab are now disabled.
	Cleared	Disables this feature. This is the default.
Dolby Status (read-only)	Refer to Table 9 for a list of possible messages	
Egress Line (read-only)	#	Reports the line of the output signal that the Dolby E metadata is included on
Reset	Resets all Audio Output settings for the applicable audio pair to the factory default values	

AES Sub-tab

Table 34 summarizes the options displayed in the AES sub-tab.

★ This tab only displays when using an GATOR-4A or GATOR-4B.

Table 34 Gator Toolbox # Interface — Audio > AES Tab

Item	Parameters	Description
AES # - Channel #		
Audio Source	SDI# Ch #	Assigns the input for the specified channel
Mute	Selected	Mutes the input source for the specified channel
	Cleared	The input source for the specified channel is not muted
Gain (dB)	#	<ul style="list-style-type: none"> Adjusts the gain of the specified channel of audio Select 0 when using non-PCM audio
Gain Lock	Selected	Locks the Ch Gain slider for the specified pair
	Cleared	Unlocks the Ch Gain slider
Sum	Selected	Both channels will carry the average of the two input channels ((A+B)/2)
	Cleared	Disables this feature
Invert	Selected	Inverts the audio signal of the specified AES pair
	Cleared	<ul style="list-style-type: none"> Audio signal of the specified AES pair is not inverted Use for non-PCM audio data
Total Delay (ms) (read-only)	#	Reports the total delay applied to the specified AES channel
Delay Offset (ms)	#	Adjusts the delay of the specified AES channel
Delay Lock	Locks the Ch Delay slider for the specified AES channel pair	
Dolby E Metadata > Ch #		
Dolby Auto Align	Selected	<ul style="list-style-type: none"> The Dolby E metadata on the audio signal of the specified AES pair is decoded, and embedded on the output with the Egress Line automatically adjusted as per Dolby specifications The Mute, Gain, Sum, Invert, and Manual Delay settings on the AES sub-tab are now disabled.
	Cleared	Disables this feature. This is the default.
Dolby Status (read-only)	Refer to Table 9 for a list of possible messages	
Egress Line (read-only)	#	Reports the line of the output signal that the Dolby E metadata is included on
Reset	Resets all settings for the applicable AES pair to the factory default values	

ANC Tab

Table 35 summarizes the **ANC** options available in DashBoard.

Table 35 ANC Tab

Item	Parameters	Description
ST 352 Packet Insertion		
ST 352 Location	Off	Determines where to insert the SMPTE ST-352 packet in the output
	Luma Only	
	Chroma Only	
	Luma and Chroma	
ANC Frame Delay (read-only)	#	<ul style="list-style-type: none"> The frame delay is always relative to the next output frame. The ANC frame sync may operate with different input and output frame rates. The output is at a fixed rate as defined by the Output Video mode. When the output rate is lower than the input rate, then there is the potential for multiple inputs fields to be copied into the same output field. When the output rate is higher than the input rate, then there will be some output fields with no ANC data.
Packet Name (read-only)	#	Indicates the ancillary data type
Action	Delete	Card deletes the packet from the output
	Pass	<ul style="list-style-type: none"> The card receives and re-inserts the specified packet type into the specified line without modifying the packet contents This option is only applicable to packets that the card is not currently able to process
Insertion Line	Follow upstream	Uses the line detected in the input signal as the specified line to insert the ANC packet
	Switch Line + #	Selects a line to insert the specified ANC packet on. Note that if more than one packet is to be inserted in the same line, the packet with the lowest insertion order number will be inserted first.
	Process	Card receives the Closed Captioning CC-708 packet, processes it, and inserts a new packet into the specific line
Insertion Order	#	Defines the hierarchy of the packets insertion. Note that the lower the number, the higher priority the packet is given.

Format Converter Tab

Table 36 summarizes the options displayed in the Format Converter tab.

- ★ Two Format Converter tabs display (one for each Toolbox channel) when the card is operating in Dual Channel mode and a GATOR TOOLBOX+FRC license is installed for each channel.

Table 36 Format Converter Tab

Item	Parameters	Description
Format Converter Setup		
Cadence Detection	Disable	Disables this feature
	Enable*	Enables automatic 2:3 file cadence detection
SD Aspect Mode	Full screen	Select this option when the original SD input is 16:9 aspect ratio and you are up converting to 16:9 HD/3G/6G/12G
	Pillar box	Select this option when performing an 4:3 SD to 16:9 HD/3G/6G/12G up-conversion
	Letter box	Select this option when performing an 16:9 HD/3G/6G/12G to 4:3 SD down-conversion.
Detail Enhancement		
Vertical	#	Adjusts the horizontal and vertical frequency response of the scaler as required to enhance the image
Horizontal	#	

Technical Specifications

This chapter provides technical information for GATOR-TOOLBOX.

★ Specifications are subject to change without notice.

Supported Video Formats

Table 37 *Technical Specifications — Supported Video Formats*

Resolution (lines)	Frame Rate (Hz)
480i	59.94
	60
576i	50
720p	50
	59.94
	60
1080i	50
	59.94
	60
1080p	23.98
	24
	25
	29.97
	50
	59.94
	60
	60
1080pSF	23.98
	24
2160p	23.98
	24
	25
	29.97
	50
	59.94
	60

SDI Inputs Specifications

Table 38 Technical Specifications — SDI Inputs

Item	Specifications	
Number of Inputs (based on rear module)	8322AR-318D	4
	8322AR-319C	4
	8323AR-325	4
	8323AR-327 ^a	2 dedicated 3 bi-directional
Standards Accommodated	1.485Gbps SDI, SMPTE 292M	
	2.97Gbps SDI, SMPTE 424M	
	11.88Gbps SDI, SMPTE 2082	
Impedance	75ohm	
Return Loss	>15dB to 1.485Gbps	
	>10dB to 2.97Gbps	
	>4dB to 11.88Gbps	
Equalization (Belden 1694A cable)	>220m (722ft) @ 1.485Gbps	
	>140m (459ft) @ 2.97Gbps	
	>50m (190ft) @ 11.88Gbps	
Connector Type	8322AR-318D	HD-BNC
	8322AR-319C	HD-BNC
	8323AR-325	HD-BNC
	8323AR-327	HD-BNC and SFP

a. Refer to “Supported SFP Modules” for more specifications.

SDI Outputs Specifications

Table 39 Technical Specifications — SDI Outputs

Item	Specifications	
Number of Outputs (based on rear module)	8322AR-318D	4
	8322AR-319C	4
	8323AR-325	4
	8323AR-327 ^a	2 dedicated 3 bi-directional
Impedance	75ohm	
Return Loss	>15dB to 1.485Gbps	
	>10dB to 2.97Gbps	
	>4dB to 11.88Gbps	
Signal Level	800mV ±10%	
DC Offset	0V ±50mV	

Table 39 Technical Specifications — SDI Outputs (Continued)

Item	Specifications	
Rise and Fall Time (20-80%)	1.485Gbps: <270ps, <100ps difference	
	2.97Gbps: <135ps, <50ps difference	
	11.88Gbps: <45ps, <18ps difference	
Jitter	1.485Gbps: <1.0UI jitter measured 10Hz-100kHz, <0.2UI above 100kHz	
	2.97Gbps: <1.0UI jitter measured 10Hz-100kHz, <0.3UI above 100kHz	
	11.88Gbps: <2.0UI jitter measured 10Hz-100kHz, <0.3UI above 100kHz, band limit @1188MHz	
Overshoot	<10% (11.88Gbps: <15%)	
Connector Type	8322AR-318D	HD-BNC
	8322AR-319C	HD-BNC
	8323AR-325	HD-BNC
	8323AR-327	HD-BNC and SFP

a.Refer to “Supported SFP Modules” for more specifications.

AES Specifications

GATOR-4A

Table 40 Technical Specifications — GATOR-4A

Item	Specifications
AES Standards Accommodated	AES-3id-2001, AES3
Connector Type	HD-BNC
Inputs	
Impedance	75ohm
Minimum Input	50mV p-p
Maximum Input	2.5V p-p @ 48kHz
	1.5V p-p @ 96kHz
Minimum Audio Delay	SRC ON: 2ms
	SRC OFF: 1ms
Maximum Audio Delay	1365 ms
Sampling Rate	48kHz compliant with AES-3id or any rate from 32kHz to 96kHz with SRC on
Equalization	up to 800m (2,400ft) @ 48kHz
	up to 500m (1,500ft) @ 96kHz
Outputs	

Table 40 Technical Specifications — GATOR-4A (Continued)

Item	Specifications
Impedance	75ohm
Output Level	1V p-p
Sampling Rate	48kHz

GATOR-4B

Table 41 Technical Specifications — GATOR-4B

Item	Specifications
AES Standards Accommodated	AES-3id-2001, AES3
Connector Type	WECO
Impedance	110ohm
Minimum Input	100mV p-p
Maximum Input	10V p-p
Minimum Audio Delay	SRC ON: 2ms SRC OFF: 1ms
Maximum Audio Delay	1365 ms
Sampling Rate	48kHz compliant with AES-3id or any rate from 32kHz to 96kHz with SRC on
Equalization	>450m of Belden 1492 cable
Return Loss	>26dB 100KHz to 6MHz
Output Amplitude	4Vp-p
Rise and Fall Times	30ns
Jitter	4.5mUI

GPIO

Table 42 Technical Specifications — GPIO

Item	Specifications
Absolute Maximum Voltage at Connector Pins	1.0V to +6.0V to prevent damage
GPI	
Input	<ul style="list-style-type: none">• 4.7K ohm resistor pull-up to 5V for High• GND contact closure (or external logic) for Low• High In is $\geq 2.5V$• Low In is $\leq 0.5V$
Tally	
Output	<ul style="list-style-type: none">• Pulled to 5V with 4k7 ohm resistor for High• Driven to ground or Low through 30ohms• Maximum sink current 50mA to drive an external relay• To drive a logic gate input, sink current needs to be below 10mA (0.3V at pin)

Environment

Table 43 Technical Specifications — Environment

Item	Specifications
Maximum Ambient Temperature	40°C (104°F)

Power

Table 44 Technical Specifications — Power

Item	Specifications
Maximum Power Consumption	40W-80W (application dependent)

Supported SFP Modules

This chapter summarizes the supported SFP modules when using the GATOR-2F with the R4F-GATOR rear module.

SFP-FIBER-12G

The SFP-FIBER-12G is an optical transceiver module that supports data rates up to 12Gbps for single fiber communications.

Features

- SMPTE 297-2006 compatible for SD-SDI, HD-SDI, 3G-SDI, and 12G-SDI
- Compliant with SFP MSA (Small Form-Factor Pluggable Transceiver Multi-Source Agreement) and SFS-8472
- Compliant with SMPTE 297, SMPTE 259, SMPTE 292, SMPTE 424, SMPTE 2081, and SMPTE 2082
- 1310 DFB laser diode with CML logic interface
- Duplex LC receptacle
- Up to 10km on 9/125µm SMF
- Single 3.3V power supply
- Operating temperature range: 0°C to 70°C
- SFP package size: 56.5mm x 13.4mm x 8.6mm

Simplified Block Diagram

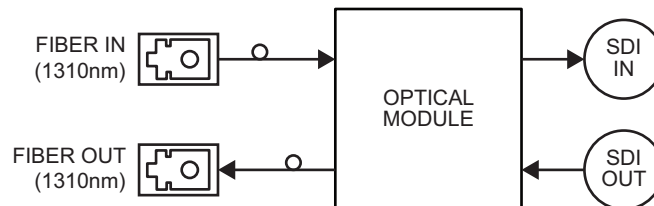

Figure 47 SFP-FIBER-12G — High Level Block Diagram

Technical Specifications

Note that specifications are subject to change without notice.

Absolute Maximum Ratings

Exceeding any of these ratings may permanently damage the module. Exposure to absolute maximum rating conditions for extended periods may affect device reliability.

Table 45 Absolute Maximum Ratings

Parameter	Min.	Max.
Supply Voltage	0V	+3.6V
Storage Temperature	-40°C	+85°C
Relative Humidity	5%	95%

Recommended Operating Environment and Electrical Ratings

Table 46 Recommended Ratings

Parameter	Min.	Typical	Max.
Supply Voltage	+3.2V	+3.3V	+3.4V
Supply Current	-	-	300mA
Operating Case Temperature	0°C		+70°C
Data Rate	-	11.88Gbps	-

Optical Specifications

Table 47 Optical Specifications — Transmitter

Parameter	Min.	Typical	Max.	Notes
Ambient Operating Temperature	Ta=+25±5°C C, VCC = 3.3±0.2V			
Data Rate			11.88Gbps	
Output Center Wavelength	1260nm	1310nm	1360nm	
Output Spectral Width (-20dB)			1nm	
Average Optical Output Power	-6dBm		0dBm	The optical power is launched into 9/125µm SMF
Extinction Ratio	3.5dB			

Table 48 Optical Specifications — Receiver

Parameter	Min.	Typical	Max.	Notes
Receiver Sensitivity			-11dBm	With a PRBS 223-1 test pattern @ 11.88Gbps
Maximum Input Power	-3dBm			
Operation Center Wavelength	1260nm		1360nm	
Loss of Signal	Assert	-25dBm		
	De-assert		-11dBm	
LOS Hysteresis	0.5dB			

Physical Channel Position

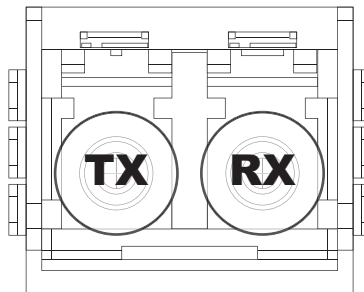

Figure 48 SFP Package Outline, Front View — Channel Position

Service Information

Routine maintenance to this product is not required. In the event of problems with your card, the following basic troubleshooting checklist may help identify the source of the problem. If the frame still does not appear to be working properly after checking all possible causes, please contact your openGear products distributor, or the Technical Support department at the numbers listed under the “**Contacting Technical Support**”.

1. **Visual Review** — Performing a quick visual check may reveal many problems, such as connectors not properly seated or loose cables. Check the card, the frame, and any associated peripheral equipment for signs of trouble.
2. **Power Check** — Inspect the power indicator LED on the distribution frame front panel for the presence of power. If the power LED is not illuminated, verify that the power cable is connected to a power source and that power is available at the power main. Confirm that the power supplies are fully seated in their slots. If the power LED is still not illuminated, replace the power supply with one that is verified to work.
3. **Input Signal Status** — Verify that source equipment is operating correctly and that a valid signal is being supplied.
4. **Output Signal Path** — Verify that destination equipment is operating correctly and receiving a valid signal.
5. **Unit Exchange** — Exchanging a suspect unit with a unit that is known to be working correctly is an efficient method for localizing problems to individual units.

Reloading the Software on the Card

In the unlikely event of a complete card failure, you may be instructed by a Ross Technical Support specialist to perform a complete software reload on the card.

To reload the software on the card

1. Eject the card from the frame.
2. Press and hold the **Bootload** button, while re-inserting the card into the frame.
3. Release the button.
 - If a new software load is not sent to the card within 60 seconds, the card will attempt to re-start with its last operational software load.
 - Software loads can be sent to the card via the connection on the rear of the frame.

Warranty and Repair Policy

The GATOR-TOOLBOX is warranted to be free of any defect with respect to performance, quality, reliability, and workmanship for a period of FIVE (5) years from the date of shipment from our factory. In the event that your card proves to be defective in any way during this warranty period, Ross Video Limited reserves the right to repair or replace this piece of equipment with a unit of equal or superior performance characteristics.

Should you find that this card has failed after your warranty period has expired, we will repair your defective product should suitable replacement components be available. You, the owner, will bear any labor and/or part costs incurred in the repair or refurbishment of said equipment beyond the FIVE (5) year warranty period.

In no event shall Ross Video Limited be liable for direct, indirect, special, incidental, or consequential damages (including loss of profits) incurred by the use of this product. Implied warranties are expressly limited to the duration of this warranty.

This User Manual provides all pertinent information for the safe installation and operation of your openGear product. Ross Video policy dictates that all repairs to the card are to be conducted only by an authorized Ross Video Limited factory representative. Therefore, any unauthorized attempt to repair this product, by anyone other than an authorized Ross Video Limited factory representative, will automatically void the warranty. Please contact Ross Video Technical Support for more information.

In Case of Problems

Should any problem arise with your card, please contact the Ross Video Technical Support Department. (Contact information is supplied at the end of this publication.)

A Return Material Authorization number (RMA) will be issued to you, as well as specific shipping instructions, should you wish our factory to repair your card. If required, a temporary replacement frame will be made available at a nominal charge. Any shipping costs incurred will be the responsibility of you, the customer. All products shipped to you from Ross Video Limited will be shipped collect.

The Ross Video Technical Support Department will continue to provide advice on any product manufactured by Ross Video Limited, beyond the warranty period without charge, for the life of the equipment.

Software Licenses

This chapter provides third-party software license information for your GATOR-TOOLBOX. This product includes multiple software components which are individually licensed under one or more of the following licenses included in this chapter.

BSD

Copyright (c) 1991,1993, The Regents of the University of California. All rights reserved.

This code is derived from software contributed to Berkeley by Kenneth Almquist.

Redistribution and use in source and binary forms, with or without modification, are permitted provided that the following conditions are met:

1. Redistributions of source code must retain the above copyright notice, this list of conditions and the following disclaimer.

2. Redistributions in binary form must reproduce the above copyright notice, this list of conditions and the following disclaimer in the documentation and/or other materials provided with the distribution.

3. <BSD Advertising Clause omitted per the July 22, 1999 licensing change ftp://ftp.cs.berkeley.edu/pub/4bsd/README.Impt.License.Change> California, Berkeley and its contributors.

4. Neither the name of the University nor the names of its contributors may be used to endorse or promote products derived from this software without specific prior written permission.

THIS SOFTWARE IS PROVIDED BY THE REGENTS AND CONTRIBUTORS "AS IS" AND ANY EXPRESS OR IMPLIED WARRANTIES, INCLUDING, BUT NOT LIMITED TO, THE IMPLIED WARRANTIES OF MERCHANTABILITY AND FITNESS FOR A PARTICULAR PURPOSE ARE DISCLAIMED. IN NO EVENT SHALL THE REGENTS OR CONTRIBUTORS BE LIABLE FOR ANY DIRECT, INDIRECT, INCIDENTAL, SPECIAL, EXEMPLARY, OR CONSEQUENTIAL DAMAGES (INCLUDING, BUT NOT LIMITED TO, PROCUREMENT OF SUBSTITUTE GOODS OR SERVICES; LOSS OF USE, DATA, OR PROFITS; OR BUSINESS INTERRUPTION) HOWEVER CAUSED AND ON ANY THEORY OF LIABILITY, WHETHER IN CONTRACT, STRICT LIABILITY, OR TORT (INCLUDING NEGLIGENCE OR OTHERWISE) ARISING IN ANY WAY OUT OF THE USE OF THIS SOFTWARE, EVEN IF ADVISED OF THE POSSIBILITY OF SUCH DAMAGE.

Dual GPL

Portions of this software are copyright (C) 1996-2002 The FreeType Project (www.freetype.org). All rights reserved.

This project is also covered under the GPL v2.

GPL

GNU GENERAL PUBLIC LICENSE

Version 3, 29 June 2007

Copyright (C) 2007 Free Software Foundation, Inc. <<http://fsf.org/>>

Preamble

The GNU General Public License is a free, copyleft license for software and other kinds of works.

The licenses for most software and other practical works are designed to take away your freedom to share and change the works. By contrast, the GNU General Public License is intended to guarantee your freedom to share and change all versions of a program—to make sure it remains free software for all its users. We, the Free Software Foundation, use the GNU General Public License for most of our software; it applies also to any other work released this way by its authors. You can apply it to your programs, too.

When we speak of free software, we are referring to freedom, not price. Our General Public Licenses are designed to make sure that you have the freedom to distribute copies of free software (and charge for them if you wish), that you receive source code or can get it if you want it, that you can change the software or use pieces of it in new free programs, and that you know you can do these things.

To protect your rights, we need to prevent others from denying you these rights or asking you to surrender the rights. Therefore, you have certain responsibilities if you distribute copies of the software, or if you modify it: responsibilities to respect the freedom of others.

For example, if you distribute copies of such a program, whether gratis or for a fee, you must pass on to the recipients the same freedoms that you received. You must make sure that they, too, receive or can get the source code. And you must show them these terms so they know their rights.

Developers that use the GNU GPL protect your rights with two steps: (1) assert copyright on the software, and (2) offer you this License giving you legal permission to copy, distribute and/or modify it.

For the developers' and authors' protection, the GPL clearly explains that there is no warranty for this free software. For both users' and authors' sake, the GPL requires that modified versions be marked as changed, so that their problems will not be attributed erroneously to authors of previous versions.

Some devices are designed to deny users access to install or run modified versions of the software inside them, although the manufacturer can do so. This is fundamentally incompatible with the aim of protecting users' freedom to change the software. The systematic pattern of such abuse occurs in the area of products for individuals to use, which is precisely where it is most unacceptable. Therefore, we have designed this version of the GPL to prohibit the practice for those products. If such problems arise substantially in other domains, we stand ready to extend this provision to those domains in future versions of the GPL, as needed to protect the freedom of users.

Finally, every program is threatened constantly by software patents. States should not allow patents to restrict development and use of software on general-purpose computers, but in those that do, we wish to avoid the special danger that patents applied to a free program could make it effectively proprietary. To prevent this, the GPL assures that patents cannot be used to render the program non-free.

The precise terms and conditions for copying, distribution and modification follow.

TERMS AND CONDITIONS

0. Definitions.

"This License" refers to version 3 of the GNU General Public License.

"Copyright" also means copyright-like laws that apply to other kinds of works, such as semiconductor masks.

"The Program" refers to any copyrightable work licensed under this License. Each licensee is addressed as "you". "Licensees" and "recipients" may be individuals or organizations.

To "modify" a work means to copy from or adapt all or part of the work in a fashion requiring copyright permission, other than the making of an exact copy. The resulting work is called a "modified version" of the earlier work or a work "based on" the earlier work.

A "covered work" means either the unmodified Program or a work based on the Program.

To "propagate" a work means to do anything with it that, without permission, would make you directly or secondarily liable for infringement under applicable copyright law, except executing it on a computer or modifying a private copy. Propagation includes copying, distribution (with or without modification), making available to the public, and in some countries other activities as well.

To "convey" a work means any kind of propagation that enables other parties to make or receive copies. Mere interaction with a user through a computer network, with no transfer of a copy, is not conveying.

An interactive user interface displays "Appropriate Legal Notices" to the extent that it includes a convenient and prominently visible feature that (1) displays an appropriate copyright notice, and (2) tells the user that there is no warranty for the work (except to the extent that warranties are provided), that licensees may convey the work under this License, and how to view a copy of this License. If the interface presents a list of user commands or options, such as a menu, a prominent item in the list meets this criterion.

1. Source Code.

The "source code" for a work means the preferred form of the work for making modifications to it. "Object code" means any non-source form of a work.

A "Standard Interface" means an interface that either is an official standard defined by a recognized standards body, or, in the case of interfaces specified for a particular programming language, one that is widely used among developers working in that language.

The "System Libraries" of an executable work include anything, other than the work as a whole, that (a) is included in the normal form of packaging a Major Component, but which is not part of that Major Component, and (b) serves only to enable use of the work with that Major Component, or to implement a Standard Interface for which an implementation is available to the public in source code form. A "Major Component", in this context, means a major essential component (kernel, window system, and so on) of the specific operating system (if any) on which the executable work runs, or a compiler used to produce the work, or an object code interpreter used to run it.

The "Corresponding Source" for a work in object code form means all the source code needed to generate, install, and (for an executable work) run the object code and to modify the work, including scripts to control those activities. However, it does not include the work's System Libraries, or general-purpose tools or generally available free programs which are used unmodified in performing those activities but which are not part of the work. For example, Corresponding Source includes interface definition files associated with source files for the work, and the source code for shared libraries and dynamically linked subprograms that the work is specifically designed to require, such as by intimate data communication or control flow between those subprograms and other parts of the work.

The Corresponding Source need not include anything that users can regenerate automatically from other parts of the Corresponding Source.

The Corresponding Source for a work in source code form is that same work.

2. Basic Permissions.

All rights granted under this License are granted for the term of copyright on the Program, and are irrevocable provided the stated conditions are met. This License explicitly affirms your unlimited permission to run the unmodified Program. The output from running a covered work is covered by this License only if the output, given its content, constitutes a covered work. This License acknowledges your rights of fair use or other equivalent, as provided by copyright law.

You may make, run and propagate covered works that you do not convey, without conditions so long as your license otherwise remains in force. You may convey covered works to others for the sole purpose of having them make modifications exclusively for you, or provide you with facilities for running those works, provided that you comply with the terms of this License in conveying all material for which you do not control copyright. Those thus making or running the covered works for you must do so exclusively on your behalf, under your direction and control, on terms that prohibit them from making any copies of your copyrighted material outside their relationship with you.

Conveying under any other circumstances is permitted solely under the conditions stated below. Sublicensing is not allowed; section 10 makes it unnecessary.

3. Protecting Users' Legal Rights From Anti-Circumvention Law.

No covered work shall be deemed part of an effective technological measure under any applicable law fulfilling obligations under article 11 of the WIPO copyright treaty adopted on 20 December 1996, or similar laws prohibiting or restricting circumvention of such measures.

When you convey a covered work, you waive any legal power to forbid circumvention of technological measures to the extent such circumvention is effected by exercising rights under this License with respect to the covered work, and you disclaim any intention to limit operation or modification of the work as a means of enforcing, against the work's users, your or third parties' legal rights to forbid circumvention of technological measures.

4. Conveying Verbatim Copies.

You may convey verbatim copies of the Program's source code as you receive it, in any medium, provided that you conspicuously and appropriately publish on each copy an appropriate copyright notice; keep intact all notices stating that this License and any non-permissive terms added in accord with section 7 apply to the code; keep intact all notices of the absence of any warranty; and give all recipients a copy of this License along with the Program.

You may charge any price or no price for each copy that you convey, and you may offer support or warranty protection for a fee.

5. Conveying Modified Source Versions.

You may convey a work based on the Program, or the modifications to produce it from the Program, in the form of source code under the terms of section 4, provided that you also meet all of these conditions:

- a. The work must carry prominent notices stating that you modified it, and giving a relevant date.
- b. The work must carry prominent notices stating that it is released under this License and any conditions added under section 7. This requirement modifies the requirement in section 4 to "keep intact all notices".
- c. You must license the entire work, as a whole, under this License to anyone who comes into possession of a copy. This License will therefore apply, along with any applicable section 7 additional terms, to the whole of the work, and all its parts, regardless of how they are packaged. This License gives no permission to license the work in any other way, but it does not invalidate such permission if you have separately received it.
- d. If the work has interactive user interfaces, each must display Appropriate Legal Notices; however, if the Program has interactive interfaces that do not display Appropriate Legal Notices, your work need not make them do so.

A compilation of a covered work with other separate and independent works, which are not by their nature extensions of the covered work, and which are not combined with it such as to form a larger program, in or on a volume of a storage or distribution medium, is called an "aggregate" if the compilation and its resulting copyright are not used to limit the access or legal rights of the compilation's users beyond what the individual works permit. Inclusion of a covered work in an aggregate does not cause this License to apply to the other parts of the aggregate.

6. Conveying Non-Source Forms.

You may convey a covered work in object code form under the terms of sections 4 and 5, provided that you also convey the machine-readable Corresponding Source under the terms of this License, in one of these ways:

- a. Convey the object code in, or embodied in, a physical product (including a physical distribution medium), accompanied by the Corresponding Source fixed on a durable physical medium customarily used for software interchange.
- b. Convey the object code in, or embodied in, a physical product (including a physical distribution medium), accompanied by a written offer, valid for at least three years and valid for as long as you offer spare parts or customer support for that product model, to give anyone who possesses the object code either (1) a copy of the Corresponding Source for all the software in the product that is covered by this License, on a durable physical medium customarily used for software interchange, for a price no more than your reasonable cost of physically performing this conveying of source, or (2) access to copy the Corresponding Source from a network server at no charge.
- c. Convey individual copies of the object code with a copy of the written offer to provide the Corresponding Source. This alternative is allowed only occasionally and noncommercially, and only if you received the object code with such an offer, in accord with subsection 6b.

- d. d) Convey the object code by offering access from a designated place (gratis or for a charge), and offer equivalent access to the Corresponding Source in the same way through the same place at no further charge. You need not require recipients to copy the Corresponding Source along with the object code. If the place to copy the object code is a network server, the Corresponding Source may be on a different server (operated by you or a third party) that supports equivalent copying facilities, provided you maintain clear directions next to the object code saying where to find the Corresponding Source. Regardless of what server hosts the Corresponding Source, you remain obligated to ensure that it is available for as long as needed to satisfy these requirements.
- e. e) Convey the object code using peer-to-peer transmission, provided you inform other peers where the object code and Corresponding Source of the work are being offered to the general public at no charge under subsection 6d.

A separable portion of the object code, whose source code is excluded from the Corresponding Source as a System Library, need not be included in conveying the object code work.

A "User Product" is either (1) a "consumer product", which means any tangible personal property which is normally used for personal, family, or household purposes, or (2) anything designed or sold for incorporation into a dwelling. In determining whether a product is a consumer product, doubtful cases shall be resolved in favor of coverage. For a particular product received by a particular user, "normally used" refers to a typical or common use of that class of product, regardless of the status of the particular user or of the way in which the particular user actually uses, or expects or is expected to use, the product. A product is a consumer product regardless of whether the product has substantial commercial, industrial or non-consumer uses, unless such uses represent the only significant mode of use of the product.

"Installation Information" for a User Product means any methods, procedures, authorization keys, or other information required to install and execute modified versions of a covered work in that User Product from a modified version of its Corresponding Source. The information must suffice to ensure that the continued functioning of the modified object code is in no case prevented or interfered with solely because modification has been made.

If you convey an object code work under this section in, or with, or specifically for use in, a User Product, and the conveying occurs as part of a transaction in which the right of possession and use of the User Product is transferred to the recipient in perpetuity or for a fixed term (regardless of how the transaction is characterized), the Corresponding Source conveyed under this section must be accompanied by the Installation Information. But this requirement does not apply if neither you nor any third party retains the ability to install modified object code on the User Product (for example, the work has been installed in ROM).

The requirement to provide Installation Information does not include a requirement to continue to provide support service, warranty, or updates for a work that has been modified or installed by the recipient, or for the User Product in which it has been modified or installed. Access to a network may be denied when the modification itself materially and adversely affects the operation of the network or violates the rules and protocols for communication across the network.

Corresponding Source conveyed, and Installation Information provided, in accord with this section must be in a format that is publicly documented (and with an implementation available to the public in source code form), and must require no special password or key for unpacking, reading or copying.

7. Additional Terms.

"Additional permissions" are terms that supplement the terms of this License by making exceptions from one or more of its conditions. Additional permissions that are applicable to the entire Program shall be treated as though they were included in this License, to the extent that they are valid under applicable law. If additional permissions apply only to part of the Program, that part may be used separately under those permissions, but the entire Program remains governed by this License without regard to the additional permissions.

When you convey a copy of a covered work, you may at your option remove any additional permissions from that copy, or from any part of it. (Additional permissions may be written to require their own removal in certain cases when you modify the work.) You may place additional permissions on material, added by you to a covered work, for which you have or can give appropriate copyright permission.

Notwithstanding any other provision of this License, for material you add to a covered work, you may (if authorized by the copyright holders of that material) supplement the terms of this License with terms:

- a. Disclaiming warranty or limiting liability differently from the terms of sections 15 and 16 of this License; or
- b. Requiring preservation of specified reasonable legal notices or author attributions in that material or in the Appropriate Legal Notices displayed by works containing it; or
- c. Prohibiting misrepresentation of the origin of that material, or requiring that modified versions of such material be marked in reasonable ways as different from the original version; or
- d. Limiting the use for publicity purposes of names of licensors or authors of the material; or
- e. Declining to grant rights under trademark law for use of some trade names, trademarks, or service marks; or
- f. Requiring indemnification of licensors and authors of that material by anyone who conveys the material (or modified versions of it) with contractual assumptions of liability to the recipient, for any liability that these contractual assumptions directly impose on those licensors and authors.

All other non-permissive additional terms are considered "further restrictions" within the meaning of section 10. If the Program as you received it, or any part of it, contains a notice stating that it is governed by this License along with a term that is a further restriction, you may remove that term. If a license document contains a further restriction but permits relicensing or conveying under this License, you may add to a covered work material governed by the terms of that license document, provided that the further restriction does not survive such relicensing or conveying.

If you add terms to a covered work in accord with this section, you must place, in the relevant source files, a statement of the additional terms that apply to those files, or a notice indicating where to find the applicable terms.

Additional terms, permissive or non-permissive, may be stated in the form of a separately written license, or stated as exceptions; the above requirements apply either way.

8. Termination.

You may not propagate or modify a covered work except as expressly provided under this License. Any attempt otherwise to propagate or modify it is void, and will automatically terminate your rights under this License (including any patent licenses granted under the third paragraph of section 11).

However, if you cease all violation of this License, then your license from a particular copyright holder is reinstated (a) provisionally, unless and until the copyright holder explicitly and finally terminates your license, and (b) permanently, if the copyright holder fails to notify you of the violation by some reasonable means prior to 60 days after the cessation.

Moreover, your license from a particular copyright holder is reinstated permanently if the copyright holder notifies you of the violation by some reasonable means, this is the first time you have received notice of violation of this License (for any work) from that copyright holder, and you cure the violation prior to 30 days after your receipt of the notice.

Termination of your rights under this section does not terminate the licenses of parties who have received copies or rights from you under this License. If your rights have been terminated and not permanently reinstated, you do not qualify to receive new licenses for the same material under section 10.

9. Acceptance Not Required for Having Copies.

You are not required to accept this License in order to receive or run a copy of the Program. Ancillary propagation of a covered work occurring solely as a consequence of using peer-to-peer transmission to receive a copy likewise does not require acceptance. However, nothing other than this License grants you permission to propagate or modify any covered work. These actions infringe copyright if you do not accept this License. Therefore, by modifying or propagating a covered work, you indicate your acceptance of this License to do so.

10. Automatic Licensing of Downstream Recipients.

Each time you convey a covered work, the recipient automatically receives a license from the original licensors, to run, modify and propagate that work, subject to this License. You are not responsible for enforcing compliance by third parties with this License.

An "entity transaction" is a transaction transferring control of an organization, or substantially all assets of one, or subdividing an organization, or merging organizations. If propagation of a covered work results from an entity transaction, each party to that transaction who receives a copy of the work also receives whatever

licenses to the work the party's predecessor in interest had or could give under the previous paragraph, plus a right to possession of the Corresponding Source of the work from the predecessor in interest, if the predecessor has it or can get it with reasonable efforts.

You may not impose any further restrictions on the exercise of the rights granted or affirmed under this License. For example, you may not impose a license fee, royalty, or other charge for exercise of rights granted under this License, and you may not initiate litigation (including a cross-claim or counterclaim in a lawsuit) alleging that any patent claim is infringed by making, using, selling, offering for sale, or importing the Program or any portion of it.

11. Patents.

A "contributor" is a copyright holder who authorizes use under this License of the Program or a work on which the Program is based. The work thus licensed is called the contributor's "contributor version".

A contributor's "essential patent claims" are all patent claims owned or controlled by the contributor, whether already acquired or hereafter acquired, that would be infringed by some manner, permitted by this License, of making, using, or selling its contributor version, but do not include claims that would be infringed only as a consequence of further modification of the contributor version. For purposes of this definition, "control" includes the right to grant patent sublicenses in a manner consistent with the requirements of this License.

Each contributor grants you a non-exclusive, worldwide, royalty-free patent license under the contributor's essential patent claims, to make, use, sell, offer for sale, import and otherwise run, modify and propagate the contents of its contributor version.

In the following three paragraphs, a "patent license" is any express agreement or commitment, however denominated, not to enforce a patent (such as an express permission to practice a patent or covenant not to sue for patent infringement). To "grant" such a patent license to a party means to make such an agreement or commitment not to enforce a patent against the party.

If you convey a covered work, knowingly relying on a patent license, and the Corresponding Source of the work is not available for anyone to copy, free of charge and under the terms of this License, through a publicly available network server or other readily accessible means, then you must either (1) cause the Corresponding Source to be so available, or (2) arrange to deprive yourself of the benefit of the patent license for this particular work, or (3) arrange, in a manner consistent with the requirements of this License, to extend the patent license to downstream recipients. "Knowingly relying" means you have actual knowledge that, but for the patent license, your conveying the covered work in a country, or your recipient's use of the covered work in a country, would infringe one or more identifiable patents in that country that you have reason to believe are valid.

If, pursuant to or in connection with a single transaction or arrangement, you convey, or propagate by procuring conveyance of, a covered work, and grant a patent license to some of the parties receiving the covered work authorizing them to use, propagate, modify or convey a specific copy of the covered work, then the patent license you grant is automatically extended to all recipients of the covered work and works based on it.

A patent license is "discriminatory" if it does not include within the scope of its coverage, prohibits the exercise of, or is conditioned on the non-exercise of one or more of the rights that are specifically granted under this License. You may not convey a covered work if you are a party to an arrangement with a third party that is in the business of distributing software, under which you make payment to the third party based on the extent of your activity of conveying the work, and under which the third party grants, to any of the parties who would receive the covered work from you, a discriminatory patent license (a) in connection with copies of the covered work conveyed by you (or copies made from those copies), or (b) primarily for and in connection with specific products or compilations that contain the covered work, unless you entered into that arrangement, or that patent license was granted, prior to 28 March 2007.

Nothing in this License shall be construed as excluding or limiting any implied license or other defenses to infringement that may otherwise be available to you under applicable patent law.

12. No Surrender of Others' Freedom.

If conditions are imposed on you (whether by court order, agreement or otherwise) that contradict the conditions of this License, they do not excuse you from the conditions of this License. If you cannot convey a covered work so as to satisfy simultaneously your obligations under this License and any other pertinent obligations, then as a consequence you may not convey it at all. For example, if you agree to terms that obligate you to collect a royalty for further conveying from those to whom you convey the Program, the only way you could satisfy both those terms and this License would be to refrain entirely from conveying the Program.

13. Use with the GNU Affero General Public License.

Notwithstanding any other provision of this License, you have permission to link or combine any covered work with a work licensed under version 3 of the GNU Affero General Public License into a single combined work, and to convey the resulting work. The terms of this License will continue to apply to the part which is the covered work, but the special requirements of the GNU Affero General Public License, section 13, concerning interaction through a network will apply to the combination as such.

14. Revised Versions of this License.

The Free Software Foundation may publish revised and/or new versions of the GNU General Public License from time to time. Such new versions will be similar in spirit to the present version, but may differ in detail to address new problems or concerns.

Each version is given a distinguishing version number. If the Program specifies that a certain numbered version of the GNU General Public License "or any later version" applies to it, you have the option of following the terms and conditions either of that numbered version or of any later version published by the Free Software Foundation. If the Program does not specify a version number of the GNU General Public License, you may choose any version ever published by the Free Software Foundation.

If the Program specifies that a proxy can decide which future versions of the GNU General Public License can be used, that proxy's public statement of acceptance of a version permanently authorizes you to choose that version for the Program.

Later license versions may give you additional or different permissions. However, no additional obligations are imposed on any author or copyright holder as a result of your choosing to follow a later version.

15. Disclaimer of Warranty.

THERE IS NO WARRANTY FOR THE PROGRAM, TO THE EXTENT PERMITTED BY APPLICABLE LAW. EXCEPT WHEN OTHERWISE STATED IN WRITING THE COPYRIGHT HOLDERS AND/OR OTHER PARTIES PROVIDE THE PROGRAM "AS IS" WITHOUT WARRANTY OF ANY KIND, EITHER EXPRESSED OR IMPLIED, INCLUDING, BUT NOT LIMITED TO, THE IMPLIED WARRANTIES OF MERCHANTABILITY AND FITNESS FOR A PARTICULAR PURPOSE. THE ENTIRE RISK AS TO THE QUALITY AND PERFORMANCE OF THE PROGRAM IS WITH YOU. SHOULD THE PROGRAM PROVE DEFECTIVE, YOU ASSUME THE COST OF ALL NECESSARY SERVICING, REPAIR OR CORRECTION.

16. Limitation of Liability.

IN NO EVENT UNLESS REQUIRED BY APPLICABLE LAW OR AGREED TO IN WRITING WILL ANY COPYRIGHT HOLDER, OR ANY OTHER PARTY WHO MODIFIES AND/OR CONVEYS THE PROGRAM AS PERMITTED ABOVE, BE LIABLE TO YOU FOR DAMAGES, INCLUDING ANY GENERAL, SPECIAL, INCIDENTAL OR CONSEQUENTIAL DAMAGES ARISING OUT OF THE USE OR INABILITY TO USE THE PROGRAM (INCLUDING BUT NOT LIMITED TO LOSS OF DATA OR DATA BEING RENDERED INACCURATE OR LOSSES SUSTAINED BY YOU OR THIRD PARTIES OR A FAILURE OF THE PROGRAM TO OPERATE WITH ANY OTHER PROGRAMS), EVEN IF SUCH HOLDER OR OTHER PARTY HAS BEEN ADVISED OF THE POSSIBILITY OF SUCH DAMAGES.

17. Interpretation of Sections 15 and 16.

If the disclaimer of warranty and limitation of liability provided above cannot be given local legal effect according to their terms, reviewing courts shall apply local law that most closely approximates an absolute waiver of all civil liability in connection with the Program, unless a warranty or assumption of liability accompanies a copy of the Program in return for a fee.

LGPL

GNU LESSER GENERAL PUBLIC LICENSE
Version 3, 29 June 2007

Copyright (C) 2007 Free Software Foundation, Inc. <<http://fsf.org/>>

Everyone is permitted to copy and distribute verbatim copies of this license document, but changing it is not allowed.

This version of the GNU Lesser General Public License incorporates the terms and conditions of version 3 of the GNU General Public License, supplemented by the additional permissions listed below.

0. Additional Definitions.

As used herein, "this License" refers to version 3 of the GNU Lesser General Public License, and the "GNU GPL" refers to version 3 of the GNU General Public License.

"The Library" refers to a covered work governed by this License, other than an Application or a Combined Work as defined below.

An "Application" is any work that makes use of an interface provided by the Library, but which is not otherwise based on the Library. Defining a subclass of a class defined by the Library is deemed a mode of using an interface provided by the Library.

A "Combined Work" is a work produced by combining or linking an Application with the Library. The particular version of the Library with which the Combined Work was made is also called the "Linked Version".

The "Minimal Corresponding Source" for a Combined Work means the Corresponding Source for the Combined Work, excluding any source code for portions of the Combined Work that, considered in isolation, are based on the Application, and not on the Linked Version.

The "Corresponding Application Code" for a Combined Work means the object code and/or source code for the Application, including any data and utility programs needed for reproducing the Combined Work from the Application, but excluding the System Libraries of the Combined Work.

1. Exception to Section 3 of the GNU GPL.

You may convey a covered work under sections 3 and 4 of this License without being bound by section 3 of the GNU GPL.

2. Conveying Modified Versions.

If you modify a copy of the Library, and, in your modifications, a facility refers to a function or data to be supplied by an Application that uses the facility (other than as an argument passed when the facility is invoked), then you may convey a copy of the modified version:

- a. under this License, provided that you make a good faith effort to ensure that, in the event an Application does not supply the function or data, the facility still operates, and performs whatever part of its purpose remains meaningful, or
- b. under the GNU GPL, with none of the additional permissions of this License applicable to that copy.

3. Object Code Incorporating Material from Library Header Files.

The object code form of an Application may incorporate material from a header file that is part of the Library. You may convey such object code under terms of your choice, provided that, if the incorporated material is not limited to numerical parameters, data structure layouts and accessors, or small macros, inline functions and templates (ten or fewer lines in length), you do both of the following:

- a. Give prominent notice with each copy of the object code that the Library is used in it and that the Library and its use are covered by this License.
- b. Accompany the object code with a copy of the GNU GPL and this license document.

4. Combined Works.

You may convey a Combined Work under terms of your choice that, taken together, effectively do not restrict modification of the portions of the Library contained in the Combined Work and reverse engineering for debugging such modifications, if you also do each of the following:

- a. Give prominent notice with each copy of the Combined Work that the Library is used in it and that the Library and its use are covered by this License.
- b. Accompany the Combined Work with a copy of the GNU GPL and this license document.
- c. For a Combined Work that displays copyright notices during execution, include the copyright notice for the Library among these notices, as well as a reference directing the user to the copies of the GNU GPL and this license document.
- d. Do one of the following:
 - 1) Convey the Minimal Corresponding Source under the terms of this License, and the Corresponding Application Code in a form suitable for, and under terms that permit, the user to recombine or relink the Application with a modified version of the Linked Version to produce a modified Combined Work, in the manner specified by section 6 of the GNU GPL for conveying Corresponding Source.
 - 2) Use a suitable shared library mechanism for linking with the Library. A suitable mechanism is one that (a) uses at run time a copy of the Library already present on the user's computer system, and (b) will operate properly with a modified version of the Library that is interface-compatible with the Linked Version.
- e. Provide Installation Information, but only if you would otherwise be required to provide such information under section 6 of the GNU GPL, and only to the extent that such information is necessary to install and execute a modified version of the Combined Work produced by recombining or relinking the Application with a modified version of the Linked Version. (If you use option 4d0, the Installation Information must accompany the Minimal Corresponding Source and Corresponding Application Code. If you use option 4d1, you must provide the Installation Information in the manner specified by section 6 of the GNU GPL for conveying Corresponding Source.)

5. Combined Libraries.

You may place library facilities that are a work based on the Library side by side in a single library together with other library facilities that are not Applications and are not covered by this License, and convey such a combined library under terms of your choice, if you do both of the following:

- a. Accompany the combined library with a copy of the same work based on the Library, uncombined with any other library facilities, conveyed under the terms of this License.
- b. Give prominent notice with the combined library that part of it is a work based on the Library, and explaining where to find the accompanying uncombined form of the same work.

6. Revised Versions of the GNU Lesser General Public License.

The Free Software Foundation may publish revised and/or new versions of the GNU Lesser General Public License from time to time. Such new versions will be similar in spirit to the present version, but may differ in detail to address new problems or concerns.

Each version is given a distinguishing version number. If the Library as you received it specifies that a certain numbered version of the GNU Lesser General Public License "or any later version" applies to it, you have the option of following the terms and conditions either of that published version or of any later version published by the Free Software Foundation. If the Library as you received it does not specify a version number of the GNU Lesser General Public License, you may choose any version of the GNU Lesser General Public License ever published by the Free Software Foundation.

If the Library as you received it specifies that a proxy can decide whether future versions of the GNU Lesser General Public License shall apply, that proxy's public statement of acceptance of any version is permanent authorization for you to choose that version for the Library.

MIT

Copyright 1987, 1988 by MIT Student Information Processing Board.

Permission to use, copy, modify, and distribute this software and its documentation for any purpose is hereby granted, provided that the names of M.I.T. and the M.I.T. S.I.P.B. not be used in advertising or publicity pertaining to distribution of the software without specific, written prior permission. M.I.T. and the M.I.T. S.I.P.B. make no representations about the suitability of this software for any purpose. It is provided "as is" without express or implied warranty.

zlib

Copyright (C) 1995-1998 Jean-loup Gailly and Mark Adler

This software is provided 'as-is', without any express or implied warranty. In no event will the authors be held liable for any damages arising from the use of this software.

Permission is granted to anyone to use this software for any purpose, including commercial applications, and to alter it and redistribute it freely, subject to the following restrictions:

1. The origin of this software must not be misrepresented; you must not claim that you wrote the original software. If you use this software in a product, an acknowledgment in the product documentation would be appreciated but is not required.
2. Altered source versions must be plainly marked as such, and must not be misrepresented as being the original software.
3. This notice may not be removed or altered from any source distribution. Jean-loup Gailly Mark Adler jloup@gzip.org madler@alumni.caltech.edu

The data format used by the zlib library is described by RFCs (Request for Comments) 1950 to 1952 in the files <ftp://ds.internic.net/rfc/rfc1950.txt> (zlib format), [rfc1951.txt](ftp://ds.internic.net/rfc/rfc1951.txt) (deflate format) and [rfc1952.txt](ftp://ds.internic.net/rfc/rfc1952.txt) (gzip format).

Glossary

The following terms are used throughout this guide:

Active image — the portion of the video picture area (production aperture) that is being utilized for output content. Active image excludes letterbox bars and pillarbox bars.

Card — openGear terminal device within openGear frames, including all components and switches.

CBR — constant bit rate

DashBoard — the DashBoard Control System

DTVCC captions — CEA-708 captions

EETF — Electrical Y'CbCr to Electrical Y'CbCr Transfer Function

EOTF — Electrical Y'CbCr to Optical display light Cd/m² Transfer Function

Frame — the openGear frame that houses the GATOR-TOOLBOX.

HTTP — Direct Hypertext Transfer Protocol

MIB — management information base

Network Controller Card — the MFC-OG3-N and any available options unless otherwise noted.

NTSC captions — the CEA-608-D: Line 21 Data Services captions.

OETF — Optical scene light Cd/m² to Electrical Y'CbCr Transfer Function

OOTF — Optical Cd/m² to Optical Cd/m² Transfer Function

openGear frame — refers to the OGX-FR series frames unless otherwise noted.

PAL — PAL-B and PAL-G unless otherwise stated.

Production aperture — the image lattice that represents the maximum possible image extent in a given standard (e.g. the full size of all active pixels and active lines). For example, the 1080i production aperture would be 1920x1080.

System — the mix of interconnected production and terminal equipment in your environment.

TCP — Transmission Control Protocol.

User — the person who uses the GATOR-TOOLBOX.

