



# SmartShell User Guide

(shotbox mode edition)

for software version 7.3a

# Thank You for Choosing Ross

You've made a great choice. We expect you will be very happy with your purchase of Ross Technology.

Our mission is to:

1. Provide a Superior Customer Experience
  - offer the best product quality and support
2. Make Cool Practical Technology
  - develop great products that customers love

Ross has become well known for the Ross Video Code of Ethics. It guides our interactions and empowers our employees. I hope you enjoy reading it below.

If anything at all with your Ross experience does not live up to your expectations be sure to reach out to us at [solutions@rossvideo.com](mailto:solutions@rossvideo.com).



David Ross  
CEO, Ross Video  
[dross@rossvideo.com](mailto:dross@rossvideo.com)

## Ross Video Code of Ethics

Any company is the sum total of the people that make things happen. At Ross, our employees are a special group. Our employees truly care about doing a great job and delivering a high quality customer experience every day. This code of ethics hangs on the wall of all Ross Video locations to guide our behavior:

1. We will always act in our customers' best interest.
2. We will do our best to understand our customers' requirements.
3. We will not ship crap.
4. We will be great to work with.
5. We will do something extra for our customers, as an apology, when something big goes wrong and it's our fault.
6. We will keep our promises.
7. We will treat the competition with respect.
8. We will cooperate with and help other friendly companies.
9. We will go above and beyond in times of crisis. *If there's no one to authorize the required action in times of company or customer crisis - do what you know in your heart is right. (You may rent helicopters if necessary.)*

# SmartShell User Guide

- Ross Part Number: **5100DR-002-7.3A**.
- Publication Date: April 10, 2025. Printed in Canada.
- Software Version: 7.3a (may also apply to later versions)

## Copyright

©2025 Ross Video Limited, Ross®, and any related marks are trademarks or registered trademarks of Ross Video Limited. All other trademarks are the property of their respective companies. PATENTS ISSUED and PENDING. All rights reserved. No part of this publication may be reproduced, stored in a retrieval system, or transmitted in any form or by any means, mechanical, photocopying, recording or otherwise, without the prior written permission of Ross Video. While every precaution has been taken in the preparation of this document, Ross Video assumes no responsibility for errors or omissions. Neither is any liability assumed for damages resulting from the use of the information contained herein.

## Patents

Ross Video products are protected by patent numbers US 7802802; US 7602446; US 7508455; US 8307284; US 7834886; US 8519949; US 7034886; US 7914332; US 8499019; US 8407374; US 8743292; US 9710879; US 9558595; US D752530; US 9444237; US 9615187; US 9751213; US 9727313; CAN 2937964; US 9781358; US 9887859; US 9799973; GB 2419119; GB 2447380. Other patents pending.

## Company Address and Contact Information



**Ross Video Limited**  
8 John Street  
Iroquois, Ontario  
Canada, K0E 1K0

**Ross Video Incorporated**  
P.O. Box 880  
Ogdensburg, New York  
USA 13669-0880

General Business Office: (+1) 613 • 652 • 4886

Fax: (+1) 613 • 652 • 4425

Toll Free Technical Support: 1-844-652-0645 (North America)  
+800 1005 0100 (International)

Technical Support: (+1) 613 • 652 • 4886

E-mail for Technical Support: [techsupport@rossvideo.com](mailto:techsupport@rossvideo.com)

ROSS VIDEO | HELP CENTER: <https://support.rossvideo.com/hc/en-us>

E-mail for General Information: [solutions@rossvideo.com](mailto:solutions@rossvideo.com)

Ross Video Website: <http://www.rossvideo.com>

# Contents

<b>Welcome</b>	<b>6</b>
Documentation Conventions .....	6
Contacting Technical Support .....	7
Important Safety Notices .....	8
<b>SmartShell Overview</b>	<b>10</b>
SmartShell User Interface .....	10
Starting the Ross Robotics System .....	19
Selecting a Camera System to Control .....	22
Working with Camera Groups .....	22
<b>Presets</b>	<b>25</b>
Preset Panel Icons .....	25
Preset Categories .....	26
Add a Preset .....	29
Edit a Preset .....	31
Clone a Preset .....	37
Update a Preset Position .....	37
Delete a Preset .....	38
Recall a Preset .....	38
Alternative Cue/Cut Speed .....	42
About CamBot XY Pedestals: Base Rotation, Panning, and Presets .....	44
<b>Moves</b>	<b>49</b>
Understanding Moves .....	49
Moves Panel Icons .....	50
Move Categories .....	51
Create a Move .....	54
Create a Keyframe by Dragging a Preset into a Move .....	55
Create a Keyframe Dynamically .....	57
Edit a Keyframe .....	60
Delete a Keyframe .....	62
Record Axis Movement .....	63
Enabling and Disabling Preset Data for Individual Axes within a Keyframe .....	64
Clone a Move .....	65
Edit a Move .....	65
Create a Looped Move .....	66
Verify and Correct a Move .....	67
Cue and Run a Move .....	70
Delete a Move .....	71
Encountering an XY (floor) Limit During Move Recall .....	72
Cueing Dolly Moves with Unreachable Track Start Position .....	73
<b>Locking Presets and Moves</b>	<b>74</b>
<b>The Matrix View</b>	<b>75</b>
Access the Matrix View .....	76
Using Matrix Buttons .....	76
Assign an Action to a Matrix Button .....	77
Creating and Editing Macros .....	78

Create a New Preset Action on a Matrix Button .....	82
Edit a Matrix Button (Preset or Move) .....	85
Reposition Matrix Buttons .....	88
Deleting a Matrix Button .....	88
Create a New Page of Matrix Buttons .....	88
Navigate Between Pages of Matrix Buttons .....	88
Select a Camera for Joystick Control .....	89
Create a New Matrix .....	89
Save a Matrix File .....	89
Load a Matrix File .....	89
<b>The Joystick Panel</b> .....	<b>90</b>
Control Precedence .....	90
Joystick Panel Controls .....	91
Joystick Control Settings .....	101
<b>Axis Configuration</b> .....	<b>121</b>
Select an Axis to Configure .....	121
View the Current Axis Position Value and Status .....	122
Configure Camera Response to Manual Controls .....	122
View and Set Temporary Axis Limits .....	124
Handling Beyond Limits State on XY Axis .....	131
Joystick Control Confirmation .....	132
Targeting XY Pedestals .....	134
Overriding the Furio Collision Avoidance System .....	136
<b>Manual Operation in SmartShell</b> .....	<b>139</b>
Control Precedence .....	139
Operate a Camera Manually (Axis Jog Mode) .....	140
Using Quick Focus to Fine-Tune the Focus .....	141
Aligning, Trucking, and Dollying XY Pedestals .....	142
Standard Steering and Pan-Relative Steering for XY Pedestals .....	143
<b>CamBot Local Control Box</b> .....	<b>144</b>
Switching Between Remote Control and Local Control .....	145
Moving the Pedestal Across the Studio Floor .....	146
Raising and Lowering the Lift Column .....	146
Panning and Tilting the Head .....	147
Adjusting Drag for Pan and/or Tilt .....	147
Locking and Unlocking Tilt and/or Pan .....	148
Rotating the Pedestal Base .....	148
<b>Notifications Window</b> .....	<b>149</b>
<b>Glossary</b> .....	<b>151</b>

# Welcome

This is the User Guide for Ross Robotics SmartShell software. SmartShell is a graphical user interface (GUI) for controlling and programming your Ross Video robotics system. This User Guide describes SmartShell and how to use it to operate your robotics system.

## Control Modes

The SmartShell interface is set up to operate in one of two control modes; panel mode or shot box mode. Full functionality is available in either mode. The main difference between the modes is the order in which you tap objects in the interface.

This edition of the SmartShell User Guide is written for panel mode. In panel mode, you generally tap the item you want to affect, and then tap the action you want to apply to it.

To determine which mode your SmartShell computer uses, tap the **Help** button (?). In the **Welcome** topic, the **Control Modes** section indicates the current control mode.

**Note:** The control mode is set during system commissioning. For more information, contact Ross Video technical support.

## Documentation Conventions

### Text Format Conventions

Special text formats are used in this User Guide to identify parts of the user interface, text that a user must enter, or a sequence of menus and submenus that must be followed to reach a particular command.

Text Format	Meaning
<b>Bold text</b>	Bold text is used to identify a user interface element such as a dialog box, menu item, or button. For example: In the <b>Presets</b> panel, tap <b>ADD</b> .
Courier text	Courier text is used to identify text that a user must type. For example: In the address bar, type <code>localhost</code> and press <b>Enter</b> .
<i>Italic text</i>	Italic text is used to identify the titles of referenced guides, manuals, or documents. For example: For more information, refer to the <i><b>SmartShell Computer Quick Start Guide</b></i> .
>	Menu arrows are used in procedures to identify a sequence of menu items that you must follow. For example, if a step reads " <b>Display &gt; Widgets</b> ," you would tap the <b>Display</b> menu and then tap <b>Widgets</b> .

## User Interface Conventions

You can interact with SmartShell using a touch screen and/or a keyboard and mouse. The instructions in this User Guide describe how to interact with SmartShell using a touch screen. The following table provides equivalent actions for using a keyboard and mouse.

Instruction	Touch Screen	Keyboard and Mouse
tap	Tap the object briefly.	Click the object. Click refers to pressing the left mouse button briefly. Right-click refers to pressing the right mouse button briefly.
touch and hold	Touch the object and hold your finger on it until a circle appears, and then release it.	Right-click and hold your finger on the mouse button until the expected action occurs.
drag	Touch the object, hold your finger on it, and drag your finger on the screen to move the object.	Click and drag the object.

## Contacting Technical Support

At Ross Video, we take pride in the quality of our products, but if problems occur, help is as close as the nearest telephone.

Our 24-hour Hot Line service ensures you have access to technical expertise around the clock. After-sales service and technical support is provided directly by Ross Video personnel. During business hours (Eastern time), technical support personnel are available by telephone any time. After hours and on weekends, a direct emergency technical support phone line is available. If the technical support person who is on call does not answer this line immediately, a voice message can be left and the call will be returned shortly. This team of highly trained staff is available to react to any problem and to do whatever is necessary to ensure customer satisfaction.

- **Technical Support:** (+1) 613-652-4886
- **After Hours Emergency:** (+1) 613-349-0006
- **Technical Support (Toll Free):**
  - › **North America:** 1-844-652-0645
  - › **International:** +800 1005 0100
- **E-mail:** [techsupport@rossvideo.com](mailto:techsupport@rossvideo.com)
- **Ross Video HELP CENTER:** <https://support.rossvideo.com/hc/en-us>
- **Ross Video Website:** <http://www.rossvideo.com>

## Korean Class A Notice

The following is the Korean Class A Broadcasting and Telecommunication Products for Business Purpose Statement.

이 기기는 업무용(A급) 전자파적합기기로서 판매자 또는 사용자는 이 점을 주의하시기 바라며, 가정외의 지역에서 사용하는 것을 목적으로 합니다.









The preceding statement applies to the following Ross Video components, and may also apply to others:

- **5100AR-252-01** — 6-Axis Unified Robotics Control Panel

- **5100AR-825-01** — CamBot AGNOSTIC S3 Pedestal
- **5100AR-826-01** — CamBot 600XY S2 Pedestal

## Important Safety Notices

The following table contains important notices and safety instructions. Before using this product and any associated equipment, read and keep these notices and instructions. Heed all warnings and follow all safety instructions.

 <b>Caution</b>	<p>This equipment must be operated by trained personnel only.</p> <p>This equipment must be operated in a controlled and restricted environment only.</p>
 <b>Warning</b>	<p>The safe operation of this product requires that a protective earth connection be provided. A grounding conductor in the equipment's supply cord provides this protective earth. To reduce the risk of electrical shock to the operator and service personnel, this ground conductor must be connected to an earthed ground.</p> <p>Use only power cords specified for this product and certified for the country of use.</p> <p>Do not defeat safety purpose of the grounding-type plug. A grounding type plug has two blades and a third grounding prong. The third prong is provided for your safety. If the provided plug does not fit in to your outlet, consult an electrician for replacement of the obsolete outlet.</p> <p>Protect power cord from being walked on or pinched, particularly at plugs, convenience receptacles, and points where they exit from the apparatus.</p>
 <b>ESD</b>	<p><b>ESD Susceptibility</b> — This symbol on the equipment or within the equipment manual indicates that an electrical or electronic device or assembly is susceptible to damage from an ESD event.</p>
 <b>Warning</b>	<p><b>Hazardous Voltages</b> — This symbol on the equipment or within the equipment manual indicates the presence of uninsulated “dangerous voltage” within the product enclosure that may be of sufficient magnitude to constitute a risk of shock to persons.</p>
 <b>Warning</b>	<p>Indoor Use: “WARNING – TO REDUCE THE RISK OF FIRE OR ELECTRIC SHOCK, DO NOT EXPOSE THIS APPARATUS TO RAIN OR MOISTURE”</p> <p>Do not use this apparatus near water.</p> <p>Do not block any ventilation openings. Install in accordance with manufacturer's instructions.</p> <p>Do not install near heat sources such as radiators, heat registers, stoves, or other apparatus (including amplifiers) that produce heat.</p> <p>Only use attachments/accessories specified by the manufacturer.</p> <p>Unplug this apparatus during lightning storms or when unused for long periods of time.</p> <p>Clean only with a dry cloth.</p>
 <b>Warning</b>	<p>Refer all servicing to qualified personnel. Servicing is required when the apparatus has been damaged in any way, such as power-supply cord or plug damage, liquid has been spilled or objects have fallen into the apparatus, the apparatus has been exposed to rain or moisture, does not operate normally, or has been dropped.</p>
 <b>Warning</b>	<p>To reduce the risk of fire, replacement fuses must be the same type and rating.</p>
 <b>Warning</b>	<p>This product contains safety critical parts, which if incorrectly replaced may present a risk of fire or electrical shock. Components contained within the product's power supplies and power supply area are not customer-serviceable and should be returned to the factory for repair.</p>

	<b>Caution</b>	Ensure that proper cable management techniques are used at all times. Bundle and wrap cables neatly, and provide adequate strain relief and slack where necessary. Test your cable installation by moving the robotic units through their entire range of motion and observing the cables, to ensure that they do not become taut, or snag on anything. Avoid running cables along floors in places where they may present a tripping hazard. Clearly mark areas where cables may present a tripping hazard, and keep personnel away from such areas. Inspect cables periodically for damage, and to ensure that proper cable management is maintained.
	<b>Warning</b>	Damaged or improper cables may cause electric shock and/or fire. Ensure that all cables and connectors are of suitable type for their purpose, and that all power cable conductors are of adequate gauge for the voltage and current required. Inspect all cables periodically to check for damage. If a cable becomes damaged, turn off power to the system immediately, and then replace the damaged cable.
	<b>Warning</b>	<p>Serious injuries can result from people tripping over equipment, such as cables and dolly rails. Methods of reducing such risks include, but are not limited to, the following:</p> <ul style="list-style-type: none"> <li>• Erecting signs at studio entrances to remind people about tripping hazards and other studio hazards.</li> <li>• Training personnel about safety procedures and proper cable management techniques.</li> <li>• Showing personnel and guests the locations of cables and rails, and explaining that robotic cameras and cables attached to them may move at any time.</li> <li>• Escorting guests at all times while in the studio.</li> <li>• Ensuring adequate lighting when working in the studio.</li> <li>• Marking safe paths and/or restricted areas, to keep people away from moving robots and potential tripping hazards.</li> </ul>
	<b>Caution</b>	Loose or overtightened bolts may cause equipment damage. When servicing, tighten bolts to specified torque.
	<b>Warning</b>	Moving parts may present a pinching hazard. Keep all personnel away from robots when they are operational. When a robotic head or robotic lift column moves, fingers touching or near the unit or the payload may become pinched. When installing or adjusting the payload, ensure that power to the system is turned off. When operating a robotic pedestal locally, touch only the pan bars and the local control unit.
	<b>Warning</b>	When servicing or moving equipment, always observe safe handling practices. Get help to move heavy items. Use safe lifting techniques. Follow all safety rules of your workplace.
	<b>Caution</b>	Loose payloads may slip, causing equipment damage and injury. Periodically check all bolts that fasten the payload, to ensure that they are tightened to specified torque. If the payload is loose or slips, ensure that it is properly balanced and fastened before operating the robot.
	<b>Warning</b>	Improper mounting may cause equipment damage and serious injury. When mounting a robotic head to a wall, use an approved mounting bracket. Use fasteners that are rated for the total load, and are suitable for the material to which they are being fastened. Install safety chains to ensure that the load does not fall if the mount fails. Ensure that the wall is sturdy and capable of supporting the total load. Ensure that the wall is immobile and that it will not move when the robotic head moves.
	<b>Caution</b>	Imbalanced payloads may cause equipment damage and may present a tipping hazard. Ensure payloads are properly balanced. If you adjust a payload, always rebalance it.

# SmartShell Overview

SmartShell is a graphical user interface (GUI) for operating your Ross Video robotics system. SmartShell enables you to control robotic camera systems (cameras) automatically using presets and move sequences, and manually using a joystick panel and/or buttons in the user interface. The standard SmartShell computer comes with a touch screen monitor. You can also use the provided mouse and keyboard.

SmartShell controls Ross Video robots (Furio and CamBot), and select robots from other manufacturers. For more information about which third-party robots are supported, contact Ross Video.

The following sections contain information to help you learn about SmartShell and start using it:

- “**SmartShell User Interface**” on [page 10](#)
- “**Starting the Ross Robotics System**” on [page 19](#)
- “**Selecting a Camera System to Control**” on [page 22](#)

**Tip:** For definitions of technical terms, see “**Glossary**” on [page 141](#)

## SmartShell User Interface

The SmartShell user interface consists of three views:

- **Camera view** — enables you to control cameras, create moves and presets, and configure axis limits and other axis settings. When you launch SmartShell, it opens in **Camera View** mode.
- **Matrix view** — consists of a grid of buttons that enable you to efficiently operate multiple cameras. For more information, see “**The Matrix View**” on [page 72](#).
- **Joystick Control Settings view** — enables you to configure how each camera responds to joystick movements. For more information, see “**Joystick Control Settings**” on [page 101](#).

[Figure 1](#) and the sections that follow describe the SmartShell user interface when it is in **Camera View** mode.

**Tip:** The numbers in [Figure 1](#) identify buttons and areas of the user interface that are described in the sections that follow. If you are reading this document on a computer, tap the numbered buttons or areas of the diagram to jump to the descriptions.

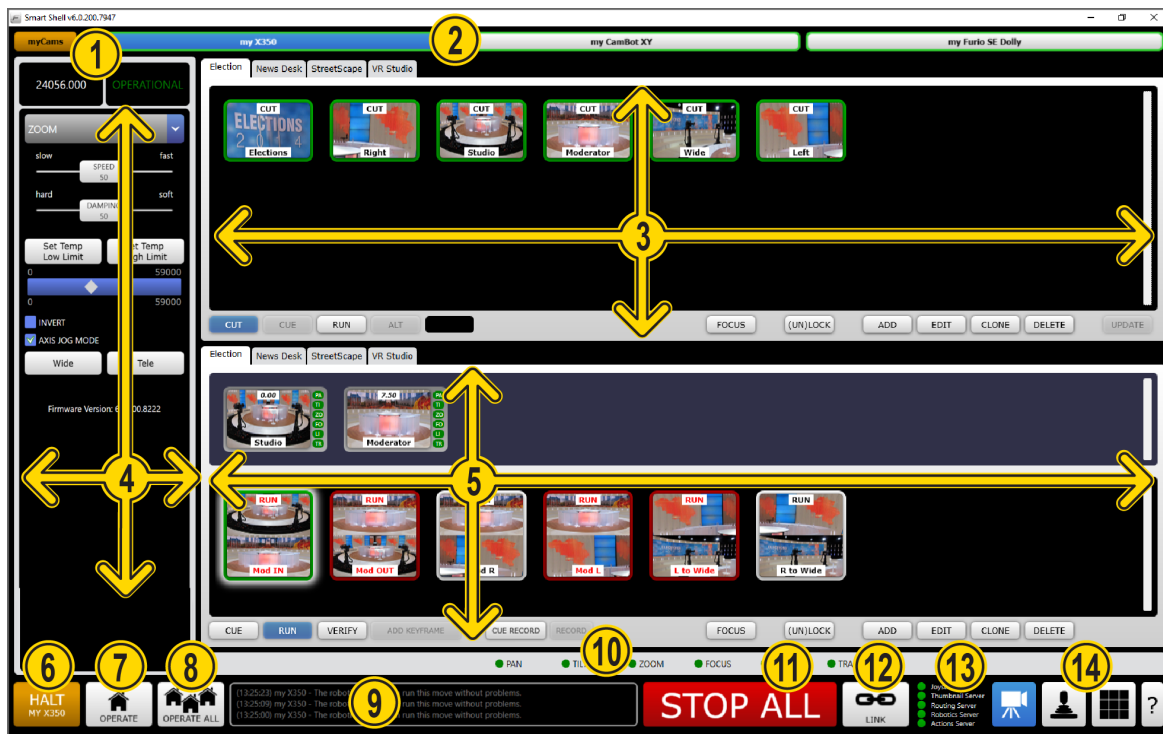


Figure 1 - SmartShell User Interface Elements

## 1 Camera Group Button

The **Camera Group** button opens a dialog box that enables you to define which robotic camera systems (cameras) are currently available for SmartShell control (the current camera group). The button text is the name of the current camera group.

The **Camera Selection** panel displays one button for each camera in the current camera group.

You can edit, load, and save camera groups.

For more information, see “**Working with Camera Groups**” on [page 22](#).

Tap [HERE](#) to view the user interface diagram.

## 2 Camera Selection Panel

The **Camera Selection** panel ([Figure 2](#)) features one camera button for each of the cameras that are currently available for SmartShell control. Camera buttons indicate the selection status and manual control status of each camera.

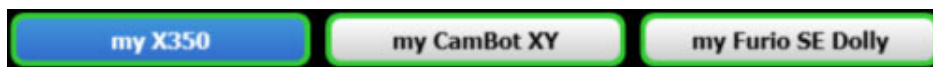


Figure 2 - Camera Selection Panel

To select a camera for control, tap its camera button.

When a camera is selected, you can view, edit, and recall its presets and moves. You can also use the **Joystick Control Settings** view to configure how the camera responds to joystick movements.

If your SmartShell computer has manual control of the selected camera, you can control it using the **Axis Control** panel and/or the joystick panel.

The **Camera Selection Panel** is always visible, whether SmartShell is in **Camera** view, **Joystick Control Settings** view, or **Matrix** view.

Each camera button consists of a center and a border, which are color-coded to indicate selection status and manual control status.

Camera buttons are color-coded as follows:

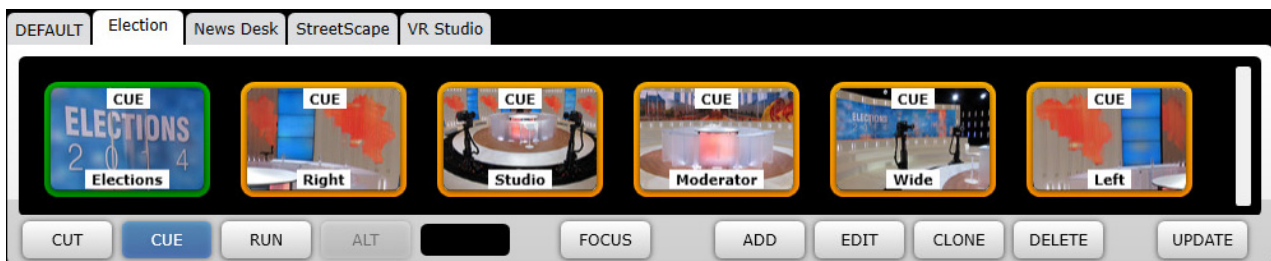
- The button center indicates whether the camera is currently selected in SmartShell:
  - › **blue center** — This camera is selected.  
Unless SmartShell is in **Matrix** view, it shows settings for the selected camera only. A maximum of one camera can be selected at a time.
  - › **gray center** — This camera is not selected.  
To select the camera, tap its camera button.
- The presence of a button border indicates whether the camera is connected. The border color indicates whether you have manual control of the camera:
  - › **no border (all gray button or all blue button)** - This camera is not currently connected.
  - › **green border** - The camera is connected, and you have manual control of it.  
To control the camera manually, use the **Axis Control** panel and/or the joystick panel.
  - › **red border** - The camera is connected, but you do not have manual control of it.  
A different SmartShell computer may or may not have manual control of it.
- If a camera button has a red dot, it is currently on-air.  
**Note:** This applies only if your system includes tally integration.
- Flashing red text on a camera button indicates an error message. For more information, see “**Notifications Window**” on [page 149](#).

For more information about the **Camera Selection** panel, see “**Selecting a Camera System to Control**” on [page 22](#).

Tap [HERE](#) to view the user interface diagram.

### 3 Presets Panel

In the **Presets** panel ([Figure 3](#)) you can create, modify, organize, and run presets.



**Figure 3 - Presets Panel**

A preset is a stored camera position that can be recalled by SmartShell. You can create presets and then edit them to specify additional optional settings.

Presets are arranged in categories. You can add and delete categories, and drag presets between categories. Each preset belongs to only one category but you can clone a preset and then drag it to a different category.

Each preset icon shows the duration and name of the preset. Optionally, a thumbnail photo taken from the destination position is also shown.

Presets can be dragged into moves to become move keyframes. For more information, see “**Moves**” on [page 46](#).

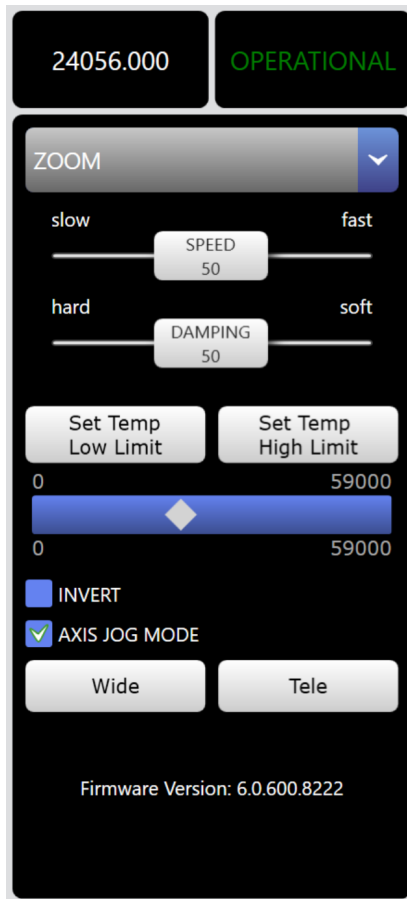
Presets can also be added to macros. A macro is a group of presets that can be run simultaneously from the **Matrix** view. For more information, see “**The Matrix View**” on [page 72](#).

For more information about presets, see “**Presets**” on [page 25](#).

Tap [HERE](#) to view the user interface diagram.

## 4 Axis Control Panel

The **Axis Control** panel ([Figure 4](#)) shows the status of the selected axis of the selected camera.



**Figure 4** - Axis Control Panel

In the **Axis Control** panel, you can:

- View the current axis position and operational status for each controllable axis.
- Configure how the selected camera responds to manual controls (joystick movements and axis movement buttons in the **Axis Configuration** panel)
- View and set temporary axis limits.
- For Furio dolly systems, view limits imposed by track reflectors and collision avoidance systems.
- Control the axis manually (axis jog mode)
- Align pedestal wheels to prepare for trucking (XY axis on CamBot XY pedestals only)
- Target the pedestal (XY axis on XY pedestals only)
- Override the Furio Collision Avoidance system if a dolly stops receiving position data from other dollies. Overriding the Collision Avoidance system enables you to continue using a Furio dolly if another dolly fails.

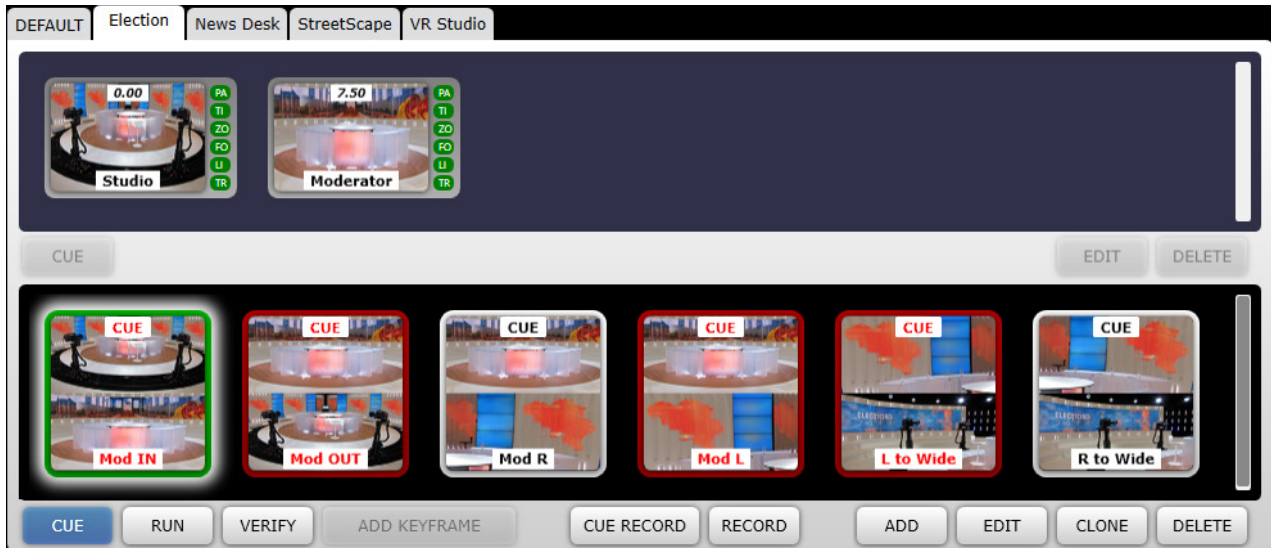
For more information, see “**Axis Configuration**” on [page 111](#).

Tap [HERE](#) to view the user interface diagram.

## 5 Moves Panel

The **Moves** panel ([Figure 5](#)) provides tools for creating, modifying, organizing, validating, and running moves.

Moves apply only to Furio robots and CamBot XY pedestals.



*Figure 5 - Moves Panel*

A move is a series of presets on a timeline. For each preset in the move, the time at which the preset position is reached (also called distance) is defined. The combination of a preset and distance in a move is called a keyframe. When a move is recalled, the camera moves from the first preset position, through each of the others, to the last. For each keyframe, the camera reaches the associated preset position at the time specified by the keyframe's distance.

Only certain robotic camera systems can perform moves. Furio robots and CamBot XY pedestals can perform both moves and presets. Standalone CamBot Pan & Tilt robotic heads can perform only presets. When SmartShell controls a robot that cannot perform moves, the **Moves** panel is not shown, and the **Presets** panel is enlarged.

The **Moves** panel consists of two main areas: the **keyframes** area (top) and the **moves** area (bottom).

In the **keyframes** area, you can add keyframes to the selected move by dragging them from the presets panel. You can edit the properties of the keyframes to change how the camera behaves when the move is recalled. You can edit a keyframe's position (distance) on the timeline, enable or disable individual axes, modify the acceleration and deceleration rates for most axes, and adjust the curve tension for the XY axis (CamBot XY pedestals only). You can also clone or delete keyframes.

In the **moves** area you can select, add, edit, clone, and delete moves. You can also verify the validity of moves, cue them, and run them. When you select a move, the keyframes that comprise the move appear in the keyframes area.

When triggered, a move can be run once or, if it has identical start and finish keyframe positions, it can be run in a continuous loop.

In the **Moves** panel, moves are arranged in categories. You can add and delete categories, and drag moves between categories. Each move belongs to only one category but you can clone a move and then drag it to a different category.

For more information about moves, see "**Moves**" on [page 46](#).

Tap [HERE](#) to view the user interface diagram.

## 6 HALT Button

The **HALT** button ([Figure 6](#)) enables you to stop the selected robot without releasing joystick control. After a robot is halted you can still control it as usual, either manually or through presets, macros, and moves.

**Note:** Whenever a robot is halted an error message (WARNING) is generated.

The **HALT** button shows the name of the selected camera, which stops when you tap the button.



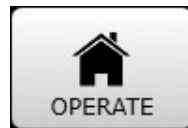
*Figure 6 - HALT Button*

**Tip:** There is also a **STOP ALL** button, which immediately stops the motion of all connected cameras. For more information, see "**Axis Activation Panel**" on [page 16](#).

Tap [HERE](#) to view the user interface diagram.

## 7 OPERATE Button

The **OPERATE** button ([Figure 7](#)) enables you to take control of the selected camera.



*Figure 7 - OPERATE Button*

Tap [HERE](#) to view the user interface diagram.

## 8 OPERATE ALL Button

The **OPERATE ALL** button ([Figure 8](#)) enables you to take control of all connected cameras.



*Figure 8 - OPERATE ALL Button*

Tap [HERE](#) to view the user interface diagram.

## 9 Notifications Panel

The **Notifications** panel lists error messages and other system notifications. To view all notifications in a larger window, tap the **Notifications** panel. For more information, see "**Notifications Window**" on [page 149](#).

Tap [HERE](#) to view the user interface diagram.

## 10 STOP ALL Button

The **STOP ALL** button ([Figure 9](#)) immediately halts the motion of all connected cameras.

**Note:** **STOP ALL** releases joystick control of all robots. To regain joystick control of all cameras, tap the **OPERATE ALL** button.



*Figure 9 - STOP ALL Button*

**Tip:** There is also a **HALT <robot name>** button, which halts the motion of the selected camera only without releasing joystick control. For more information, see “**HALT Button**” on [page 15](#).

Tap [HERE](#) to view the user interface diagram.

## 11 Axis Activation Panel

The **Axis Activation** panel ([Figure 10](#)) enables you to activate or deactivate individual axes for joystick operation, or for recording axis movements for a move. It does not affect presets and moves.



*Figure 10 - Axis Activation Panel for a Furio Dolly*

Limiting which axes the joystick panel can move may help prevent unintentional movement of the camera. For more information, see “**The Joystick Panel**” on [page 90](#).

To activate or deactivate an axis, tap the name of the axis to change its dot to green (activated) or red (deactivated).

Tap [HERE](#) to view the user interface diagram.

## 12 Vision[Ai]ry Button

The Vision[Ai]ry button ([Figure 11](#)) activates tracking modes in Vision[Ai]ry Ft for the camera that is currently selected in Vision[Ai]ry Ft.

**Tip:** If the Vision[Ai]ry button is enabled for your robotic system, by default it appears in one of two states (**AI ON** or **AI ONESHOT**). To access the other state, press **SHIFT** before you tap the button.



*Figure 11 - The Two States of the Vision[Ai]ry Button — AI ON (left) and AI ONESHOT (right)*

**You can do one of the following:**

- To turn on **Active Tracking** in Vision[Ai]ry Ft, tap **AI ON**.

**Tip:** If the button text says **AI ONESHOT**, press **SHIFT** and then tap **AI ON**.

One of the following happens:

- › If a subject is already selected, Vision[Ai]ry Ft controls the camera to track the selected subject.
- › If **Face Selection** is set to **Auto**, Vision[Ai]ry Ft selects a subject and controls the camera to track that subject.
- › If no subject is selected and **Face Selection** is set to **Manual**, Vision[Ai]ry Ft turns on **Active Tracking** mode, but does not track a subject.

- To activate **One-Shot** mode in Vision[Ai]ry Ft, press **SHIFT** and tap **AI ONESHOT**.

**Tip:** If the button text says **AI ON**, press **SHIFT** and then tap **AI ONESHOT**.

One of the following happens:

- › If a subject is already selected, Vision[Ai]ry Ft controls the camera to frame the selected subject, and then turns **Active Tracking** mode off. Vision[Ai]ry Ft does not continue to track the subject.
- › If **Face Selection** is set to **Auto**, Vision[Ai]ry Ft selects a subject, controls the camera to frame that subject, and then turns **Active Tracking** mode off. Vision[Ai]ry Ft does not continue to track the subject.
- › If no subject is currently selected and **Face Selection** is set to **Manual**, Vision[Ai]ry Ft turns off **Active Tracking** mode, but does move the camera.

If the Vision[Ai]ry button is not shown, this feature has not been enabled for your robotic control system.

If the Vision[Ai]ry button appears unavailable ([Figure 12](#)), this feature is not enabled for the selected camera.



**Figure 12** - Vision[Ai]ry Button, shown as Unavailable

For more information about Vision[Ai]ry Ft, see the **Setup and User Guide for Vision[Ai]ry Ft (5100DR-090-xx)**.

Tap [HERE](#) to view the user interface diagram.

## 13 LINK Button

The **LINK** button ([Figure 13](#)) controls whether selecting a camera on one interface selects it on all others within the same workstation.

For example, if camera selection is linked, selecting a camera in a DashBoard application panel such as the PTZ Camera Control plugin also selects it in SmartShell and on the joystick panel.

The **LINK** button has two states:

- When camera selection between interfaces is linked, the chain icon on the **LINK** button appears connected, as shown on the left side of [Figure 13](#).
- When camera selection between interfaces is not linked, the chain icon on the **LINK** button appears broken, as shown on the right side of [Figure 13](#).



**Figure 13** - LINK Button (linked (left), and not linked (right))

Tap [HERE](#) to view the user interface diagram.

14

## Connection Status Indicators

The **Connection Status Indicators** (Figure 14) indicate whether SmartShell has a working connection to the listed services. Green indicates a working connection. Red indicates no connection.

Figure 14 shows all possible indicators. Each indicator appears only if SmartShell is configured to use the associated service.

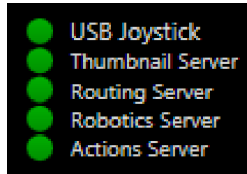


Figure 14 - Connection Status Indicators for the Legacy Joystick Panel

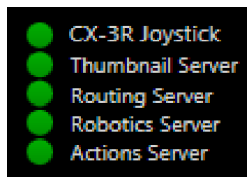


Figure 15 - Connection Status Indicators for the CX-3R Joystick Panel

Connection health is checked every 15 seconds by default. The default reconnect interval is 30 seconds. If these indicators remain red for more than one minute, contact your system administrator.

The connection status indicators are as follows:

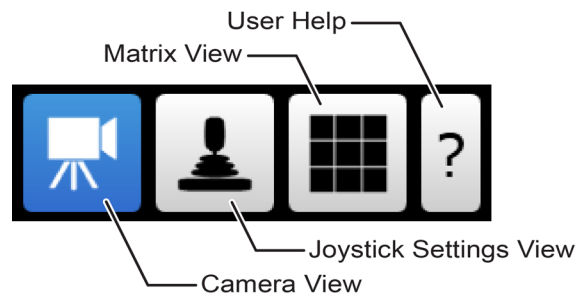
- **Joystick** — Indicates the connection status to a joystick panel. **USB Joystick** for a connection to a **Legacy Joystick Panel** over USB, and **CX-3R Joystick** for a connection to a **CX-3R Joystick Panel** through the CX Panel Adapter service. In addition to appearing green (connected) or red (connected, but with issues), this indicator can also appear gray to indicate that SmartShell has not been able to connect to the USB joystick or CX Panel Adapter Service.
- **Thumbnail Server** — Indicates that SmartShell is able to perform thumbnail management operations (add, update, delete, and clone).
- **Routing Server** — Indicates that SmartShell is able to send video switch requests to the Routing Server (to switch the video of the optional operator monitor).
- **Robotics Server** — Indicates that SmartShell is able to communicate device selection information with the system.
- **Actions Server** — Indicates that SmartShell is connected to the Ancillary Actions Server running on the server. The AAS is required for camera settings (paint) recall. It starts and stops with the Robotics Server.

Tap [HERE](#) to view the user interface diagram.

15

## View Buttons and Help Button

The lower right corner of the SmartShell interface (Figure 16) includes four view buttons.



**Figure 16** - Buttons for Selecting Interface Views, and for Launching User Help

The view buttons operate as follows:

- **Camera View** button — Switches the interface to Camera View mode. In [Figure 16](#), the Camera View button is selected (blue).
- **Joystick Settings** button — Switches the interface to show settings for configuring how each camera responds to joystick movements. For more information, see “**Joystick Control Settings**” on [page 101](#).
- **Matrix view** button — Switches the interface to show the Matrix, which is a grid of customizable buttons that enable you to efficiently operate multiple cameras.  
Each button represents a predefined action such as cueing/running a move, cutting to a preset, and cueing/running a preset. You can also create and run macros, which are groups of presets that can be run simultaneously. In the Matrix, you can create, store, and perform hundreds of actions.  
how.  
For more information, see “**The Matrix View**” on [page 72](#).
- **User Help** button — Launches the User Help system, which contains information about using SmartShell.

Tap [HERE](#) to view the user interface diagram.

## Starting the Ross Robotics System

This section describes how to start the Ross Robotics system, and how to take control of camera systems (cameras).

### Start the Ross Robotics System

To start the system, you turn on all the components and then start the SmartShell control application.

#### To start the Ross Robotics System:

1. Ensure that the following components are turned on:
  - All robotic cameras
  - Robotics Server computer (if equipped)
  - Ethernet network switch
  - Video router (if equipped)
  - SmartShell computer
  - Operator’s video monitor (if equipped)
2. Log on to the SmartShell computer.
3. Double-tap the SmartShell icon on the computer desktop.  
SmartShell starts.

### Take Control of Cameras

You can take control of individual cameras, or all cameras.

**Note:** Depending on your system's configuration, taking joystick control of a robot that another client already has control of may prompt a dialog box to confirm or cancel the control takeover. Refer to "**Joystick Control Confirmation**" on [page 122](#).

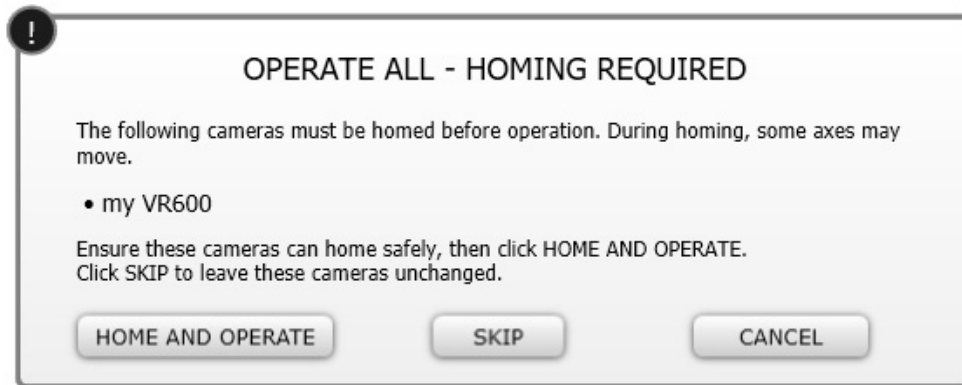
**To take control of all cameras:**

1. At the bottom of the SmartShell application, tap the **OPERATE ALL** button.



**Figure 17** - OPERATE ALL Button

If any cameras require homing the following dialog box appears, listing those cameras.



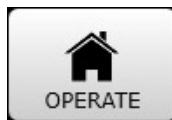
**Figure 18** - OPERATE ALL - HOMING REQUIRED Dialog box

**Note:** When a camera performs homing operations, its pan, tilt, and lift axes may move.

2. If one or more cameras require homing, do the following:
  - Check whether each listed camera has sufficient space for the pan, tilt, and lift axes to move without risk of hitting another camera or other objects, and then:
    - › If you are certain the listed cameras can all home safely, tap **HOME AND OPERATE**. SmartShell takes control of all cameras, and homes those that require homing. After homing is complete, all cameras can be controlled.
    - › If there is a chance that one or more of the listed cameras cannot home safely, tap **SKIP**. SmartShell takes control of cameras that do not require homing.
3. If one or more cameras are XY pedestals, target them. Targeting a pedestal enables it to determine where it is on the studio floor, and what direction it is facing. For more information, see "**Targeting XY Pedestals**" on [page 124](#).

**To take control of an individual camera:**

1. In the **Camera Selection** panel, tap the name of the camera you want to control.
2. Tap the **OPERATE** button.



**Figure 19** - OPERATE Button

Information about the selected camera appears. You can now control it.

3. If the camera is an XY pedestal, target it.

Targeting a pedestal enables it to determine where it is on the studio floor, and what direction it is facing. For more information, see **“Targeting XY Pedestals”** on [page 124](#).

**For More Information About...**

- the SmartShell user interface, see **“SmartShell User Interface”** on [page 10](#)
- selecting a camera to control, see **“Selecting a Camera System to Control”** on [page 22](#)
- programming presets and moves, see **“Presets”** on [page 25](#), and **“Moves”** on [page 46](#)

# Selecting a Camera System to Control

This section describes how to select a camera system (camera) to control.

**Note:** SmartShell shows one group of cameras at a time. If the button for the camera you want to control is not shown in the **Camera Selection** panel, it is not in the current camera group. To access cameras that are not shown, you can load a different camera group or edit the current camera group. For more information, see “**Working with Camera Groups**” on [page 22](#).

## To select a camera:

1. In the **Camera Selection** panel, tap the camera button for the camera you want to control.  
If the **Operate** button appears in the middle of the screen, tap it.  
The camera is selected. The center of the camera button turns blue. You can now view, edit, and recall presets and moves for this camera.  
If the border of the camera button is green, your SmartShell computer has manual control of the camera. You can control the camera using the **Axis Control** panel and/or a joystick panel.
2. If you want to control the selected camera manually and the border of camera button border is not green, tap the **Operate** button at the bottom of the **Axis Control** panel.  
SmartShell takes manual control of the camera. You can control the camera using the **Axis Control** panel and/or the joystick panel.  
**Tip:** When you take control of a camera, other users lose manual control.

## For More Information About...

- the SmartShell user interface, see “**SmartShell User Interface**” on [page 10](#)
- programming presets and moves, see “**Presets**” on [page 25](#), and “**Moves**” on [page 46](#)

# Working with Camera Groups

A camera group is a list of cameras that defines which cameras are available for SmartShell control. The **Camera Selection** panel displays one button for each camera in the current camera group. Camera groups can be saved and later loaded into SmartShell.

This section describes how to use the **EDIT CAMERA GROUP** dialog box to edit the current camera group, load a camera group file, and create a new camera group file.

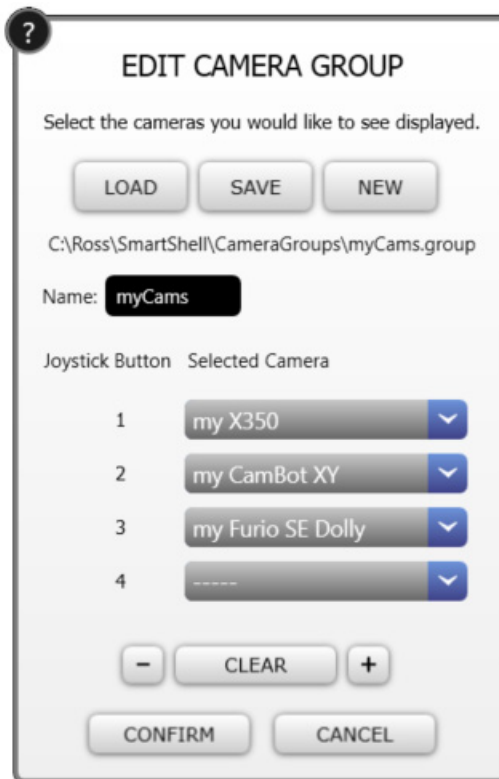
## To open the Edit Camera Group dialog box:

1. In the top left corner of SmartShell, tap the **Camera Group** button.



*Figure 20 - Camera Group Button for a Camera Group Named myCams*

**Tip:** The **Camera Group** button displays the name of the current camera group. The **EDIT CAMERA GROUP** dialog box appears ([Figure 21](#)).



**Figure 21** - EDIT CAMERA GROUP Dialog Box

The **EDIT CAMERA GROUP** dialog box shows includes a list of cameras. The order of the list defines the order in which the camera buttons appear in the **Camera Selection** panel and on the Legacy Joystick Panel and CX-3R Joystick Panel.

**To edit the current camera group:**

1. Open the **EDIT CAMERA GROUP** dialog box.
2. If you want to delete the list and start with an empty list, tap **CLEAR**.  
All cameras are removed from the list, and the group name is set to **EMPTY**.
3. If you want to change the name of the camera group, tap the **Name** box and then type the new name.
4. Starting with the first row you want to change, tap the row and then select the camera you want to assign to that row.  
For example, if you are editing the third row of the list, select the camera you want to assign to the third camera button and to the third joystick button.  
**Tip:** If you want to add a row to the bottom of the list, tap the plus sign ( + ).
5. After you have assigned all the cameras you want in the group, delete any extra rows by tapping the minus sign ( - ) repeatedly until all extra rows are gone.
6. If you want to save the changes, tap **SAVE**, and then do one of the following:
  - To update the current camera group file, navigate to the folder where the file is stored, select the file, and then tap **Save**. When prompted, overwrite the original file.
  - To create a new camera group file, navigate to the folder where you want to store the file, specify a name for the file, and then tap **Save**.
7. Tap **CONFIRM** to apply the changes and close the **EDIT CAMERA GROUP** dialog box.  
The changes are applied.  
**Tip:** If you did not save the changes, an asterisk appears on the **Camera Group** button.

**To load and apply a camera group file:**

1. Open the **EDIT CAMERA GROUP** dialog box.
2. Tap **Load**.  
The **Open** dialog box appears.
3. Navigate to the camera group (*.group*) file you want to open, and then click **Open**.
4. Tap **CONFIRM**.  
The loaded camera group file is applied.

**To load a camera group file for editing, without applying it:**

1. Open the **EDIT CAMERA GROUP** dialog box.
2. Tap **Load**.  
The **Open** dialog box appears.
3. Navigate to the camera group (*.group*) file you want to open, and then click **Open**.
4. Edit the group **Name** and/or rows of the list.
5. Tap **SAVE**, and then save the file.
6. Tap **CANCEL** to close the **EDIT CAMERA GROUP** dialog box.

**To create a new camera group file:**

1. Open the **EDIT CAMERA GROUP** dialog box.
2. Tap **NEW**.  
The camera list is populated with all the cameras that are registered in SmartShell. The name of the camera group is set to **ALL**.
3. Tap the **Name** box and then type a name for the new camera group.
4. Edit the camera list as required:
  - a. Starting with the first row you want to change, tap the row and then select the camera you want to assign to that row.  
  
For example, if you are editing the third row of the list, select the camera you want to assign to the third camera button and to the third joystick button.
  - b. After you have assigned all the cameras you want in the group, delete any extra rows by tapping the minus sign ( - ) repeatedly until all extra rows are gone.
5. Tap **SAVE**, navigate to the folder where you want to store the new file, specify a name for the file, and then tap **Save**.
6. Do one of the following:
  - If you want to apply the changes, Tap **CONFIRM**.  
The changes are applied, and the **EDIT CAMERA GROUP** dialog box closes.
  - If you want to close the **EDIT CAMERA GROUP** dialog box without applying the changes, tap **CANCEL**.  
The **EDIT CAMERA GROUP** dialog box closes.

**Tip:** If you did not save the changes, an asterisk appears on the **Camera Group** button.

# Presets

A preset is a stored camera position that can be recalled by SmartShell. When an operator recalls a preset, the camera moves to the position defined by the preset.

The following sections contain information about working with presets:

- “**Preset Panel Icons**” on [page 25](#)
- “**Preset Categories**” on [page 26](#)
- “**Add a Preset**” on [page 29](#)
- “**Edit a Preset**” on [page 31](#)
- “**Clone a Preset**” on [page 37](#)
- “**Update a Preset Position**” on [page 37](#)
- “**Delete a Preset**” on [page 38](#)
- “**Recall a Preset**” on [page 38](#)
- “**Alternative Cue/Cut Speed**” on [page 42](#)
- “**About CamBot XY Pedestals: Base Rotation, Panning, and Presets**” on [page 43](#)

**Tip:** For Furio robots and CamBot XY pedestals running Furio firmware v5.0 (or higher), presets also form the basis of moves. A move consists of a sequence of presets on a timeline. For more information, see “**Moves**” on [page 46](#).

## Preset Panel Icons

In the **Presets** panel, each preset icon is color-coded to indicate the status of the preset:

- **white glow surrounding the icon** — This is the selected preset.
- **orange border** — The preset is not cued. Cueing presets applies to CamBot XY pedestals only.  
To cue the preset, tap the **CUE** button to make the word **CUE** appear in the preset icon, then tap the preset icon.

When cueing is complete, the border of the preset icon turns green.

When operating a CamBot XY pedestal, presets for on-air shots should be cued before you run them. Cueing rotates the pedestal base so that the wheels face the destination. If you run a preset without cueing it, the pedestal base rotates in place before the camera moves towards the destination, which may be undesirable for on-air shots. Sometimes the base rotates at the start of a preset even when no XY (floor) movement is required, to ensure that after the preset you can manually pan at least 20° in each direction. This panning buffer may be less than 20° in some cases.

**Note:** Cueing does not apply to Vinten XY pedestals.

**IMPORTANT:** Unlike scalar axes, all pedestal movements result in the current preset being uncued.

- **green border** — The preset is cued, and is ready to be run. Cueing presets applies to CamBot XY pedestals only.
- **dark blue border** — The preset is the most recently recalled preset and the camera is still in the destination position.
- **light blue border** — The preset is the most recently recalled preset, but the camera’s position has changed by joystick control since the preset was recalled.

# Preset Categories

In the **Presets** panel, presets are arranged in category tabs (Figure 22). You can sort presets, drag presets between categories, add new categories, clone categories, rename categories, and delete categories.



*Figure 22 - Category Tabs in the Presets Panel*

You can use categories to group presets and moves related to a particular purpose or show. There is always at least one category. The **DEFAULT** category is always present.

## Sort Presets

You can sort presets and moves alphabetically, or by date. When you sort, all presets and moves in all categories are sorted for all cameras controlled by SmartShell.

### To sort presets and moves:

1. Touch and hold an empty area of the **Presets** panel until a circle appears, and then release it.  
**Tip:** If you are using a mouse, right-click an empty area of the **Presets** panel.  
The sort menu appears.
2. In the sort menu, tap one of the following:
  - **Name (A->Z)**, to sort alphabetically.
  - **Name (Z->A)**, to sort reverse-alphabetically.
  - **Date (Old->New)**, to sort by order of creation, from oldest to newest.
  - **Date (New->Old)**, to sort by order of creation, from newest to oldest.

## Drag a Preset from One Category to Another

### To drag a preset from one category to another:

- In the **Presets** panel, drag the preset icon to the destination category tab.

## Add a Category

### To add a category:

1. In the **Presets** panel, touch and hold a category tab until a circle appears, and then release it.  
**Tip:** If you are using a mouse, right-click any category tab.
2. On the category menu, tap **Add New Category**.  
The **ADD CATEGORY** dialog box appears.
3. Type a name for the category, and then tap **OK**.  
**Tip:** Depending on how your system is configured, a unique category name may be required.

## Rename a Category

You can rename any preset category except the **DEFAULT** category.

**To rename a preset category:**

1. In the **Presets** panel, press and hold the category tab until a circle appears, and then release it.  
**Tip:** If you are using a mouse, right-click the category tab.
2. On the category menu, tap **Rename Category**.  
The **EDIT CATEGORY** dialog box appears.
3. Type a new name for the category, and then tap **OK**.  
**Tip:** Depending on how your system is configured, a unique category name may be required.

## Clone a Category

You can clone a preset category to make a copy of it, and then modify it as needed.

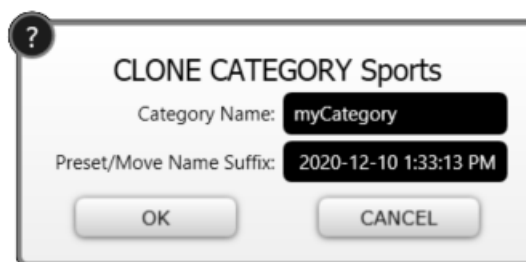
Preset categories and move categories are linked. When you clone a category from either the **Presets** panel or the **Moves** panel, the identically-named category in the other panel is also cloned.

**Note:** If you clone a category that contains moves that reference presets from other categories, the referenced presets are cloned. For example, if a move in Category A uses a preset from Category B, and you clone Category A, the **Presets** panel in the new category contains a clone of the Category B preset. There is no link between the new preset and the original.

**Note:** If you clone a category that has moves or presets with external IDs, edit the cloned moves or presets to assign external IDs as required. Certain types of automation control systems require that moves and presets have external IDs. The ability to assign external IDs is available only if your Ross Robotics system is configured to interact with a control automation system that requires them.

**To clone a category:**

1. In the **Presets** panel, press and hold the category tab until a circle appears, and then release it.  
**Tip:** If you are using a mouse, right-click the category tab.
2. On the category menu, tap **Clone Category**.  
The **CLONE CATEGORY** dialog box appears ([Figure 23](#)).



**Figure 23** - CLONE CATEGORY Dialog Box

3. In the **Category Name** box, type a name for the new category.  
**Tip:** Depending on how your system is configured, a unique category name may be required.
4. In the **Preset/Move Name Suffix** box, type characters that you want added to the end of the preset names and move names in the new category, to make the names unique.  
**Tip:** Depending on how your system is configured, a suffix may not be required.
5. Tap **OK**.  
The category is cloned, creating a new category.

## Delete a Category

Move categories and preset categories are linked. When you delete a category from either the **Presets** panel or the **Moves** panel, the identically-named category in the other panel is also deleted. Deleting a category also deletes all presets and moves within it.

**Note:** You cannot delete a category that contains locked moves or presets. Icons for locked items have a lock symbol. For more information about locked items, see “[Locking Presets and Moves](#)” on [page 74](#).

**Note:** You cannot delete the **DEFAULT** category. It is always present.

### To delete a category and all presets and moves within it:

1. In the **Presets** panel, press and hold the category tab until a circle appears, and then release it.  
**Tip:** If you are using a mouse, right-click the category tab.
2. On the category menu, tap **Delete Category**.  
The **CONFIRM DELETE** dialog box appears.
3. Depending on the message in the **CONFIRM DELETE** dialog box, do one of the following:
  - **Are you sure you want to delete category 'name'?** — The category is empty. To delete it, tap **YES**. Otherwise, tap **NO**.
  - **Category 'name' cannot be deleted because it contains locked moves or presets** — You cannot delete locked items. If you want to delete only the unlocked moves and presets in the category, delete them one by one. Icons for locked items have lock symbols.
  - **Category 'name' is not empty!** — If you want to delete the category and all the moves and presets it contains, tap **YES**. Otherwise, tap **NO**.

**Note:** If you delete a preset that is used by a Matrix button, the Matrix button is shown as “DELETED” ([Figure 29](#)). There is no advance warning that the preset is used by a Matrix button. We recommend you keep your presets, categories, and matrices well organized to help prevent problems.



*Figure 24 - Matrix Button After its Preset has been Deleted*

4. If the **CANNOT DELETE CATEGORY** message appears, the category contains the name of a preset that cannot be deleted.  
Move the preset into a category that is not being deleted, and then try again to delete the unwanted category.

## The Temporary Category

Depending on how your system is configured, when SmartShell starts it may create a special temporary category as a location where you can create and store new presets and moves without affecting existing categories.

The temporary category works the same as any other category, except that when you close SmartShell, you are prompted to delete or retain it.

The temporary category is especially useful if your organization maintains a standard set of Matrix files and categories with locked presets.

For example, if you load a Matrix file and you want to modify a locked preset for immediate temporary use, you can use the **ADD & ASSIGN** feature to replace the preset button in the Matrix, and store the new preset in the temporary category. In the **ADD & ASSIGN** dialog box, the temporary category is selected by

default. When you close SmartShell, opt to delete the temporary category and close without saving changes to the Matrix file (**DELETE AND CLOSE**). Your changes are not saved, and the system is ready for the next user.

**Note:** The name of the temporary category is configured by your administrator. If you rename it, it is not deleted when SmartShell closes.

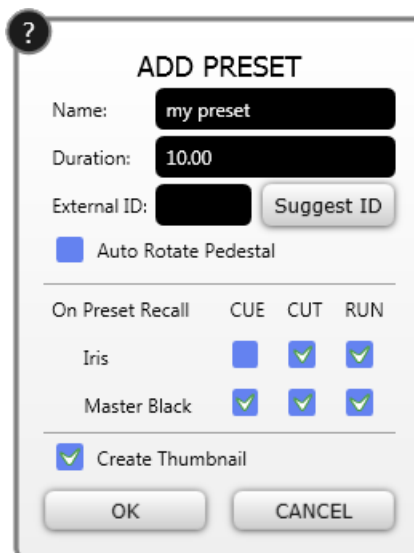
## Add a Preset

When you add a preset, it appears in the **Presets** panel in the current preset category.

**Tip:** You can also create presets from the Matrix view. For more information, see “**Create a New Preset Action on a Matrix Button**” on [page 79](#).

**To add a preset:**

1. In the **Camera Selection** panel, tap the camera you want to use in the new preset.
2. If the **Operate** button appears, or if the camera selection button has a red outline, tap the **Operate** button to take control of the camera.  
**Tip:** The camera selection button must be blue with a green outline before you can create a preset.
3. Manually position the camera exactly where you want it to be for the preset, in all controllable axes.  
**Tip:** You can manually position the camera in SmartShell, or using the joystick panel.
4. In the **Presets** panel, tap the category tab upon which you want to create a preset.
5. Tap **ADD**.  
The **ADD PRESET** dialog box appears ([Figure 25](#)).



**Figure 25** - ADD PRESET Dialog Box (for CamBot XY Pedestal)

6. In the **Name** box, type a name for the new preset.  
**Note:** Depending on how the system is configured, it may not allow the name of the new preset to be the same as an existing preset and/or move.
7. In the **Duration** box, type the default duration of the preset recall, in seconds.  
**Tip:** Alternatively, you can use the joystick panel to adjust the duration instead of typing.
  - On the Legacy Joystick Panel, use the **TIME** knob to set the duration.
  - Depending on the system's configuration, you may need to press and hold the **ALT** button while you turn the **TIME** knob.

- On the CX-3R Joystick Panel, use the **Duration** knob to set the duration.
8. If the **External ID** box is visible and you want to make the preset available to the automation control system, do one of the following:
    - To assign a particular ID, in the **External ID** box, type the ID number.  
The number must be unique within the category, or unique overall, depending on how your system is configured. If the number is not sufficiently unique, an error message appears when you submit the request.
    - To request that SmartShell assign an ID, tap the **Suggest ID** button.  
An ID number appears in the **External ID** box.

**Tip:** External IDs enable the automation control system to run moves and presets. The **External ID** box is visible only if your system is configured to interact with an automation control system that requires external IDs.
  9. If the camera is a CamBot XY pedestal, and you want the system to recall the current rotational position of the base as part of the preset, select the **Auto Rotate Pedestal** check box.  
This option rotates the pedestal base at the end of the preset recall, aligning the wheels to a known position.  
**Tip:** Use the **Auto Rotate Pedestal** option when the pedestal's next destination is known, such as for a pair of presets designed for side-to-side trucking motion. The **Auto Rotate Pedestal** option is also useful when creating a preset for the CamBot target position, because the base must be properly aligned with the target. Avoid using this option for all your presets, as it may result in unnecessary base rotation. Instead, after a preset runs, cue the next preset to rotate the base.  
For more information about pedestal base rotation and presets, see "**About CamBot XY Pedestals: Base Rotation, Panning, and Presets**" on [page 43](#).  
**Note:** This feature does not apply to Vinten XY pedestals.
  10. In the **On Preset Recall** area, specify whether you want each of the listed camera settings to be recalled at the start of **CUE**, **CUT**, and **RUN** operations.  
**Note:** The **On Preset Recall** area is present only if the camera is configured for recall of paint settings.  
Whenever you add a preset, all listed camera settings are saved. The **On Preset Recall** settings enable you to specify when the saved camera settings are applied. Because the camera settings are always saved, you can edit the preset to adjust the **On Preset Recall** settings anytime.
  11. If you want the preset icon to show a thumbnail view from the camera's position, select the **Create Thumbnail** check box.  
**Note:** This option is available only if your Ross Robotics system is configured to include thumbnails.
  12. Tap **OK** to create the preset.  
If an error message appears, informing you that the **External ID** is not unique, specify a different ID and then tap **OK**.  
The new preset appears in the **Presets** panel.  
**Tip:** If the preset is for a Furio camera or a CamBot XY pedestal running Furio firmware v5.0 (or higher), you can edit the preset to specify acceleration and deceleration for each axis.

**For More Information About...**

- manually positioning the camera in SmartShell, see "**Manual Operation in SmartShell**" on [page 139](#)
- manually positioning the camera using the joystick panel, see "**The Joystick Panel**" on [page 90](#)
- editing presets, see "**Edit a Preset**" on [page 31](#)
- creating moves, see "**Moves**" on [page 46](#)

# Edit a Preset

When you first create a preset, it includes the position of the camera and a few other basic properties. You can edit a preset to modify these properties and to adjust additional settings that are not available when you first created the preset.

This section describes how to edit presets for various types of robots. The available settings for presets depend on the type of robot you are operating. For example, Furio robots have different settings than CamBot robots, and XY pedestals have different settings than other types of robots.

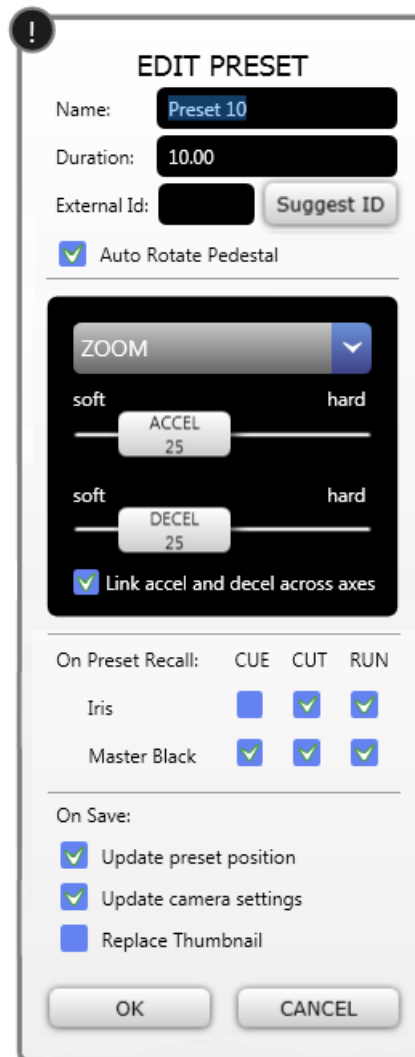
Editing a preset changes it permanently in the **Presets** panel, on Matrix buttons (including macros), and in moves.

**Tip:** If your system includes thumbnail images, you can quickly update them by editing the associated presets.

**Tip:** If you want to quickly update only the physical position of the camera in the preset (pan, tilt, lift, XY, and track axes), use the **UPDATE** button. For more information, see “**Update a Preset Position**” on [page 37](#).

## To edit a preset for a Furio robot, or a CamBot XY pedestal running Furio firmware v5.0 (or higher)

1. In the **Presets** panel, enable edit mode by tapping the **EDIT** button.  
Edit mode is enabled when the **EDIT** button is highlighted blue.
2. Tap the preset you want to edit.  
The **EDIT PRESET** dialog box appears ([Figure 26](#)).



**Figure 26** - EDIT PRESET Dialog Box for a CamBot XY Pedestal Running Furio Firmware

**Note:** If the title of the dialog box is **EDIT PRESET (LOCKED)**, the preset cannot be edited. You can clone the preset and then edit the cloned copy.

3. If you want to rename the preset, type the new name in the **Name** box.

**Note:** When you rename a preset in the **Presets** panel, it is also renamed in move keyframes and in the Matrix.

**Note:** Depending on how the system is configured, it may not allow the new name to be the same as the name of an existing preset and/or move.

4. If you want to specify or change the amount of time it takes for the preset to run, type a duration value, in seconds, in the **Duration** box.

**Tip:** Alternatively, you can use the joystick panel to adjust the duration instead of typing.

- On the Legacy Joystick Panel, use the **TIME** knob to set the duration. Depending on how the system is configured, you may need to press and hold the ALT button while you turn the **TIME** knob.
- On the CX-3R Joystick Panel use the **Duration** knob to set the duration.

5. If the **External ID** box is visible and you want to change the external ID, do one of the following:

- To assign a particular ID, in the **External ID** box, type the ID number.

The number must be unique within the category, or unique overall, depending on how your system is configured. If the number is not sufficiently unique, an error message appears when you submit the request.

- To request that SmartShell assign an ID, tap the **Suggest ID** button.  
An ID number appears in the **External ID** box.
- To delete the external ID without specifying a new one, delete the contents of the box.  
Deleting the ID makes the preset unavailable to the automation control system.

**Tip:** External IDs enable the automation control system to run moves and presets. The **External ID** box is visible only if your system is configured to interact with an automation control system that requires external IDs.

6. If the robot is a CamBot XY pedestal and you want the system to recall the current rotational position of the base as part of the preset, select the **Auto Rotate Pedestal** check box.

This option rotates the pedestal base at the end of the preset recall, aligning the wheels to a known position.

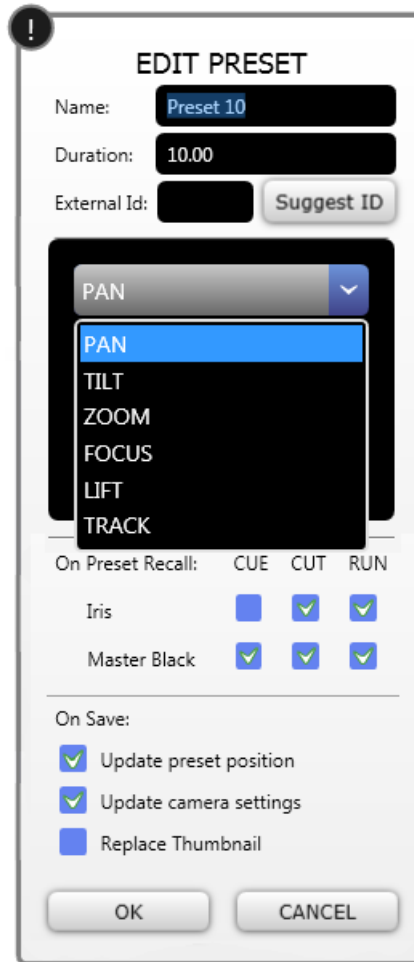
**Tip:** Use the **Auto Rotate Pedestal** option when the pedestal's next destination is known, such as for a pair of presets designed for side-to-side trucking motion. The **Auto Rotate Pedestal** option is also useful when creating a preset for the CamBot target position, because the base must be properly aligned with the target. Avoid using this option for all your presets, as it may result in unnecessary base rotation. Instead, after a preset runs, cue the next preset to rotate the base.

**Note:** The **Auto Rotate Pedestal** check box is visible only if the camera is a CamBot XY pedestal. This feature does not apply to Vinten XY pedestals.

For more information about pedestal base rotation and presets, see “**About CamBot XY Pedestals: Base Rotation, Panning, and Presets**” on [page 43](#).

7. If you want to change the acceleration and/or deceleration rate of an axis, do the following:

- a. In the axis list, tap the name of an axis for which you want to change acceleration rate and/or deceleration rate (Figure 27).



**Figure 27** - EDIT PRESET Dialog Box for Furio, with Axis List Expanded

- b. To set the acceleration rate, drag the **ACCEL** slider.  
 Drag the **ACCEL** slider towards soft for slower acceleration, or towards hard for faster acceleration.
- c. To set the deceleration rate, drag the **DECCEL** slider.  
 Drag the **DECCEL** slider towards soft for slower deceleration, or towards hard for faster deceleration.
- d. Specify whether to apply the acceleration and deceleration values across all axes:
  - To apply the values across all axes, select the **Link accel and decel across axes** box.
  - To apply the values only to the selected axis, clear the **Link accel and decel across axes** box.



8. In the **On Preset Recall** area, specify whether you want each of the listed camera settings to be recalled at the start of **CUE**, **CUT**, and **RUN** operations.

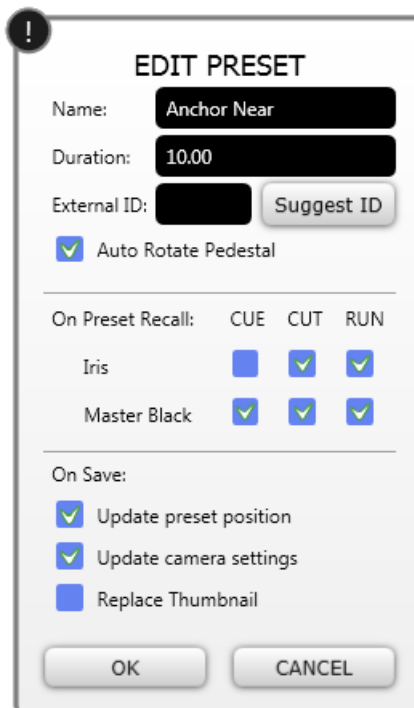
**Note:** The **On Preset Recall** area is present only if the camera is configured for recall of paint settings.

**Note:** Options in the **On Preset Recall** area do not cause current camera settings to be saved. They only enable you to specify when saved camera settings are to be applied. 10 describes how to update the saved camera settings.

9. If you want to change the position defined for the preset, manually position all controllable axes of the camera exactly where you want them to be for the preset, and then in the **On Save** area select the **Update preset position** check box.  
**Tip:** Use the **Axis Control** panel or the joystick panel to manually position the camera. For more information, see “**Manual Operation in SmartShell**” on [page 139](#).
10. If you want to update the saved camera settings (such as **Iris** position, **Master Black** level, etc), in the **On Save** area select **Update Camera Settings**.  
**Note:** The **Update Camera Settings** option is present only if the camera is configured for recall of paint settings.
11. If you want to replace the thumbnail image with a current view from the camera, in the **On Save** area select the **Replace Thumbnail** check box.  
**Note:** This option is available only if your Ross Robotics system is configured to include thumbnails.
12. Tap **OK** to apply the changes, or **Cancel** to abandon them.  
 If an error message appears, informing you that the **External ID** is not unique, specify a different ID and then tap **OK**.  
 The preset icon shows the duration and name of the preset. Optionally, a thumbnail photo taken from the destination position is also shown.

**To edit a preset for a CamBot PT head, CamBot XY pedestal running CamBot firmware, or a Vinten robot**

1. In the **Presets** panel, enable edit mode by tapping the **EDIT** button.  
 Edit mode is enabled when the **EDIT** button is highlighted blue.
2. Tap the preset you want to edit.  
 The **EDIT PRESET** dialog box appears ([Figure 28](#)).



**Figure 28** - *EDIT PRESET Dialog Box for CamBot XY Pedestal Running CamBot Firmware*

**Note:** If the title of the dialog box is **EDIT PRESET (LOCKED)**, the preset cannot be edited. You can clone the preset and then edit the cloned copy.

3. If you want to change the name of the preset, type the new name in the **Name** box.  
**Note:** Depending on how the system is configured, it may not allow the new name to be the same as the name of an existing preset and/or move.

4. If you want to specify or change the amount of time it takes for the preset to run, type a duration value, in seconds, in the **Duration** box.
 

**Tip:** Alternatively, you can use the joystick panel to adjust the duration instead of typing.

  - On the Legacy Joystick Panel, use the **TIME** knob to set the duration. Depending on how the system is configured, you may need to press and hold the ALT button while you turn the TIME knob.
  - On the CX-3R Joystick Panel use the **Duration** knob to set the duration.
5. If the **External ID** box is visible and you want to change the external ID, do one of the following:
  - To assign a particular ID, in the **External ID** box, type the ID number. The number must be unique within the category, or unique overall, depending on how your system is configured. If the number is not sufficiently unique, an error message appears when you submit the request.
  - To request that SmartShell assign an ID, tap the **Suggest ID** button. An ID number appears in the **External ID** box.
  - To delete the external ID without specifying a new one, delete the contents of the box. Deleting the ID makes the preset unavailable to the automation control system.

**Tip:** External IDs enable the automation control system to run moves and presets. The **External ID** box is visible only if your system is configured to interact with an automation control system that requires external IDs.
6. If you want the system to recall the current rotational position of the base as part of the preset, select the **Auto Rotate Pedestal** check box.
 

This option rotates the pedestal base at the end of the preset recall, aligning the wheels to a known position.

**Tip:** Use the **Auto Rotate Pedestal** option when the pedestal's next destination is known, such as for a pair of presets designed for side-to-side trucking motion. The **Auto Rotate Pedestal** option is also useful when creating a preset for the CamBot target position, because the base must be properly aligned with the target. Avoid using this option for all your presets, as it may result in unnecessary base rotation. Instead, after a preset runs, cue the next preset to rotate the base.

**Note:** The **Auto Rotate Pedestal** check box is visible only if the camera is a CamBot XY pedestal. This feature does not apply to Vinten XY pedestals.

For more information about pedestal base rotation and presets, see “**About CamBot XY Pedestals: Base Rotation, Panning, and Presets**” on [page 43](#).
7. If you want to change the position defined for the preset, manually position all controllable axes of the camera exactly where you want them to be for the preset, and then in the **On Save** area select the **Update preset position** check box.
 

**Tip:** Use the **Axis Control** panel or the joystick panel to manually position the camera. For more information, see “**Manual Operation in SmartShell**” on [page 139](#).
8. If you want to update the saved camera settings (such as **Iris** position, **Master Black** level, etc), in the **On Save** area select **Update Camera Settings**.
9. If you want to replace the thumbnail image with a current view from the camera, in the **On Save** area select the **Replace Thumbnail** check box.
 

**Note:** This option is available only if your Ross Robotics system is configured to include thumbnails.
10. Tap **OK** to apply the changes, or **Cancel** to abandon them.
 

If an error message appears, informing you that the **External ID** is not unique, specify a different ID and then tap **OK**.

The preset icon shows the duration and name of the preset. Optionally, a thumbnail photo taken from the destination position is also shown.

**For More Information About...**

- manually positioning the camera in SmartShell, see “**Manual Operation in SmartShell**” on [page 139](#)
- manually positioning the camera using the joystick panel, see “**The Joystick Panel**” on [page 90](#)
- creating moves, see “**Moves**” on [page 46](#)

# Clone a Preset

You can duplicate a preset and then edit it and/or drag it into a different preset category.

**Note:** If you clone a preset that has an external ID, edit the cloned preset to assign an external ID as required. Certain types of automation control systems require that moves and presets have external IDs. The ability to assign external IDs is available only if your Ross Robotics system is configured to interact with a control automation system that requires them.

## To clone a preset:

1. In the **Presets** panel, enable cloning by tapping the **CLONE** button.  
Cloning is enabled when the **CLONE** button is highlighted blue.

2. Tap the preset you want to duplicate.  
The **DUPLICATE PRESET** dialog box appears.

3. Type a name for the new preset, and then tap **OK**.

**Note:** Depending on how the system is configured, it may not allow the new name to be the same as the name of an existing preset and/or move.

The copied preset appears in the same preset category as the original.

## For More Information About...

- editing presets, see “**Edit a Preset**” on [page 31](#)

# Update a Preset Position

You can quickly update a preset to match the camera’s current physical position (pan, tilt, lift, XY, and track axes) without having to review or update any other properties of the preset.

Updating a preset position changes it permanently in the **Presets** panel, on Matrix buttons (including macros), and in moves.

**Note:** You cannot update the position of a locked preset. Icons for locked items have a lock symbol. For more information about locked items, see “**Locking Presets and Moves**” on [page 74](#).

**Tip:** If you want to precisely adjust only the focus, you can use the **Quick Focus** feature. For more information, see “**Using Quick Focus to Fine-Tune the Focus**” on [page 141](#).

**Tip:** If you want to modify additional properties of a preset, use the **EDIT** button. For more information, see “**Edit a Preset**” on [page 31](#).

**Tip:** If your system includes thumbnail images, the thumbnail may be automatically updated, depending on how your system is configured. If the thumbnail is not automatically updated and you need to update it, use the **EDIT** button. For more information, see “**Edit a Preset**” on [page 31](#).

## To update a preset:

1. Move the camera into the position you want to use as the preset.

2. In the **Presets** panel, enable update mode by tapping the **UPDATE** button.  
Update mode is enabled when the **UPDATE** button is highlighted blue.

3. Tap the preset you want to update.

4. If a message appears, asking you to confirm that you want to update the preset, tap **YES**.  
The preset is updated.

## For More Information About...

- editing presets, see “**Edit a Preset**” on [page 31](#)

# Delete a Preset

You can delete individual presets, or drag multiple presets into an unwanted category and delete them all at once.

When you delete a preset, it is permanently deleted everywhere it is used, including the **Presets** panel, and on Matrix buttons (including macros).

**Note:** You cannot delete a preset that is used by a move.

**Note:** You cannot delete a locked preset. Icons for locked items have a lock symbol. For more information about locked items, see **“Locking Presets and Moves”** on [page 74](#).

**Note:** If you delete a preset that is used by a Matrix button, the Matrix button is shown as “DELETED” ([Figure 29](#)). There is no advance warning that the preset is used by a Matrix button. We recommend you keep your presets, categories, and matrices well organized to help prevent problems.



*Figure 29 - Matrix Button After its Preset has been Deleted*

## To delete a preset:

1. In the **Presets** panel, enable delete mode by tapping the **DELETE** button. Delete mode is enabled when the **DELETE** button is highlighted blue.
2. Tap the preset you want to delete.
3. If a message appears, stating that the preset is in use, you cannot delete it unless you first delete it from all moves that use it. Do one of the following:
  - If you want to delete the preset from the moves that use it, tap **COPY** to copy the message details, click **OK**, paste the text into a text editor, and then refer to the information to find and edit the moves. Skip the remaining steps of this procedure.
  - If you want to cancel your request to delete the preset, click **OK**. The request to delete the preset is canceled. Skip the remaining steps of this procedure.
4. In the **CONFIRM DELETE** dialog box, tap **YES**.

## To delete multiple presets

1. Create a new category.
2. Drag the unwanted presets and all moves that use them into the new category.
3. Delete the new category.  
For more information, see **“Delete a Category”** on [page 28](#).

# Recall a Preset

When you recall a preset, the camera moves to the position defined in the preset.

Before you recall a preset, it is important to know whether the video output from the camera you are about to move is currently on-air. If your system includes tally integration, on-air status is indicated by a red dot in the **Camera Selection** panel. The joystick button for the camera is also red.

Before you recall a preset, in the **Camera Selection** panel, tap the camera you want to control.

This section contains the following topics:

- “Cut to a Preset” on [page 39](#)
- “Cue a Preset for a CamBot XY Pedestal (prepare for an on-air shot)” on [page 39](#)
- “Run (recall) a Preset Using its Defined Duration” on [page 40](#)
- “Run a Preset Using an Alternative Duration” on [page 40](#)
- “Change the Speed (duration) of a Preset During Recall:” on [page 41](#)
- “Manually Control a Camera During Preset Recall” on [page 41](#)
- “Encountering an XY (floor) Limit During Preset Recall” on [page 42](#)

**Note:** If you want to stop the selected camera at any time, tap its **HALT** button. To stop all cameras, tap **STOP ALL**.

## Cut to a Preset

When you cut to a preset, all axes move to their preset destination positions as quickly as possible. Some may reach their destinations before others.

**To cut to a preset:**

1. In the **Presets** panel, tap the **CUT** button to enable cut mode.  
**Tip:** Cut mode is enabled when the **CUT** button is blue.
2. If you want to use the alternative cue/cut speed feature to reduce the speed of robotic motion, press and hold the **ALT** key on the computer keyboard while you perform the next step.  
For more information about alternative cue/cut speed, see “**Alternative Cue/Cut Speed**” on [page 42](#).
3. Tap the preset to which you want to cut.  
**Note:** Cutting to a preset overrides the preset’s defined values for duration, acceleration rate, and deceleration rate.  
**Note:** Some Ross Robotics systems are configured to prevent cues and cuts while the selected system is on-air. If the **CUT** button is unavailable, the camera is on-air and you cannot cut to the preset until the camera is off-air.

## Cue a Preset for a CamBot XY Pedestal (prepare for an on-air shot)

When you cue a preset for a CamBot XY Pedestal, the pedestal base rotates to align its wheels with the preset’s destination position.

Cueing a preset in advance enables the pedestal to start moving towards the destination as soon as you run the preset.

**Tip:** We recommend always cueing CamBot XY presets before recalling them, even if they require no XY (floor) movement. Sometimes the base rotates when cueing such presets, to ensure that after the preset you can manually pan at least 20° in each direction. This panning buffer may be less than 20° in some cases.

**Note:** Cueing presets does not apply to Vinten robots, even though the **CUE** button appears as available.

**To cue a preset for a CamBot XY pedestal:**

1. In the **Presets** panel, tap the **CUE** button to enable cue mode.  
**Tip:** Cue mode is enabled when the **CUE** button is blue.
2. If you want to use the alternative cue speed feature to reduce the speed of base rotation during cueing, press and hold the ALT key on the computer keyboard while you perform the next step.

For more information about alternative cue speed, see “**Alternative Cue/Cut Speed**” on [page 42](#).

3. Tap the preset you want to cue.

**Note:** Some Ross Robotics systems are configured to prevent cues and cuts while the selected system is on-air. If the **CUE** button is unavailable, the camera is on-air and you cannot cue the preset until the camera is off-air.

**Tip:** In the **Presets** panel, buttons for cued presets have green borders.

## Run (recall) a Preset Using its Defined Duration

When you run a preset, the speed of each axis is scaled so that all axes reach their destination positions at the same time.

If the camera system is a CamBot XY Pedestal, the pedestal base may rotate at the start of the recall operation, unless the preset has been cued. For more information, see “**Cue a Preset for a CamBot XY Pedestal (prepare for an on-air shot)**” on [page 39](#).

### To run (recall) a preset using its defined duration:

1. In the **Presets** panel, tap the **RUN** button to enable run mode.

**Tip:** Run mode is enabled when the **RUN** button is blue.

2. If the camera is a CamBot XY pedestal and the preset has not been cued, you can use the alternative cue speed feature to reduce the speed of base rotation during the cueing phase of the preset recall. To invoke the alternative cue speed, press and hold the **ALT** key on the computer keyboard while you perform the next step.

For more information about alternative cue speed, see “**Alternative Cue/Cut Speed**” on [page 42](#).

3. Tap the preset you want to run.

If the preset cannot be run in the allotted time, one of the following occurs:

- If the camera is a CamBot or Vinten robot, the preset runs as quickly as possible. No error message appears.
- If the camera is a Furio robot, the preset may run as quickly as possible, or the **RUN PRESET FAILED** message may appear, depending on how SmartShell is configured.

If the **RUN PRESET FAILED** message appears, a minimum valid duration value appears in the **ALT** text box. Do one of the following:

- › To recall the preset using the minimum duration value, enable **ALT** mode and then tap the preset.
- › To recall the preset with a longer duration value, type a higher value in the **ALT** text box, enable **ALT** mode, and tap the preset.

**Tip:** Alternatively, you can use the **TIME** knob on the joystick panel to set the duration, instead of typing. Depending on how the system is configured, you may need to press and hold the **ALT** button while you turn the **TIME** knob.

**Tip:** Alternatively, you can use the joystick panel to adjust the duration instead of typing.

- On the Legacy Joystick Panel, use the **TIME** knob to set the duration. Depending on how the system is configured, you may need to press and hold the **ALT** button while you turn the **TIME** knob.
- On the CX-3R Joystick Panel use the **Duration** knob to set the duration.

## Run a Preset Using an Alternative Duration

When you run a preset using an alternative duration, you specify the duration before running the preset.

If the camera system is a CamBot XY Pedestal, the pedestal base may rotate at the start of the run operation, unless the preset has been cued. For more information, see “**Cue a Preset for a CamBot XY Pedestal (prepare for an on-air shot)**” on [page 39](#).

### To run a preset using an alternative duration:

1. In the **Presets** panel, in the **ALT** text box, type the duration, in seconds.  
**Tip:** Alternatively, you can use the **TIME** knob on the joystick panel to set the duration, instead of typing. Depending on how the system is configured, you may need to press and hold the **ALT** button while you turn the **TIME** knob.
2. Tap the **ALT** button to enable ALT mode.  
**Tip:** ALT mode is enabled when the **ALT** button is blue.  
**Tip:** Alternatively, you can use the joystick panel to adjust the duration instead of typing.
  - On the Legacy Joystick Panel, use the **TIME** knob to set the duration. Depending on how the system is configured, you may need to press and hold the ALT button while you turn the **TIME** knob.
  - On the CX-3R Joystick Panel use the **Duration** knob to set the duration.
3. If the camera is a CamBot XY pedestal and the preset has not been cued, you can use the alternative cue speed feature to reduce the speed of base rotation during the cueing phase of the preset recall. To invoke the alternative cue speed, press and hold the **ALT** key on the computer keyboard while you perform the next step.  
For more information about alternative cue speed, see **“Alternative Cue/Cut Speed”** on [page 42](#).
4. Tap the preset.  
If the preset cannot be run in the allotted time, one of the following occurs:
  - If the camera is a CamBot or Vinten robot, the preset runs as quickly as possible. No error message appears.
  - If the camera is a Furio robot, the preset may run as quickly as possible, or the **RUN PRESET FAILED** message may appear, depending on how SmartShell is configured.  
If the **RUN PRESET FAILED** message appears, a minimum valid duration value appears in the **ALT** text box. Do one of the following:
    - › To run the preset using the minimum duration value, tap the preset.
    - › To run the preset with a longer duration, specify a higher duration value in the **ALT** text box, and then tap the preset.

## Change the Speed (duration) of a Preset During Recall:

Changing the speed of the preset while it is being recalled is also known as time dilation.

### To change the speed (duration) of a preset during recall:

1. If the camera is not selected, select it.
2. On the **Legacy Joystick Panel**, turn the **TIME** knob clockwise to increase the duration, or counter-clockwise to decrease it.  
**Note:** Depending on how the system is configured, you may need to press and hold the ALT button while you turn the **TIME** knob.  
On the **CX-3R Joystick Panel**, roll the **Active Duration** roller upwards to increase the duration, and downwards to decrease it.  
The updated duration appears on the progress bar at the bottom of the main SmartShell window. You can prolong the preset up to ten times its original duration, or shorten it to as little as half its original duration.  
The degree to which you can shorten the duration may be limited by the physical capabilities of the system. Robotic axes always remain within defined limits for acceleration rate, speed, and deceleration rate.

## Manually Control a Camera During Preset Recall

Using the joystick panel, you can control one or more axes manually while a preset is being recalled.

Manual movements are applied cumulatively, as offsets, to the preset's destination. For example, if recalling a preset for a Furio dolly would normally extend the lift column 30 cm (12 inches), but you manually extend it an extra 15 cm (6 inches) as soon as the preset starts, then the column continues to extend from that point. When the preset is complete, the column will have extended a total of 45 cm (18 inches) unless it reaches its axis limit earlier. Robotic axes always remain within defined axis limits.

**To manually control a camera during preset recall:**

1. If the camera is not selected, select it.
2. Use the joystick panel to manually control one or more axes as required.

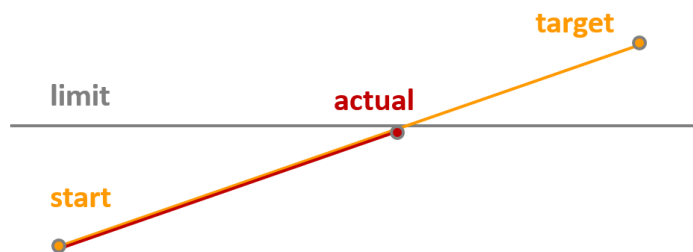
For more information about using the joystick panel, see **"Joystick Panel Controls"** on [page 91](#).

## Encountering an XY (floor) Limit During Preset Recall

If a preset for a CamBot XY pedestal specifies an XY (floor) destination that is beyond the XY limits of the pedestal, the preset can be recalled but the XY trajectory is aborted when the XY axis reaches a limit.

As the XY pedestal approaches an X-axis limit or Y-axis limit, it slows down and stops at the limit.

[Figure 30](#) illustrates the behavior of an XY pedestal as it encounters an XY limit while recalling a preset.



**Figure 30** - XY Pedestal Behavior when Encountering an XY (floor) Limit while Recalling a Preset

## Alternative Cue/Cut Speed

Normally, when a camera system cues a move or cuts to a preset, it moves as quickly as possible to the required position.

When you perform a cut to preset or an action that requires cueing, you can opt to use a predetermined alternative cue/cut speed instead of the maximum speed. The slower alternative speed may reduce the distraction some people experience when robots move quickly.

For example, when you cue and run a preset for a CamBot XY pedestal, the pedestal cues by rotating its base to align with the destination before it starts to move across the studio floor. If you use the alternative cue speed feature, the base rotates more slowly.

The alternative cue speed is a fraction of the normal speed. By default, that fraction is 1/2. The alternative cue/cut speed cannot be changed in SmartShell, but can be configured by your administrator. For more information, contact Ross Video Technical Support.

**Note:** For CamBot XY pedestals, if alternative cue/cut speed is used to recall a preset that has **Auto Rotate Pedestal** enabled, the alternative speed applies to both the initial base rotation and the rotation at the end of the recall. **Auto Rotate Pedestal** is an option that is set when a preset is created. It rotates the pedestal base at the end of the preset recall, aligning the wheels to a known position.

## How to Invoke the Alternative Cue/Cut Speed

You can invoke the alternative cue/cut speed when you cut to a preset, cue a move, or perform an action that cues a CamBot XY pedestal.

Alternative cue speed can be applied to the following types of actions:

- Cutting presets for any camera system, in the **Presets** panel or in the **Matrix** view.
- Cueing, cutting, or running presets for CamBot XY pedestals, in the **Presets** panel or in the **Matrix** view. This includes running presets using an alternative duration.
- Cueing moves for any camera system, in the **Moves** panel or in the **Matrix** view.

### To invoke the alternative cue/cut speed:

1. In SmartShell, tap the button corresponding to the type of action you want to perform, to enable the appropriate mode (**CUE**, **CUT**, **RUN**, **ALT**).  
**Tip:** A mode is enabled when its button is blue.
2. On the computer keyboard, press and hold the **ALT** key, and then tap the button corresponding to the move, preset, or Matrix action you want to cue or cut.

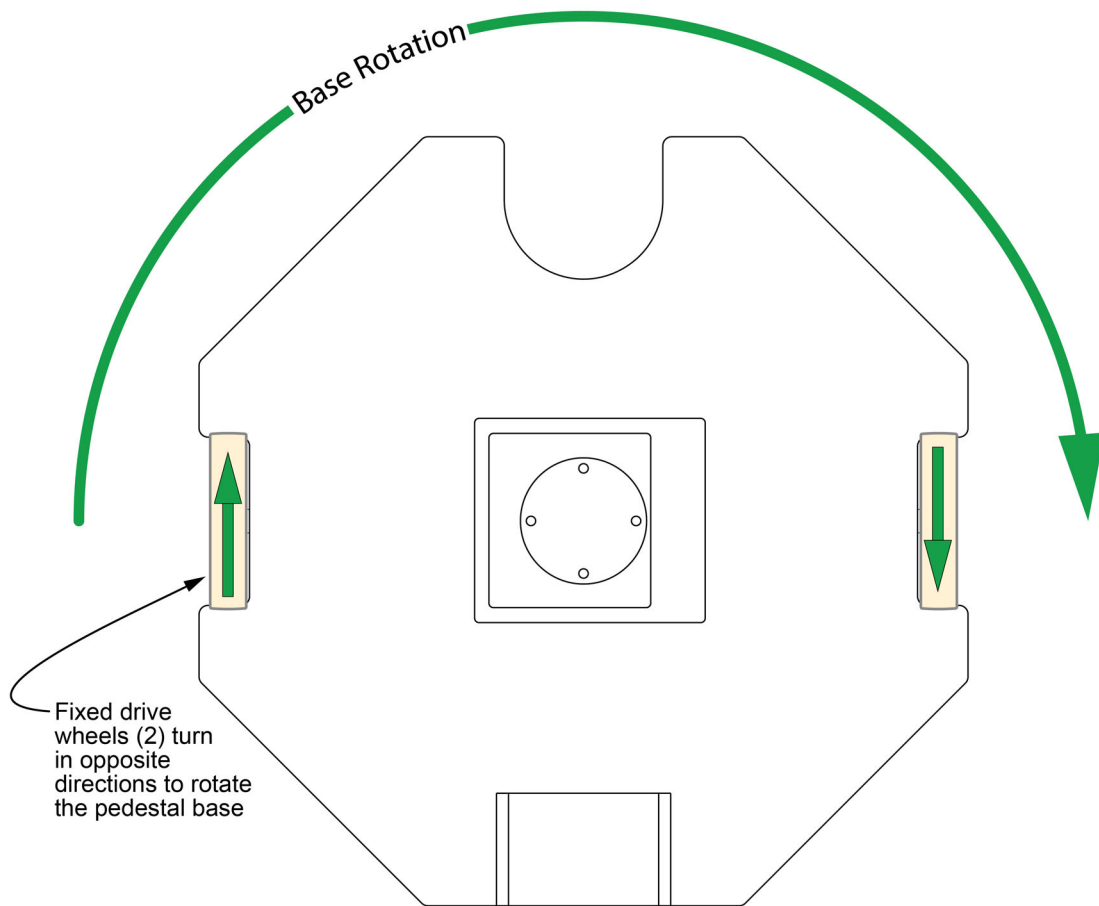
## About CamBot XY Pedestals: Base Rotation, Panning, and Presets

When operating a CamBot XY pedestal, it's important to understand the interaction between pedestal base rotation, head panning movement, and presets.

This section describes some characteristics of CamBot XY pedestal movement, and provides recommendations about how to get the best results when creating presets for them.

### Relationship Between Base Rotation and the Pan Axis

CamBot XY pedestals feature a unique two-wheeled differential drive system that provides industry-leading floor accuracy. Instead of swiveling motorized casters to change direction, CamBots counter-rotate their two fixed drive wheels to steer the base ([Figure 31](#)). The drive wheels are not on casters.

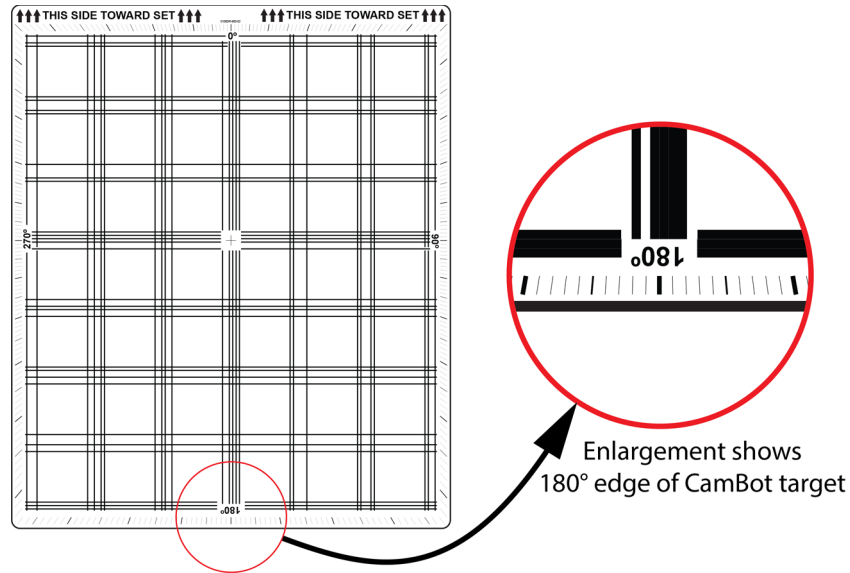


**Figure 31** - Outline of a CamBot XY pedestal base. Fixed drive wheels (yellow) turn in opposite directions to rotate the base.

When a preset that requires XY (floor) motion is recalled, the robot prepares itself to drive to the destination position. Unless the wheels are already pointing in the required direction, they turn in opposite directions to rotate the pedestal base. As the base rotates, the robotic head pans in the opposite direction to keep the camera view locked on its current framing.

Base rotation and pan range are limited in order to prevent cables becoming wrapped tightly around the robot. During preset recall, the base can rotate to anywhere within a range of approximately  $\pm 180^\circ$  from its 0 position. The panning range of the head is approximately  $\pm 358^\circ$  (CamBot 700 series) or  $\pm$

178° (CamBot 600 series). These pan ranges are relative to the base. Pan values displayed in SmartShell are absolute, i.e. relative to the CamBot target (Figure 32).



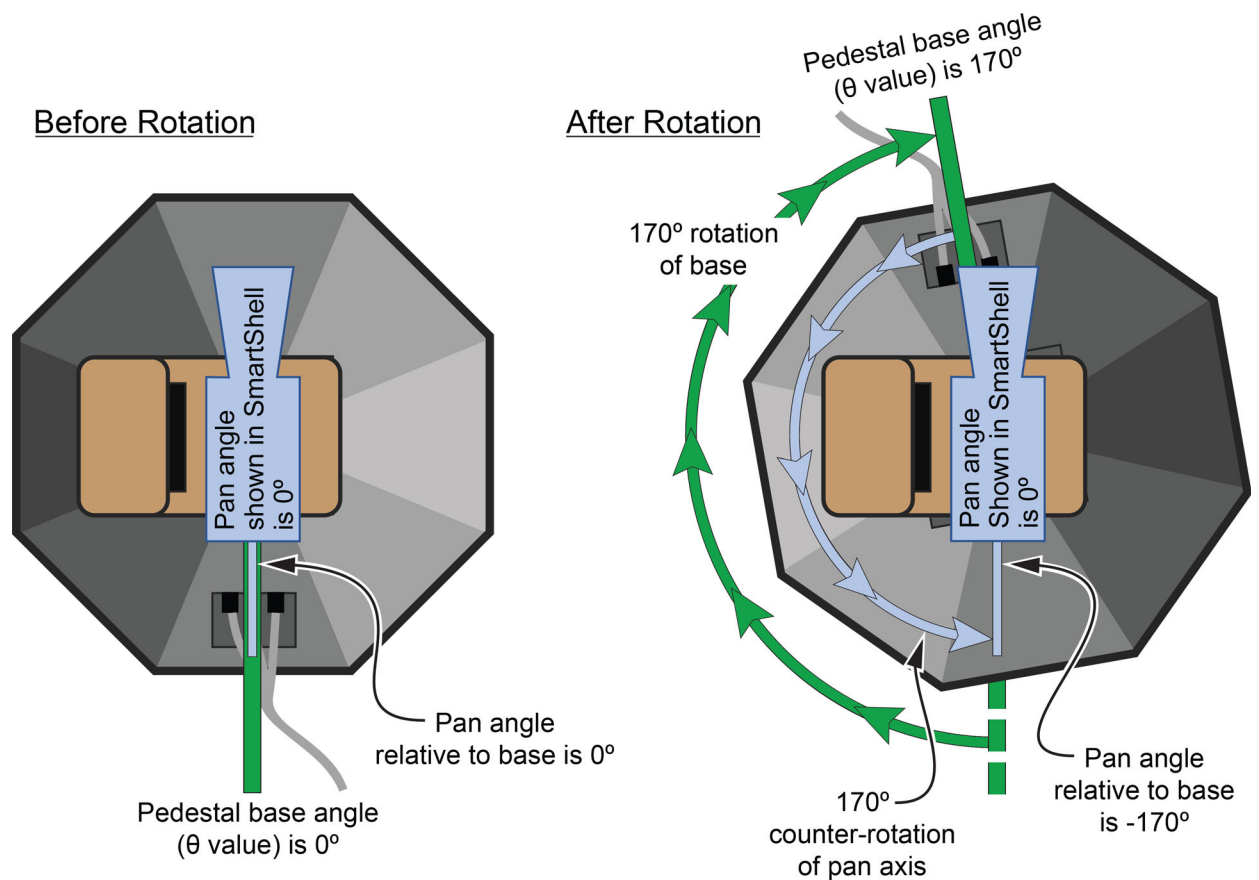
**Figure 32** - CamBot calibration target, showing the position of the 180° edge

## Pan Range Limitations

The robotic head is mounted on the top of the pedestal base, so the ability to pan in a given direction may sometimes be limited due to the rotational position of the base.

In the example shown in [Figure 33](#), the base of a CamBot 600XY rotates 170° clockwise and the head automatically pans 170° counter-clockwise to maintain the camera's current framing. Because the pan range of a 600-series head is +/- 178°, the head can then pan only an additional 8° counter-clockwise before it reaches the end of its pan range. A 700 series head has a greater pan range so it can pan farther.

**Tip:** The **Pan** axis angle displayed in SmartShell is relative to the orientation of the CamBot target on the studio floor, not relative to the pedestal base.



**Figure 33** - This example shows the relationship between base rotation and the pan axis. When the base rotates 170° clockwise, the head automatically pans 170° counter-clockwise to maintain a constant absolute camera angle. If the head is a CamBot 600-series model, the pan axis has a limit of +/- 178° and therefore can pan no more than an additional 8° counter-clockwise from the position shown at right.

If the head reaches the end of its pan range while the pedestal base continues to rotate, the head starts to rotate along with the base, and camera framing is lost. This occurs only if both the base and the head are rotated very far from their home positions.

The 600-Series head is limited to a +/-178° range, which can necessitate lengthy pan movements. For example, if the head pan position is +170° relative to the target, in order to pan to an angle of -170° the head must pan the long way (-340° travel), instead of the short way (+20° travel). This problem can easily be avoided by ensuring that the base orientation allows the head to pan as required. The 700 series head has a +/- 358° pan range, so it doesn't have this limitation.

## Manual Panning After Recalling a Preset

Sometimes the subject isn't exactly in the expected position. To frame them properly after recalling a preset, manual panning may be required.

The CamBot XY pedestal is programmed to ensure that, whenever possible, you can pan at least 20° in either direction after a preset is recalled. This panning buffer may be less than 20° in some cases.

- For presets that do not involve XY (floor) motion, the base rotates, if required, during cueing or at the start of the preset.
- For presets that involve XY motion, the pedestal base rotates, if required, to point the wheels in the required direction. The CamBot determines whether to rotate the base clockwise or counter-clockwise. If one direction would yield less than 20° of pan freedom, the base rotates the other way.

## Recommendations

**For best results when using a CamBot XY pedestal, especially with a 600 series head:**

- If possible, position the CamBot target such that its 180° edge ([Figure 32](#)) points toward an area you do not intend to show on-air. This ensures maximum flexibility in terms of panning and the ability to recall presets more quickly.
- To reduce overall pedestal base rotation, avoid using the **Auto Rotate Pedestal** feature every time you create or edit a preset. Instead, cue each preset immediately before you run it.

**Tip:** Select the **Auto Rotate Pedestal** option when you save a preset at the target position, to ensure that when you recall the preset, the pedestal base is properly aligned with the target.

- Cue presets before recalling them, especially if you want to put a moving camera on-air. If the preset requires the pedestal base to rotate, cueing achieves this in advance of preset recall. If you do not cue a preset that requires the base to rotate, it rotates at the start of the preset, introducing a delay between the time the preset is recalled and when the other axes start moving. The rotation can also cause the camera to shake due to rapid rotation of the base.
- Before saving a preset with the **Auto Rotate Pedestal** option selected, we recommend that you ensure the pedestal base theta ( $\Theta$ ) value shown in SmartShell is within +/- 90° of its home orientation of 0°. This reduces overall base rotation. For information about viewing the current theta ( $\Theta$ ) value in the **Axis Control** panel in SmartShell, see “**Axis Configuration**” on [page 111](#).

**Tip:** When the pedestal base is in its home orientation, its connection panel points in the same direction as the rear of the CamBot floor target (labeled **180°**).

# Moves

A move is a series of presets on a timeline. For each preset in the move, the time at which the preset position is reached (also called distance) is defined. The combination of a preset and distance in a move is called a keyframe. When a move is recalled, the camera proceeds from the first preset position, through each of the others, to the last. For each keyframe, the camera reaches the associated preset position at the time specified by the keyframe's distance.

**Note:** Only certain robotic cameras systems (cameras) can perform moves. Furio robots and CamBot XY pedestals can perform both moves and presets. Standalone CamBot Pan & Tilt robotic heads can perform only presets. When SmartShell controls a robot that cannot perform moves, the **Moves** panel is not shown, and the **Presets** panel is enlarged.

**IMPORTANT:** A CamBot XY pedestal can perform moves only if it is running Furio firmware version 5.2 or higher. CamBot XY pedestals running older CamBot firmware can be upgraded to run newer firmware. For more information, contact Ross Video Technical Support.

This section includes the following topics:

- “**Understanding Moves**” on [page 46](#)
- “**Moves Panel Icons**” on [page 47](#)
- “**Move Categories**” on [page 48](#)
- “**Create a Move**” on [page 51](#)
- “**Create a Keyframe by Dragging a Preset into a Move**” on [page 52](#)
- “**Create a Keyframe Dynamically**” on [page 54](#)
- “**Edit a Keyframe**” on [page 57](#)
- “**Delete a Keyframe**” on [page 59](#)
- “**Record Axis Movement**” on [page 60](#)
- “**Enabling and Disabling Preset Data for Individual Axes within a Keyframe**” on [page 61](#)
- “**Clone a Move**” on [page 62](#)
- “**Edit a Move**” on [page 62](#)
- “**Create a Looped Move**” on [page 63](#)
- “**Verify and Correct a Move**” on [page 64](#)
- “**Cue and Run a Move**” on [page 67](#)
- “**Delete a Move**” on [page 68](#)
- “**Encountering an XY (floor) Limit During Move Recall**” on [page 69](#)

## Understanding Moves

This section describes how Ross Video robots process and recall moves.

When recalling a move, the robot handles each axis independently. For each axis, the system calculates the required position/velocity profile of the axis to ensure each keyframe position is reached at the specified time. The position/velocity profile includes the position, speed, and direction of the axis at any given time during the move.

To calculate the position/velocity profile, the robot analyzes the move per axis by scanning through the list of keyframes in the move. If an axis is enabled in a keyframe, its position and distance are taken into account. If an axis is not enabled in a keyframe, the position and distance for that axis in that keyframe are ignored and do not influence the move. This analysis results in an array of positions and associated distances per axis. To avoid confusing the elements in this array with keyframes, these elements will be called **steps** in the following paragraphs.

In the next phase, the robot analyses the position/distance array and calculates the required velocity of the axis at each step. The velocity at the first and last steps is always zero. The velocity of a purely linear axis (all except the XY (floor) axis for CamBot pedestals, which can perform curved motion) is also zero for steps at which the direction of movement along the axis reverses. For example, if the first and third steps have the same position, the axis reverses direction at the second step. The camera system moves from the first step position to the second step position, and then stops before reversing direction and moving to the third step position.

For all other steps, linear axes do not stop at the step position, but smoothly pass through the position at the required time. The velocity at the step position is calculated by taking into account the acceleration rate, deceleration rate, and distance of the step and its surrounding steps.

For CamBot XY pedestal moves, each keyframe has a **Tension** value associated with the XY (floor position) axis. The **Tension** value defines the degree to which the pedestal maintains a straight path as it approaches the keyframe position, as opposed to traveling a curved path. With all keyframes set to the highest **Tension** value (**100**), the pedestal travels directly from one keyframe position to the next, pausing briefly at each to rotate the pedestal base as required. Using lower **Tension** values, you can achieve a smooth, curving trajectory throughout the move, with no pauses in XY movement for pedestal rotation. By default, the **Tension** value is set to a value of **80**.

If a preset for a CamBot XY pedestal specifies an XY (floor) destination that is beyond the XY limits of the pedestal, the preset can be recalled but the XY trajectory is automatically adjusted to keep the robot within its XY limits. For more information, see “**Encountering an XY (floor) Limit During Move Recall**” on [page 69](#).

For several reasons, a programmed move may not be physically possible. Each axis has a maximum velocity defined by system limitations. The acceleration and deceleration values can be defined by the operator, within the limit of a maximum value. A move is physically impossible if the distance (time) between steps is too small. In such cases, reaching the next step would mean either exceeding the maximum velocity or exceeding the defined acceleration/deceleration limits. To ensure the safety of the system, the robot refuses to perform moves that are outside the limitations of the system.

## Moves Panel Icons

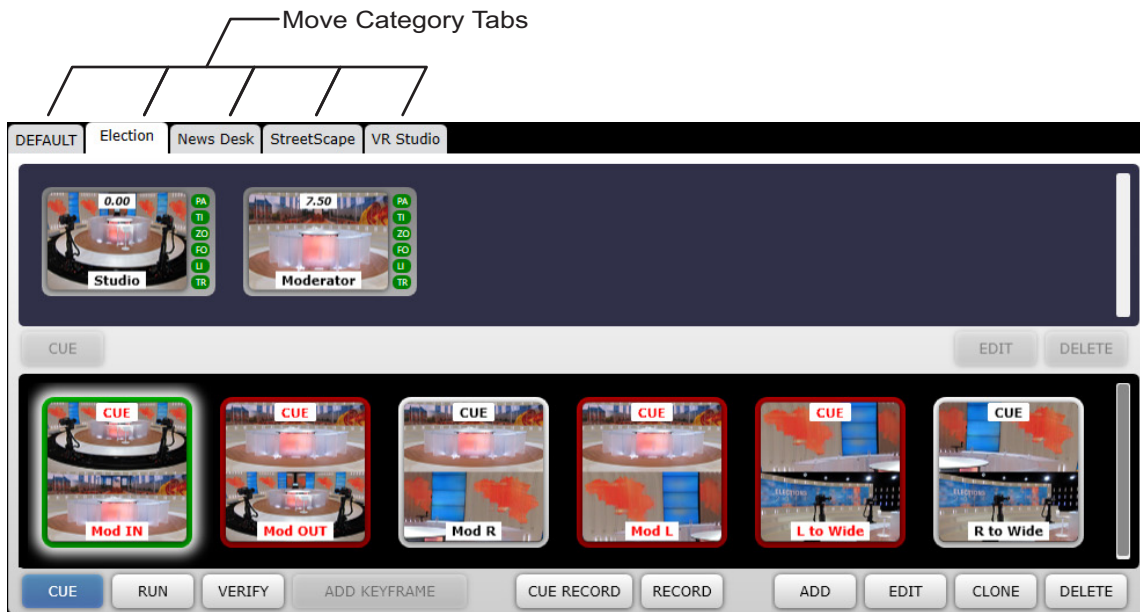
In the **Moves** panel, each move icon is color-coded to indicate the status of the move:

- **white glow surrounding the icon** — This is the selected move.
- **light gray border** — The move is valid, but it must be cued before you run it.
- **green border** — The move has been cued, and is ready to run.
- **orange border** — An attempt to cue the move was not successful. The move will be run from the current position.
- **dark blue border** — The move is the most recently recalled move and the robot is still in the destination position.
- **light blue border** — The move is the most recently recalled move, but the robot’s position has changed by joystick control since the move was recalled.
- **red border and red text** — The move is invalid.

A move is invalid if the allotted time between two keyframes is not long enough for the camera to move where required. An invalid move can be cued, but not run.

# Move Categories

In the **Moves** panel, moves are arranged on category tabs (Figure 33). You can sort moves, drag moves between categories, add new categories, clone categories, rename categories, and delete categories.



*Figure 33 - Category Tabs in the Moves Panel*

You can use categories to group presets and moves related to a particular purpose or show.

There is always at least one category. The **DEFAULT** category is always present.

**Note:** Move categories and preset categories are linked. If you add, clone, rename, or delete a move category, the same action is performed on the identically-named preset category. Move categories exist only for cameras that can perform moves.

## Sort Moves and Presets

When you sort, all moves and presets in all categories are sorted.

### To sort moves:

1. Touch and hold a location on the **Moves** panel until a circle appears, and then release it.  
**Tip:** If you are using a mouse, right-click an empty area of the **Moves** panel. The sort menu appears.
2. In the sort menu, tap one of the following:
  - **Name (A->Z)**, to sort alphabetically.
  - **Name (Z->A)**, to sort reverse-alphabetically.
  - **Date (Old->New)**, to sort by order of creation, from oldest to newest.
  - **Date (New->Old)**, to sort by order of creation, from newest to oldest.

## Drag a Move to a Different Category

### To drag a move from one category to another:

- In the **Moves** panel, drag the move icon to the destination category tab.

## Add a Category

When you add a category to the **Moves** panel, an identically-named category is also added to the **Presets** panel. These categories are linked, so when you rename or delete one, the other is also renamed or deleted.

### To add a category:

1. In the **Moves** panel, touch and hold any category tab until a circle appears, and then release it.  
**Tip:** If you are using a mouse, right-click any category tab.
2. On the category menu, tap **Add New Category**.
3. Type a name for the category and then tap **OK**.  
**Tip:** Depending on how your system is configured, a unique category name may be required.

## Rename a Category

Identically-named preset and move categories are linked. When you rename one, both are renamed.

### To rename a category:

1. In the **Moves** panel, press and hold the category tab until a circle appears, and then release it.  
**Tip:** If you are using a mouse, right-click the category tab.
2. On the category menu, tap **Rename Category**.
3. Type a new name for the category, and tap **OK**.

## Clone a Category

You can clone a move category to make a copy of it, and then modify it as needed.

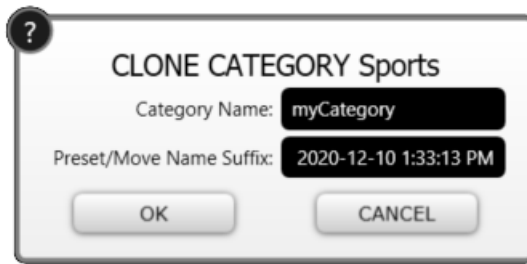
Preset categories and move categories are linked. When you clone a category from either the **Presets** panel or the **Moves** panel, the identically-named category in the other panel is also cloned.

**Note:** If you clone a category that contains moves which reference presets from other categories, the referenced presets are cloned. For example, if a move in Category A uses a preset from Category B, and you clone Category A, the **Presets** panel in the new category contains a clone of the Category B preset. There is no link between the new preset and the original.

**Note:** If you clone a category that has moves or presets with external IDs, edit the cloned moves or presets to assign external IDs as required. Certain types of automation control systems require that moves and presets have external IDs. The ability to assign external IDs is available only if your Ross Robotics system is configured to interact with a control automation system that requires them.

### To clone a category:

1. In the **Moves** panel, press and hold the category tab until a circle appears, and then release it.  
**Tip:** If you are using a mouse, right-click the category tab.
2. On the category menu, tap **Clone Category**.  
The **CLONE CATEGORY** dialog box appears ([Figure 34](#)).



**Figure 34** - CLONE CATEGORY Dialog Box

3. In the **Category Name** box, type a name for the new category.  
**Tip:** Depending on how your system is configured, a unique category name may be required.
4. In the **Preset/Move Name Suffix** box, type characters that you want added to the end of the preset names and move names in the new category, to make the names unique.  
**Tip:** Depending on how your system is configured, a suffix may not be required.
5. Tap **OK**.  
The category is cloned, creating a new category.

## Delete a Category

Preset categories and Move categories are linked. When you delete a category from either the **Presets** panel or the **Moves** panel, the identically-named category in the other panel is also deleted. Deleting a category also deletes all presets and moves within it.

**Note:** You cannot delete a category that contains locked moves or presets. Icons for locked items have a lock symbol. For more information about locked items, see **“Locking Presets and Moves”** on [page 74](#).

### To delete a category and all moves and presets within it:

1. In the **Moves** panel, press and hold the category tab until a circle appears, and then release it.  
**Tip:** If you are using a mouse, right-click the category tab.
2. On the category menu, tap **Delete Category**.  
The **CONFIRM DELETE** dialog box appears.
3. Depending on the message in the **CONFIRM DELETE** dialog box, do one of the following:
  - **Are you sure you want to delete category ‘name’?** — The category is empty. To delete it, tap **YES**. Otherwise, tap **NO**.
  - **Category ‘name’ cannot be deleted because it contains locked moves or presets** — You cannot delete locked items. If you want to delete the unlocked moves and presets in the category, delete them one by one. Icons for locked items have lock symbols.
  - **Category ‘name’ is not empty!** — If you want to delete the category and all the moves and presets it contains, tap **YES**. Otherwise, tap **NO**.

**Note:** If you delete a preset that is used by a Matrix button, the Matrix button is shown as **“DELETED”** ([Figure 35](#)). There is no advance warning that the preset is used by a Matrix button. We recommend you keep your presets, categories, and matrices well organized to help prevent problems.



**Figure 35** - Matrix Button After its Preset has been Deleted

4. If the **CANNOT DELETE CATEGORY** message appears, the category contains one or more presets that are in use by one or more moves in other categories. The message indicates the name of a preset that cannot be deleted.  
Move the preset into a category that is not being deleted, and then try again to delete the unwanted category.

## The Temporary Category

Depending on how your system is configured, when SmartShell starts it may create a special temporary category as a location where you can create and store new presets and moves without affecting existing categories.

The temporary category works the same as any other category, except that when you close SmartShell, you are prompted to delete or retain it.

The temporary category is especially useful if your organization maintains a standard set of Matrix files and categories with locked presets.

For example, if you load a Matrix file and you want to modify a locked preset for immediate temporary use, you can use the **ADD & ASSIGN** feature to replace the preset button in the Matrix, and store the new preset in the temporary category. In the **ADD & ASSIGN** dialog box, the temporary category is selected by default. When you close SmartShell, opt to delete the temporary category and close without saving changes to the Matrix file (**DELETE AND CLOSE**). Your changes are not saved, and the system is ready for the next user.

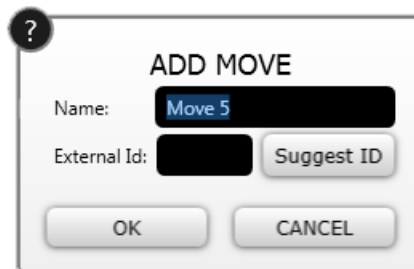
**Note:** The name of the temporary category is configured by your administrator. If you rename it, it is not deleted when SmartShell closes.

## Create a Move

When you create a move, it appears in the **Moves** panel in the current move category.

**To create a move:**

1. In the **Moves** panel, tap **ADD**.  
The **ADD MOVE** dialog box appears ([Figure 36](#)).



**Figure 36** - ADD MOVE Dialog Box

2. In the **Name** box, type a name for the new move.  
**Note:** Depending on how the system is configured, it may not allow the name of the new move to be the same as the name of an existing move and/or preset.

3. If the **External ID** box is visible and you want to make the move available to the automation control system, do one of the following:
  - To assign a particular ID, in the **External ID** box, type the ID number.  
The number must be unique within the category, or unique overall, depending on how your system is configured. If the number is not sufficiently unique, an error message appears when you submit the request.
  - To request that SmartShell assign an ID, tap the **Suggest ID** button.  
An ID number appears in the **External ID** box.

**Tip:** External IDs enable the automation control system to run moves and presets. The **External ID** box is visible only if your system is configured to interact with an automation control system that requires external IDs.
4. Tap **OK**.  
The new move appears in the **Moves** panel.
5. Create at least two keyframes in the new move by adding presets to it.

## Create a Keyframe by Dragging a Preset into a Move

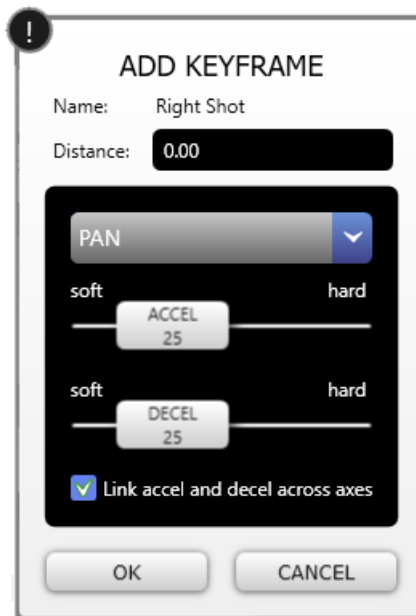
A move consists of a series of presets on a timeline. When a preset is combined with a distance (time) in a move, it is called a keyframe. You can create a keyframe by adding a preset from any category to a move.

### Notes:

- You cannot create keyframes for a locked move. Icons for locked items have a lock symbol. For more information about locked items, see “**Locking Presets and Moves**” on [page 74](#).
- If the move includes recorded axis movements, these are lost if you add a keyframe. If you attempt to add a keyframe, a confirmation dialog box appears, asking if you want to proceed. For more information about recording axis movements, see “**Record Axis Movement**” on [page 60](#).

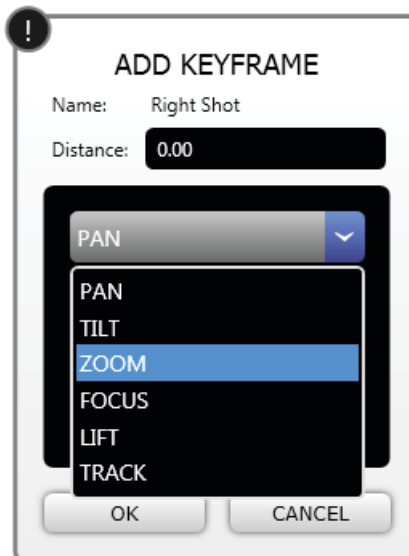
### To create a keyframe:

1. In the **Moves** panel, tap the move in which you want to create a new keyframe.
2. Drag a preset from the **Presets** panel to the **Moves** panel, and then drop it into the keyframes area.  
**Tip:** As you hover over the keyframes area, a vertical line indicates the current drop position. The **ADD KEYFRAME** dialog box appears ([Figure 37](#)).



**Figure 37** - ADD KEYFRAME Dialog Box

3. In the **Distance** box, type the distance for the keyframe, in number of seconds after the start of the move.  
**IMPORTANT:** The distance of the first keyframe must be **0** seconds.
4. If you want to set the acceleration rate and deceleration rate for a linear axis (pan, tilt, zoom, focus, lift, track):
  - a. In the axis list, select the linear axis you want to configure ([Figure 38](#)).



**Figure 38** - ADD KEYFRAME Dialog Box with Axis List Expanded (Furio robot)

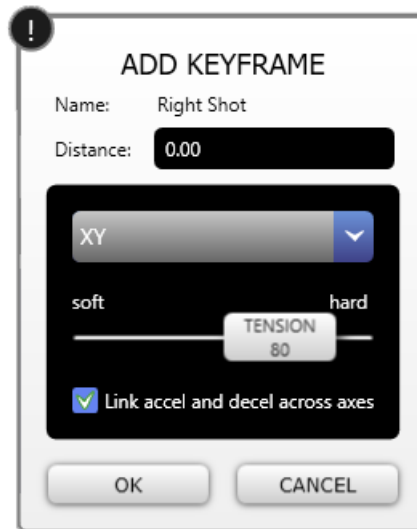
- b. To set the acceleration rate, drag the **ACCEL** slider.  
 Drag the **ACCEL** slider towards soft for slower acceleration, or towards hard for faster acceleration.  
**Tip:** When using sliders, you can tap the slider and then press the left or down arrow keys to decrease the value, or tap the right or up arrow keys to increase the value.
- c. To set the deceleration rate, drag the **DECEL** slider.

Drag the **DECCEL** slider towards soft for slower deceleration, or towards hard for faster deceleration.

- d. Specify whether to apply the acceleration and deceleration values across all axes:
  - To apply the values across all axes, select the **Link accel and decel across axes** box.
  - To apply the values only to the selected axis, clear the **Link accel and decel across axes** box.



5. If the camera system is a CamBot XY pedestal, select the **XY** axis and then set the **Tension** value:
  - a. In the axis list, select the **XY** axis ([Figure 39](#)).



**Figure 39** - ADD KEY FRAME Dialog Box with XY Axis Selected

- b. To set the curve tension, drag the **Tension** slider (**0** to **100**):

The **Tension** value defines the degree to which the pedestal maintains a straight path as it approaches the keyframe position, as opposed to traveling a curved path.

If all keyframes are set to the highest **Tension** value (**100**), the pedestal travels directly from one keyframe position to the next. It pauses briefly at each keyframe position to rotate the pedestal base, aligning the wheels with the next keyframe position. No other axes move while the pedestal base rotates.

Using lower **Tension** values, you can achieve a smooth, curving trajectory throughout the move with no pauses in XY movement for pedestal rotation. By default, the **Tension** value is set to a value of **80**.

**Tip:** When using sliders, you can tap the slider and then press the left or down arrow keys to decrease the value, or tap the right or up arrow keys to increase the value.

6. Tap **OK**.

## Create a Keyframe Dynamically

You can add one or more keyframes to a move dynamically, while the move is running. This enables you to watch the move as it progresses and insert a new keyframe at the desired moment.

When you insert a keyframe dynamically, a new preset is also created. You can edit and recall the new preset on its own, or drag it into other moves.

You can also insert a keyframe dynamically to stop one or more axes before the end of the move.

You can insert a new keyframe while all axes of the robot are moving at constant velocities, but not while the robot is accelerating or decelerating. The length of the period of constant velocity between two adjacent keyframes depends partly on how quickly each axis accelerates and decelerates, as influenced by the **ACCEL** and **DECEL** settings for the two keyframes. You can edit the keyframes to adjust the acceleration and deceleration rates of each axis. For more information, see **“Edit a Keyframe”** on [page 57](#).

**Note:** You cannot create keyframes for a locked move. Icons for locked items have a lock symbol. For more information about locked items, see **“Locking Presets and Moves”** on [page 74](#).

#### To insert a new keyframe while a move is running:

1. Cue the move and then run it.
2. Tap the **ADD KEYFRAME** button.
3. When the camera reaches the point at which you want to insert a new keyframe, tap the move icon. A new keyframe is created ([Figure 40 on page 55](#)).



**Figure 40** - New Keyframe (center), with All Axes Disabled (red axis dots) by Default

By default, all axes in the new keyframe are disabled, and the name of the keyframe includes the distance (time within the move) it was created.

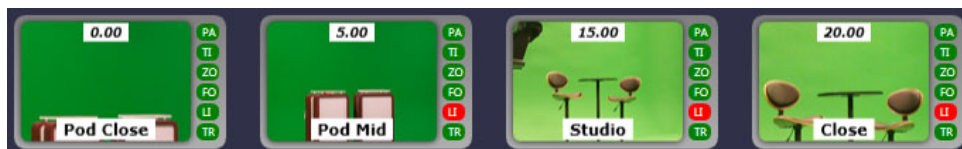
**Tip:** When you create a keyframe dynamically, the keyframe also appears as a preset in the presets panel.

4. On the new keyframe icon, enable individual axes as required. For more information, see **“Enabling and Disabling Preset Data for Individual Axes within a Keyframe”** on [page 61](#).

**Tip:** You can also edit the new keyframe to change its name, distance (time), and acceleration/deceleration characteristics. For more information, see **“Edit a Keyframe”** on [page 57](#) for more information.

#### To delay the start of an axis:

1. In the second keyframe and all subsequent keyframes of the move, disable the axis you want to delay. [Figure 41](#) shows settings for delaying the **Lift** axis.



**Figure 41** - Preparing to Delay the Start of the Lift Axis (Li dot) in a Move

For more information about disabling axes, see **“Enabling and Disabling Preset Data for Individual Axes within a Keyframe”** on [page 61](#).

Cue the move and then run it.

2. Tap the **ADD KEYFRAME** button.
3. When the camera reaches the point at which you want to start the delayed axis, tap the move icon.

A new keyframe is created.

By default, all axes in the new keyframe are disabled, and the name of the keyframe includes the distance (time within the move) it was created.

4. Enable axes as required ([Figure 42](#)):
  - a. On the new keyframe icon, enable all axes except the axis you want to delay.
  - b. On subsequent axes, enable the axis you want to delay.



*Figure 42 - A Move in which the Start of the Lift Axis is Delayed Until the Third Keyframe*

**Tip:** You can also edit the new keyframe to change its name, distance (time), and acceleration/deceleration characteristics. For more information, see **“Edit a Keyframe”** on [page 57](#) for more information.

5. Cue and run the move to test that it works as intended.

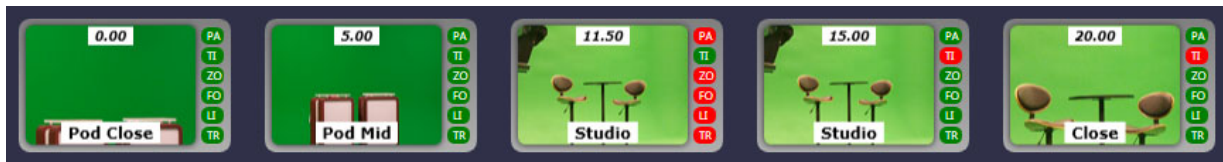
**To stop one or more axes before the end of a move:**

1. Cue the move and then run it.
2. Tap the **ADD KEYFRAME** button.
3. When the camera reaches the point at which you want to stop some axes, tap the move icon.  
A new keyframe is created.

By default, all axes in the new keyframe are disabled, and the name of the keyframe includes the distance (time within the move) it was created.

4. Enable/disable axes as follows:
  - a. In the new keyframe, enable only the axes that you want to stop early.
  - b. In all keyframes after the new one, disable the axes you want to stop early.

In [Figure 43](#), the third keyframe (at 11.50 seconds) is the new one. The **TILT** axis is set to stop at the new keyframe and remain stopped for the rest of the move. Because the other axes in the new keyframe are disabled, it has no effect on the movement of those axes.



*Figure 43 - A Move in which the Tilt Axis Stops at the Third Keyframe*

For more information, see **“Enabling and Disabling Preset Data for Individual Axes within a Keyframe”** on [page 61](#).

5. Cue and run the move to test that it works as intended.

# Edit a Keyframe

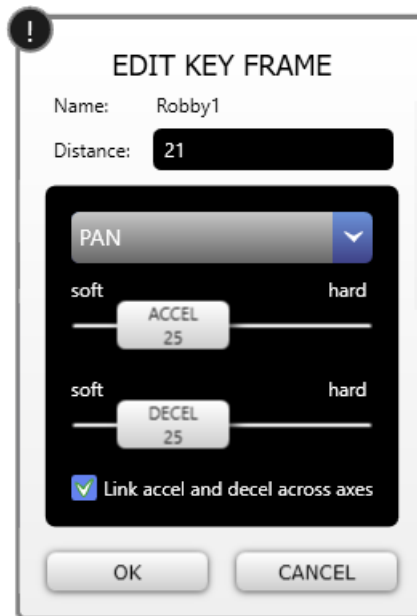
When you edit a keyframe, you can change the distance (time) at which the robot reaches the keyframe position, the acceleration and deceleration rate for each linear axis (pan, tilt, zoom, focus, lift, track), and the curve tension for the XY axis (CamBot XY pedestals only).

## Notes:

- Each keyframe is based on a preset. If you want to change the position of the robot for a keyframe, update the underlying preset. For more information, see **“Update a Preset Position”** on [page 37](#).
- You cannot edit keyframes that belong to a locked move. Icons for locked items have a lock symbol. For more information about locked items, see **“Locking Presets and Moves”** on [page 74](#).
- If the move includes recorded axis movements, these are lost if you edit a keyframe. If you attempt to edit a keyframe, a confirmation dialog box appears, asking if you want to proceed. For more information about recording axis movements, see **“Record Axis Movement”** on [page 60](#).

## To edit a keyframe:

1. In the **Moves** panel, enable edit mode by tapping the **EDIT** button. Edit mode is enabled when the **EDIT** button is highlighted blue.
2. In the **Keyframes** area of the **Moves** panel, tap the keyframe you want to edit. The **EDIT KEY FRAME** dialog box appears ([Figure 44](#)).



**Figure 44** - EDIT KEY FRAME Dialog Box

3. In the **Distance** box, type the distance (time) for the keyframe, in number of seconds after the start of the move.

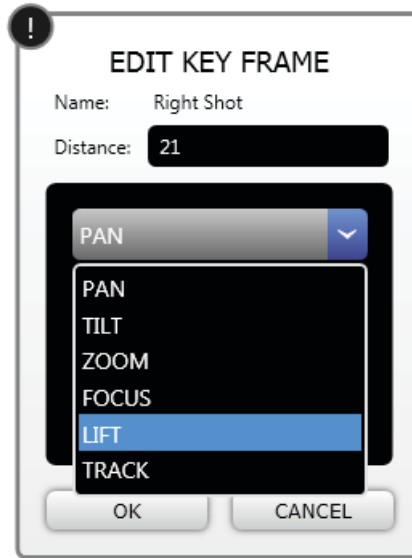
**IMPORTANT:** The distance of the first keyframe must be **0** seconds.

**Note:** If you define a distance smaller than the previous keyframe, or greater than the next keyframe, the order of keyframes changes. You may need to adjust the distance of other keyframes to maintain their order.

**Tip:** Alternatively, you can use the joystick panel to adjust the duration instead of typing.

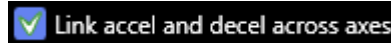
- On the **Legacy Joystick Panel**, use the **TIME** knob to set the duration. Depending on how the system is configured, you may need to press and hold the **ALT** button while you turn the **TIME** knob.
- On the **CX-3R Joystick Panel**, use the **Duration** knob to set the duration.

4. Edit the acceleration rate and deceleration rate for each linear axis (pan, tilt, zoom, focus, lift, track):
  - a. In the axis list, select a linear axis ([Figure 45](#)).

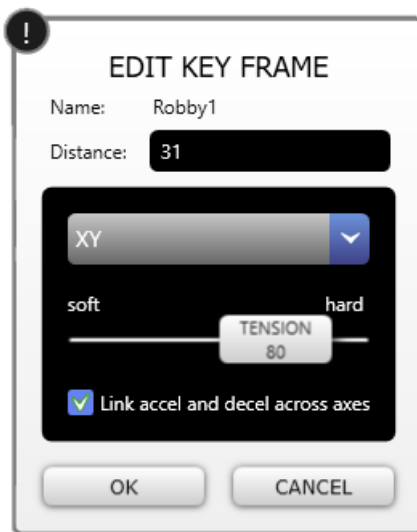


**Figure 45** - EDIT KEY FRAME Dialog Box with Axis List Expanded

- b. To set the acceleration rate, drag the **ACCEL** slider.  
Drag the **ACCEL** slider towards soft for slower acceleration, or towards hard for faster acceleration.  
**Tip:** When using sliders, you can tap the slider and then press the left or down arrow keys to decrease the value, or tap the right or up arrow keys to increase the value.
- c. To set the deceleration rate, drag the **DECEL** slider  
Drag the **DECEL** slider towards soft for slower deceleration, or towards hard for faster deceleration.
- d. Specify whether to apply the acceleration and deceleration values across all axes:
  - To apply the values across all axes, select the **Link accel and decel across axes** box.
  - To apply the values only to the selected axis, clear the **Link accel and decel across axes** box.



5. If the camera system is a CamBot XY pedestal, set the **Tension** value:
  - a. In the axis list, select the **XY** axis ([Figure 39](#)).



**Figure 46** - EDIT KEY FRAME Dialog Box with XY Axis Selected

- b. To set the curve tension, drag the **Tension** slider (**0** to **100**):

The **Tension** value defines the degree to which the pedestal maintains a straight path as it approaches the keyframe position, as opposed to traveling a curved path.

If all keyframes are set to the highest **Tension** value (**100**), the pedestal travels directly from one keyframe position to the next. It pauses briefly at each keyframe position to rotate the pedestal base, aligning the wheels with the next keyframe position. No other axes move while the pedestal base rotates.

Using lower **Tension** values, you can achieve a smooth, curving trajectory throughout the move with no pauses in XY movement for pedestal rotation. By default, the **Tension** value is set to a value of **80**.

**Tip:** When using sliders, you can tap the slider and then press the left or down arrow keys to decrease the value, or tap the right or up arrow keys to increase the value.

6. Tap **OK**.

## Delete a Keyframe

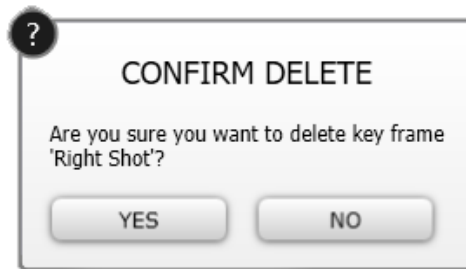
You can delete a keyframe from a move. When you delete a keyframe, the underlying preset still exists in the **Presets** panel.

### Notes:

- You cannot delete keyframes that belong to a locked move. Icons for locked items have a lock symbol. For more information about locked items, see "**Locking Presets and Moves**" on [page 74](#).
- If the move includes recorded axis movements, these are lost if you delete a keyframe. If you attempt to delete a keyframe, a confirmation dialog box appears, asking if you want to proceed. For more information about recording axis movements, see "**Record Axis Movement**" on [page 60](#).

**To delete a keyframe:**

1. In the **Moves** panel, enable edit mode by tapping the **DELETE** button. Delete mode is enabled when the **DELETE** button is highlighted blue.
2. In the **Keyframes** area of the **Moves** panel, tap the keyframe you want to delete. The **CONFIRM DELETE** dialog box appears ([Figure 44](#)).



*Figure 47 - CONFIRM DELETE Dialog Box*

3. Tap **YES**.  
The keyframe is deleted from the move.

## Record Axis Movement

You can record manual movement of one or more linear axes (pan, tilt, zoom, focus), to override movement defined in the keyframes of a move. When you record movement for an axis, all previously-recorded movements of that axis are overwritten.

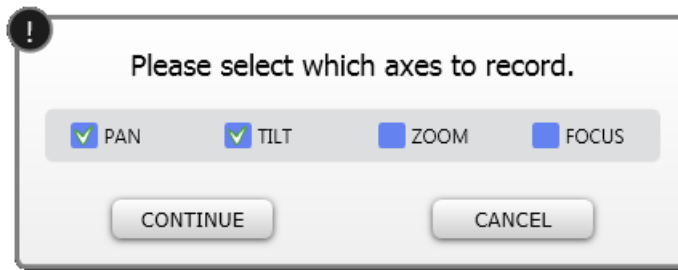
When you recall the move, for each axis you can specify whether SmartShell uses the recorded movement or the original movement as defined in the presets.

**Notes:**

- The recording of axis movement does not apply to the **Lift** and **Track** axes for Furio robots, nor does it apply to the **Lift** and **XY** (floor) axes for CamBot XY pedestals.
- All recorded axis movements are lost if you later change the duration of the move or add, edit, or delete a keyframe. If you attempt to make such a change, a confirmation dialog box appears, describing the impact of the change and asking if you want to proceed.
- You cannot record axis movement for a locked move. Icons for locked items have a lock symbol. For more information about locked items, see **“Locking Presets and Moves”** on [page 74](#).

**To record axis movements:**

1. In the **Moves** panel, tap **CUE RECORD**.
2. Tap the move for which you want to record one or more axes.
3. In the **Please select which axes to record** dialog box, select the axes you want to record. Check marks indicate axes to be recorded. In [Figure 48](#), the **PAN** and **TILT** axes are selected for recording.



**Figure 48 - Pan and Tilt Axes are Selected for Recording**

4. Tap **CONTINUE**.  
All axes move to their starting positions for the move. The move is cued.
5. After the move is cued, tap **RECORD** and then tap the move.  
The move starts and SmartShell records manual movements of the selected axes.
6. Use the joystick panel to manually control the selected axes as the move progresses.
7. When you are finished moving the selected axes, tap **STOP RECORDING**.  
The manual movements of the selected axes are recorded as part of the move.  
**Tip:** If you do not tap **STOP RECORDING**, recording stops when the move is complete.

In the keyframes, blue axis buttons indicate that movement for those axes is recorded. Green axis buttons indicate keyframe-defined movement. Red axis buttons indicate disabled axes. Before you recall the move, you can switch between recorded and preset-defined movements for each axis by double-tapping or double-clicking its axis button.

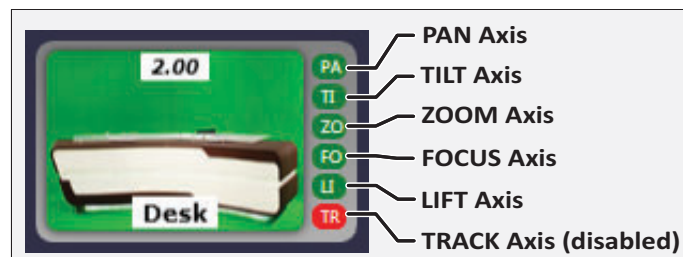
## Enabling and Disabling Preset Data for Individual Axes within a Keyframe

Within a keyframe, you can disable the keyframe's position data for one or more axes so the values are ignored for that part of the move.

When you disable the data for an axis, the axis itself is not disabled. The movement trajectory for the axis is based on data from the previous and next keyframes (assuming axis data is enabled in those keyframes).

**Note:** You cannot enable or disable preset data for a locked move. Icons for locked items have a lock symbol. For more information about locked items, see "**Locking Presets and Moves**" on [page 74](#).

[Figure 49](#) on [page 61](#) shows the axis buttons that enable or disable the data for each axis within a keyframe. Green means the axis data is enabled; red means it is disabled.



**Figure 49 - Enabling and Disabling Axes within a Keyframe**

**To enable or disable preset data for an axis:**

- In the **Keyframes** area of the **Moves** panel, tap the axis buttons to enable or disable individual axes as required.

# Clone a Move

You can duplicate a move and then edit it and/or drag it into a different move category.

**Note:** If you clone a move that has an external ID, edit the cloned move to assign an external ID as required. Certain types of automation control systems require that moves and presets have external IDs. The ability to assign external IDs is available only if your Ross Robotics system is configured to interact with a control automation system that requires them.

**To clone a move:**

1. In the **Moves** panel, tap **CLONE**.
2. Tap the move you want to duplicate.
3. The **DUPLICATE MOVE** dialog box appears.
4. In the **Name** box, type a name for the new move.  
**Note:** Depending on how the system is configured, it may not allow the name of the new move to be the same as an existing move and/or preset.
5. Tap **OK**.

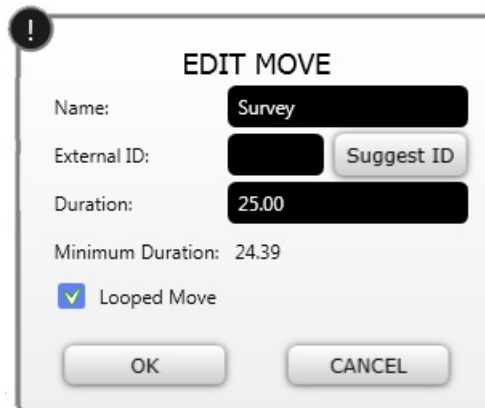
# Edit a Move

You can edit a move to rename it, change its external ID, and rescale it (change its duration). If the first and final keyframes have identical positions, you can also set the move to loop (cycle indefinitely).

**Note:** You cannot edit a locked move. Icons for locked items have a lock symbol. For more information about locked items, see "**Locking Presets and Moves**" on [page 74](#).

**To edit a move:**

1. In the **Moves** panel, enable edit mode by tapping the **EDIT** button.  
Edit mode is enabled when the **EDIT** button is highlighted blue.
2. Tap the move you want to change.  
The **EDIT MOVE** dialog box appears ([Figure 50](#)).



**Figure 50** - EDIT MOVE Dialog Box

**Note:** If the title of the dialog box is **EDIT MOVE (LOCKED)**, the move cannot be edited. You can clone the move and then edit the cloned copy.

3. If you want to rename the move, in the **Name** box, type a new name for the move.  
**Note:** Depending on how the system is configured, it may not allow the name of the new move to be the same as an existing move and/or preset.  
**Note:** When you rename a move in the **Moves** panel, it is also renamed in the Matrix, if used there.

**Note:** Depending on how the system is configured, it may not allow the new name to be the same as an existing move, and/or the same as an existing preset.

4. If the **External ID** box is visible and you want to change the external ID, do one of the following:
  - To assign a particular ID, in the **External ID** box, type the ID number.  
The number must be unique within the category, or unique overall, depending on how your system is configured. If the number is not sufficiently unique, an error message appears when you submit the request.
  - To request that SmartShell assign an ID, tap the **Suggest ID** button.  
An ID number appears in the **External ID** box.
  - To delete the external ID without specifying a new one, delete the contents of the box.  
Deleting the ID makes the move unavailable to the automation control system.

**Tip:** External IDs enable the automation control system to run moves and presets. The **External ID** box is visible only if your system is configured to interact with an automation control system that requires external IDs.
5. If you want to change the amount of time the move takes to run, in the **Duration** box, type the new duration, in seconds.

**Tip:** The minimum valid duration is shown below the **Duration** box.

**Note:** When you change the duration, the distances between keyframes change proportionally. For example, if the move has a duration of 50 seconds with four keyframes at 0, 10, 40, and 50 seconds, setting the duration to 25 would result in keyframes at 0, 5, 20, and 25 seconds.
6. If you want to make the move cycle indefinitely, select **Looped Move**.  
Looped moves require the first and final keyframe positions to be identical.  
Once the move is started, it continues cycling until you select the camera and tap **HALT**.  
Alternatively, you can tap **STOP ALL** to end the looped move, but this stops all cameras and requires you to take control of each camera before you can use it again.
7. Tap **OK**.  
If an error message appears, informing you that the **External ID** is not unique, specify a different ID and then tap **OK**.

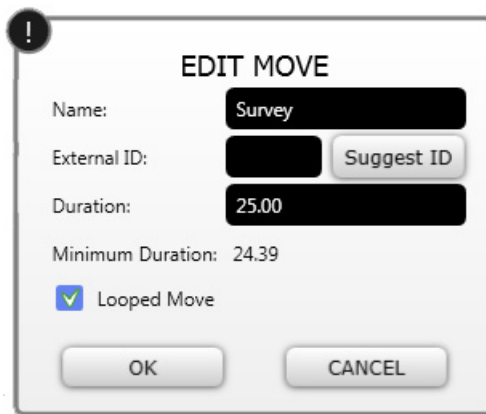
## Create a Looped Move

Once the move is started, it continues cycling until you select the camera and tap **HALT**.

Alternatively, you can tap **STOP ALL** to end the looped move, but this stops all cameras and requires you to take control of each camera before you can use it again.

### To create a looped move:

1. Create a move for which the positions of the first and final keyframes are identical (minimum three keyframes total).  
For more information, see “**Create a Move**” on [page 51](#).
2. In the **Moves** panel, enable edit mode by tapping the **EDIT** button.  
Edit mode is enabled when the **EDIT** button is highlighted blue.
3. Tap the move you want to loop.  
The **EDIT MOVE** dialog box appears ([Figure 50](#)).



**Figure 51** - EDIT MOVE Dialog Box

4. Select **Looped Move**, and then tap **OK**.

**Tip:** In the **Moves** panel, the upper right corner of the move's icon shows circling arrows to indicate that the move is a looped move.



**Figure 52** - Move Icon for a Looped Move

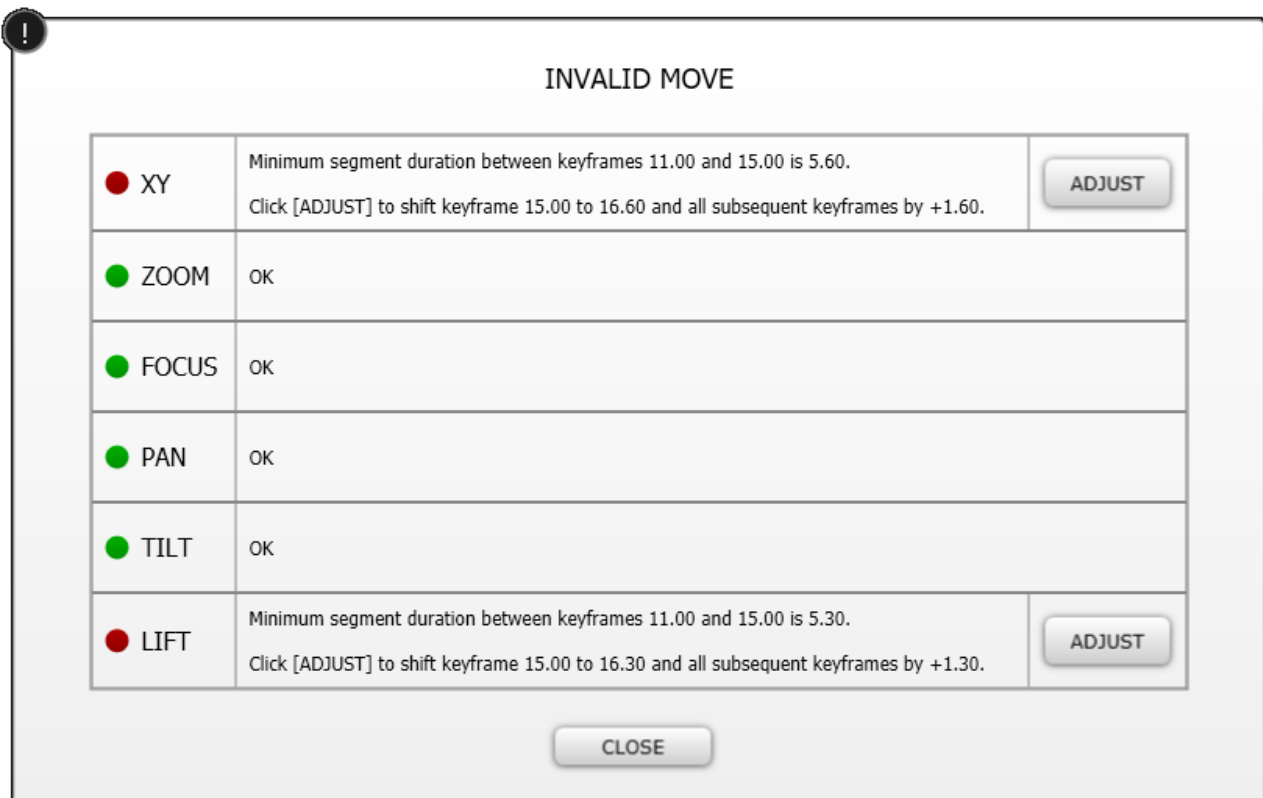
## Verify and Correct a Move

You can verify a move to ensure it is valid before you recall it. If the move is invalid, you can correct it. You can cue an invalid move, but cannot run it.

A move is invalid if one or more of the following are true:

- The allotted time between two keyframes is not long enough for the camera to move where required. If the keyframes are too close together in time (distance), satisfying the request would cause the axis to exceed system-defined velocity limits and acceleration/deceleration limits defined in the keyframe (**ACCEL/DECCEL** settings).
- The requested trajectory of a CamBot XY pedestal
  - › defines a pedestal turn radius that is too tight for the allotted time between keyframes, which would demand a velocity or acceleration in excess of the system-defined limits.
  - › exceeds the pedestal orientation limits of +/-210 degrees.
  - › causes the pan axis to go beyond its limits.

When you verify an invalid move, the **INVALID MOVE** dialog box appears and lists the problems that cause the move to be invalid and provides means of resolving them. If the problem is a lack of sufficient time between keyframes, an **ADJUST** button appears, enabling you to automatically resolve the problem.



**Figure 53** - INVALID MOVE Dialog Box

**Note:** If a move for a CamBot XY pedestal includes one or more keyframes that are beyond XY limits, the system automatically calculates an adjusted trajectory that keeps the pedestal within XY limits. If the adjusted trajectory requires a turn rate that is beyond the pedestal's capability, the move does not validate. A message appears in the **INVALID MOVE** dialog box, indicating that more time is required between keyframes. For more information about how a move is adjusted when encountering XY limits, see **"Encountering an XY (floor) Limit During Move Recall"** on [page 69](#).

**Notes:**

- You can verify a locked move, but you cannot make changes to it. If a locked move is not valid, you can clone it and then correct the cloned copy. For more information about locked items, see **"Locking Presets and Moves"** on [page 74](#).
- If the move includes recorded axis movements, these are lost if you edit a keyframe. If you attempt to edit a keyframe, a confirmation dialog box appears, asking if you want to proceed. For more information about recording axis movements, see **"Record Axis Movement"** on [page 60](#).

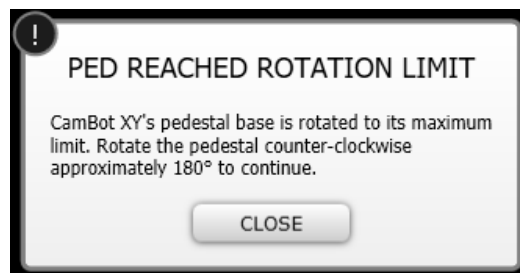
**To verify and correct a move:**

1. In the **Moves** panel, tap the **VERIFY** button.
2. Tap the move you want to verify.
3. If a **VALID MOVE** message appears, tap **OK**.  
The move is valid. Skip the remaining steps.
4. If the **INVALID MOVE** dialog box appears ([Figure 53](#)), the move is invalid.  
Each axis row that has a red dot includes a message about one or more problems that make the requested axis motion invalid. The message also describes a proposed solution to make the move valid.

5. For each axis row that has a problem, do one of the following:
  - If the problem is a lack of sufficient time between keyframes and you want to apply the proposed solution, tap the **ADJUST** button.
  - Note the message details to assist you in solving the problem manually.
6. After you have reviewed all axis rows, tap the **CLOSE** button.  
The **INVALID MOVE** dialog box closes.
7. To resolve one or more problems manually, edit the invalid keyframe(s) to do one or more of the following, depending on the contents of the **INVALID MOVE** message:
  - Increase the **Distance** value of the keyframe(s).
 

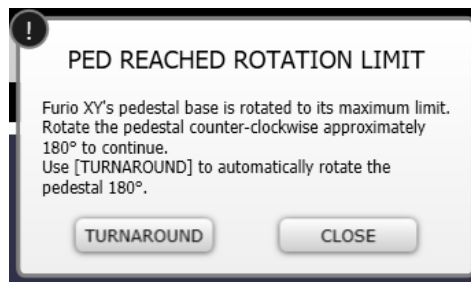
**Tip:** If you increase the distance value of a keyframe, the distances of subsequent keyframes may also need to be increased. Keyframe distance values represent the total time elapsed from the start of the move. If you increase the distance value to be higher than that of one or more subsequent keyframes, the order of the keyframes changes accordingly. To maintain the order of the keyframes, increase the distance of each of the later keyframes, starting from the final one and working towards the current one.
  - Increase the acceleration and deceleration settings (**ACCEL** and **DECEL**) of the affected axes to reduce the time required to perform the move.
  - For CamBot XY pedestals,
    - › if the turn radius is too tight, reduce the **Tension** value to make the required base rotation possible, and/or increase the **Distance** value of the keyframe.
 

**Tip:** If you increase the distance value of the keyframe, the distances of subsequent keyframes may also need to be increased. Keyframe distance values represent the total time elapsed from the start of the move. If you increase the distance value to be higher than that of one or more subsequent keyframes, the order of the keyframes changes accordingly. To maintain the order of the keyframes, increase the distance of each of the later keyframes, starting from the final one and working towards the current one.
    - › add or remove keyframes to make the XY curve more gradual.
    - › if pedestal orientation limits are exceeded, you must modify the XY trajectory (the path traveled on the floor). If there is a sharp turn in the curve near a keyframe, consider setting the keyframe's tension to **100** so that the pedestal will stop and possibly reverse direction in order to keep pedestal orientation within limits.
    - › reaching or exceeding pedestal orientation limits for CamBot XY pedestals prompt the following notification shown in [Figure 54](#).



**Figure 54** - CamBot XY Pedestal Rotation Limit Dialog

- › reaching or exceeding pedestal orientation limits for Furio pedestals prompt the following notification shown in [Figure 55](#). Using **Turnaround** enables automatic 180° pedestal rotation.



**Figure 55** - Furio XY Pedestal Rotation Limit Dialog

- › if XY limits are exceeded, do one or more of the following:
    - › adjust the **Tension** of keyframes near the edge of the XY limits to reduce the move curvature and bring it within limits.
    - › add a keyframe to further constrain XY movement close to the edge of the XY limits.
    - › reposition the offending keyframe farther away from the edge of the XY limits.
  - › if Pan axis limits are exceeded, define a new valid Pan position for the keyframe.
8. Verify the move again to ensure it is valid.

**For More Information About...**

- changing the distance, tension, acceleration rate, and deceleration rate of a keyframe, see “**Edit a Keyframe**” on [page 57](#).
- how the system processes moves, see “**Understanding Moves**” on [page 46](#).

## Cue and Run a Move

When you cue a move, the camera relocates to the starting position for the move.

Before you cue and run a move, it is important to know whether the video output from the camera you are about to move is currently on-air. If your system includes tally integration, on-air status is indicated by a red dot in the **Camera Selection** panel. The joystick button for the camera is also red.

Before you cue and run a move, we recommend you verify it to ensure the move is valid. For more information, see “**Verify and Correct a Move**” on [page 64](#).

If the camera system is a Furio Dolly, the move’s starting position along the track may not be reachable at the time of cueing. For information about how the system behaves in such cases, see “**Cueing Dolly Moves with Unreachable Track Start Position**” on [page 70](#).

**Note:** If you want to stop the selected camera at any time, tap its **STOP** button. To stop all cameras, tap **STOP ALL**.

**To cue and run a move:**

1. In the **Moves** panel, tap the **CUE** button.
2. If you want to use the alternative cue speed feature to reduce the speed of robotic motion during cueing, press and hold the **ALT** key on the computer keyboard while you perform the next step. For more information about alternative cue speed, see “**Alternative Cue/Cut Speed**” on [page 42](#).
3. Tap the move.
 

A progress bar below the **Moves** panel shows the remaining time required to cue the move.

**Note:** If the attempt to cue the move is not successful, the border of the move button turns orange.
4. Tap **RUN**, and then tap the move you want to run.
 

If the move is valid, it runs.
5. If the **INVALID MOVE** dialog box appears, the move is not valid. Do the following:

- a. For each axis row that has a red dot, review the message and then either tap **ADJUST** to accept the proposed solution, or note the message details so you can resolve the problem(s) manually.  
For more information, see “**Verify and Correct a Move**” on [page 64](#).
- b. After you have reviewed all messages, tap **CLOSE**.  
The **INVALID MOVE** dialog box closes.
- c. Verify the move.  
For more information, see “**Verify and Correct a Move**” on [page 64](#).
- d. Cue and run the move again.

**To change the speed (duration) of a move during recall:**

1. If the camera is not selected, select it.
2. On the **Legacy Joystick Panel**, turn the **TIME** knob clockwise to increase the duration, or counter-clockwise to decrease it.  
**Note:** Depending on how the system is configured, you may need to press and hold the ALT button while you turn the **TIME** knob.  
On the **CX-3R Joystick Panel**, roll the **Active Duration** roller upwards to increase the duration, and downwards to decrease it.  
The updated duration appears on the progress bar at the bottom of the main SmartShell window. You can prolong the move up to ten times its original duration, or shorten it to as little as half its original duration.  
The degree to which you can shorten the duration may be limited by the physical capabilities of the system. Robotic axes always remain within defined limits for acceleration rate, speed, and deceleration rate.  
When you use the **TIME** knob to change the overall duration of a move, the effect is distributed across all keyframes of the move proportionately.  
The effect on the duration is distributed proportionately across all keyframes of the move. For example, if you double the move duration, all subsequent keyframe positions are reached later than originally specified, and the distance (time) between each keyframe and the next is doubled. The position of the robotic axes at each keyframe are not affected, but the time it takes to reach each keyframe is.  
**Note:** This feature does not apply to looped moves.

**To manually control a camera during move recall:**

1. If the camera is not selected, select it.
2. Use the joystick panel to manually control one or more axes as required.  
For more information about using the joystick panel, see “**Joystick Panel Controls**” on [page 91](#).  
**Note:** Manual movements are applied cumulatively, as offsets, to each subsequent keyframe position in the move. For example, if the lift column of a Furio dolly would normally extend 30 cm (12 inches) between the first and second keyframes, but you manually extend it an extra 15 cm (6 inches) as soon as the move starts, then the column continues to extend from that point. When the second keyframe is reached, the column will have extended a total of 45 cm (18 inches) unless it reaches its axis limit earlier. When the robot reaches the next keyframe in the move, the lift is 15 cm (6 inches) higher than what was originally defined in the keyframe, and so on. Robotic axes always remain within defined axis limits.  
**Note:** This feature does not apply to looped moves.

## Delete a Move

**Note:** You cannot delete a locked move. Icons for locked items have a lock symbol. For more information about locked items, see “**Locking Presets and Moves**” on [page 74](#).

**To delete a move:**

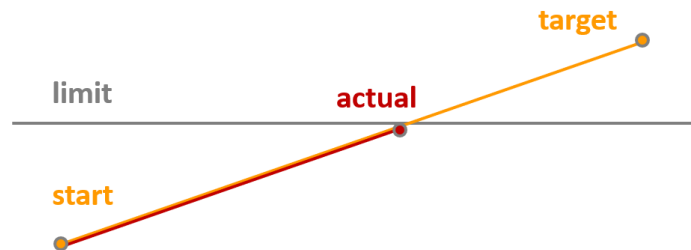
1. In the **Moves** panel, tap the **DELETE** button, and then tap the move you want to delete.
2. In the **CONFIRM DELETE** dialog box, tap **YES**.

## Encountering an XY (floor) Limit During Move Recall

If a move for a CamBot XY pedestal specifies an XY (floor) destination that is beyond the XY limits of the pedestal, the move can be recalled but the XY trajectory is aborted when the XY axis reaches a limit.

As the XY pedestal approaches an X-axis limit or Y-axis limit, it slows down and stops at the limit.

[Figure 56](#) illustrates the behavior of an XY pedestal as it encounters an XY limit while recalling a move.



**Figure 56** - XY Pedestal Behavior when Encountering an XY (floor) Limit while Recalling a Move

# Cueing Dolly Moves with Unreachable Track Start Position

When you cue a move for a Furio Dolly, the dolly attempts to move all controllable axes to their starting positions, as specified in the first keyframe of the move.

The dolly may be unable to reach the starting track position during cueing, for one of the following reasons:

- The starting track position is beyond the dolly's track limit.  
This can occur if the dolly's track limits have changed since the move was created.
- The starting track position is beyond a collision avoidance limit, meaning that another dolly is blocking access to the starting track position.

After you tap the **CUE** button, the dolly moves along the track, and then one of the following occurs:

- If the dolly successfully reaches the starting track position, the move is cued and the border of the move icon turns green to indicate that the move is ready to be run.
- If the dolly does not reach the starting track position, the robot analyzes the move to determine whether it can be run successfully from the dolly's current track position. To run the move successfully, the dolly must be able to travel from its current track position to the next required track position within the time allotted by the move definition. For example, if the move specifies that the time between the first and second keyframes is 12 seconds, the dolly must be capable of reaching the track position specified in the second keyframe within 12 seconds.

The move analysis results in one of the following:

- › If the move can be run, the border of the move icon turns orange to indicate that the move is cued, but that the dolly is not at the track position specified in the first keyframe. The move is available to be run.

**Note:** Before you run the move, clear all other dollies away from the move path. If the dolly encounters a collision avoidance limit, the move will fail.

- › If the move cannot be run, the cueing operation fails. The border of the move icon turns gray.

**Tip:** If possible, move the blocking dolly out of the way and then try to cue the move again.

# Locking Presets and Moves

Depending on how your system is configured, you may be allowed to lock and unlock presets and moves.

Locking presets and moves helps to prevent inadvertent changes. Icons for locked presets and moves have a lock symbol.



*Figure 58 - Icon for a Locked Preset, showing Lock Symbol (top left)*

When locking and unlocking capabilities are available, the **Presets** panel and the **Moves** panel each contain an **(UN)LOCK** button.

If these buttons are not visible, you do not have permission to lock and unlock presets and moves. For more information, contact your system administrator.

## To lock or unlock a preset or move:

1. Do one of the following:
  - If you want to lock or unlock a preset, in the **Presets** panel, tap the **(UN)LOCK** button.
  - If you want to lock or unlock a move, in the **Moves** panel, tap the **(UN)LOCK** button.Lock/unlock mode is enabled when the **(UN)LOCK** button is highlighted blue.
2. Tap the preset or move to change the lock status of the item.

## To lock or unlock all items in a category:

1. Touch and hold a category tab until a circle appears, and then release it.  
**Tip:** If you are using a mouse, right-click any category tab.
2. On the category menu, tap one of the following:
  - **Lock all items in this category**
  - **Unlock all items in this category**All items in the category are locked or unlocked, in both the **Presets** panel and the **Moves** panel.

# The Matrix View

The **Matrix view**, or **Matrix** (Figure 58) consists of customizable buttons that enable you to efficiently operate multiple cameras.

Each Matrix button represents a predefined action such as cutting to a preset, cueing/running a move, or running a macro (group of presets). In the Matrix, you can create, store, and perform hundreds of actions.

You can also save and load Matrix files.



Figure 58 - The Matrix View

This section includes the following topics:

- “Access the Matrix View” on [page 73](#)
- “Using Matrix Buttons” on [page 73](#)
- “Assign an Action to a Matrix Button” on [page 74](#)
- “Creating and Editing Macros” on [page 75](#)
- “Create a New Preset Action on a Matrix Button” on [page 79](#)
- “Edit a Matrix Button (Preset or Move)” on [page 82](#)
- “Reposition Matrix Buttons” on [page 85](#)
- “Deleting a Matrix Button” on [page 85](#)
- “Create a New Page of Matrix Buttons” on [page 85](#)
- “Navigate Between Pages of Matrix Buttons” on [page 85](#)
- “Select a Camera for Joystick Control” on [page 86](#)
- “Create a New Matrix” on [page 86](#)
- “Save a Matrix File” on [page 86](#)
- “Load a Matrix File” on [page 86](#)

# Access the Matrix View

## To access the Matrix view:

- From the main SmartShell interface, tap the **Matrix View** button ([Figure 59](#)). SmartShell shows the most recently-used Matrix. You can also load a different Matrix, or create a new one.



**Figure 59** - Matrix View Button

## To return to the main SmartShell interface:

- In the bottom right corner of the screen, tap the **Camera View** button.



**Figure 60** - Camera View Button

# Using Matrix Buttons

Before you use a Matrix button to perform an action, it is important to know whether the video output from the camera you are about to move is currently on-air. When a camera is on-air, Matrix buttons for it have red outlines. On-air status is also indicated by a red dot in the **Camera Selection** panel, above the Matrix. The joystick button for the camera is also red.

**Note:** Some systems do not include tally integration, and therefore do not indicate which camera is on-air.

Before you begin, ensure that no modes are active. If one of the mode buttons in the lower right corner of the **Matrix view** is blue, tap the button to exit its mode. This applies to the **ADD & ASSIGN** button, the **ASSIGN** button, the **ADD MACRO** button, the **UPDATE** button, and the **EDIT** button.

## To perform an action in the Matrix:

1. In the **Matrix view**, if one of the buttons in the lower right corner is blue, tap the button to exit its mode.  
This applies to the **ADD & ASSIGN** button, the **ASSIGN** button, the **ADD MACRO** button, the **UPDATE** button, and the **EDIT** button.
2. If the action you want to perform includes cueing a camera or cutting to a preset and you want to use the alternative cue/cut speed feature to reduce the speed of robotic motion, press and hold the **ALT** key on the computer keyboard while you perform the next step.  
For more information about alternative cue speed, see [“Alternative Cue/Cut Speed”](#) on [page 42](#).
3. Tap the action (Matrix button) you want to perform:
  - If the Matrix button is a **CUT PRESET** button, **RUN PRESET** button, or **RUN MACRO** button, SmartShell performs the action immediately.
  - If the Matrix button is a **CUE MOVE** or **CUE PRESET** button, SmartShell cues the action the first time you tap the button.

**Note:** The **CUE PRESET** and **CUE MOVE** options do not apply to Vinten robots. If such a Matrix button exists for a Vinten robot, it is not operational.

After the action is cued, the border around the Matrix button turns green and the button says RUN. The action is ready to run. Tap the Matrix button again to run the move or preset.

**Note:** If the Matrix button is a **CUE MOVE** or **CUE PRESET** button and cueing is not successful, the border of the Matrix button is orange.

**Note:** When **CUE** finishes and **MOVE** is valid, the **RUN** button is enabled.

**Note:** Some systems are configured to prevent on-air **CUE** and **CUT** operations.

**Note:** Depending on the configuration and third-party interactions (such as OverDrive), a cued move can be uncued by moving an axis with a joystick to prevent unintended motion when a move run is no longer desired.

4. On the **CX-3R Joystick Panel**, roll the **Active Duration** roller upwards to increase the duration, and downwards to decrease it.

- On the **Legacy Joystick Panel**, turn the **TIME** knob clockwise to increase the duration or counter-clockwise to decrease it.

**Note:** Depending on how the system is configured, you may need to press and hold the **ALT** button while you turn the **TIME** knob.

- On the **CX-3R Joystick Panel**, roll the **Active Duration** roller upwards to increase the duration, and downwards to decrease it.

The new duration appears on the Matrix button.

For more information about the effects of using the **TIME** knob to change the duration:

- If the Matrix button is a **RUN PRESET** button or **RUN MACRO** button, see “**To change the speed (duration) of a preset during recall:**” on [page 41](#).
- If the Matrix button is a **RUN MOVE** button, see “**To change the speed (duration) of a move during recall:**” on [page 68](#).

5. If you want to manually control the camera during recall, use the joystick panel controls.

For more information about using the joystick panel, see “**Joystick Panel Controls**” on [page 91](#).

For more information about the effects of manually controlling a camera during recall:

- If the Matrix button is a **RUN PRESET** button or **RUN MACRO** button, see “**To manually control a camera during preset recall:**” on [page 42](#).
- If the Matrix button is a **RUN MOVE** button, see “**To manually control a camera during move recall:**” on [page 68](#).

## Assign an Action to a Matrix Button

You can assign an action to a Matrix button. An action is a task that SmartShell performs when you tap the button. Actions include **CUT TO PRESET**, **CUE/RUN PRESET**, and **CUE/RUN MOVE**.

**Tip:** Alternatively, you can create a new preset that is automatically assigned to a Matrix button. For more information, see “**Create a New Preset Action on a Matrix Button**” on [page 79](#).

**Note:** Macros are created differently. For more information, see “**Creating and Editing Macros**” on [page 75](#).

**To assign an action to a Matrix button:**

1. In the **Matrix view**, tap the **ASSIGN** button to enter ASSIGN mode.

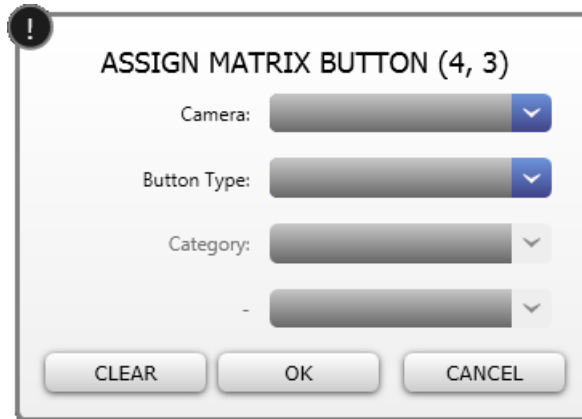
**Tip:** The Matrix is in ASSIGN mode when the **ASSIGN** button is highlighted blue.

2. Tap the Matrix button to which you want to assign an action.

**Tip:** Gray buttons labeled **ASSIGN** are blank and available for new actions. Other buttons are previously-defined actions you can modify.

**Tip:** To create another page of buttons within the same Matrix, tap the **NEXT** button until the page number doesn't increase. The current page is a new page.

The **ASSIGN MATRIX BUTTON** dialog box appears ([Figure 61](#)).



**Figure 61** - ASSIGN MATRIX BUTTON Dialog Box

3. In the **Camera** list, tap the camera you want use.
4. In the **Button Type** list, tap the type of action you want the camera to perform when tapped by an operator:
  - **CUT TO PRESET** — When tapped, the camera cuts to the preset position as quickly as possible.  
**Note:** A green border for the Matrix button indicates the preset can go on-air. An orange border is the default style until an assigned preset can go on-air.
  - **CUE/RUN PRESET** — For Furio robots and most CamBot robots, when tapped, the camera moves to the preset position in the time specified.  
For CamBot XY pedestals, when tapped the first time the robot's base rotates to align its wheels with the preset position, so it is cued. When tapped a second time, the CamBot XY pedestal runs the preset in the time specified.  
**Note:** The **CUE/RUN PRESET** option does not apply to Vinten robots. If you create a **CUE/RUN PRESET** button for a Vinten robot, the button will not work.
  - **CUE/RUN MOVE** — When tapped the first time, the camera cues the move by moving to the starting position. When tapped a second time, the camera runs the move.
5. In the **Category** list tap the category that contains the move or preset.
6. In the **Move** or **Preset** list, tap the more or preset you want use.
7. If you selected the **CUE/RUN PRESET** action in **4** on **page 75** and want to specify a different duration, type the duration value in the **Alternative Duration** box.
8. Tap **OK**.
9. If you want to assign actions to other Matrix buttons, repeat **2** to **8**.
10. When you have finished assigning actions, tap the **ASSIGN** button to exit ASSIGN mode.

## Creating and Editing Macros

A macro is a group of presets represented by a macro button in the Matrix. When a macro runs, all of its presets run. Macros enable you to efficiently put multiple cameras into motion at the same time. Each preset within a macro is for a separate camera.

This section describes how to create and edit macros. It contains the following topics:

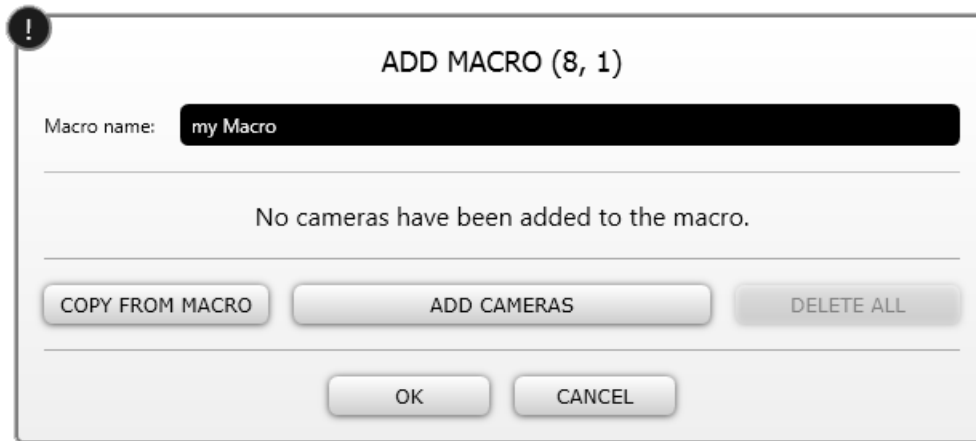
- “**Create a New Macro**” on [page 76](#)
- “**Add a Preset to a Macro by Dragging**” on [page 78](#)
- “**Edit a Macro**” on [page 78](#)

## Create a New Macro

When you create a macro, you specify which cameras are included and which preset each camera runs whenever the macro is triggered.

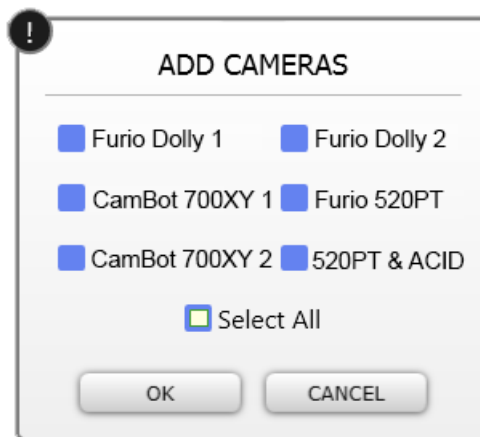
### To create a new macro:

1. Create the presets you want to include in the new macro.  
For more information, see “[Add a Preset](#)” on [page 29](#).
2. In the **Matrix view**, tap the **ADD MACRO** button to enter **ADD MACRO** mode.  
**Tip:** The Matrix is in **ADD MACRO** mode when the **ADD MACRO** button is highlighted blue.
3. Tap the Matrix button to which you want to assign the new macro.  
**Note:** If the button you tap has already been assigned, the new macro replaces the previous assignment.  
The **ADD MACRO** dialog box appears ([Figure 62](#)).



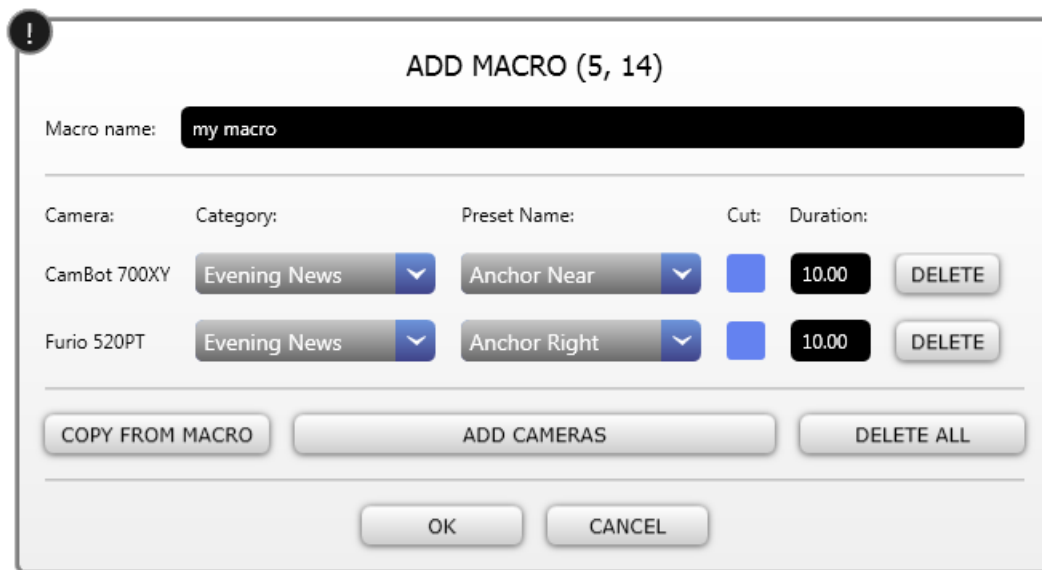
**Figure 62** - ADD MACRO Dialog Box

4. In the **Macro name** box, type a name for the new macro.
5. If you want to base the new macro on settings copied from an existing macro:
  - a. Tap the **COPY FROM MACRO** button.  
The **COPY FROM MACRO** dialog box appears.
  - b. In the **COPY FROM MACRO** dialog box, select the macro from which you want copy settings.
  - c. Tap **OK**.  
The **ADD MACRO** dialog box reappears, showing settings copied from the other macro.
6. Specify which cameras you want to include in the macro:
  - a. Tap the **ADD CAMERAS** button.  
The **ADD CAMERAS** dialog box appears ([Figure 63](#)).



**Figure 63** - ADD CAMERAS Dialog Box

- b. In the **ADD CAMERAS** dialog box, select all the cameras you want to include.
  - Tip:** Check marks indicate the selected cameras. Tap camera names to select/deselect them.
- c. Tap **OK**.  
The **ADD MACRO** dialog box reappears ([Figure 64](#)), and includes a row for each camera you selected.



**Figure 64** - ADD MACRO Dialog Box, Listing Cameras Included in Macro

7. For each camera in the macro, specify the following:
  - **Category** — The category that contains the preset you want the macro to run.
  - **Preset Name** — The preset you want the macro to run.
  - **Cut** — Select the **Cut** check box if you want the camera to move to the preset position as quickly as possible. Cut overrides the duration value.
  - **Duration** — Specify a default duration (in seconds).  
When the macro runs, each preset runs for its specified duration, so the macro takes as long as the longest duration value. Presets with short durations finish moving before others.  
If the specified duration for a given preset is too short for the preset to run, it cuts as quickly as possible (no warning message).
8. If you want to remove a camera from the macro, tap the **DELETE** button for that camera.
9. When you are finished specifying cameras and presets, tap **OK**.

A new macro button appears in the Matrix. Macro buttons have pink borders. Across the top of the button icon is the number of cameras used in the macro. Across the bottom is the name of the macro. The body of the icon has up to four thumbnail images.

## Add a Preset to a Macro by Dragging

If one or more Matrix buttons already have presets assigned to them, you can easily drag any or all of those presets into existing macros. When you drag presets into macros the preset Matrix buttons remain.

Before you begin, ensure that no modes are active. If one of the mode buttons in the lower right corner of the **Matrix view** is blue, tap the button to exit its mode. This applies to the **ADD & ASSIGN** button, the **ASSIGN** button, the **ADD MACRO** button, the **UPDATE** button, and the **EDIT** button.

### To add a preset from a Matrix button to an existing macro:

- Tap and hold the Matrix button that contains the preset you want to add, drag it over the macro button, and then release.

The preset is added to the macro.

If the macro already contained a preset that uses the same camera as the preset you dragged in, the original preset is replaced by the one you dragged in.

## Edit a Macro

When you edit a macro you can rename it, specify different cameras and presets, and change preset durations.

### To edit a macro:

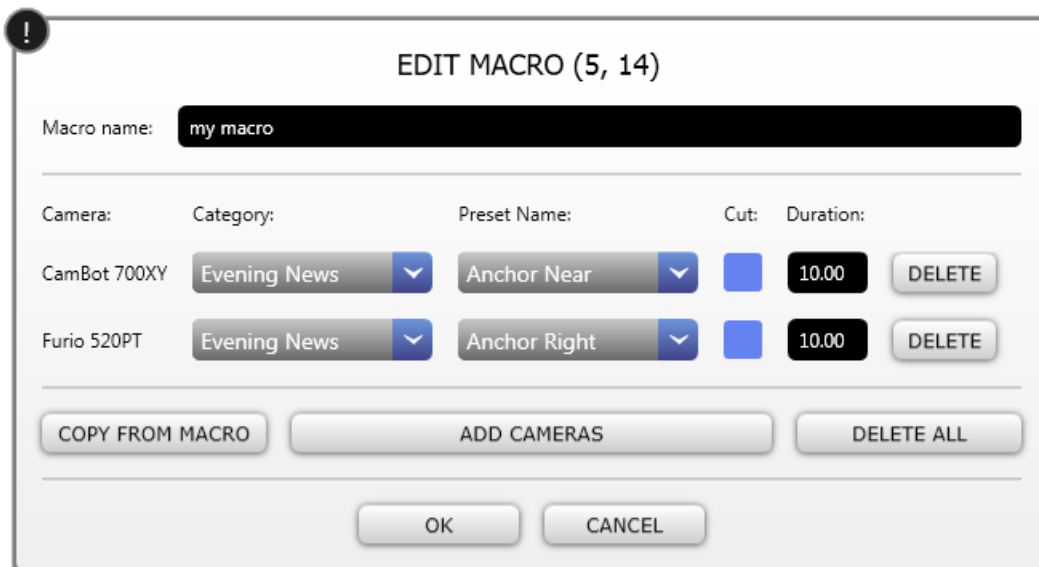
1. In the **Matrix view**, navigate to the page that shows the button for the macro you want to edit.
2. Tap the **EDIT** button to enter **EDIT** mode.

**Tip:** The Matrix is in **EDIT** mode when the **EDIT** button is highlighted blue.

3. Tap the Matrix button for the macro you want to edit.

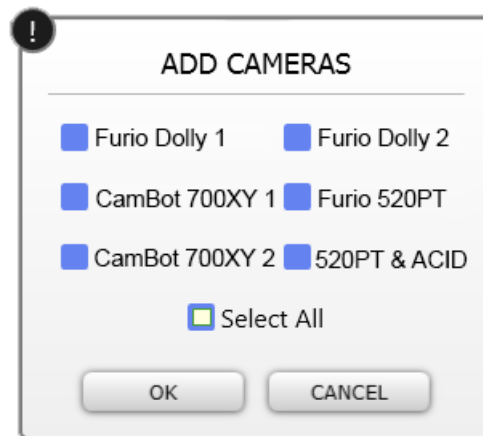
The **EDIT MACRO** dialog box appears ([Figure 62](#)) and includes a row for each camera / preset in the macro.

**Note:** If one or more of the cameras in the macro is not currently operational, the list shows it as unavailable (gray).



**Figure 65** - ADD MACRO Dialog Box

4. If you want to rename the macro, in the **Macro** name box, type a new name for the macro.
5. If you want to replace all presets with those from a different macro:
  - a. Tap the **COPY FROM MACRO** button.  
The **COPY FROM MACRO** dialog box appears.
  - b. In the **COPY FROM MACRO** dialog box, select the macro from which you want copy settings.
  - c. Tap **OK**.  
The **EDIT MACRO** dialog box reappears, showing settings copied from the other macro.
6. Specify which cameras you want to include in the macro:
  - a. Tap the **ADD CAMERAS** button.  
The **ADD CAMERAS** dialog box appears ([Figure 66](#)).



**Figure 66** - ADD CAMERAS Dialog Box

- b. In the **ADD CAMERAS** dialog box, select all the cameras you want to include. Deselect cameras you don't want to use.  
**Tip:** Check marks indicate the selected cameras. Tap camera names to select/deselect them.
  - c. Tap **OK**.
7. For each camera in the macro, specify the following:
  - **Category** — The preset category that contains the preset you want the macro to run.
  - **Preset Name** — The preset you want the macro to run.
  - **Cut** — Select the **Cut** check box if you want the camera to move to the preset position as quickly as possible.
  - **Duration** — Specify a duration (in seconds).  
When the macro runs, each preset runs for its specified duration so the macro takes as long as the longest duration value. Presets with short durations finish moving before others.  
If the specified duration for a given preset is too short for the preset to run, it cuts as quickly as possible (no warning message).
8. If you want to remove a camera from the macro, tap the **DELETE** button for the camera.
9. When you are finished specifying cameras and presets, tap **OK**.

## Create a New Preset Action on a Matrix Button

You can use the **ADD & ASSIGN** button to create a new preset action assigned to a Matrix button.

The new preset appears in a preset category, and can be used in moves (Furio robots and CamBot XY pedestals only).

**Tip:** This feature is useful for quickly creating a Matrix of preset action buttons. Create an empty preset category, and then use this feature to set up your presets and populate the new category.

**Tip:** This feature is also useful for making quick temporary changes to preset action buttons in the Matrix. For example, if your regular show has a one-time guest host who is significantly taller than your regular host, you can quickly reassign preset action buttons to touch up the preset positions. Do one of the following:

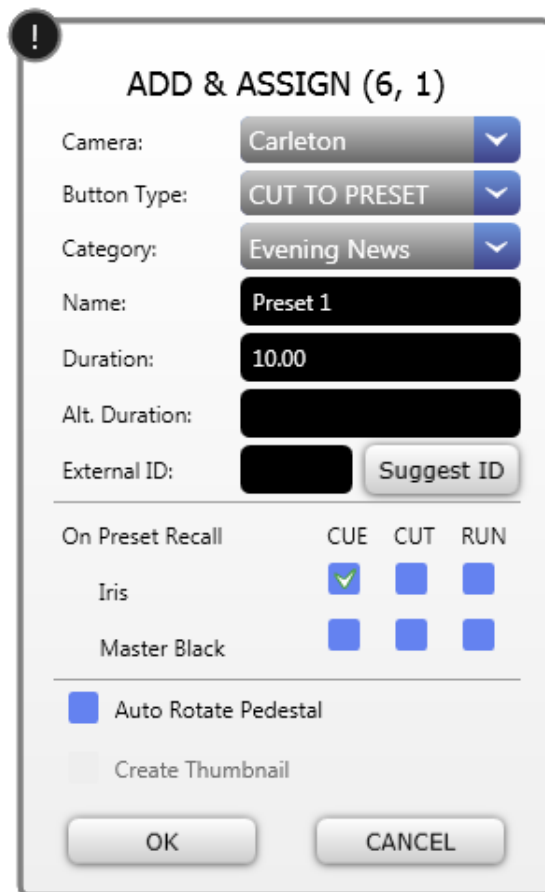
- **New Category** — Create an empty preset category to contain the new presets. For each preset action button you want to temporarily adjust, run the preset action, adjust the camera position, and then use the **ADD & ASSIGN** button to create a new preset action button over the old one. After the show, if you want to keep the changes, save them in a Matrix file using a new Matrix file name. If you want to revert to the original Matrix, reload the original Matrix file.
- **Temporary Category** — For each preset action button, run the preset action, adjust the camera position, and then use the **ADD & ASSIGN** button to create a new preset action button over the old one, saving the presets to the temporary category. After the show, close SmartShell, opting to delete the temporary category and close without saving changes to the Matrix file (**DELETE AND CLOSE**). Your changes are not saved, and the system is ready for the next user.

For more information, see “**The Temporary Category**” on [page 28](#).

**Note:** This feature can create presets for all CamBot and Furio robots, but does not create moves.

**To create a new preset on a Matrix button:**

1. Manually position the camera exactly where you want it to be for the preset, in all controllable axes.  
**Tip:** You can manually position the camera in SmartShell, or using the joystick panel.
2. In the **Matrix view**, tap the **ADD & ASSIGN** button to enter **ADD & ASSIGN** mode.  
**Tip:** The Matrix is in **ADD & ASSIGN** mode when the **ADD & ASSIGN** button is highlighted blue.
3. Tap the Matrix button to which you want to assign a new preset action.  
**Note:** If the button you tap has already been assigned, the new preset action replaces the previous assignment.  
The **ADD & ASSIGN** dialog box appears ([Figure 67](#)).



**Figure 67** - ADD & ASSIGN Dialog Box

4. In the **Camera** list, select the camera for the preset.
5. In the **Button Type** list, tap the type of action you want the camera to perform when tapped by an operator:
  - **CUT TO PRESET** — When tapped, the camera cuts to the preset position as quickly as possible.
  - **CUE/RUN PRESET** — For Furio robots and most CamBot robots, when tapped, the camera moves to the preset position in the time specified.  
 For CamBot XY pedestals, when tapped the first time the robot's base rotates to align its wheels with the preset position, so it is cued. When tapped a second time, the CamBot XY pedestal runs the preset in the time specified.  
**Note:** The **CUE/RUN PRESET** option does not apply to Vinten robots. If you create a **CUE/RUN PRESET** button for a Vinten robot, the button will not work.
6. In the **Category** list, select the preset category where you want the preset to appear.  
**Tip:** If your system is configured to include a temporary category, the temporary category is selected by default.
7. In the **Name** box, type a name for the new preset.
8. In the **Duration** box, type the default duration of the preset recall, in seconds.  
**Tip:** Alternatively, you can use the joystick panel to adjust the duration instead of typing.
  - On the **Legacy Joystick Panel**, use the **TIME** knob to set the duration. Depending on how the system is configured, you may need to press and hold the **ALT** button while you turn the TIME knob.
  - On the **CX-3R Joystick Panel** use the **Duration** knob to set the duration.
9. If you want the preset duration on the Matrix button to be different than the default duration, in the **Alt. Duration** box, type an alternative duration, in seconds.

10. If the **External ID** box is visible and you want to make the preset available to the automation control system, do one of the following:
  - To assign a particular ID, in the **External ID** box, type the ID number.  
The number must be unique within the category, or unique overall, depending on how your system is configured. If the number is not sufficiently unique, an error message appears when you submit the request.
  - To request that SmartShell assign an ID, tap the **Suggest ID** button.  
An ID number appears in the **External ID** box.

**Tip:** External IDs enable the automation control system to run moves and presets. The **External ID** box is visible only if your system is configured to interact with an automation control system that requires external IDs.
11. In the **On Preset Recall** area, specify whether you want each of the listed camera settings to be recalled at the start of **CUE**, **CUT**, and **RUN** operations.
 

**Note:** The **On Preset Recall** area is present only if the camera is configured for recall of paint settings.

Whenever you add a preset, all listed camera settings are saved. The **On Preset Recall** settings enable you to specify when saved camera settings are to be applied. Because the camera settings are always saved, you can edit the preset to adjust the **On Preset Recall** settings anytime.
12. If the camera is a CamBot XY pedestal, and you want the system to recall the current rotational position of the base as part of the preset, select the **Auto Rotate Pedestal** check box.  
This option rotates the pedestal base at the end of the preset recall, moving the wheels to the position they were in when the preset was saved.
 

**Tip:** Use the **Auto Rotate Pedestal** option when the pedestal's next destination is known, such as for a pair of presets designed for side-to-side trucking motion. The **Auto Rotate Pedestal** option is also useful when creating a preset for the CamBot target position, because the base must be properly aligned with the target. Avoid using this option for all your presets, as it may result in unnecessary base rotation. Instead, after a preset runs, cue the next preset to rotate the base.

For more information about pedestal base rotation and presets, see "**About CamBot XY Pedestals: Base Rotation, Panning, and Presets**" on [page 43](#).
13. If you want the preset icon to show a thumbnail view from the camera's position, select the **Create Thumbnail** check box.
 

**Note:** This option is available only if your Ross Robotics system is configured to include thumbnails.
14. Tap **OK** to create the preset.  
If an error message appears, informing you that the **External ID** is not unique, specify a different ID and then tap **OK**.  
The new preset is created, and appears on the Matrix button and in the **Presets** panel of the specified category.

## Edit a Matrix Button (Preset or Move)

You can edit some properties of presets and moves assigned to Matrix buttons.

**To edit a Matrix button:**

1. In the **Matrix view**, navigate to the page that shows the button you want to edit.
2. Tap the **EDIT** button to enter **EDIT** mode.
 

**Tip:** The Matrix is in **EDIT** mode when the **EDIT** button is highlighted blue.
3. Tap the Matrix button you want to edit.  
The **EDIT MOVE** dialog box or the **EDIT PRESET** dialog box appears.
 

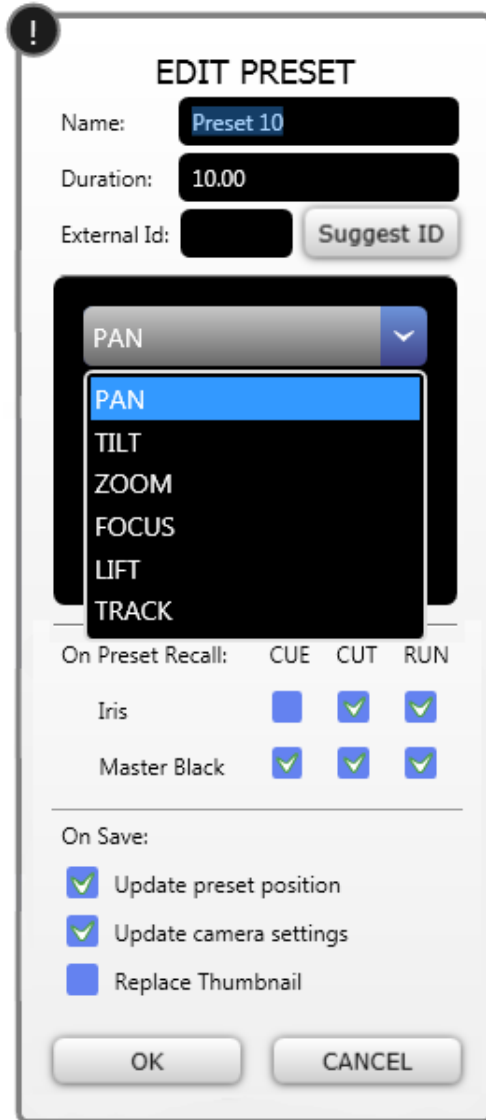
**Note:** If the top of the dialog box says **(LOCKED)**, the move or preset is locked and cannot be edited. Tap **CANCEL**, and then skip the remaining steps. For more information about locked items, see "**Locking Presets and Moves**" on [page 74](#).

In the **Name** box, type a new name for the move or preset.

4. If the action is a preset and you want to change the amount of time it takes for the preset to run, type a duration value, in seconds, in the **Duration** box.
5. If the **External ID** box is visible and you want to change the external ID, do one of the following:
  - To assign a particular ID, in the **External ID** box, type the ID number.  
The number must be unique within the category, or unique overall, depending on how your system is configured. If the number is not sufficiently unique, an error message appears when you submit the request.
  - To request that SmartShell assign an ID, tap the **Suggest ID** button.  
An ID number appears in the **External ID** box.
  - To delete the external ID without specifying a new one, delete the contents of the box.  
Deleting the ID makes the preset unavailable to the automation control system.

**Tip:** External IDs enable the automation control system to run moves and presets. The **External ID** box is visible only if your system is configured to interact with an automation control system that requires external IDs.
6. If you are editing a move, no other settings can be edited from the Matrix. Tap **OK**.  
If an error message appears, informing you that the **External ID** is not unique, specify a different ID and then tap **OK**.  
Skip the remaining steps.
7. In the **On Preset Recall** area, specify whether you want each of the listed camera settings to be recalled at the start of **CUE**, **CUT**, and **RUN** operations.  
**Note:** The **On Preset Recall** area is present only if the camera is configured for recall of paint settings.  
**Note:** Options in the **On Preset Recall** area do not cause current camera settings to be saved. They only enable you to specify when saved camera settings are to be applied. 11 on **page 84** describes how to update the saved camera settings.
8. If the camera is a CamBot XY pedestal and you want the system to recall the current rotational position of the base as part of the preset, select the **Auto Rotate Pedestal** check box.  
This option rotates the pedestal base at the end of the preset recall, aligning the wheels to a known position.  
**Tip:** Use the **Auto Rotate Pedestal** option when the pedestal's next destination is known, such as for a pair of presets designed for side-to-side trucking motion. The **Auto Rotate Pedestal** option is also useful when creating a preset for the CamBot target position, because the base must be properly aligned with the target. Avoid using this option for all your presets, as it may result in unnecessary base rotation. Instead, after a preset runs, cue the next preset to rotate the base.  
For more information about pedestal base rotation and presets, see "**About CamBot XY Pedestals: Base Rotation, Panning, and Presets**" on [page 43](#).
9. If the camera is a Furio and you want to change the acceleration or deceleration rates for an axis:

- a. In the axis list, tap the name of the axis ([Figure 68](#)).



**Figure 68** - EDIT PRESET Dialog Box with Axis List Expanded

- b. To set the acceleration rate, drag the **ACCEL** slider.  
Drag the **ACCEL** slider towards soft for slower acceleration, or towards hard for faster acceleration.
- c. To set the deceleration rate, drag the **DECCEL** slider.  
Drag the **DECCEL** slider towards **soft** for slower deceleration, or towards **hard** for faster deceleration.
10. If you want to change the position defined for the preset, manually position the camera exactly where you want it to be for the preset, in all controllable axes, and then select the **Update preset position** check box.  
**Tip:** Use the **Axis Control** panel or the joystick panel to manually position the camera.
11. If you want to update the saved camera settings (such as **Iris** position, **Master Black** level, etc), in the **On Save** area select **Update Camera Settings**.  
**Note:** The **Update Camera Settings** option is present only if the camera is configured for recall of paint settings.

12. If you want to replace the thumbnail image with a current view from the camera, select the **Replace Thumbnail** check box.  
**Note:** This option is available only if your Ross Robotics system is configured to include thumbnails.
13. Tap **OK** to apply the changes, or **Cancel** to abandon them.  
If an error message appears, informing you that the **External ID** is not unique, specify a different ID and then tap **OK**.

## Reposition Matrix Buttons

You can rearrange Matrix buttons within a Matrix page. When you move a Matrix button, it switches positions with the destination button.

### To reposition Matrix buttons:

1. Tap and hold the Matrix button you want to reposition.  
**IMPORTANT:** If you want to exchange the positions of a macro button and a button that has a preset, tap and hold the macro button. Otherwise, if you drag the button that has the preset onto the macro button, the preset is added to the macro.
2. Drag the Matrix button to its new position and then release it.  
The two buttons switch positions.

## Deleting a Matrix Button

When you delete a Matrix button, the button assignment is deleted and the button is ready for a new assignment.

### To delete a Matrix button:

1. In the **Matrix view**, tap the **DELETE** button to enter DELETE mode.  
**Tip:** The Matrix is in DELETE mode when the **DELETE** button is highlighted blue.
2. Tap the Matrix button you want to delete.  
The button assignment is deleted, and the button is ready for a new assignment.

## Create a New Page of Matrix Buttons

A Matrix can consist of multiple pages of buttons, allowing quick access to hundreds of actions.

### To create a new page of buttons:

1. In the **Matrix view**, tap the **ASSIGN** button to enter ASSIGN mode.  
**Tip:** The Matrix is in ASSIGN mode when the **ASSIGN** button is highlighted blue.
2. Tap **NEXT** repeatedly until the page number does not increase.  
The current page is a new page.

## Navigate Between Pages of Matrix Buttons

### To navigate between pages of Matrix buttons:

- Tap the **NEXT** and **PREV** buttons.

# Select a Camera for Joystick Control

When you tap a Matrix button, the associated camera becomes the selected camera for joystick control.

**Note:** This option does not apply to macro buttons, because macros affect multiple cameras.

Alternatively, you can select a camera by tapping its numbered camera selection button on the joystick panel, or by tapping a camera button in SmartShell.

Alternatively, you can select a camera by tapping its camera selection button on the joystick panel, or by tapping a camera button in SmartShell.

## Create a New Matrix

**To create a new Matrix:**

1. In the **Matrix view**, tap **New**.
2. If the **CLEAR MATRIX** dialog box appears, do one of the following:
  - Tap **YES** if you want to discard unsaved changes and create a new Matrix.
  - Tap **NO** if you want to save changes to the current Matrix. Save the current Matrix before creating a new one.
3. Assign actions to one or more blank Matrix buttons.  
When the new Matrix appears, it is in ASSIGN mode and all Matrix buttons are blank. Gray buttons labeled **ASSIGN** indicate blank Matrix buttons.

## Save a Matrix File

**To save a Matrix file:**

1. In the **Matrix view**, tap **SAVE**.  
The **Save As** dialog box appears.
2. Do one of the following:
  - To save the Matrix without changing the file name, tap **Save**.  
When prompted about replacing the existing file, tap **Yes**.
  - To save the Matrix with a new name, type the name and then tap **Save**.
  - To save the Matrix in a different folder, type the file path and file name in the **File name** box and then tap **Save**.

## Load a Matrix File

When you access the Matrix view, it shows the most recently-used Matrix. You can load a different Matrix from a previously-saved Matrix file.

**To load a Matrix file:**

1. In the **Matrix view**, tap **LOAD**.  
The **Open** dialog box appears.
2. Browse to the Matrix file you want to open, and then tap **Open**.  
**Tip:** Matrix files have a **.matrix** file extension.

# The Joystick Panel

You can control cameras manually using the **Legacy Joystick Panel** (Figure 70) or **CX-3R Joystick Panel** (Figure 71). The joystick panel enables you to move multiple axes of a camera simultaneously, for smooth camera operation.

This section includes the following topics:

- “**Control Precedence**” on [page 90](#)
- “**Joystick Panel Controls**” on [page 91](#)
- “**Joystick Control Settings**” on [page 101](#)

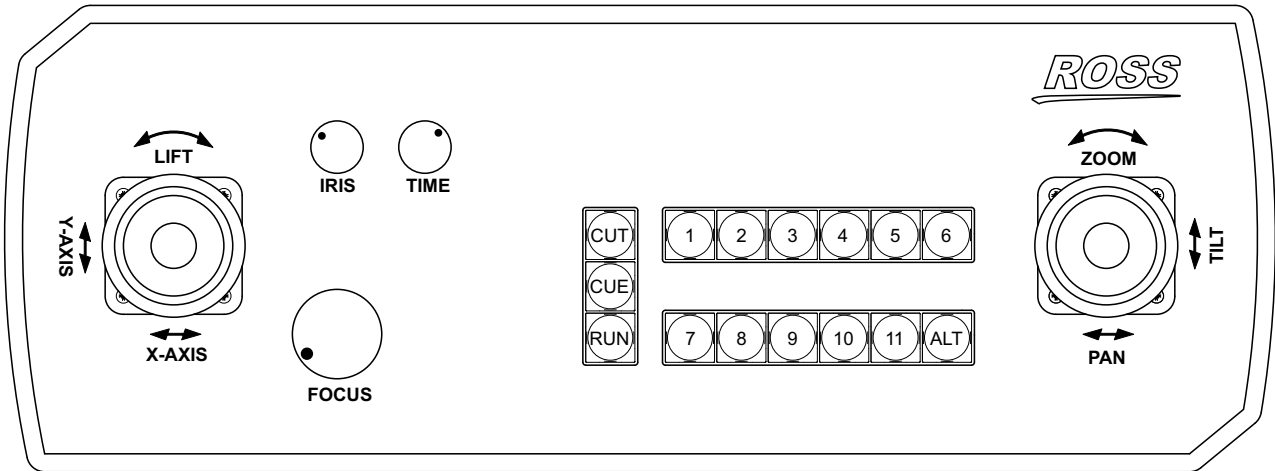


Figure 70 - Legacy Joystick Panel (may not appear exactly as shown)

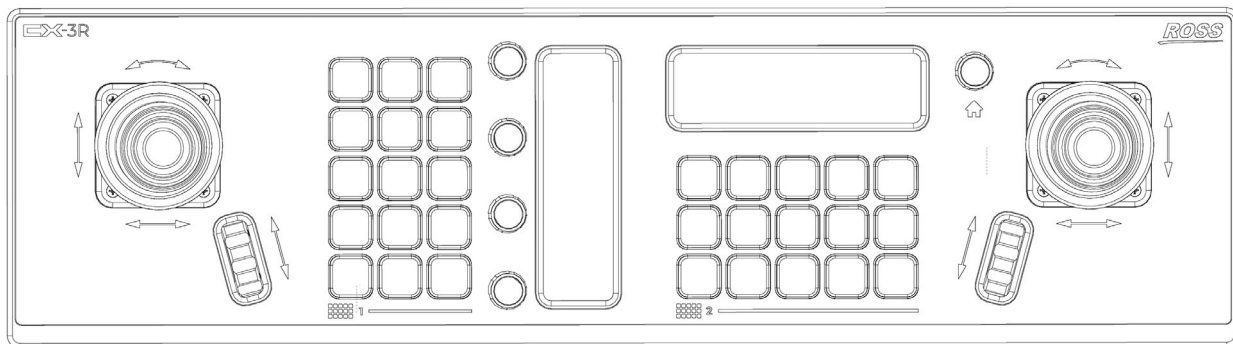


Figure 71 - CX-3R Joystick Panel (may not appear exactly as shown)

Alternatively, you can use the **Axis Control** panel in SmartShell to control cameras manually. For more information, see “**Manual Operation in SmartShell**” on [page 139](#).

## Control Precedence

Robots can be controlled by recalling shots and moves, or by joystick control or using buttons in the **Axis Control** panel. This section describes which control inputs take precedence.

### Control precedence for CamBot robots running CamBot firmware, and Vinten robots, is as follows:

- While a preset recall is in progress, all axes remain available for joystick control, except the XY axis on XY pedestals.
- If the system receives a preset recall request while it is still processing joystick control input from the operator, the request fails and a message appears. It is important to note that the system continues to process joystick control input during robot deceleration, after the operator has released the joystick or **Axis Control** buttons.

### Control precedence for Furio robots, and CamBot XY pedestals running Furio firmware, is as follows:

- For all robots running Furio firmware version 5.0 (or higher) — While the recall of a move or preset is in progress, all axes remain available for joystick control, except the XY axis of CamBot XY pedestals.
- For Furio robots running firmware version 4.x — If a preset recall or move is in progress, joystick control of each affected axis is unavailable until all automated movement of that axis is complete. Control of axes is individualized, so when automated movement of an axis is complete, the axis becomes available for joystick control even if the preset or move is still running.
- For Furio robots only — If the system receives a preset recall or move request while it is still processing joystick control input from the operator, the request fails and a message appears. It is important to note that the system continues to process joystick control input during robot deceleration, after the operator has released the joystick or **Axis Control** buttons.

## Joystick Panel Controls

The Legacy Joystick Panel and CX-3R Joystick Panel share some similar components, but each has its own unique offerings. This section described the panel controls for each.

### Legacy Joystick Panel

This section describes how the joystick controls work. Joystick controls include:

- **Left Joystick** — Controls left column height, floor movement for XY pedestals, and track motion for Furio dollies.

When controlling XY movement:

- › If the pedestal approaches an X-axis limit or Y-axis limit, it turns to avoid violating the limit, but continues to move along the other axis (X or Y) as requested by the joystick.
- › If you want to rotate the pedestal without affecting the pan position of the head, press and hold the left joystick while twisting it.

In some Ross Robotics systems, the joystick panel does not include a left joystick. If your system does not include Furio track-mounted dollies, lift columns, or XY pedestals, your joystick panel may not include a left joystick.

- **Right Joystick** — Controls pan, tilt, and lens zoom. The right joystick button temporarily disables variable zoom (ZOOMVAR).
- **Joystick Buttons** — If you are controlling a CamBot XY pedestal, press and hold both joystick buttons, and then push the joysticks forward and back to drive the pedestal. Control is similar to controlling a tracked vehicle. This feature does not apply to Vinten XY pedestals.
- **IRIS knob** — Adjusts the iris setting.
- **TIME knob** — Adjusts the recall duration for a preset when you are adding or editing it, or just before you run it. Also adjusts the duration of an action while it is running.

Depending on how your system is configured by your administrator, the **TIME** knob works in one of the following ways:

- › To adjust the recall duration of a preset while you are adding, editing, or just about to run it, turn the **TIME** knob. To change the duration of a preset, move, or macro while it is running, press and hold the **ALT** button and turn the **TIME** knob.

- › To adjust the recall duration of a preset while you are adding, editing, or just about to run it, press and hold the **ALT** button and turn the **TIME** knob. To change the duration of a preset, move, or macro while it is running, turn the **TIME** knob.
  - **FOCUS knob** — Rotate to adjust the lens focus, or press the knob to enter or exit **Quick Focus** mode. Quick Focus does not apply to Vinten robots. For more information about the **Quick Focus** feature, see “**Using Quick Focus to Fine-Tune the Focus**” on [page 141](#).
  - **CUT button** — Moves the camera to the selected preset position as quickly as possible. This button is operational for Panel mode only.
  - **CUE button** — Prepares a preset (CamBot XY pedestal only) or a move before you recall it. The **CUE** button does not apply to Vinten robots. This button is operational for Panel mode only.
  - **RUN button** — Moves the camera to the selected preset or move position in the specified time period, if possible. This button is operational for Panel mode only.
  - **ALT button** — Enables you to perform alternative functions, including the following:
    - › Enables the **TIME** knob to do one of the following, depending on how the system is configured:
      - › Modify the duration of a preset, move, or macro while it is running. To modify the duration, press and hold the **ALT** button, and then turn the **TIME** knob clockwise to increase the duration or counter-clockwise to decrease it.
      - › Modify the duration of a preset when you are adding, editing, or just about to run it. To modify the duration, press and hold the **ALT** button, and then turn the **TIME** knob clockwise to increase the duration or counter-clockwise to decrease it.
- Tip:** When operating a CamBot, the **ALT** button is normally yellow. When you press the button, it turns green unless the camera is on-air, in which case it turns red. The red on-air indicator applies only if your system includes tally integration.
- **Camera Selection buttons (1 - 11)** — Each button selects/deselects a camera to control. Only one camera can be selected at a time.

## CX-3R Joystick Panel

The CX-3R Joystick Panel provides direct control over robotic cameras, allowing operators to select cameras, adjust positioning, execute presets, and modify move timing. Each control is mapped to a specific function within SmartShell, eliminating the need for hidden commands or multi-step inputs.

This section outlines how to use the joysticks, rollers, camera selection buttons, and action buttons for manual operation and preset execution.

**Figure 72** - CX-3R Joystick Panel Operation Capabilities



### Joystick Control

The CX-3R Joystick Panel features two joysticks for precise manual control of robotic camera movement.

#### Left Joystick

The left joystick controls camera movement along the X and Y axes, but its function depends on the robot type and steering mode:

- For track-based robots – Move left/right shifts the camera along the X-axis (track movement).
- For XY pedestals – Movement is affected by the selected steering mode, which determines how X and Y inputs are interpreted.
- Twisting the joystick raises or lowers the camera's lift column (if applicable).

#### Right Joystick

The right joystick controls camera rotation and zoom.

- Move up/down to tilt the camera.
- Move left/right to pan the camera.
- Twist the joystick to zoom in or out by adjusting the camera lens.

### Camera Selection Buttons

Assigns control to a specific robotic device within SmartShell. Camera names are auto-update from SmartShell.

**Figure 73** - CX-3R Joystick Panel Camera Selection Buttons



These button border colors dynamically update to reflect assigned camera names and tally status:

- **Red** – Camera is ON AIR.
- **Blue** – Camera is selected but NOT ON AIR.
- **Grey** – Camera is OFF AIR.

If the buttons display default numbers instead of camera names, check if SmartShell is connected to the Adapter Service. If the connection is not established, SmartShell cannot assign camera names to the buttons.

## Control Knobs

The CX-3R Joystick Panel includes four control knobs that provide manual adjustments for iris settings and movement timing. The Knob Display Screen displays the current assignments for these knobs.

### Iris Knob (Top)

- Controls iris settings, adjusting lens brightness.
- Turn the knob to manually increase or decrease the iris value.
- Turning the knob adjusts the iris value, which is reflected in SmartShell's camera controls.

### Duration Knob (Bottom)

- Adjusts the execution time for a preset or move.
- Turn the knob to modify how long a move takes to complete.
- Affects standard Run recalls only and does not impact **Cue / Cut** or **Alternate Cue / Cut** timing which is predefined

**Note:** The two middle knobs are reserved for future functionality and do not have assigned functions in the current software version.

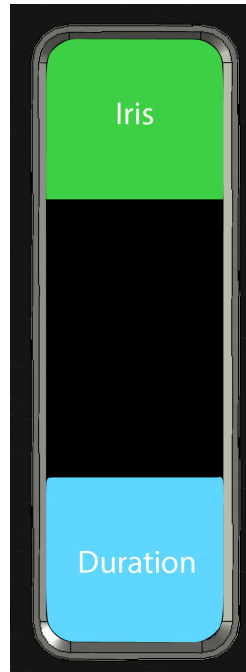
## Display Screens

The CX-3R Joystick Panel includes two display screens that provide real-time feedback and system configuration options.

### Knob Display Screen

Displays the current assignments for the **Iris Knob** and **Duration Knob**. Iris and duration changes are shown in SmartShell's camera controls.

**Figure 74** - CX-3R Joystick Panel Knob Display Screen



### Configuration Touch Screen

This touchscreen interface allows operators to manage network setup, SmartShell connection, and panel assignment.

**Figure 75** - CX-3R Joystick Panel Configuration Display Screen



The configuration touch screen:

- Is used for network setup, panel assignment, and system configuration.
- Allows users to:
  - › Set the panel's IP address.
  - › Verify SmartShell connection status.

For detailed configuration steps, refer to the **CX Panel Hardware Setup Guide (4902DR-001-01)**.

## Home Knob

Pressing the Home Knob opens the touchscreen display, allowing the user to select either operation mode or configuration mode.

The knob functions as follows:

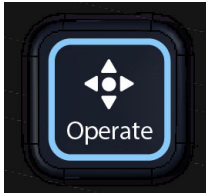

- Press the Home Knob to switch between system settings and live operation.
- In configuration mode, use the Configuration Touch Screen to adjust panel settings such as network setup and panel assignment.
- In operation mode, the panel returns to normal camera control functions.







## Action Buttons



Provides direct access to preset execution, move adjustments, and system commands.

**Figure 76** - CX-3R Joystick Panel Camera Selection Buttons  
(button appearance subject to available functionality)



Button	Function
<p><b>Operate</b></p> 	<p>Grants control of the robot to the operator or SmartShell station. When another client is controlling the robot, pressing Operate can prompt a confirmation pop-up in SmartShell before transferring control, depending on the SmartShell configuration.</p>
<p><b>Force Operate OFF</b></p> 	<p>Bypasses the SmartShell confirmation prompt, allowing the user to immediately take control.</p>

Button	Function
<p><b>Focus</b></p> 	<p>Opens the Quick Focus window in SmartShell and zooms the camera in tightly, allowing the operator to manually adjust focus. Pressing the button again closes the Quick Focus window and restores the previous zoom value. Manual focus can still be adjusted using the Focus Roller or Joystick Twist.</p>
<p><b>Halt</b></p> 	<p>Stops all robotic motion immediately but does not disable joystick control or require reactivation. Unlike an E-stop, the system remains operational, and the joystick can still be used for manual control. Halt only stops a preset or move that is currently in progress, and the stopping behavior may be more gradual than an E-stop.</p>
<p><b>Cut</b></p> 	<p>Moves the camera as quickly as possible to the stored preset position without synchronizing axes.</p> <p>This button is operational for Panel mode only.</p>
<p><b>Slow Cut</b></p> 	<p>Moves the camera to the stored preset position at a reduced speed, based on a predefined value. The speed reduction is configured in the robot template and may be adjustable within SmartShell, depending on user permissions.</p> <p>This button is operational for Panel mode only.</p>
<p><b>Cue</b></p> 	<p>Prepares a move or preset without executing it. This allows the operator to line up a move before running it.</p> <p>This button is operational for Panel mode only.</p>
<p><b>SlowCue</b></p> 	<p>Executes a slower version of Cue, applying a predefined speed reduction.</p> <p>This button is operational for Panel mode only.</p>

Button	Function
<p data-bbox="418 222 472 247"><b>Run</b></p> 	<p data-bbox="634 222 1406 317">Executes a preset or move over a specified duration, which is set in SmartShell before execution. While the move is in progress, the Active Duration Roller can be used to adjust the duration.</p> <p data-bbox="634 365 1182 390">This button is operational for Panel mode only.</p>
<p data-bbox="347 485 544 510"><b>Vision[Ai]ry On</b></p> 	<p data-bbox="634 485 992 510">Activates Vision[Ai]ry tracking.</p> <p data-bbox="634 516 1349 575"><b>Note:</b> If the system is not configured for Vision[Ai]ry, an error message will appear in SmartShell.</p>

## Rollers

### Focus Roller (Left Roller)

The Focus Roller adjusts focus when rolled up or down. The effect depends on the lens in use and operates independently of the Focus button, which opens the Quick Focus window in SmartShell.

### Active Duration Roller (Right Roller)

The Active Duration Roller controls the speed of presets or moves while they are in progress:

- Adjusts recall execution time when performing a **Run** action.
- Does not affect a **Cut / Cue** or **Slow Cue / Slow Cut**, which have predefined timing.

## Camera Control with a Joystick Panel

Follow these steps to control cameras using either the Legacy Joystick Panel or the CX-3R Joystick Panel.

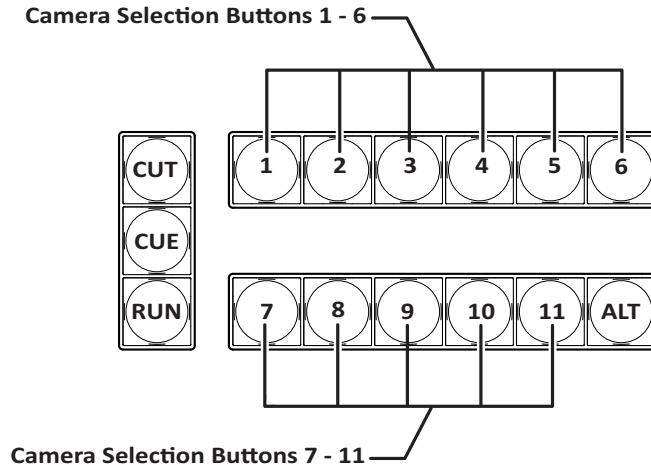
### To control a camera using the Joystick Panel:

1. On the joystick panel, if the **Camera Selection** button corresponding to the camera you want to control is not highlighted, press the button.

**Note:** [Figure 77](#) shows the **Legacy Joystick Panel** and [Figure 78](#) shows the **CX-3R Joystick Panel**.

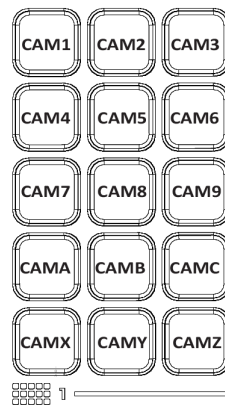
**Tip:** The camera names appear at the top of the main SmartShell interface, in the same order as the camera selection buttons on the joystick panel.

**Note:** The **CX-3R Joystick Panel** will also display the name of the assigned camera in the button, and selected camera buttons turn blue.



**Figure 77** - Camera Selection Buttons on the Legacy Joystick Panel

### Camera Selection Buttons 1 - 15



**Figure 78** - Camera Selection Buttons on the CX-3R Joystick Panel

**Tip:** Alternatively, there are two ways you can select a camera using the SmartShell interface:

- › In the main window, tap the camera button for the camera you want to control.
- › In the Matrix view, tap a Matrix button that uses the camera you want to control.

The camera selection button turns green, unless the camera is on-air and your system includes a tally interface, in which case it remains red.

In SmartShell, the view changes to show values and controls for the selected camera.

- In SmartShell, in the **Axis Activation** panel, ensure the axes you want to control are activated for joystick control. In [Figure 79](#), only the **PAN** and **TRACK** axes are activated. Tap an axis name to change its status between enabled (green dot) and disabled (red dot).



**Figure 79** - Axis Activation Panel with PAN and TRACK Axes Activated

- Use the joystick panel controls to move the selected camera.  
**Tip:** If the joystick controls are unresponsive, check the **Axis Control** panel in SmartShell to ensure that **Axis Jog Mode** is not on.

[Table 1](#) describes how to use the joystick panel to achieve desired movements:

**Table 1 - Summary of Joystick Panel Movement Controls (default behavior)**

Desired Movement	Action to Perform
Pan the camera right or left	Push the right joystick to the right or left.
Tilt the camera view up or down	Push the right joystick forward or pull it backward.
Zoom in or out (lens control)	Twist the right joystick.
Temporarily disable variable zoom while moving certain axes (pan, tilt)	Press the button on the right joystick while moving affected axes. Variable zoom values are ignored. Variable zoom varies the speed of the affected axis with the value of the zoom axis to make the motion appear smoother. When the lens is zoomed in, the affected axis moves more slowly. When the lens is zoomed out, the affected axis moves more quickly. For information about configuring variable zoom, see “ <b>Set the Variable Zoom Ratio for Manual Operation</b> ” on <a href="#">page 113</a> .
To adjust the iris	Turn the <b>IRIS</b> knob. <b>Note:</b> If you have a third-party remote camera control panel, you can configure your system to control iris from that panel and from the Ross Video Joystick Panel: <ul style="list-style-type: none"> <li>• <b>To control iris from both panels</b> — iris demand must be routed to the video camera instead of the robot. Ross Robotics achieves this through various camera paint options it sells.</li> <li>• <b>To control iris from only the Ross Video Legacy Joystick Panel or CX-3R Joystick Panel</b> — iris demand is routed to the robot.</li> </ul> For more information, contact Ross Video Technical Support.
Focus nearer or farther (lens control)	For the <b>Legacy Joystick Panel</b> , turn the <b>FOCUS</b> knob. Alternatively, to fine-tune focus while the selected camera is not on-air, press the <b>FOCUS</b> knob to use the <b>Quick Focus</b> feature. For more information about the <b>Quick Focus</b> feature, see “ <b>Using Quick Focus to Fine-Tune the Focus</b> ” on <a href="#">page 141</a> . For the <b>CX-3R Joystick Panel</b> , roll the <b>Focus</b> roller. Alternatively, to fine-tune focus while the selected camera is not on-air, press the <b>FOCUS</b> button to use the <b>Quick Focus</b> feature. For more information about the <b>Quick Focus</b> feature, see “ <b>Using Quick Focus to Fine-Tune the Focus</b> ” on <a href="#">page 141</a> .
Raise or lower the lift column	Twist the left joystick. This applies only to cameras that include a lift column.
Move a Furio dolly along the track	Push the left joystick to the right or left.

**Table 1 - Summary of Joystick Panel Movement Controls (default behavior)**

Desired Movement	Action to Perform
Move an XY pedestal left, right, forward, or backward	<p>Push the left joystick left, right, forward, or pull it backward.</p> <p>When using the joystick panel, the direction of XY motion is relative to either the target orientation (standard steering), or the pan axis position (pan-relative steering). For more information, see “<b>Standard Steering and Pan-Relative Steering for XY Pedestals</b>” on <a href="#">page 143</a>.</p> <p><b>IMPORTANT:</b> If the pedestal is not targeted, axis limits for the XY axis are ignored. Pedestal movement is not restricted to the area defined by the XY limits.</p> <p>If you are using a CamBot XY pedestal, before a pedestal starts to move across the floor, it rotates to align its wheels with the direction of motion. Rotation may delay the requested movement. To avoid the delay, rotate the pedestal before you need to move it.</p> <p>If you are using a CamBot XY pedestal, you can use buttons in the <b>Axis Control</b> panel to automatically align the pedestal wheels parallel or perpendicular to either the target (in standard steering mode), or to the pan position of the head (in pan-relative steering mode). For more information, see “<b>Aligning, Trucking, and Dollying XY Pedestals</b>” on <a href="#">page 142</a>.</p>
Rotate an XY pedestal in place without affecting the pan position	<p>Press and hold the button on the left joystick, and twist the left joystick.</p> <p><b>Tip:</b> When rotating the base in place, its rotational range is limited to +/- 180° from its home orientation of 0°.</p>
Drive a CamBot XY pedestal around the studio floor	<p>Press and hold both joystick buttons, and then use the joysticks to steer and drive.</p> <p><b>Note:</b> This feature does not apply to Vinten XY pedestals.</p> <p>The left joystick controls the left wheel, and the right joystick controls the right wheel. Push a joystick away from you to make the corresponding wheel roll forward, or pull the joystick towards you to make the wheel roll backward.</p> <p>When controlling XY movement:</p> <ul style="list-style-type: none"> <li>• If the pedestal approaches an X-axis limit or Y-axis limit, it turns to avoid violating the limit, but continues to move along the other axis (X or Y) as requested by the joystick.</li> <li>• If you want to rotate the pedestal without affecting the pan position of the head, press and hold the left joystick while twisting it.</li> </ul>

- When you are finished controlling cameras, you can deselect the camera by pushing its lit camera selection button.  
The camera selection button becomes unlit.

**Note:** Do not connect multiple joystick devices to a single SmartShell computer. Erratic behavior may result if more than one joystick device is connected.

## Joystick Control Settings

The SmartShell user interface includes the **Joystick Control Settings** view ([Figure 80](#)), which enables you to configure how each axis of each camera responds to manual control input. Manual control input includes control through a joystick panel, the **Axis Control** panel, and production switchers.

For example, you can set the maximum speed and damping ratio for the pan axis of a specific camera.

You can save settings in user settings files (**.usettings**). You can create separate user settings files for each operator, for each show, or for any other purpose.

Before you configure and save joystick control settings, ensure that all cameras are fully operational and connected to SmartShell.



Figure 80 - Joystick Control Settings View

This section includes the following topics, which describe the Joystick Control Settings view and how to use it:

- “Accessing the Joystick Control Settings View” on [page 102](#)
- “Understanding Global Values and Override Values” on [page 103](#)
- “Types of Joystick Control Settings” on [page 103](#)
- “Joystick Control Settings Interface” on [page 104](#)
- “Configuring Joystick Control Settings” on [page 108](#)
- “Interpreting Joystick Settings Graphics” on [page 113](#)
- “Configuring Joystick Settings for an Entire Ross Robotics System” on [page 117](#)

**Tip:** Alternatively, you can adjust joystick control settings in the Axis Control panel. The Axis Control panel does not enable you to save settings or to copy them to other cameras. For more information, see “Configure Camera Response to Manual Controls” on [page 112](#).

## Accessing the Joystick Control Settings View

To access the Joystick Control Settings view:

- Tap the **Joystick Settings** button.  
The button background turns blue, and the Joystick Control Settings view appears.



**Figure 81** - Joystick Settings Button (before selection)

## Understanding Global Values and Override Values

The Joystick Control Settings view enables you to configure how each axis of each camera responds to joystick movements. Each axis has multiple settings, such as a **SPEED** slider or **INVERT** check box, that can be configured individually.

You can specify global values, which are defaults that may be applied to any camera. You can also specify override values for individual cameras. You can save global values and override values in a user settings file.

A user settings file contains global values for all settings on all axes. It may also contain override values for one or more cameras.

When you load a user settings file and then apply its values to a camera, the file's global values are applied for each setting unless the file contains an override value for that setting. For example, if the file contains a global **PAN SPEED** value of **50**, and also contains an override **PAN SPEED** value of **70** for the selected camera, the resulting **PAN SPEED** is **70**.

The following example scenario illustrates how global values and override values are applied:

1. You set the global value for **TRACK SPEED** to **50**, and then save the settings to a new user settings file.
2. You select **Camera A**, tap **OPERATE** to apply the file settings, set the **TRACK SPEED** value to **75**, and then save to the same user settings file.  
The file now contains an override value of **75** for the **TRACK SPEED** setting for **Camera A**.
3. Someone else uses the system and applies settings from a different user settings file.
4. Later, you use the system. You load your user settings file, select **Camera A**, and then tap **OPERATE** to apply the file settings.  
The **TRACK SPEED** value is now **75**, because the override value of **75** overrides the global value of **50**. The **OVERRIDE** check box beside the **TRACK SPEED** slider is selected, indicating that an override value is in use.
5. You select **Camera B**, and then tap **OPERATE** to apply settings from the loaded user file.  
The **TRACK SPEED** value is **50**, which is the global value, because the user settings file does not include an override **TRACK SPEED** value for **Camera B**. The **OVERRIDE** box beside the **TRACK SPEED** slider is not selected because the **TRACK SPEED** setting is not using an override value.

**Tip:** After you apply settings from a user file to a camera, you can adjust settings for that camera. These changes take effect immediately, overriding values from the user settings file.

## Types of Joystick Control Settings

Values can be configured for each joystick control setting on each axis of each camera.

Each axis has several settings that can be configured. Each setting has an **OVERRIDE** check box.

If a user settings file is loaded, settings are color-coded to indicate whether the current values match values from the file. For more information, see "**Interpreting Joystick Settings Graphics**" on [page 113](#).

### **Axis Settings**

The following types of settings can be configured:

- **SPEED slider** — Sets the maximum travel speed of the axis.

Lower values are slower. Higher values are faster.

To adjust a slider, tap and drag the slider handle, or tap the line the slider handle is on.

- **DAMPING slider** — Sets the responsiveness of the axis to joystick requests, which affects the smoothness of motion when accelerating and decelerating.

Lower values yield harder acceleration and deceleration. Higher values yield softer acceleration and deceleration.

To adjust a slider, tap and drag the slider handle, or tap the line the slider handle is on.

- **ZOOMVAR slider (variable zoom ratio)** — Sets the degree to which the speed of the affected axis varies with the position of the zoom axis.

**ZOOMVAR** is used to achieve smoother motion in close up shots. If the **ZOOMVAR** value is higher than **0**, the axis moves more slowly when the lens is zoomed in than it does when the lens is zoomed out.

Lower values yield lower variability. Higher values yield higher variability. A value of **0** turns **ZOOMVAR** off.

This setting is not available for all axes. It is shown only if it is available.

To adjust a slider, tap and drag the slider handle, or tap the line the slider handle is on.

- **Pan Relative check box** — Sets whether pan-relative steering is activated, as opposed to standard steering. For more information, see “**Standard Steering and Pan-Relative Steering for XY Pedestals**” on [page 143](#).

This setting appears only for the **XY** axis of XY pedestals.

To reverse the state of a check box, tap the check box.

- **INVERT check box**— When selected, reverses the direction that the axis moves when you move the joystick.

For example, if a Furio SE Studio dolly moves right when you push the joystick left, you can invert the axis to make the dolly motion correspond with the joystick motion.

To reverse the state of a check box, tap the check box.

### **OVERRIDE Check Boxes**

**OVERRIDE** check boxes function differently depending on whether you are configuring camera values or global values:

- **OVERRIDE check box (when configuring camera values)** — Each **OVERRIDE** check box is associated with the setting beside it, such as a **SPEED** slider or an **INVERT** check box. The **OVERRIDE** check box indicates whether the associated setting’s current value is an override value or a global value:

- › **Cleared** — The current setting value is the global value.

- › **Selected** — The current value is an override value.

If the **OVERRIDE** check box is selected, the color of the setting (such as a slider or **INVERT** check box) indicates the source of the override value:

- › **White slider or blue check box** — The override value matches the override value specified in the loaded user setting file. These colors are also present if no user settings file is loaded.

- › **Orange slider or orange check box** — The override value was set manually, and does not match the override value specified in the loaded user setting file.

- **OVERRIDE check boxes (when configuring global values)** — **OVERRIDE** check boxes appear selected unless there is no global value defined. You cannot select or clear them. When configuring global values, ignore the **OVERRIDE** check boxes.

## Joystick Control Settings Interface

[Figure 82](#) and the sections that follow describe the Joystick Control Settings interface.

**Tip:** The letters in [Figure 82](#) identify buttons and areas of the interface that are described in the sections that follow. If you are reading this document on a computer, tap the lettered buttons or areas of the diagram to jump to the descriptions.

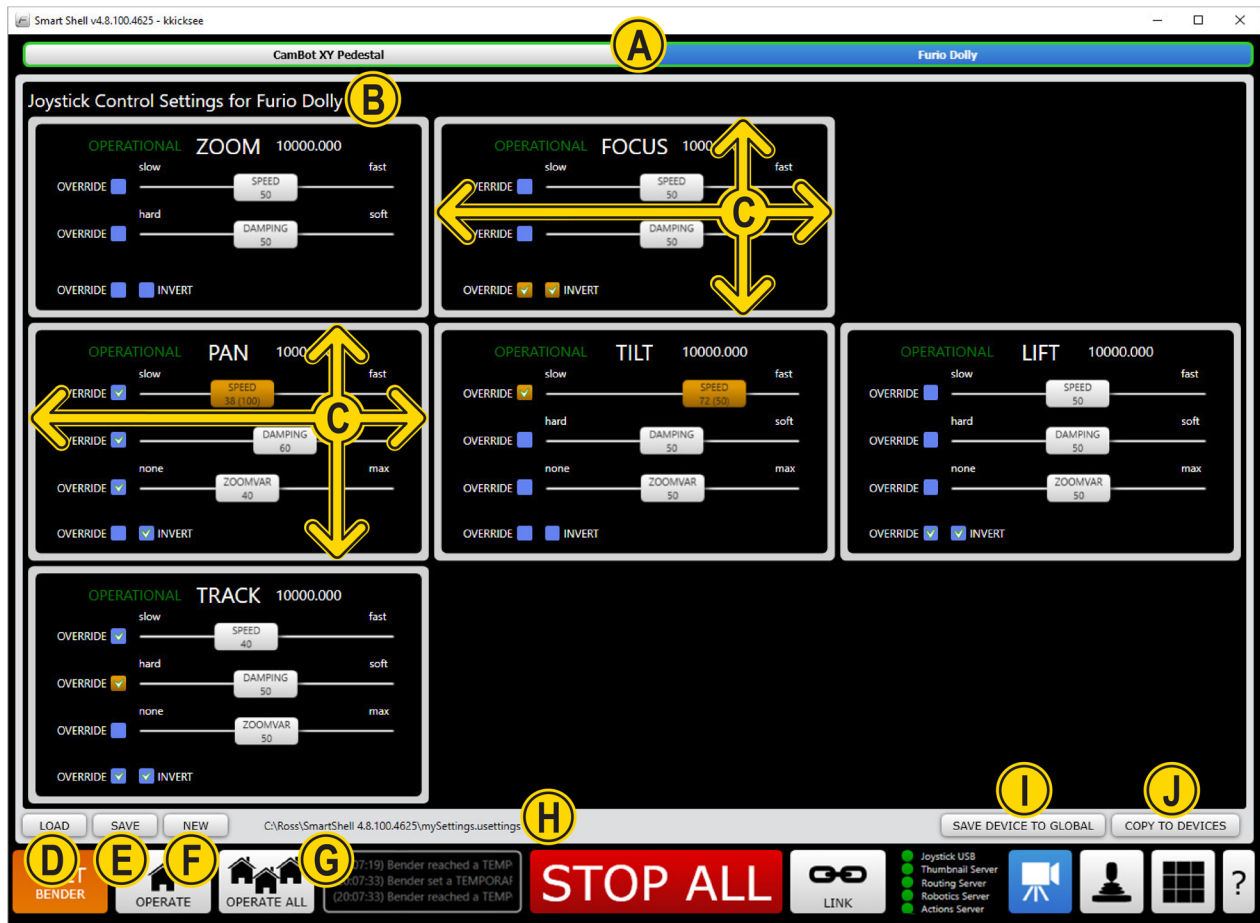


Figure 82 - Joystick Control Settings Interface

### **A** Camera Selection Panel

The **Camera Selection** panel (Figure 83) indicates the connection status, selection status, and manual control status of all robotic cameras. It includes one camera button for each robotic camera.

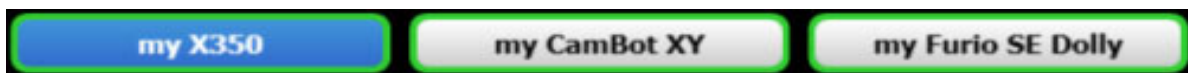


Figure 83 - Camera Selection Panel

If no camera is selected (no blue button), the Joystick Control Settings interface shows global values, which may apply to all cameras.

If a camera is selected (blue button), the Joystick Control Settings interface shows values for that camera, which may override global values.

For more information about global values and override values, see **“Understanding Global Values and Override Values”** on [page 103](#).

Click [HERE](#) to view the joystick control settings interface diagram.

### **B** Title

The title indicates whether the interface currently displays global values, or values for a specific camera. The title is always one of the following:

- **Joystick Control Settings for GLOBAL**

If no camera is selected, the Joystick Control Settings interface displays global values, which are defaults that may be used by any camera.

- **Joystick Control Settings for <camera\_name>**

If a camera is selected, either in the Camera Selection panel or on the Joystick panel, the Joystick Control Settings interface displays values for that camera.

For more information about global values and override values, see “**Understanding Global Values and Override Values**” on [page 103](#).

Click [HERE](#) to view the joystick control settings interface diagram.

### **C** Axis Panels

Each axis panel ([Figure 84](#)) contains joystick control settings for the axis listed at the top of the panel.



*Figure 84 - An Axis Panel (TILT)*

If you are editing global values, all axis panels are shown.

If you are editing values for a specific camera, only the axis panels that apply to that camera are shown. For example, a Furio dolly does not have an XY axis.

For information about the settings you can adjust, see “**Types of Joystick Control Settings**” on [page 103](#).

For information about interpreting graphics in the axis panels, see “**Interpreting Joystick Settings Graphics**” on [page 113](#).

Click [HERE](#) to view the joystick control settings interface diagram.

### **D** LOAD Button

Tap the **LOAD** button to select and open a user settings file.

When the file loads, the file path and file name appear near the bottom of the interface.

**Note:** Loading a user settings file by tapping the **LOAD** button does not automatically apply the loaded values. For more information, see “**Load a User Settings File**” on [page 110](#).

Click [HERE](#) to view the joystick control settings interface diagram.

### **E** SAVE Button

Tap the **SAVE** button to save the current values to a user settings file.

You can save values to the currently loaded file, a different file that already exists, or to a new file.

When you save values to an existing user settings file, SmartShell edits the file to save the values as shown at the time, but does not modify other values in the file:

- If you save while global values are shown, the global settings in the file are updated to reflect the values shown.
- If you save while settings for a camera are shown, the override settings for that camera are updated to reflect the values shown. If the file contains override settings for other cameras, they remain unchanged.

Click [HERE](#) to view the joystick control settings interface diagram.

### **F** ***NEW Button***

Tap the **NEW** button to dismiss the user settings file, so no file is loaded.

Dismissing the user settings file is useful if you want to operate the system without one, or you want to configure and save all new joystick control setting values for your entire Ross Robotics system.

For more information, see “**Dismiss the User Settings File**” on [page 108](#).

Click [HERE](#) to view the joystick control settings interface diagram.

### **G** ***OPERATE Button***

Tap the **OPERATE** button to apply joystick control setting values from the loaded user settings file.

When you apply values from the file, only the selected camera’s settings are affected. For example, if **Camera A** is selected when you apply the values, only values for **Camera A** are applied.

When you apply setting values from a user settings file, the file’s global values are applied for each setting unless the file contains an override value for that setting. For more information, see “**Understanding Global Values and Override Values**” on [page 103](#).

Click [HERE](#) to view the joystick control settings interface diagram.

### **H** ***User Settings File Path and File Name Area***

This area displays the file path and file name of the loaded user settings file (**.usettings** file).

If no user settings file is loaded, this area is blank.

Click [HERE](#) to view the joystick control settings interface diagram.

### **I** ***SAVE DEVICE TO GLOBAL Button***

Tap the **SAVE DEVICE TO GLOBAL** button to save the selected camera’s joystick control setting values as global values.

You can save the values to an existing file, or to a new file.

For more information, see “**Saving the Currently-Selected Camera’s Settings as Global Settings**” on [page 112](#).

Click [HERE](#) to view the joystick control settings interface diagram.

### **J** ***COPY TO DEVICES Button***

Tap the **COPY TO DEVICES** button to save the selected camera’s current setting values to a user settings file as override values for one or more cameras, and/or as global values.

For each camera, you can specify whether the file settings are affected. You can also specify whether the global file settings are affected.

Copying setting values does not automatically apply them to any cameras. After you copy values, you can review and apply them to each of the cameras you chose when you copied the settings.

For more information, see “**Copying Setting Values to Other Cameras**” on [page 111](#).

Click [HERE](#) to view the joystick control settings interface diagram.

## Configuring Joystick Control Settings

This section describes tasks you can perform using the Joystick Control Settings view.

This section includes the following topics:

- “**Dismiss the User Settings File**” on [page 108](#)
- “**Configure and Save Global Settings**” on [page 108](#)
- “**Configure and Save Override Settings for a Camera**” on [page 109](#)
- “**Load a User Settings File**” on [page 110](#)
- “**Review and Apply Camera Settings**” on [page 111](#)
- “**Copying Setting Values to Other Cameras**” on [page 111](#)
- “**Saving the Currently-Selected Camera’s Settings as Global Settings**” on [page 112](#)

For a single workflow procedure that describes how to configure joystick control settings for your entire Ross Robotics system, see “**Configuring Joystick Settings for an Entire Ross Robotics System**” on [page 117](#).

### ***Dismiss the User Settings File***

You can dismiss the current user settings file, so no file is loaded.

Dismissing the user settings file is useful if you want to do one of the following:

- Operate the system without a user settings file. With no user settings file loaded, you can adjust joystick control settings without any of the setting values turning orange.

Configure and save all new joystick control setting values for your entire Ross Robotics system. For more information, see “**Configuring Joystick Settings for an Entire Ross Robotics System**” on [page 117](#).

When you dismiss the user settings file, the current joystick setting values on camera systems do not change. All global slider values revert to **50**, and all global check boxes are cleared. If any cameras have current joystick values that are not the same as the global values (**50** for sliders, all check boxes cleared), the **OVERRIDE** boxes for those camera values are selected. No settings appear orange.

**Tip:** If a folder name and file path is visible near the bottom of the interface, a user settings file is currently loaded.

### **To dismiss the user settings file:**

- Tap the **NEW** button.  
Note that the interface no longer shows a user settings folder path or file name.

### ***Configure and Save Global Settings***

You can review global settings, adjust their values if required, and save them.

Global settings are defaults that may be applied to any camera. When you load a user settings file and then apply its values to a camera, the file’s global values are applied for each setting unless the file contains an override value for that setting. For more information about global settings, see “**Understanding Global Values and Override Values**” on [page 103](#).

**Note:** Adjusting global settings does not automatically apply the updated global values to any cameras. To apply updated global values, you must save the setting values and then apply them to each camera.

**Note:** If you want to test global values as you adjust them, you can configure settings for a camera and then save those values as global values. If you have multiple types of robots, you may need to do this on more than one camera to ensure that you configure global values for all axes. For more information, see “**Saving the Currently-Selected Camera’s Settings as Global Settings**” on [page 112](#).

**To review, adjust, and save global settings:**

1. Deselect the currently-selected camera so the title near the top of the interface is **Joystick Control Settings for GLOBAL**.
2. Do one of the following:
  - If you loaded a user settings file, review the global setting values, and if you are satisfied with them, skip the rest of this procedure.
  - If you want to configure all new joystick control setting values for your entire Ross Robotics system, tap the **NEW** button to dismiss the loaded user settings file.  
For more information, see “**Dismiss the User Settings File**” on [page 108](#).
3. Review the global setting values and adjust them as required.

**Tip:** If a user settings file is loaded and you change a value, it turns orange to indicate that the new value is different than the value from the file.

**Tip:** If a user settings file is loaded and you want to cancel your changes, reload the file.

For information about the settings you can adjust, see “**Types of Joystick Control Settings**” on [page 103](#).

For information about interpreting graphics in the interface, see “**Interpreting Joystick Settings Graphics**” on [page 113](#).
4. When you are ready to save your changes, tap the **SAVE** button.

**Note:** Unless you save your changes, they are lost when you select a camera, load a user settings file, or close SmartShell.
5. When the **CONFIRM SAVE** message appears, tap **YES**.  
The **Save User Settings File** dialog box appears.  
If a user settings file is loaded, the file name appears in the **File name** box.
6. Do one of the following:
  - If a user settings file is loaded and you want to update it with your changes, tap the **Save** button.
  - If you want to save the changes in a new or different user settings file:
    - › Browse to the folder where you want to save the user settings file.
    - › If you want to save changes in an existing file, select the file.
    - › If you want to create a new file, in the **File name** box, type a name for the file.
    - › Tap the **Save** button.
    - › If the **Override UserSettings File** message appears, tap **YES**.

**Note:** If you saved the changes to a new or different file, that file is automatically loaded into the Joystick Control Settings interface.

**Configure and Save Override Settings for a Camera**

A user settings file contains global values for all settings on all axes. It may also contain override values for one or more cameras. When you load a user settings file and then apply its values to a camera, the file’s global values are applied for each setting unless the file contains an override value for that setting.

This section describes how to configure override values for a camera, and how to save those values in a user settings file.

When you configure values for a camera, you specify how the camera's values differ from the global values. Before you configure values for cameras, configure and save the global values. For more information, see “**Configure and Save Global Settings**” on [page 108](#).

**To configure and save override values for a camera:**

1. Tap the **LOAD** button to load the user settings file you want to update.  
For more information, see “**Load a User Settings File**” on [page 110](#).
2. Select the camera you want to configure.  
The interface indicates differences between current joystick setting values and those in the file. Current values are shown, but are colored orange if they are different than the file settings. For more information, see “**Interpreting Joystick Settings Graphics**” on [page 113](#).
3. If you want to set the camera's settings to global values as a starting point, tap **OPERATE**, clear all **OVERRIDE** check boxes, and then save the file. The file is updated to remove all override values for the camera.
4. Review and adjust the values as required.  
**Tip:** When you adjust settings, the changes take effect immediately. You can use the joystick panel and the camera to test the setting values as you adjust them.  
For information about the settings you can adjust, and about interpreting graphics in the interface, see “**Interpreting Joystick Settings Graphics**” on [page 113](#).
5. If you do not want to save your changes, skip the rest of this procedure.
6. When you are ready to save your changes, tap the **SAVE** button.
7. When the **CONFIRM SAVE** message appears, tap **YES**.  
The **Save User Settings File** dialog box appears.  
If a user settings file is loaded, the file name appears in the **File name** box.
8. Do one of the following:
  - If a user settings file is loaded and you want to update it with your changes, tap the **Save** button.
  - If you want to save the changes in a new or different user settings file:
    - › Browse to the folder where you want to save the user settings file.
    - › If you want to save changes in an existing file, select the file.
    - › If you want to create a new file, in the **File name** box, type a name for the file.
    - › Tap the **Save** button.
    - › If the **Override UserSettings File** message appears, tap **YES**.

**Note:** If you saved the setting values in a different file, that file is automatically loaded into the Joystick Control Settings interface.
9. If you want to configure and save settings for another camera, repeat 2 to 8.

### **Load a User Settings File**

You can load an existing user settings file in one of two ways:

- Tap the **LOAD** button in the joystick control settings interface.  
Tapping the **LOAD** button and selecting a user settings file does not automatically apply the file setting values to any cameras. After you load the file, you can compare current joystick settings to the file setting values, and then decide whether to apply the file setting values to individual cameras. Each time you select a camera the interface indicates differences between current joystick setting values and those in the file. Current values are shown, but are colored orange if they are different than the file setting values. For more information, see “**Interpreting Joystick Settings Graphics**” on [page 113](#).
- Press the **s** key on the keyboard  
Pressing the **s** key on the keyboard and selecting a user settings file loads and applies the file's settings immediately. Depending on how your system is configured, the settings are applied to either the selected camera, or to all cameras.

#### To load a user settings file:

1. Do one of the following:
  - If you want to load, review, and apply settings for the selected camera, tap the **LOAD** button.
  - If you want to load and apply settings immediately, press the **s** key on the keyboard.The **Open User Settings File** dialog box appears.
2. Browse to the user settings file you want to load, and then tap the **Open** button.

**Note:** User settings file names have a **.usettings** file extension. For example, **myFile.usettings**. The file loads. The folder path and file name appears near the bottom of the interface.

After you load a user settings file, you may want to do one or more of the following:

- “**Configure and Save Global Settings**” on [page 108](#)
- “**Review and Apply Camera Settings**” on [page 111](#)

#### **Review and Apply Camera Settings**

After you load a user settings file, you can compare each camera’s current values to the file values, and then decide whether to apply the file values. You can apply values from the file to each camera individually.

You can also review and adjust the global values. For more information, see “**Configure and Save Global Settings**” on [page 108](#).

#### To review and apply camera settings:

1. Select the camera for which you want to review and apply setting values.
2. Review the settings for each axis.

The values shown are the current values. If a setting is orange, it means that the current value is different than the value specified by the user settings file. For more information, see “**Interpreting Joystick Settings Graphics**” on [page 113](#).
3. If you want to apply all the values from the user settings file, tap the **OPERATE** button.

The values are applied. For each setting, if the file contains an override value for that setting for the selected camera, that value is applied. Otherwise, the global value from the file is applied.
4. If you want to review and apply setting values for another camera, repeat 1 to 4.

If the values you applied are not exactly the way you’d like them, you can adjust the values and save them. For more information, see “**Configure and Save Override Settings for a Camera**” on [page 109](#).

#### **Copying Setting Values to Other Cameras**

You can copy setting values from one camera to others.

When you copy values, the selected camera’s current setting values are saved to a user settings file, as override values for one or more cameras and/or as global values.

If a user settings file is already loaded, the copied values are saved to that file. Otherwise, you can save them to an existing file or to a new file. After you copy values, the user settings file to which the values were saved is automatically loaded into the Joystick Control Settings interface.

Copying values does not automatically apply them. After you copy values, you can review and apply them to each of the affected cameras. For more information, see “**Review and Apply Camera Settings**” on [page 111](#).

### To copy settings to other cameras:

1. Select the camera from which you want to copy setting values (source camera).
2. Configure the settings.
3. Tap the **COPY TO DEVICES** button.  
The **SELECT DEVICES** dialog box appears.
4. Select the camera(s) for which you want SmartShell to update override values in a user settings file.  
**Note:** When you copy values, all applicable values from the source camera are copied. If a destination camera has axes that the source camera does not, any defined override values for those axes remain unchanged.  
**Tip:** If you want to save the copied values as override values for the source camera, ensure that the source camera is selected.
5. If you want to replace the file's global values with the source camera's current values, select **Global**.  
**Note:** If you include **Global**, the copied values automatically become the global values shown in the Joystick Control Settings interface. If any camera settings use global values, the interface indicates the difference between the camera's current values (old global values) and the file's global values. For more information about evaluating the differences, see "**Interpreting Joystick Settings Graphics**" on [page 113](#).
6. Tap **UPDATE**.  
If a user settings file is already loaded, the changes are saved to that file.
7. If the **Save user Settings File** dialog box appears, do the following:
  - a. Browse to the folder where you want to save the user settings file.
  - b. If you want to save changes to an existing file, select the file.
  - c. If you want to create a new file, in the **File name** box, type a name for the file.
  - d. Tap the **Save** button.
  - e. If the **Override UserSettings File** message appears, tap **YES**.

### *Saving the Currently-Selected Camera's Settings as Global Settings*

You can adjust and test joystick control setting values on a camera, and then save those values as global values in a user settings file.

When you save a camera's values as global values, only values for the axes available on that camera are saved. Global values for other axes remain unchanged. For example, if you use a pan/tilt head to configure global values, you cannot configure global values for the **TRACK** axis because the pan/tilt head does not have a TRACK axis. If you want to configure and save global values for all cameras in a new user settings file, see "**Configure Global Settings**" on [page 118](#).

### To save currently-selected camera settings as global settings:

1. Select the camera you want to use for configuring global values.
2. Configure all settings to values you want to use as global values.  
**Tip:** Settings include sliders for **SPEED**, **DAMPING**, and **ZOOMVAR**, as well as **INVERT** check boxes and **Pan Relative** check boxes. The variety of settings varies between axes.  
**Tip:** You can test the values. Change a value, then test the value by using the joystick panel to move the axis.  
For more information about types of settings, see "**Types of Joystick Control Settings**" on [page 103](#).
3. Save the current values as global values:
  - a. Tap the **SAVE DEVICE TO GLOBAL** button.
  - b. When the **CONFIRM SAVE** message appears, tap **YES**.  
The **Save User Settings File** dialog box appears.

If a user settings file is loaded, the file name appears in the **File name** box.

c. Do one of the following:

- If a user settings file is loaded and you want to update it with your changes, tap the **Save** button.
- If you want to save the changes in a new or different user settings file:
  - › Browse to the folder where you want to save the user settings file.
  - › If you want to save changes in an existing file, select the file.
  - › If you want to create a new file, in the **File name** box, type a name for the file.
  - › Tap the **Save** button.
  - › If the **Override UserSettings File** message appears, tap **YES**.

**Note:** If you saved the changes to a new or different file, that file is automatically loaded into the Joystick Control Settings interface.

The user settings file is saved.

**Note:** Saving global values does not automatically apply them to cameras. To apply saved global values, you must select a camera and then tap **OPERATE**.

## Interpreting Joystick Settings Graphics

This section describes how to interpret graphics that appear in the Joystick Control Settings interface.

At any given moment, the interface displays either global values, or values for a camera. Graphics vary somewhat between these two groups of settings. Identical graphics are interpreted differently depending on whether you are configuring global values or values for a camera.

A title near the top of the interface indicates whether it shows global values or values for a camera.

### **About Current Values and File Values**

Whenever this document says the current value of a setting matches the file's value, it means the current value matches one of the following, in order of precedence:

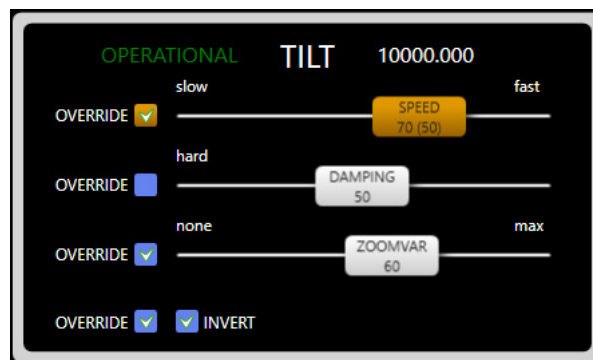
1. The file's override value for that setting, for that camera.
2. The file's global value for that setting, if the file does not contain an override value.

For more information, see "**Understanding Global Values and Override Values**" on [page 103](#).

### **Axis Panels**

An axis panel contains joystick control settings for the axis listed at the top of the panel.

The Joystick Control Settings interface shows an axis panel ([Figure 85](#)) for each axis you can configure.



**Figure 85** - An Axis Panel (TILT)

If you are configuring global settings, axis panels for all axes are shown.

If you are configuring settings for a camera, axis panels for only the available axes are shown. Different types of cameras have different axes. For example, a CamBot XY pedestal doesn't have a **TRACK** axis.

### Camera Settings: Interpreting Colors and OVERRIDE Check Boxes

This section applies only when you are configuring camera settings.

If a user settings file is loaded, settings are color-coded to indicate whether the current values match values specified by the file (file value):

- A white or blue setting indicates that the current value matches the file value. These colors are also present if no user settings file is loaded.
- An orange setting indicates that the current value does not match the file value. If a slider handle is orange, it shows the current value followed by the file value in brackets.

**The status and color of OVERRIDE check boxes indicates whether the current value is a global value:**

- **Clear and blue** — The current value is the global value, and the file does not contain an override value.
- **Clear and orange** — The current value is the global value. The file contains an override value.
- **Selected and blue** — The current value is an override value, and the file contains an override value. If the associated setting is not orange, the current value is the file's override value.
- **Selected and orange** — The current value is an override value, but the file does not contain an override value. If the associated setting is orange, the current value is different than the global value.

**Tip:** By specifying an override value that matches the global value, you can prevent the value from changing if the global value later changes.

For more information about global values and override values, see “[Understanding Global Values and Override Values](#)” on [page 103](#).

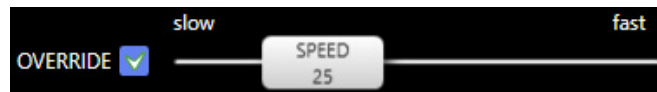
The following examples describe how to interpret camera settings:

1. In this example the **OVERRIDE** check box is blue and clear, and the slider handle is white.



Interpretation:

- The current value of **50** conforms to the file value (white slider handle)
  - The current value is the global value (**OVERRIDE** check box is clear and blue)
  - The file does not contain an override value (**OVERRIDE** check box is blue and clear, and slider handle is white)
2. In this example the **OVERRIDE** check box is blue and selected, and the slider handle is white.



Interpretation:

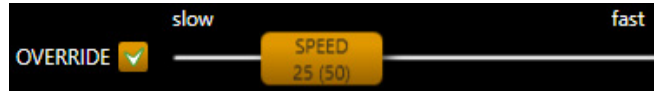
- The current value of **25** conforms to the file value (white slider handle)
  - The current value is not the global value (**OVERRIDE** check box is selected)
  - The file contains an override value (**OVERRIDE** check box is blue and selected)
3. In this example the **OVERRIDE** check box is blue and selected, and the slider handle is orange.



Interpretation:

- The current value of **40** does not conform to the file value of **25** (orange slider handle)
- The current value is not the global value (**OVERRIDE** check box is selected)
- The current value is an override value, but it is not the override value from the file (**OVERRIDE** check box is blue and selected, and slider handle is orange)

4. In this example the **OVERRIDE** check box is orange and selected, and the slider handle is orange.



Interpretation:

- The current value of **25** does not conform to the file value of **50** (orange slider handle)
- The current value is not the global value (**OVERRIDE** check box is selected)
- The file does not contain an override value, and the global value is **50** (**OVERRIDE** check box is orange and selected, and slider handle is orange and shows **50** in brackets)

5. In this example the **OVERRIDE** check box is orange and selected, and the slider handle is white.



Interpretation:

- The current value of **50** conforms to the file value of **50** (white slider handle)
- The current value is not the global value (**OVERRIDE** check box is selected)
- The file does not contain an override value (**OVERRIDE** check box is orange and selected)
- The current value happens to be the same as the file value, which is the global value, but it is an override value (**OVERRIDE** check box is orange and selected, slider handle is white).

**Tip:** By specifying an override value that matches the global value, you can prevent the value from changing if the global value later changes.

6. In this example the **OVERRIDE** check box is blue and clear, and the **INVERT** check box is blue and clear.



Interpretation:

- The current value of **INVERT (clear)** conforms to the file value (**INVERT** check box is blue)
- The current value of **INVERT (clear)** is the global value (**OVERRIDE** check box is clear and blue)

7. In this example the **OVERRIDE** check box is blue and selected, and the **INVERT** check box is blue and clear.



Interpretation:

- The current value of **INVERT (clear)** conforms to the file value (**INVERT** check box is blue)
- The current value of **INVERT (clear)** is an override value (**OVERRIDE** check box is selected)
- The file contains an override value (**clear**) for **INVERT**. The global value (**selected**) is overridden. (**OVERRIDE** check box is selected and blue, and the value of **INVERT** is **clear**)

8. In this example the **OVERRIDE** check box is orange and selected, and the **INVERT** check box is orange and **selected**.



Interpretation:

- The current value of **INVERT (selected)** does not conform to the file value (**INVERT** check box is orange)
  - The current value of **INVERT (selected)** is an override value (**OVERRIDE** check box is selected)
  - The file does not contain an override value (**OVERRIDE** check box is orange and selected)
  - The file does not contain an override value, and the global value is **clear** (**OVERRIDE** check box is orange and selected, and the **INVERT** check box is orange and **selected**)
9. In this example the **OVERRIDE** check box is blue and selected, and the **INVERT** check box is blue and **selected**.



Interpretation:

- The current value of **INVERT (selected)** conforms to the file value (**INVERT** check box is blue)
  - The current value of **INVERT (selected)** is an override value (**OVERRIDE** check box is selected)
  - The file does not contain an override value for **INVERT**. The global value (**clear**) is overridden. (**OVERRIDE** check box is selected and blue, and the value of **INVERT** is **selected**)
10. In this example the **OVERRIDE** check box is blue and selected, and the **INVERT** check box is orange and **clear**.



Interpretation:

- The current value of **INVERT (clear)** does not conform to the file value (**INVERT** check box is orange)
  - The current value of **INVERT (clear)** is an override value (**OVERRIDE** check box is selected)
  - The file contains an override value for **INVERT** (**OVERRIDE** check box is selected and blue)
  - The current value of **INVERT (clear)** happens to be the same as the global value, but it is an override value (**OVERRIDE** check box is blue and selected, **INVERT** check box is orange and **clear**).
- Tip:** By specifying an override value that matches the global value, you can prevent the value from changing if the global value later changes.

### **Global Settings: Interpreting Colors and OVERRIDE Check Boxes**

This section applies only when you are configuring global values.

If a user settings file is loaded, settings are color-coded to indicate whether the global values match global values from the file (file's global value):

- A white or blue setting indicates that the global value matches the file's global value. These colors are also present if no user settings file is loaded.
- An orange setting indicates that the global value does not match the file's global value. If a slider is orange, the slider handle shows the global value followed by the file's global value in brackets.

When you are configuring global values, **OVERRIDE** check boxes appear selected unless there is no global value defined. You cannot select or clear them. When configuring global values, ignore the **OVERRIDE** check boxes.

The following examples describe how to interpret global settings:

1. In this example the slider handle is white.



Interpretation:

- The current global value of **60** conforms to the file's global value (white slider handle)

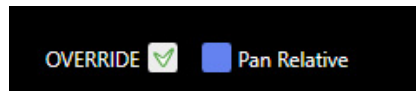
2. In this example the slider handle is orange.



Interpretation:

- The current global value of **75** does not conform to the file's global value of **50** (orange slider handle, showing **50** in brackets)

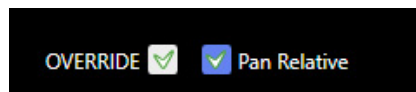
3. In this example the **Pan Relative** check box is blue and clear.



Interpretation:

- The current global value of **Pan Relative (clear)** conforms with the file value (**Pan Relative** check box is blue)

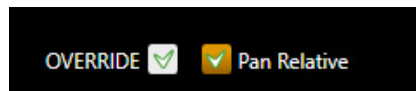
4. In this example the **Pan Relative** check box is blue and selected.



Interpretation:

- The current global value of **Pan Relative (selected)** conforms with the file value (**Pan Relative** check box is blue)

5. In this example the **Pan Relative** check box is orange and selected.



Interpretation:

- The current global value of **Pan Relative (selected)** does not conform with the file value (**Pan Relative** check box is orange)

6. In this example the **Pan Relative** check box is orange and clear.



Interpretation:

- The current global value of **Pan Relative (clear)** does not conform with the file value (**Pan Relative** check box is orange)

## Configuring Joystick Settings for an Entire Ross Robotics System

This section describes how to configure joystick control settings for all cameras, and how to save those settings in a user settings file.

Before you configure and save joystick control settings, ensure that all cameras are fully operational and connected to SmartShell.

The topics in this section are arranged in a specific order, designed to guide you through the process of configuring global settings and camera settings for your entire Ross Robotics system.

**The main steps are:**

1. Configure Global Settings (see “**Configure Global Settings**” on [page 118](#)).
2. Configure Individual Cameras (see “**Configure Individual Cameras**” on [page 119](#)).

### **Configure Global Settings**

In this workflow, we configure global settings by adjusting camera settings and then copying those settings (as global settings) to a new user settings file.

**This section includes two procedures:**

- “**Determine which cameras to use for configuring global settings:**” on [page 118](#)
- “**Configure and save global settings:**” on [page 118](#)

#### **Determine which cameras to use for configuring global settings:**

1. In SmartShell, open the Joystick Control Settings view.
2. Make a list of all cameras and the axes each camera has.  
**Tip:** To see what axes a camera has, select the camera and look at the axis panel titles.
3. Referring to the list you made in 2, make a list of each type of axis in your robotics system.
4. Including as few cameras as possible, identify a group of cameras that collectively have all axes. For example, if you have one Furio dolly, two Furio pan/tilt heads, and two CamBot XY pedestals, the group would include one Furio dolly and one CamBot XY pedestal. You would not include a Furio head because all its axes are also present on the Furio dolly. You will use this group of cameras to configure global values.

#### **Configure and save global settings:**

1. In the Joystick Control Settings view, tap the **NEW** button.
2. Select one of the cameras you identified for configuring global values.
3. Configure all settings to values you want to use as global values.  
**Tip:** Settings include sliders for **SPEED**, **DAMPING**, and **ZOOMVAR**, as well as **INVERT** check boxes and **Pan Relative** check boxes. The variety of settings varies between axes.  
**Tip:** You can test the values. Change a value, then test the value by using the joystick panel to move the axis.  
For more information about types of settings, see “**Types of Joystick Control Settings**” on [page 103](#).
4. On the list of axes you made in the previous procedure, cross out the ones you configured. The list now shows axes for which you have not yet configured global settings.
5. Save the settings:
  - a. Tap the **SAVE DEVICE TO GLOBAL** button.
  - b. When the **CONFIRM SAVE** message appears, tap **YES**.  
The **Save User Settings File** dialog box appears.

- c. In the **Save User Settings File** dialog box, browse to the folder where you want to save the user settings file.
- d. In the **File** name box, type a name for the file.
- e. Tap the **Save** button.

The user settings file is saved. It contains global settings only.

- 6. In the Joystick Control Settings interface, select another camera you identified for configuring global values.
- 7. Tap **OPERATE** to apply file settings.
- 8. Of the axes shown, identify the ones for which you have not yet configured global settings.  
**Tip:** Refer to the list of axes you made in the previous procedure.
- 9. Configure all settings for the axes you identified in 8.
- 10. On the list of axes you made in the previous procedure, cross out the ones you configured.
- 11. Repeat 6 to 10 until no axes remain on the list.

### **Configure Individual Cameras**

When you configure individual cameras, you specify how their joystick control setting values differ from the global values.

If you have multiple cameras you want to configure identically or similarly, note such groups.

#### **To Configure Individual Cameras:**

- 1. In the Joystick Control Settings view, select a camera.
- 2. Tap **OPERATE** to apply file settings to the camera.
- 3. For each setting that you want to configure differently than shown, change the value as required. As you adjust settings, **OVERRIDE** check boxes beside the settings are automatically selected.  
**Tip:** Settings include sliders for **SPEED**, **DAMPING**, and **ZOOMVAR**, as well as **INVERT** check boxes and **Pan Relative** check boxes. The variety of settings varies between axes.  
**Tip:** You can test the values. Change a value, then test the value by using the joystick panel to move the axis.  
**Tip:** If you want a setting to have the same value as the global value, but you do not want the value linked to the global value, select the **OVERRIDE** check box beside the setting. If the setting is orange, change the value to match the global value, as indicated by a white slider or blue check box. If the global value changes later, the setting value will remain unchanged from the original global value. For more information about types of settings, see "**Types of Joystick Control Settings**" on [page 103](#). Tap the **SAVE** button.
- 4. When the **CONFIRM SAVE** message appears, tap **YES**.  
The **Save User Settings File** dialog box appears.
- 5. Tap the **Save** button.  
The settings are saved.
- 6. If you want to configure other cameras identically or similarly to the currently-selected camera, do the following:
  - a. Tap the **COPY TO DEVICES** button.
  - b. The **SELECT DEVICES** dialog box appears.
  - c. Select the cameras you want to copy settings to, and then tap **UPDATE**.  
The settings are saved in the user settings file.
  - d. For each camera to which you copied settings:
    - If the settings are acceptable, select the camera and then tap **OPERATE** to apply the settings.

- If the settings require changes, repeat steps 1 to 5.
7. If there are cameras for which you have not yet configured joystick control settings, repeat steps 1 to 6.

# Axis Configuration

The **Axis Control** panel enables you to configure axis behavior for manual and joystick operation.

This section includes the following topics:

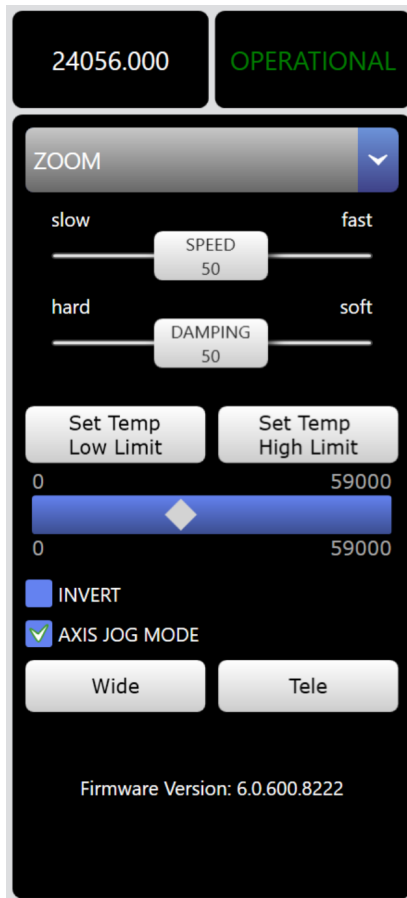
- “**Select an Axis to Configure**” on [page 111](#)
- “**View the Current Axis Position Value and Status**” on [page 112](#)
- “**Configure Camera Response to Manual Controls**” on [page 112](#)
- “**View and Set Temporary Axis Limits**” on [page 114](#)
- “**Handling Beyond Limits State on XY Axis**” on [page 121](#)
- “**Regain Control of the Camera**” on [page 120](#)
- “**Targeting XY Pedestals**” on [page 124](#)
- “**Overriding the Furio Collision Avoidance System**” on [page 126](#)

## Select an Axis to Configure

To select an axis:

- In the **Axis Control** panel ([Figure 78](#)), tap the **axis list** to expand it and then tap the axis you want to configure.

The **Axis Control** panel shows information for the selected axis.



*Figure 78 - Axis Control Panel*

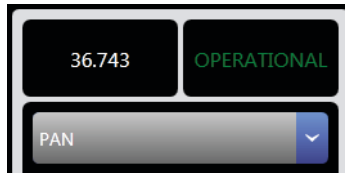
# View the Current Axis Position Value and Status

The **axis status area** (top portion) of the **Axis Control Panel** shows the current axis position value and the operational status of the axis.

**Tip:** The **axis bar** shows a graphic representation of the axis position. For more information, see “**View and Set Temporary Axis Limits**” on [page 114](#).

To view the current axis position value and status:

1. In the **Axis Control** panel, select an axis.
2. In the **axis status area** ([Figure 79](#)), view the axis position and the operational status.



**Figure 79** - Axis Status Area of the Axis Control Panel

The axis positions are shown in the following units:

- **XY** — The **X** and **Y** values express the absolute position of a CamBot XY pedestal on the studio floor, in millimeters from the XY origin [X=0, Y=0], which is located approximately at the center of the CamBot target. **X** is the distance right or left of the XY origin. **Y** is the distance forward or backward from the XY origin.

The **Θ** (theta) value is the angle the pedestal base faces, in degrees, relative to the XY origin. When the angle is **0** degrees, the pedestal base faces the same direction as the target (typically towards the set). The base can rotate approximately +/- 360°. Theta values increase as the pedestal base rotates counter clockwise, or decrease as it rotates clockwise.

- **Pan** — degrees
- **Tilt** — degrees
- **Zoom** — counts, which vary by the model of lens used
- **Focus** — counts, which vary by the model of lens used
- **Lift** — millimeters
- **Track** — millimeters

## Configure Camera Response to Manual Controls

You can configure how the selected camera responds to joystick movements and axis movement buttons in the **Axis Configuration** panel.

**You can:**

- Set the Maximum Axis Speed for Manual Operation (see [page 113](#))
- Set the Damping Ratio for Manual Operation (see [page 113](#))
- Set the Variable Zoom Ratio for Manual Operation (see [page 113](#))
- Invert the Direction of Axis Movement for Manual Operation (see [page 114](#))

If you are configuring an XY pedestal, you can also enable/disable pan-relative steering. For more information, see “**Standard Steering and Pan-Relative Steering for XY Pedestals**” on [page 143](#).

**Note:** Alternatively, you can configure these settings in the Joystick Control Settings view, which enables you to save settings in user settings files. For more information, see [“Joystick Control Settings” on page 101](#).

## Set the Maximum Axis Speed for Manual Operation

You can set the maximum speed for the selected axis when the camera is controlled manually. The value is a percentage of the configured maximum speed.

**To set the maximum speed:**

1. In the **Axis Control** panel, select an axis.
2. Drag the **SPEED** slider ([Figure 80](#)) to set the speed for the axis when controlled manually, as a percentage of the configured maximum axis speed.



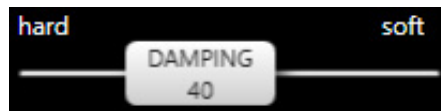
*Figure 80 - SPEED Slider*

## Set the Damping Ratio for Manual Operation

You can set the damping ratio to ensure smooth acceleration and deceleration when operating a camera manually, using the joystick panel or axis movement buttons.

**To set the damping ratio:**

1. In the **Axis Control** panel, select an axis.
2. Drag the **DAMPING** slider ([Figure 80](#)) to set the damping ratio for the axis when controlled manually, as a percentage of the configured maximum acceleration / deceleration rate.



*Figure 81 - DAMPING Slider*

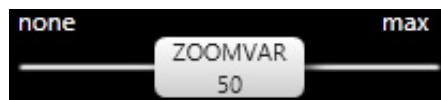
## Set the Variable Zoom Ratio for Manual Operation

Moving a camera at a given rate has a more drastic visual effect when the camera is zoomed in. The ZOOMVAR feature, which applies to manual control only, varies the speed of the affected axis with the value of the zoom axis to make the motion appear smoother. When the lens is zoomed in, the affected axis moves more slowly. When the lens is zoomed out, the affected axis moves more quickly.

The ZOOMVAR feature applies only to the pan and tilt axes.

**To change the degree of variability:**

1. In the **Axis Control** panel, select the axis for which you want to set the degree of variability.
2. Drag the **ZOOMVAR** slider ([Figure 82](#)) to adjust the degree to which the speed of the axis varies with the value of the zoom axis.



*Figure 82 - ZOOMVAR Slider*

## Invert the Direction of Axis Movement for Manual Operation

You can reverse the direction of the selected axis for more intuitive operation. For example, if you set up a camera and find that pushing the X-Y joystick to the right moves the camera to your left, you can invert the track axis so the direction of joystick movement corresponds to the movement of the camera.

**To invert an axis:**

1. In the **Axis Control** panel, select the axis you want to invert.
2. Select or clear the **INVERT** check box ([Figure 83](#)).



*Figure 83 - INVERT Check box*

## View and Set Temporary Axis Limits

You can limit the range of motion for each axis of a camera. Limits can help prevent Furio dollies from colliding, prevent the camera lens or teleprompter from hitting the head, and prevent operators from unintentionally pointing the camera toward areas that should not be shown on-air.

This section includes the following topics:

- “**About Limits**” on [page 114](#)
- “**About the Axis Bar and Limit Buttons**” on [page 115](#)
- “**Setting and Clearing Temporary Axis Limits**” on [page 117](#)

### About Limits

There are three types of axis limits; temporary limits, persistent limits, and studio limits:

- **Temporary limits** — These limits are set in the **Axis Control** panel. They remain in force until they are cleared or until the robotic head is restarted. They are not saved on the robotic head.

The range of motion defined by temporary limits is always within the range defined by persistent limits. Temporary limits are always equal to or more restrictive than persistent limits.

Each axis may have a temporary **High Limit** and/or a temporary **Low Limit**. If a given temporary limit is not set, persistent limits apply.

To set both temporary limits for an axis, you must set one limit, reposition the camera, and then set the other limit. Temporary axis limits can be set only while the axis is not moving.

Whenever a camera encounters a temporary axis limit, a notification appears in the **Notifications** panel at the bottom of the SmartShell window.

**Note:** Narrowing the temporary axis limits can adversely affect existing presets and moves. If you create a preset, and then later set axis limits to be more restrictive, the preset destination may be outside of one or more axis limits. You may need to update existing presets and moves. For more information, see “**How Temporary Axis Limits Affect Presets and Moves**” on [page 120](#).

- **Persistent limits** — These limits are saved on the robotic heads. These limits remain even if the robotic head is restarted. Persistent limits are set differently on different types of robotic heads:
  - › **Furio Heads, or CamBot XY pedestals running Furio firmware** — Persistent limits are set using the Furio web interface.
  - › **CamBot heads, or CamBot XY pedestals running CamBot firmware** — Persistent limits are first set as temporary limits in SmartShell and then must be saved to the CamBot head through the

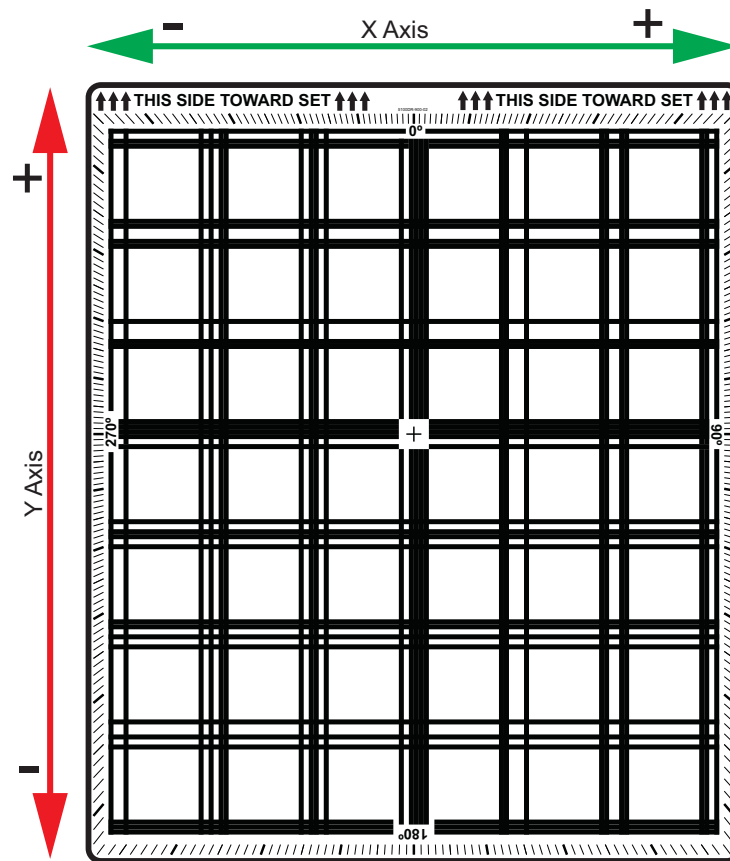
Robotics Server web interface. You can create persistent limits for the **PAN, TILT, and LIFT** axes only.

- **Studio limits** — In addition to temporary and persistent limits, the XY axis may be constrained by studio limits defined in a studio map. Studio maps are created in a separate tool (Studio Creator) and uploaded through the Furio web interface.

Studio maps define:

- › The boundary of an operating zone in which one or more XY pedestals will operate.
- › Fixed obstacles within that operating zone which the XY pedestals must avoid.

By default, the persistent limits for a CamBot XY pedestal are set at 60900 mm (200 feet) in each direction from the origin position  $[X=0, Y=0]$ . The origin position  $[X=0, Y=0]$  is approximately centered on the target. Each axis (X and Y) extends from the origin in two directions, counting positively and negatively, as shown in [Figure 84](#):



**Figure 84** - CamBot Target, Showing Orientation of X Axis and Y Axis

**IMPORTANT:** If a CamBot XY pedestal is not targeted, all axis limits for its XY axis are ignored. Pedestal movement for an untargeted XY pedestal is not restricted by any XY limits.

## About the Axis Bar and Limit Buttons

The axis bar ([Figure 85](#)) is a graphical representation of the axis. A diamond-shaped position marker on the axis bar indicates the current position of the selected axis.



**Figure 85** - The Axis Bar, with Position Marker indicating the Current Position of the Selected Axis

**Note:** The axis bar is hidden if the selected axis does not support it. This includes all axes of robots running older firmware, and the zoom, focus, and iris axes of CamBots running CamBot firmware.

If the position marker turns red, the camera has encountered a limit and further movement along the axis is not possible ([Figure 86](#)).



**Figure 86** - Encountering a Temporary High Limit (inaccessible area represented by gray zone)

Numbers below the axis bar represent the low and high persistent limit values.

Numbers above the axis bar represent the low and high effective limit values.

For most axes, temporary limits (if set) are the effective limits. If a given temporary limit is not set, the persistent limit is the effective limit. When a temporary limit is set, the end of the axis bar turns gray to represent the inaccessible portion of the axis. In [Figure 87](#), the temporary **Low Limit** is not set, so the persistent limit of **-178** is the effective low limit. The temporary **High Limit** is set to **106**, and is the effective high limit. Areas below **-178** or above **106** are not accessible.



**Figure 87** - The Axis Bar, with the Temporary High Limit Set

For the **TRACK** axis of a Furio dolly, the effective limit values may be persistent or temporary limits, or they may be limits imposed by a track reflector or the Furio collision avoidance system ([Figure 88](#)):



**Figure 88** - The Axis Bar for the **TRACK** Axis, showing a Collision Avoidance Limit (red value and bar) and a Reflector Limit (yellow value and bar). The Reflector Limit is shown only while the dolly is at the limit or is beyond the limit (which can occur if the dolly approaches the reflector at high speed).

- If one end of the axis bar and that end's effective limit value are red, it is because the Furio collision avoidance system is restricting dolly travel toward that end of the track, based on the position of a neighboring dolly. The red portion of the axis bar represents the restricted zone.

The extent of the restricted zone changes as the other dolly moves along the track. To access more of the track, move the other dolly farther away.

**Note:** The Furio collision avoidance system is an optional accessory.

- If one end of the axis bar and that end's effective limit value are yellow, it is because a track reflector limit is preventing dolly travel toward that end of the track. The yellow portion of the axis bar represents the restricted zone.

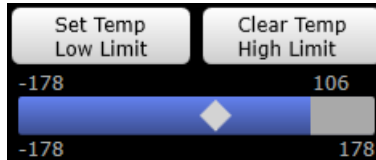
Normally, the limit imposed by a track reflector is not shown, because the system is unaware of the reflector until the dolly encounters it.

When a dolly encounters a reflector, the effective limit value and the portion of the axis bar beyond the reflector limit turn yellow. They stay yellow until the dolly is no longer at or beyond the reflector limit. When the dolly leaves the restricted zone, the effective limit value and the axis bar change to represent whatever limit is closest to the dolly. This could be a limit imposed by the Furio collision avoidance system, a temporary limit, or the persistent limit.

Measurement units represented by the numbers above and below the axis bar vary by axis:

- **Pan, Tilt** — degrees
- **Lift, Track**— millimeters
- **Iris, Zoom, Focus** — raw data values, also known as lens counts
- **XY** — millimeters from the origin [X=0, Y=0], which is located approximately at the center of the CamBot target.

Limit buttons above the axis bar enable you to set and clear temporary axis limits. For each axis, there is a **Low Limit** button and a **High Limit** button ([Figure 89](#)).

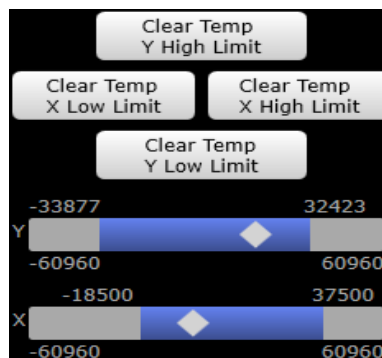


**Figure 89** - Axis Bar and Limit Buttons, with a High Temporary Limit Set

The function of each limit button changes depending on whether a limit is currently set:

- If a given temporary limit is not set, the top part of its limit button is labeled **Set Temp**. If you tap a **Set Temp** button, the current axis position is set as the temporary limit, and the button becomes a **Clear Temp** button.
- If a given temporary limit is set, the top part of its limit button is labeled **Clear Temp**. If you tap a **Clear Temp** button, the temporary limit is removed, and the button becomes a **Set Temp** button.

For the **XY** axis of a CamBot XY pedestal, two axis bars and four limit buttons are shown ([Figure 90](#)). There are separate axis bars for the **X** axis and the **Y** axis. The top and bottom limit buttons are for the **Y** axis, and the right and left limit buttons are for the **X** axis.



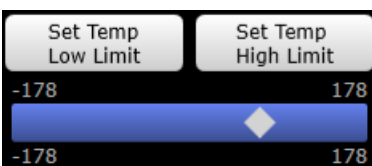
**Figure 90** - Axis Bars and Axis Limit Buttons for the XY Axis of a CamBot XY Pedestal

## Setting and Clearing Temporary Axis Limits

You can use the limit buttons to set low and high temporary axis limits, and to clear them.

### To set axis limits:

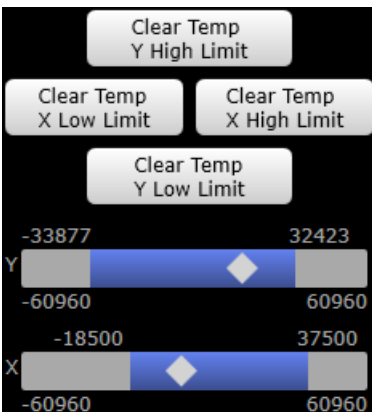
1. From the **Axis List** in the on the **Axis Control** panel, select an axis for which you want to set a limit. For most axes, one axis bar and two limit buttons (**Low Limit** and **High Limit**) appear ([Figure 91](#)).



**Figure 91** - Axis Bar and Limit Buttons

If no temporary limits are set, the top part of each limit button is labeled **Set Temp**. If a given temporary limit is set, the top part of its limit button is labeled **Clear Temp**.

If the axis is an **XY** axis (CamBot XY pedestals only), two axis bars and four limit buttons appear (Figure 92). There are separate axis bars for the **X** axis and the **Y** axis. The top and bottom limit buttons are for the **Y** axis, and the right and left limit buttons are for the **X** axis.



**Figure 92** - Axis Bars and Axis Limit Buttons for the XY Axis of a CamBot XY Pedestal

For the **XY** axis (CamBot XY pedestals only), if the **Set Temp** limit buttons are shown but are not available (grayed out), it may be because of one of the following:

- The pedestal is not targeted. You cannot set temporary **XY** axis limits for a non-targeted pedestal. For more information, see “**Targeting XY Pedestals**” on [page 124](#).
- The pedestal is too close to the target. The **Low Limit** for each axis must be below **-457.2**, and the **High Limit** must be above **457.2**.

**2.** Move the camera axis to the position you want to set as a limit.

You can use the joystick panel, or manually position the camera in SmartShell. For more information, see “**Operate a Camera Manually (Axis Jog Mode)**” on [page 140](#).

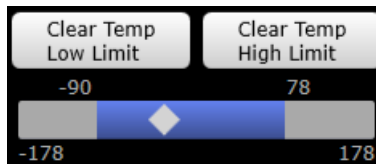
**Tip:** If you cannot move the axis to the desired position, look at the axis bar. If the position marker is at the end of the available range (blue portion of the axis bar), the robot has encountered an effective limit:

- If the bar beyond the position marker is gray, movement is blocked by a temporary limit. Tap the **Clear Temp** button for the limit, and then continue moving the axis.
- If the axis is the **Track** axis of a Furio dolly and the bar beyond the position marker is yellow, the dolly has encountered a reflector limit.
- If the axis is the **Track** axis of a Furio dolly and the bar beyond the position marker is red, the dolly has encountered a limit imposed by the collision avoidance system due to the close proximity of another dolly. Move the other dolly farther away, and then continue moving the dolly for which you want to set a track limit.

**Note:** For the **PAN** and **TILT** axes of CamBot heads, the minimum limit must be below **0**, and the maximum limit must be above **0**.

**3.** Tap the limit button for the limit you want to set (**Set Temp Low Limit** or **Set Temp High Limit**).

The current axis position is set as the temporary limit, and the button becomes a **Clear Temp** button. The portion of the axis bar beyond the limit turns gray (Figure 93).



**Figure 93** - - Axis Bar and Limit Buttons, with Low (-90) and High (78) Temporary Limits Set

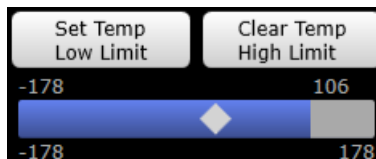
**Tip:** Whenever you set or clear a temporary limit, a notification appears in the **Notifications** panel at the bottom of the SmartShell window.

4. Repeat **Steps 1 to 3** for each limit (**Low Limit** and **High Limit**) for each axis as required.
5. If the robot is a CamBot head or a CamBot XY pedestal running CamBot firmware, and you want to save the **PAN, TILT, LIFT,** and **XY** limits as persistent limits, set the temporary limits for these axes and then do the following:
  - a. In a web browser, navigate to the **Robotics Server Host** page on the Robotics Server. Use the IP address for the Robotics Server, port 3000:  
**http://RoboticsServerIP:3000**
  - b. On the **Robotics Server Host** page, tap **Robotics Server**.
  - c. Tap the tab corresponding to the camera for which you want to save limits (**Camera 1, Camera 2,** etc.).
  - d. In the **Make temporary limits persistent as displayed above** box, tap **Apply**.

**Tip:** If you want to revert to the default persistent limits, in the **Clear all persistent limits to default (OPEN)** box, tap **Apply**, and then restart the robot.

**To clear axis limits:**

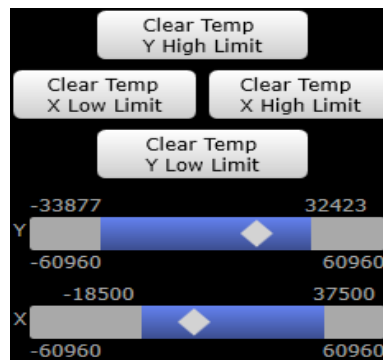
1. From the **Axis List** in the on the **Axis Control** panel, select an axis for which you want to clear one or more axis limits.  
For most axes, one axis bar and two limit buttons (**Low Limit** and **High Limit**) appear ([Figure 94](#)).



**Figure 94** - Axis Bar and Limit Buttons

If no temporary limits are set, the top part of each limit button is labeled **Set Temp**. If a given temporary limit is set, the top part of its limit button is labeled **Clear Temp**.

If the axis is an **XY** axis (CamBot XY pedestals only), two axis bars and four limit buttons appear ([Figure 95](#)). There are separate axis bars for the **X** axis and the **Y** axis. The top and bottom limit buttons are for the **Y** axis, and the right and left limit buttons are for the **X** axis.



**Figure 95** - Axis Bars and Axis Limit Buttons for the XY Axis of a CamBot XY Pedestal

2. If you want to clear a low temporary limit, tap the **Clear Temp Low Limit** button.
3. If you want to clear a high temporary limit, tap the **Clear Temp High Limit** button.

**Tip:** Whenever you clear or set a temporary limit, a notification appears in the **Notifications** panel at the bottom of the SmartShell window.

#### For More Information About...

- repositioning the camera in SmartShell, see “**Manual Operation in SmartShell**” on [page 139](#)
- repositioning the camera using the joystick panel, see “**The Joystick Panel**” on [page 90](#)

## How Temporary Axis Limits Affect Presets and Moves

It is possible for a preset to have a destination that is beyond temporary axis limits. If you create a preset, and then later set temporary axis limits to be more restrictive, the preset destination may be outside of one or more temporary axis limits.

As the preset runs, the robot may reach one or more temporary axis limits. How the robot behaves depends on whether it is a CamBot or a Furio.

**Note:** Within the context of this subject, CamBot pedestals running Furio firmware are considered to be Furiors.

- If the robot is a CamBot, the system scales the rate of motion to match the duration of the preset. For example, if the preset requires the lift column to rise by 50 cm over 5 seconds, but the lift axis limit allows it to rise only 30 cm, the lift column rises 30 cm over 5 seconds.
- If the robot is a Furio, the affected axis moves at the rate required to satisfy the preset as defined. The axis stops smoothly when the temporary axis limit is encountered. Other axes continue to move until the preset duration is complete. For example, if a preset requires a Furio dolly to move 5 m in 10 seconds, but a temporary track axis limit allows it to travel only 2m, the dolly travels at the rate required to span the full 5m in ten seconds, but stops smoothly at the 2m limit. The other axes continue to move as required.

If a preset that exceeds a temporary axis limit is a keyframe in a move, and a later keyframe returns the axis to within its limits, the axis moves towards the destination after a delay. The delay is caused by the fact that when the keyframe starts, the requested position on the affected axis is beyond the temporary axis limits. The keyframe catches up to the robot's position on the axis, and then the axis starts moving.

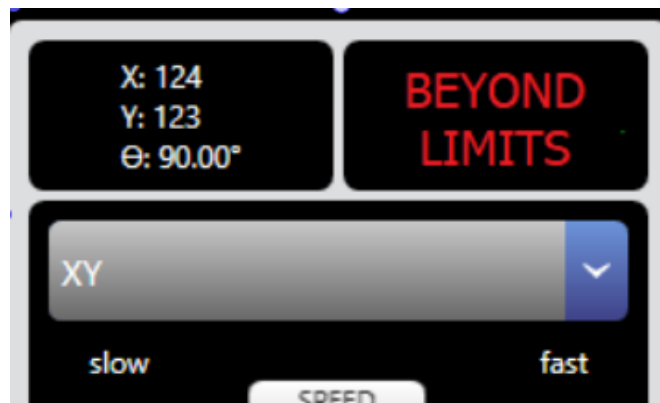
**Note:** If a Furio dolly encounters a track limit reflector, it abruptly stops moving along the track. Other axes continue to move as required. The stop is not smooth because the reflector is not anticipated. Reflectors are intended as a back-up safety measure, and should not be relied upon as track limits.

# Handling Beyond Limits State on XY Axis

The **BEYOND LIMITS** feature manages the behavior of robotic pedestals when they exceed the defined boundaries or within obstacle zones. This can occur if the pedestals are driven there in local control mode, or if a new map is loaded which places the pedestal's current position beyond its limits.

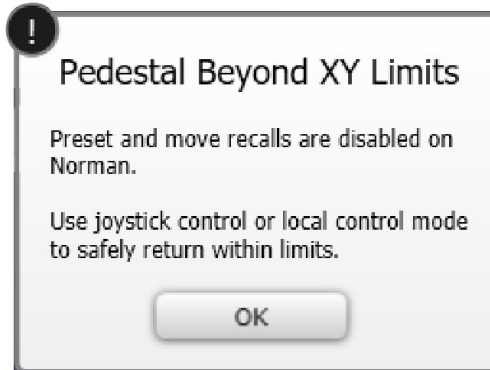
When a pedestal is in the **BEYOND LIMITS** state, joystick motion becomes restricted to prevent movement away from the operating zone. Additionally, presets and moves are disabled to ensure safety and prevent potential damage.

The XY axis status will display **BEYOND LIMITS** in red to provide a clear visual indication of the pedestal's state ([Figure 96](#)).



*Figure 96 - BEYOND LIMITS status*

**Note:** The **Pedestal Beyond XY Limits** warning prompts ([Figure 97](#)).



*Figure 97 - Pedestal Beyond XY Limits*

**To recover from going beyond XY axis limits:**

1. Use the joystick to maneuver the pedestal back within operational limits.
2. Observe the status indicator on the XY axis to confirm when the pedestal is back within limits.

**For More Information About...**

- Repositioning the camera in SmartShell, see "**Manual Operation in SmartShell**" on [page 139](#)
- Repositioning the camera using the joystick panel, see "**The Joystick Panel**" on [page 90](#)

# Joystick Control Confirmation

Depending on your system's configuration, taking joystick control of a robot that another client already has control of may prompt a dialog box to confirm or cancel the control takeover. This workflow also includes the ability to bypass the confirmation dialog.

## Confirming Joystick Takeover

It is possible for SmartShell stations to participate in confirming joystick control takeover from other clients. When enabled, any attempts to take joystick control of a robot when another client already has control requires confirmation or cancellation of the takeover operation.

**Note:** As part of this system, SmartShell stations can be given a name which robots will use to identify the station when a different client tries to take joystick control. This name is used to identify when another station attempts to take over and is also displayed in the SmartShell title window bar.

## Skipping Control Confirmation

In addition, it is possible to 'skip' the **Confirm Control**. Depending on your system configuration, it may be optional to **Skip** confirming a joystick control takeover and instead instantly take control.

For the **Legacy Joystick Panel**, skipping **Confirm Control** can be achieved by:

- Holding **Shift** or **Alt** and pressing **Operate**.
- Holding **Alt** on the joystick panel and selecting the desired robot with the selection buttons if the joystick camera selection is configured to take joystick control.

For the **CX-3R Joystick Panel**, skipping **Confirm Control** can be achieved by:

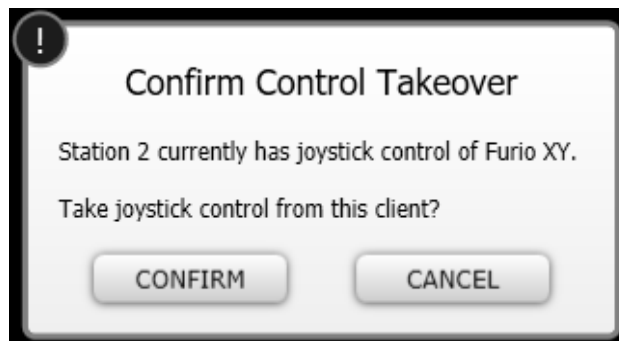
- Press **Force Operate** to toggle on, then press the **Operate** button, or the desired robot on the selection buttons if the joystick camera selection is configured to take joystick control.

**Note:** Once the selection has occurred the **Force Operate** button will untoggle itself.

## Taking Control of One Camera

To regain control of a camera:

1. In the **Camera Selection** panel, tap the camera you want to control.
2. In the **Axis Control** panel, tap the **OPERATE** button.
3. In the **Confirm Control Takeover** dialog box, tap **Operate** ([Figure 98](#)).



**Figure 98** - Confirm Control Takeover dialog box

**Note:** This dialog will only appear if another client already has joystick control and joystick control takeover is configured for your system.

## Taking Control of Multiple Cameras

You can take control of individual cameras, or all cameras.

### To take control of all cameras:

1. At the bottom of the SmartShell application, tap the **OPERATE ALL** button.
2. In the **Operate All** dialog box, tap **Operate All** ([Figure 99](#)).



**Figure 99** - OPERATE ALL - Confirm Joystick Control Takeover dialog box

**Note:** This dialog will only appear if another client already has joystick control and joystick control takeover is configured for your system.

# Targeting XY Pedestals

Before you can create or recall presets for an XY pedestal, the pedestal must be targeted.

Targeting a pedestal enables it to determine where it is on the studio floor, and what direction it is facing.

You must target pedestals each time you turn them on. To ensure continued accuracy, it is also good practice to target pedestals regularly. Some broadcasters target pedestals once per day, or before each show. Others prefer to target less frequently, or only when decreased accuracy is detected.

**Note:** If you use local control on a Vinten XY pedestal, you must target the pedestal after you finish using local control.

**IMPORTANT:** If the pedestal is not targeted, axis limits for the XY axis are ignored. Pedestal movement is not restricted to the area defined by the XY limits.

## Targeting CamBot XY Pedestals

When you target a CamBot XY pedestal, the pedestal determines its location on the studio floor by observing markings on a target sheet.

The edges of the target sheet have degree markings. Typically, the edge showing **0°** points towards the set, the **90°** edge points to camera right (stage left), the **180°** edge points away from the set, and the **270°** edge points to camera left (stage right). This orientation is optimal for standard steering, in which the direction of pedestal motion is relative to the target orientation. For more information, see “**Standard Steering and Pan-Relative Steering for XY Pedestals**” on [page 143](#).

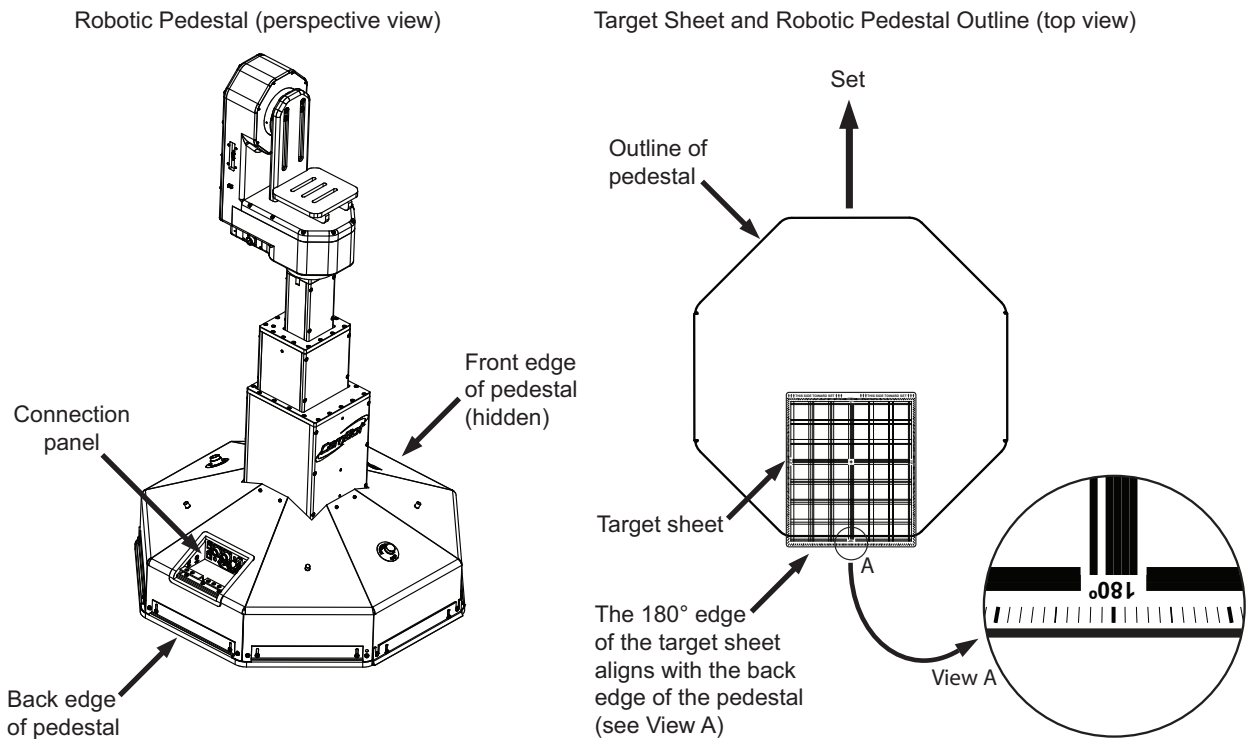
For more information about installing the CamBot XY target, see the document, ***Installing a CamBot Target (5100DR-818-xx)***.

**To target a CamBot XY pedestal:**

1. If the pedestal is not already running, turn it on.  
The pedestal takes approximately one minute to initialize.
2. In SmartShell, select the CamBot XY pedestal camera and take control of it.  
For more information, see “**Selecting a Camera System to Control**” on [page 22](#).
3. Do one of the following to move the pedestal into the target position:
  - If you are re-targeting a pedestal that has not been turned off since targeting, and there is a preset based on the target position, recall that preset.
  - Use the joystick panel to position the pedestal over the target sheet such that the back edge of the pedestal (connection panel) is aligned with the **180°** edge of the target sheet ([Figure 100](#)).
  - Use the local control box to position the pedestal over the target sheet such that the back edge of the pedestal is aligned with the **180°** edge of the target sheet ([Figure 100](#)). Ensure the control switch is set to **REMOTE** before you continue.

**Note:** The local control box is an optional accessory. For more information, see “**CamBot Local Control Box**” on [page 134](#).

**Note:** The pedestal does not need to align perfectly with the target sheet. Many operators find it useful to position the pedestal such that the target sheet extends approximately 25 mm (one inch) beyond the back edge of the pedestal.



**Figure 100** - Positioning a Robotic Pedestal Over the Target Sheet

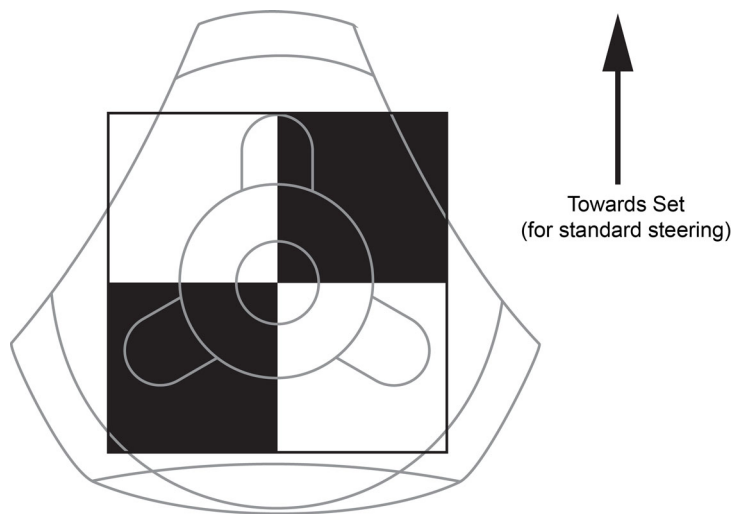
4. In SmartShell, on the **Axis Control** panel, select the **XY** axis from the axis list.
5. Tap the **TARGET** button.  
The pedestal is targeted.

**Tip:** The first time you target each CamBot XY pedestal, create a preset at that position. When creating the preset, select the **Auto Rotate Pedestal** option. Any time you want to target the pedestal, you can recall the preset to properly position the pedestal over the target sheet. You can also recall the preset to park the pedestal between shows, to make targeting before the next show easier.

## Targeting Vinten SP2000 XY Pedestals

When you target a Vinten SP2000 pedestal, the pedestal determines its location on the studio floor by observing markings on a target sheet.

Typically, the target is installed square to the set, oriented as shown in [Figure 101](#). This orientation is optimal for standard steering, in which the direction of pedestal motion is relative to the target orientation. For more information, see “**Standard Steering and Pan-Relative Steering for XY Pedestals**” on [page 143](#).



**Figure 101** - Positioning a Vinten SP2000 Pedestal Over its Target

**To target a Vinten SP2000 pedestal:**

1. If the pedestal is not already running, turn it on.  
The pedestal takes approximately one minute to initialize.
2. In SmartShell, select the pedestal camera and take control of it.  
For more information, see “**Selecting a Camera System to Control**” on [page 22](#).
3. Use the joystick panel to position the pedestal over the target sheet as shown in [Figure 101](#).
4. In SmartShell, on the **Axis Control** panel, select the **XY** axis from the axis list.
5. Tap the **TARGET** button.

The pedestal moves while targeting, and then stops when targeting is complete.

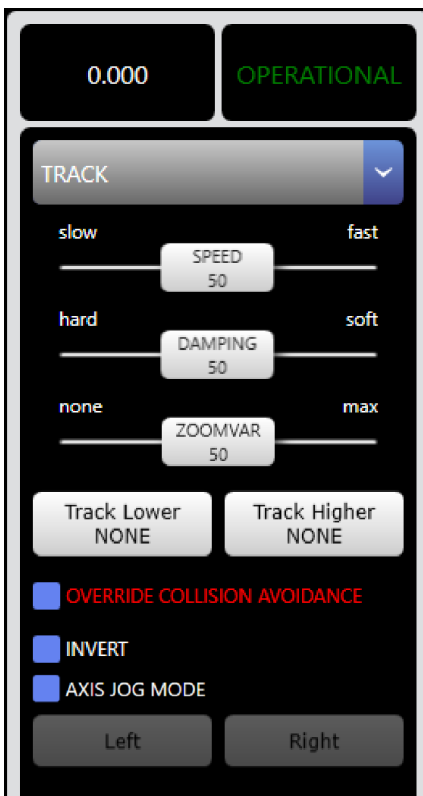
**Tip:** The first time you target each Vinten XY pedestal, create a preset at that position. Anytime you want to target the pedestal, you can recall the preset to quickly move the pedestal to the target sheet. You must rotate the pedestal to the orientation shown in [Figure 101](#) before targeting it. You can also recall the preset to park the pedestal between shows, to make targeting before the next show easier.

## Overriding the Furio Collision Avoidance System

The Furio Collision Avoidance System is an optional accessory that prevents multiple Furio robotic dollies on a single track from colliding. The system enables the dollies to exchange data about their positions. The dollies are configured to slow down and/or stop moving if they are in danger of colliding.

If a dolly fails, SmartShell allows you to override the collision avoidance system so you can continue using other dollies.

If one dolly is unable to receive position data from another dolly, track motion may become severely limited, causing the **OVERRIDE COLLISION AVOIDANCE** check box to appear on the Axis Control panel ([Figure 102](#)).



**Figure 102** - Axis Control Panel, showing Track Axis Settings including the Override Collision Avoidance Check Box

When the problem is resolved and all dollies are able to exchange position data, the collision avoidance system resumes normal operation and the override check box disappears.

**IMPORTANT:** After you override the collision avoidance system, dollies are not protected from colliding! Whenever the collision avoidance system is not operating, take the following precautions to help prevent collisions:

- Move inoperable dollies out of the path of working dollies.
- Install track reflectors at appropriate locations.
- Set appropriate temporary track limits.
- Do not move dollies along the track unless you have a clear view of the track. Watch the dollies as they move, and be prepared to tap the **STOP ALL** button in SmartShell.

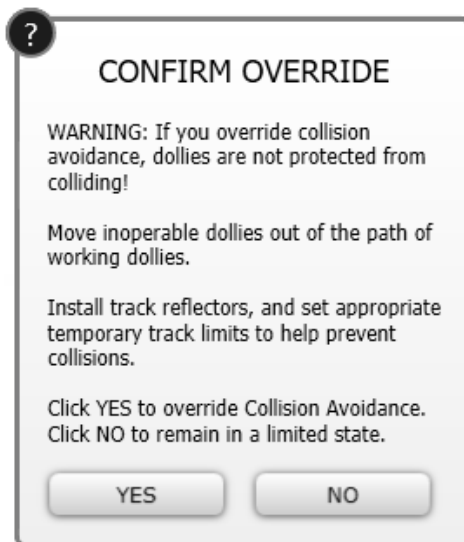
**To override the collision avoidance system:**

1. If the selected dolly fails to move along the track, look at the SmartShell **Axis Control Panel** to see if the **OVERRIDE COLLISION AVOIDANCE** check box is present ([Figure 103](#)).



**Figure 103** - The **OVERRIDE COLLISION AVOIDANCE** Check Box

2. If you want to override the collision avoidance system to regain control of the track axis, select the **OVERRIDE COLLISION AVOIDANCE** check box. The **CONFIRM OVERRIDE** dialog box appears ([Figure 104](#)).



**Figure 104** - CONFIRM OVERRIDE Dialog Box

3. If you want to override the collision avoidance system, tap **YES**.  
The collision avoidance system is disabled, and dollies are not protected from colliding.  
The collision avoidance system will resume operation when all dollies are able to receive position data from all other dollies.
4. Repeat this procedure for all other operational dollies, if you want to be able to move them along the track.

# Manual Operation in SmartShell

You can manually operate a camera using the **Axis Control** panel in the SmartShell interface. You can control one axis at a time. Manual operation in SmartShell is usually used for repositioning a camera for a preset, or for setting up a one-time shot. It is not normally used while the camera feed is going live to air.

Additionally, you can use the **Quick Focus** feature to fine-tune the focus of the selected camera without affecting other axes.

**This chapter contains the following sections:**

- “**Control Precedence**” on [page 139](#)
- “**Operate a Camera Manually (Axis Jog Mode)**” on [page 140](#)
- “**Using Quick Focus to Fine-Tune the Focus**” on [page 141](#)
- “**Aligning, Trucking, and Dollying XY Pedestals**” on [page 142](#)
- “**Standard Steering and Pan-Relative Steering for XY Pedestals**” on [page 143](#)

Alternatively, you can operate cameras manually using one of the following:

- The joystick panel  
For more information, see “**The Joystick Panel**” on [page 90](#).
- The Local Control Box (CamBot XY pedestals only)  
For more information, see “**CamBot Local Control Box**” on [page 134](#).

**IMPORTANT:** Manual control using SmartShell (Axis Jog Mode) is not recommended for on-air shots.

**Tip:** If your system includes tally integration, on-air status is indicated by a red dot in the **Camera Selection** panel.

## Control Precedence

Robots can be controlled by recalling shots and moves, or by joystick control or using buttons in the **Axis Control** panel. This section describes which control inputs take precedence.

**Control precedence for CamBot robots running CamBot firmware, and Vinten robots, is as follows:**

- While a preset recall is in progress, all axes remain available for joystick control, except the XY axis on XY pedestals.
- If the system receives a preset recall request while it is still processing joystick control input from the operator, the request fails and a message appears. It is important to note that the system continues to process joystick control input during robot deceleration, after the operator has released the joystick or **Axis Control** buttons.

**Control precedence for Furio robots, and CamBot XY pedestals running Furio firmware, is as follows:**

- For all robots running Furio firmware version 5.0 (or higher) — While the recall of a move or preset is in progress, all axes remain available for joystick control, except the XY axis of CamBot XY pedestals.
- For Furio robots running firmware version 4.x — If a preset recall or move is in progress, joystick control of each affected axis is unavailable until all automated movement of that axis is complete. Control of axes is individualized, so when automated movement of an axis is complete, the axis becomes available for joystick control even if the preset or move is still running.
- For Furio robots only — If the system receives a preset recall or move request while it is still processing joystick control input from the operator, the request fails and a message appears. It is important to

note that the system continues to process joystick control input during robot deceleration, after the operator has released the joystick or **Axis Control** buttons.

## Operate a Camera Manually (Axis Jog Mode)

To operate a camera manually using SmartShell:

1. In the **Camera Selection** panel, tap the camera you want to operate.
2. If the **OPERATE** button appears, tap it.
3. In the **Axis Control** panel, select the **AXIS JOG MODE** check box.  
While **Axis Jog Mode** mode is enabled, the camera is operated through the **Axis Control** panel and cannot be operated using the joystick panel.
4. In the **axis list**, tap the axis you want to operate.  
This is now the active axis.
5. Move the camera along the active axis:
  - If you are using a touch screen, touch and hold one of the axis movement buttons.
  - If you are using a mouse, click and hold one of the axis movement buttons.

Each axis movement button represents a direction along the axis. Axes can be controlled as follows:

- › **PAN axis** - **Left** and **Right** movement of the head
- › **TILT axis** - **Up** and **Down** movement of the head
- › **LIFT axis** - **Up** and **Down** movement. Applies only to Furio robots that include lift columns.
- › **ZOOM axis** - **Tele** and **Wide** movement of the lens
- › **FOCUS axis** - **Near** and **Far** movement of the lens
- › **TRACK axis** - **Left** and **Right** movement along the track. Applies only to Furio track-mounted dollies.
- › **XY axis** - Moves the pedestal along the studio floor. Applies only to XY pedestals. Movement buttons include **Forward**, **Turn Left**, **Turn Right**, and **Backward**.

When operating the XY axis, **Axis Jog Mode** buttons behave differently than the joystick panel. When controlling the joystick, **Forward** and **Backward** motion is relative to the pedestal base, not to the target or to the pan position. The side of the pedestal where the cables connect is the back. When you **Turn Right** or **Turn Left**, the shot is not affected. The pedestal base rotates, but the pan position is maintained.

The **Axis Control** panel also includes buttons that align the pedestal wheels parallel or perpendicular relative to either the pan position of the head or to the CamBot target orientation. For more information, see "**Aligning, Trucking, and Dollying XY Pedestals**" on [page 142](#).

**IMPORTANT:** If the pedestal is not targeted, axis limits for the XY axis are ignored. Pedestal movement is not restricted to the area defined by the XY limits.

**Tip:** To reverse the action of the axis movement buttons for the selected axis, select or clear the **INVERT** check box. This also reverses the effect of joystick panel controls for the axis.

6. Repeat **4** and **5** to operate other axes.
7. When finished, disable manual control of the camera by clearing the **AAXIS JOG MODE** check box.

# Using Quick Focus to Fine-Tune the Focus

You can fine-tune the focus of the selected camera without affecting other axes of motion.

The **Quick Focus** feature enables you to zoom the lens in fully, focus perfectly on an object of your choice, and then zoom out without affecting other axes of motion. Zooming in to focus enables you to focus more precisely.

You can use the **Quick Focus** feature to accomplish any of the following:

- Adjust focus on a one-time basis.
- Add a new preset based on the current camera position, including the adjusted focus setting.
- Update the focus setting for the most recently-selected preset.

## Notes:

- Depending on how your system is configured, the **Quick Focus** feature may not be available, or the ability to update the focus setting for the most recently-selected preset may not be available.
- If your system includes tally integration, and depending on how your system is configured, **Quick Focus** may be available only when the selected camera is off-air. This prevents the possibility of accidentally zooming and focusing while on-air.
- If your system does not include tally integration, ensure that the camera you want to focus is not on-air while you focus. Focusing typically takes less than 20 seconds.
- If the camera is a CamBot XY pedestal, the pedestal must be targeted before you can use the **Quick Focus** feature. For more information, see “**Targeting XY Pedestals**” on [page 124](#).
- The **Quick Focus** feature is not available for Vinten robots.

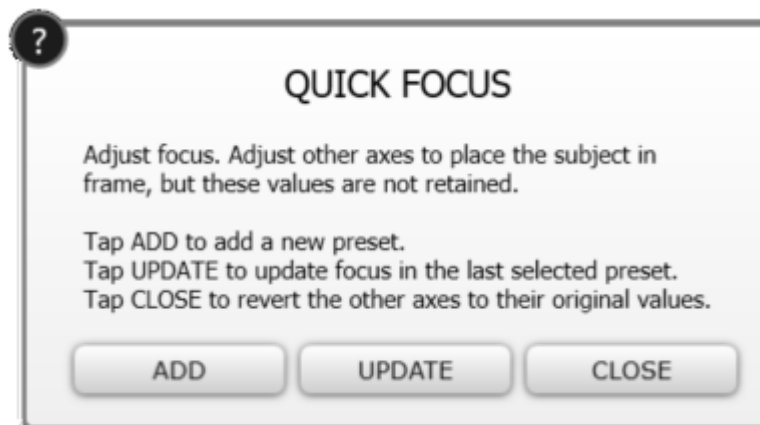
## To focus using the Quick Focus feature:

1. Select the camera you want to focus.
2. Do one of the following to initiate the **Quick Focus** feature:
  - On the **Legacy Joystick Panel**, press the **FOCUS** knob.
  - On the **CX-3R Joystick Panel**, press the **Focus** button.
  - In SmartShell, tap the **FOCUS** button.



**Tip:** The **FOCUS** button is available in the **Presets** panel and in the **Matrix view**. If the **FOCUS** button is not visible, the **Quick Focus** feature is not available.

The **QUICK FOCUS** dialog box appears ([Figure 113](#)), and the camera view zooms in fully.



*Figure 113 - QUICK FOCUS*

3. If the object upon which you want to focus is not in view, use the joystick panel or the **Axis Control** panel in SmartShell to move the camera so the object is visible. Doing so does not affect the preset position.
4. Do one of the following to adjust focus:
  - On the joystick panel, turn the **FOCUS** knob.
  - In SmartShell, in the **Axis Control** panel, enable **AXIS JOG MODE**, select the **FOCUS** axis and then adjust it using the **Focus Near** and **Focus Far** buttons.
5. If you want to create a new preset based on the original camera position and the current focus setting, tap the **ADD** button and then, if the **ADD PRESET** dialog box appears, specify settings for the new preset.  
 The **QUICK FOCUS** dialog box closes and the camera returns to its original position, retaining the new focus setting.  
 The **ADD PRESET** dialog box appears. For information about specifying preset settings, see “**Add a Preset**” on [page 29](#).
6. If you want to update the most recently-selected preset with the current focus setting, tap the **UPDATE** button and then tap **YES** to confirm the update.  
**Notes:**
  - If the **UPDATE** button is not visible, the option to update the preset is not available.
  - If the **UPDATE** button is visible but is not available, either no preset has been recalled, or a move has been recalled since the last preset was recalled.
7. If the **QUICK FOCUS** dialog box is still open, do one of the following to close it and to return the camera to its original position, retaining the new focus setting:
  - On the joystick panel, press the **FOCUS** knob.
  - In SmartShell, in the **QUICK FOCUS** dialog box, tap **CLOSE**.

## Aligning, Trucking, and Dollying XY Pedestals

When you truck a camera pedestal, you move it right or left relative to the subject. When you dolly a camera pedestal, you move it toward or away from the subject.

Before you can truck or dolly the pedestal, you must align the wheels so the pedestal is ready to move in the desired direction.

This section contains steps to align the pedestal, and to dolly or truck the camera.

### To align the pedestal:

1. In SmartShell, select a camera and take control of it.
2. In the **Axis Control** panel, select or clear the **PAN RELATIVE STEERING** check box:
  - **Selected** — Alignment of the wheels is relative to the pan position of the head. (pan-relative steering).  
 Choose this option if you want to truck or dolly the camera.
  - **Cleared** — Alignment of the wheels is relative to the CamBot target orientation (standard steering).  
 Choose this option if you want to align the pedestal relative to the target orientation.

3. Tap one of the following buttons to align the wheels:
  - **Forward/Back** — Prepares the pedestal for dollying in or out.
  - **Right/Left** — Prepares the pedestal for trucking right or left.
4. Select or clear the **AXIS JOG MODE** check box:
  - **Selected** — The axis movement buttons in the **Axis Control** panel control the pedestal.
  - **Cleared** — The joystick panel controls the pedestal.

**To truck or dolly the camera, using the joystick panel:**

1. In the **Axis Control** panel, clear the **AXIS JOG MODE** check box.
2. If you aligned the pedestal for trucking (**Right/Left** button), push the **XY joystick** right or left to move the camera.
3. If you aligned the pedestal for dollying (**Forward/Back** button), push the **XY joystick** away from you to dolly in, or pull it towards you to dolly out.

**To truck or dolly the camera, using the movement buttons in the Axis Control panel:**

1. In the **Axis Control** panel, select the **AXIS JOG MODE** check box.
2. Use the **Forward** and **Backward** buttons to move the camera.
  - If you aligned the pedestal for trucking (the **Right/Left** button), the camera moves right and left, relative to the subject.
  - If you aligned the pedestal for dollying (the **Forward/Back** button), the camera moves forward and backward, relative to the subject.

## Standard Steering and Pan-Relative Steering for XY Pedestals

When you use the left joystick to move XY pedestals, there are two steering modes:

- **Standard Steering** — The direction of pedestal movement is relative to the target sheet orientation. When you move the **X/Y/Z joystick** forward, the pedestal moves towards the set, regardless of where the camera is facing. Standard steering is the default mode.

**Note:** Because the direction of pedestal movement is relative to the target sheet orientation, it is important to orient the target as described in **“Targeting XY Pedestals”** on [page 124](#).
- **Pan-Relative Steering** — The direction of pedestal movement is relative to the orientation of the head (pan direction). When you move the **X/Y/Z joystick** forward, the pedestal moves in the direction the camera is facing. Pan-relative steering enables operators to easily move the pedestal side to side or backwards and forwards in relation to the subject, rather than the target sheet. For example, if the camera view is centered on a person who moves right, moving the joystick to the right trucks the camera right and keeps the subject in frame.

**To set the steering mode:**

1. In SmartShell, select a camera and take control of it.
2. In the **Axis Control** panel, select or clear the **PAN RELATIVE STEERING** check box:
  - **Selected** — Alignment of the wheels is relative to the pan position of the head. (pan-relative steering).
  - **Cleared** — Alignment of the wheels is relative to the target orientation (standard steering).

If you are using a CamBot XY pedestal, the **Axis Control** panel also includes buttons to automatically rotate the pedestal base, to align it parallel or perpendicular to either the target orientation or the pan position. For more information, see **“Aligning, Trucking, and Dollying XY Pedestals”** on [page 142](#).

# CamBot Local Control Box

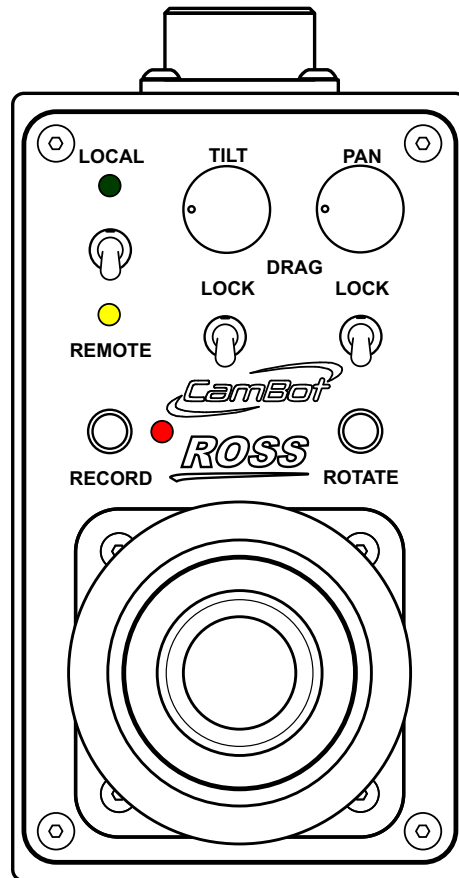
The CamBot local control box is an optional accessory that enables you to manually control a CamBot XY pedestal system locally, using pan bars and the control box itself. When you use the local control box, all commands from other control systems are ignored. The local control box is used only on cameras that include a robotic lift column and/or a robotic pedestal.

This section explains how to perform tasks using the local control box. Topics include:

- “Switching Between Remote Control and Local Control” on [page 135](#)
- “Moving the Pedestal Across the Studio Floor” on [page 136](#)
- “Raising and Lowering the Lift Column” on [page 136](#)
- “Panning and Tilting the Head” on [page 137](#)
- “Adjusting Drag for Pan and/or Tilt” on [page 137](#)
- “Locking and Unlocking Tilt and/or Pan” on [page 138](#)
- “Rotating the Pedestal Base” on [page 138](#)

**Note:** If you are using a Vinten XY pedestal, consult the Vinten manuals for information about using Vinten local control. After you finish using Vinten local control, you must retarget the pedestal. For information about targeting the pedestal, see “Targeting XY Pedestals” on [page 124](#).

[Figure 106](#) shows the local control box.



**Figure 106** - The Local Control Box

### Notes:

- The local control box does not control lens functions, such as zoom, focus, and iris. These features can be operated via controllers mounted to the pan bars (if equipped).
- The **RECORD** button is not operational. It is reserved for future use.

## Switching Between Remote Control and Local Control

Switching to local control enables you to control the pedestal system locally, using pan bars and the local control box. Switching to remote control allows the SmartShell application or an automation system to take control of the camera.

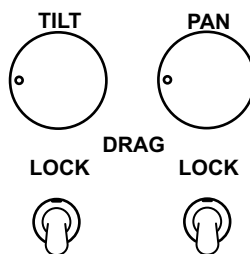
LEDs above and below the **LOCAL/REMOTE** switch indicate the current control status. Green indicates local control, and yellow indicates remote control. [Figure 107](#) shows the **LOCAL/REMOTE** switch.



**Figure 107** - The LOCAL/REMOTE Switch

### To Switch from Remote Control to Local Control

1. Ensure that the camera is at rest, meaning that
  - it is not moving,
  - it is not running a preset,
  - no automation system is moving it, or is about to move it, and
  - no one is operating it manually using the joystick panel.
2. On the local control box, put the tilt and pan lock switches in the unlocked (downward) position. This step ensures that you will be able to move the head freely as soon as you switch to local control.  
**Tip:** The lock switches are below the **TILT** and **PAN** drag knobs, as shown in [Figure 108](#).



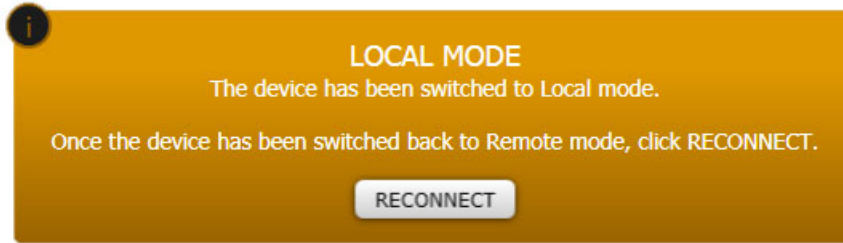
**Figure 108** - Tilt and Pan Lock Switches, in the Unlocked Position

3. Without touching the joystick on the local control box, flip the **LOCAL/REMOTE** switch to **LOCAL** and then wait at least two seconds for the local control box to take control of the pedestal system.  
After you flip the switch, the green **LOCAL** LED illuminates, and the local control box starts sending data and calibrating.

**IMPORTANT:** You must **NOT** touch the joystick for at least two seconds after switching to **LOCAL** control mode. The system calibrates the joystick based on its position, so if it is not at a neutral (untouched) position, the calibration will be inaccurate. This could cause the pedestal to move independently in an uncontrolled manner. If this happens, switch back to **REMOTE** mode.

You can now control the camera manually using the local control box and pan bars.

In SmartShell, the following message appears:



**Figure 109** - LOCAL MODE Message, Indicating that the CamBot XY Pedestal is under Local Control

#### To Switch from Local Control to Remote Control

4. Flip the **LOCAL/REMOTE** switch to the **REMOTE** (bottom) position.  
The yellow LED illuminates.  
**IMPORTANT:** After you switch to remote control, do not attempt to move the camera using pan bars.
5. Wait ten seconds for the local control box to release control of the camera.  
**IMPORTANT:** Do not switch back to local control until after ten seconds has elapsed. Otherwise, the joystick may not calibrate correctly and the pedestal may immediately start to drift. If this happens, switch back to remote control, wait ten seconds, and then switch to local control.  
**Note:** If any one or more of pan, tilt, or lift is outside limits, all three axes will return to their home position.
6. In SmartShell, tap **RECONNECT**.  
The **OPERATE** button appears.
7. Click **OPERATE** to take control of the camera.  
You can now control the camera using SmartShell and the joystick panel.

## Moving the Pedestal Across the Studio Floor

The joystick on the local control box enables you to drive the pedestal.

#### To drive the pedestal:

- Press and hold the joystick button, and then steer the pedestal by pushing the joystick.  
**Tip:** Steering directions are relative to the orientation of the head (pan-relative). When you move the joystick forward, the pedestal moves in the direction the camera is facing.  
**Tip:** Depending on how your system is configured, you may not need to press and hold the joystick button to move the pedestal.
- IMPORTANT:** When a CamBot XY pedestal is in local control mode, all axis limits for the XY axis are ignored. Pedestal movement in local mode is not restricted by any XY limits.

## Raising and Lowering the Lift Column

You can use the joystick on the local control box to raise and lower the lift column.

#### To raise or lower the lift column:

- Twist the joystick counter-clockwise to raise the lift column, or clockwise to lower it.

# Panning and Tilting the Head

You can use the pan bars to pan and/or tilt the head.

## To pan and/or tilt the head:

### 1. Ensure the tilt and pan lock switches are in the correct positions:

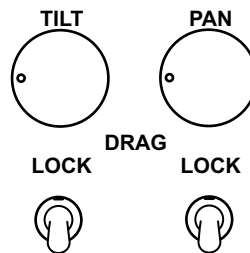
- If you want to be able to pan and tilt the head freely, ensure both switches are in the unlocked (downward) position.

**WARNING:** When operating a CamBot XY pedestal in local mode, base rotation limits and pan limits do not apply. Be careful to prevent cables becoming wrapped tightly around the pedestal.

•

- If you want to restrict movement of either pan or tilt, ensure the corresponding switch is in the locked (upward) position.

**Tip:** The lock switches are below the **TILT** and **PAN** drag knobs, as shown in [Figure 108](#).



**Figure 110** - Tilt and Pan Lock Switches, in the Unlocked Position

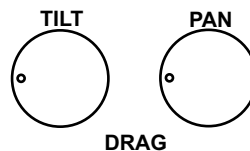
**IMPORTANT: NEVER** try to force the head to move in a locked direction. For example, if the pan lock switch is locked, do not pan. You must unlock the pan switch before you pan. Forcing the head to move in a locked direction can seriously damage the equipment.

### 2. Use the pan bars to pan and/or tilt the head.

**Tip:** You can adjust the amount of resistance you feel when you pan and tilt. For more information, see [“Adjusting Drag for Pan and/or Tilt”](#) on [page 137](#).

## Adjusting Drag for Pan and/or Tilt

You can use the **TILT** and **PAN** drag knobs to adjust the amount of resistance you feel when you pan and tilt.



**Figure 111** - TILT and PAN Drag Knobs

### To adjust the drag for pan and/or tilt:

- Turn the **TILT** knob to adjust tilt drag, or the **PAN** knob to adjust pan drag.

**Tip:** Turning the knobs clockwise increases drag. Turning them counter-clockwise decreases drag.

# Locking and Unlocking Tilt and/or Pan

You can lock tilt and/or pan to prevent movement in one direction. For example, if you want to pan smoothly without any tilt motion, you can lock tilt.

You can also lock both tilt and pan to keep the camera in its current position. This allows you to set up a stationary camera shot and step away, while maintaining local control to prevent any other control system from moving the camera.

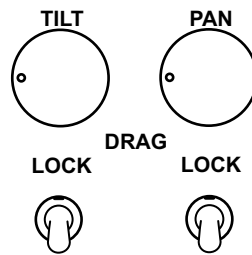
**Note:** The tilt and pan locks affect only local control. They do not affect the ability of the SmartShell application or an automation system to move the head when the camera is in remote control mode.

**To lock or unlock tilt and/or pan:**

- Flip the desired lock switch to the locked (upwards) position, or unlocked (downwards) position.

**Tip:** The tilt lock switch is below the **TILT** drag knob. The pan lock switch is below the **PAN** drag knob.

[Figure 112](#) shows the tilt and pan lock switches.



**Figure 112** - Tilt and Pan Lock Switches (Below TILT drag knob and PAN drag knob)

# Rotating the Pedestal Base

You can use the joystick on the local control box to rotate the pedestal base. As the base rotates, the head pans in the opposite direction to keep the camera view locked on its current framing.

**WARNING:** When operating a CamBot XY pedestal in local mode, base rotation limits and pan limits do not apply. Be careful to prevent cables becoming wrapped tightly around the pedestal.

**To rotate the pedestal base:**

- Press the **ROTATE** button and then twist the joystick the direction you want the pedestal to rotate.

[Figure 113](#) shows the **ROTATE** button.



**Figure 113** - ROTATE Button

# Notifications Window

The **NOTIFICATIONS** window shows warning and error messages generated by cameras. You can view messages, acknowledge them, and save a diagnostic file which you can send to support personnel to help resolve problems.

The **NOTIFICATIONS** window includes the following columns:

- **DATE/TIME** — The date and time of the problem.
- **SOURCE** — The camera that experienced the problem.
- **SEVERITY** — An indication of the severity of the problem:
  - › **INFO**: The message appears in gray text, and is for informational purposes only. For example, “CameraOne set a TEMPORARY HIGHER limit on the PAN axis”.
  - › **WARNING**: The message appears in orange text, and describes a condition that may impede continued operation. For example, if the pan axis reaches its high temporary limit, the message “Reached TEMPORARY HIGHER limit on the PAN axis” appears.
  - › **ERROR**: The message describes an error condition that prevents continued operation. For example, “A move must be cued before running. Please use the ‘CUE’ button.”.
- **DESCRIPTION** — The message content, which is a description of the problem that prompted the message.

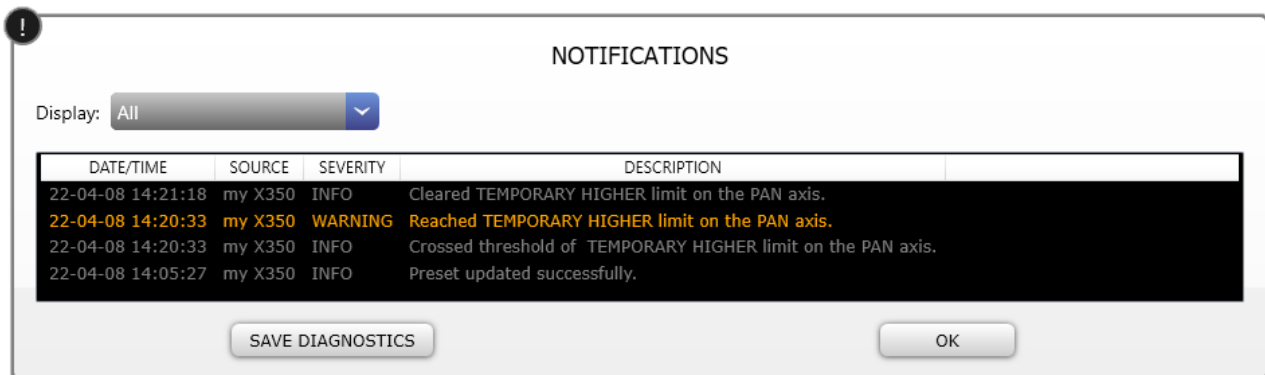
To view and acknowledge error and warning messages:

1. In the main SmartShell window, tap the **Notifications** panel at the bottom of the window ([Figure 122](#)).



**Figure 122** - The Notifications Panel

The **NOTIFICATIONS** window appears ([Figure 123](#)).



**Figure 123** - The Notifications Window

2. In the **Display** list, tap the name of the camera unit for which you want to show error and warning messages.  
**Tip:** To view messages for all cameras, tap **All**.
3. View the messages in the list.

4. To acknowledge all messages and close the **NOTIFICATIONS** window, tap **OK**.  
The **NOTIFICATIONS** window closes.

**To save a diagnostics file:**

1. In the **NOTIFICATIONS** window, tap **SAVE DIAGNOSTICS**.
2. Specify a folder where you want to save the file, and then tap **Save**.  
The diagnostics file is saved. This operation may take a few minutes. SmartShell is not available while the diagnostics file is being saved.

**Note:** The diagnostics file contains detailed information from Furio robots, and summary information from CamBot robots. To view detailed diagnostic information from CamBot robots, navigate to the **Robotics Server Host** page on the Robotics Server (<http://RoboticsServerIP:3000>), tap **Robotics Server**, and then on the **Logging** tab tap the log file you want to view.

**To close the NOTIFICATIONS window:**

- Tap **OK**.

# Glossary

This section explains terms used in this User Guide.

## ***acceleration rate***

The rate at which movement along an axis accelerates at the start of a preset or keyframe, specified as a percentage of the maximum acceleration rate. Acceleration rates are set individually for each axis of movement.

Acceleration rates can be set for Furio robotic camera systems only.

## ***ALT***

Alternative duration. A custom duration value that overrides a preset duration.

## ***axis jog mode***

Manual control of a camera system using buttons in the SmartShell user interface, as opposed to joystick control or automatic control using presets and/or moves.

## ***alternative cue/cut speed***

This feature reduces the speed of robotic motion while a camera system performs a cut to preset or an action that requires cueing. For more information, see “**Alternative Cue/Cut Speed**” on [page 42](#).

## ***automation control system***

A system that can control multiple broadcast technologies such as production switchers, video servers, teleprompters, and robotic cameras.

CamBot and Furio robots can be controlled directly by certain types of automation control systems.

## ***axis***

The range of motion for one aspect of camera system movement. Each camera system includes some of the following axes: pan, tilt, zoom, focus, lift, track, and XY. Pan and tilt are camera head rotations. Zoom and focus are lens movements. Lift applies to camera systems that have lift columns. Track is a Furio dolly movement. XY is a CamBot XY pedestal movement.

## ***Axis Activation panel***

An area of the SmartShell interface within which you specify which axes the joystick panel can control. Deactivating axes can help prevent unintentional movement of the camera system.

## ***Axis Control panel***

An area of the SmartShell interface within which you configure axis behavior for manual and joystick operation, and can control each axis manually.

For more information, see “**Axis Configuration**” on [page 111](#) and “**Manual Operation in SmartShell**” on [page 139](#).

## ***axis limits***

The maximum and minimum values for a given axis. Axis limits are set in the **Axis Control** panel, and persist until the head is restarted.

For more information, see “**View and Set Temporary Axis Limits**” on [page 114](#).

## ***CamBot***

A family of robotic camera systems produced by Ross Robotics. CamBot is designed for live television production studio use in which typically a single operator controls multiple cameras with preset shot recalls. SmartShell is the control interface for the CamBot system.

### **Camera Group**

A camera group is a list of cameras that defines which cameras are available for SmartShell control. The **Camera Selection** panel displays one button for each camera in the current camera group. Camera groups can be saved and later loaded into SmartShell.

For more information, see “**Working with Camera Groups**” on [page 22](#).

### **Camera Selection panel**

An area of the SmartShell interface within which you can select a camera system to control. SmartShell shows status information, presets, and moves for the selected camera system. The blue camera selection button indicates which camera system is currently selected.

### **camera system (camera)**

Each camera system consists of a camera plus a robotic mechanism that moves the camera and controls zoom and focus of the lens. Each camera system includes a pan/tilt robotic head. Optional robotic components include lift columns, Furio track-mounted dollies, and CamBot XY pedestals.

In this User Guide, camera systems are also called **cameras**.

### **Camera view**

One of three main interfaces available in SmartShell, the others being Matrix view and Joystick Control Settings view.

The Camera view is an interface that enables you to control camera systems, create moves and presets, and configure axis limits and other axis settings. Camera view is often considered the “main” interface. When you launch SmartShell, it opens in Camera View mode.

For more information, see “**SmartShell User Interface**” on [page 10](#).

### **categories**

Groups of presets or moves, arranged on tabs within the Presets panel or Moves panel. Categories enable you to organize presets and moves for easier access during a show.

### **clone**

A copy of a preset, a move, or a category. Cloning enables you to create new presets, moves and categories based on existing ones.

### **cue move**

To move a camera system to the starting position of a move.

### **cue preset**

To rotate the wheels of a CamBot XY pedestal, to prepare it to run a preset. Cueing is not mandatory, but can improve the visual appearance of on-air shots.

### **cut**

A command that moves a camera unit to a preset position as quickly as possible, overriding the preset values for duration, acceleration rate, and deceleration rate.

### **damping slider**

Sets the acceleration rate and deceleration rate for the selected axis when the camera system is controlled manually. The value is a percentage of the configured maximum acceleration and deceleration rates.

### **deceleration rate**

The rate at which movement along an axis decelerates at the end of a preset or keyframe, specified as a percentage of the maximum deceleration rate. deceleration rates are set individually for each axis of movement.

Deceleration rates can be set for Furio robotic camera systems only.

**duration**

The amount of time, in seconds, allotted to move a camera system to a preset position. The duration value is set as part of the preset definition.

**external ID**

An identification number assigned to a move or preset. External IDs enable automation control systems to address and run moves and presets. Not all automation control systems require that moves and presets have external IDs.

You can assign external IDs when you create or edit moves or presets. If your system is configured to interact with an automation control system that requires external IDs, an **External ID** box is available on the **ADD PRESET**, **EDIT PRESET**, **ADD MOVE**, and **EDIT MOVE** dialog boxes.

**fixed camera**

A robotic camera system with no track axis and no lift axis.

**focus axis**

One movement axis of a camera system. Movement along the focus axis focuses the camera. The directions of axial movement are **Near** and **Far**.

**Furio Robo**

A family of robotic camera systems produced by Ross Robotics. Furio Robo is designed for live television production studio use in which typically a single operator controls multiple cameras with preset shot and motion path recalls. SmartShell is the control interface for the Furio Robo system.

**homing**

Part of the initialization process of a camera system, during which the camera system may move to a predefined home position. The camera system determines its position in all axes and relays this information to SmartShell. Homing starts when you tap the OPERATE button in SmartShell.

**invert axis**

To reverse the direction of a control axis for more intuitive operation. For example, if you set up a camera system and find that pushing the X-Y joystick to the right moves the camera system to your left, you can invert the track axis so the direction of joystick movement corresponds to the movement of the camera system.

**Joystick Control Settings view**

One of three main interfaces available in SmartShell, the others being Camera view and Matrix view. The Joystick Control Settings view is an interface that enables you to configure how each axis of each camera system responds to joystick movements. For example, you can set the maximum speed and damping ratio for the PAN axis of a specific camera system.

You can copy settings between cameras systems, and save settings in user settings (.usettings) files.

For more information, see "**Joystick Control Settings**" on [page 101](#).

**joystick panel**

A hardware device for manually controlling camera systems in conjunction with SmartShell software. The joystick panel can control several camera systems. The joystick panel enables you to control multiple axes of a camera system simultaneously, for smooth camera operation.

When the joystick panel is referred to, and there is no distinction between the Legacy Joystick Panel, or the CX-3R Joystick Panel, then the features described apply to both.

For more information, see "**The Joystick Panel**" on [page 90](#).

**keyframe**

A preset position added to the timeline of a move. A move consists of a series of keyframes. Each keyframe consists of a preset position and a distance. The distance is the number of seconds between when the move starts and when the camera system reaches the preset position.

Moves are available for Furio robotic camera systems, and CamBot XY pedestals running Furio firmware version 5.2 (or higher).

For more information, see “**Moves**” on [page 46](#).

**lift axis**

One movement axis of a camera system. Movement along the lift axis lifts or lowers the camera by extending or retracting the telescopic camera pedestal. The directions of axial movement are **Up** and **Down**.

**local control box**

An optional accessory that enables you to manually control a CamBot XY pedestal system locally, using pan bars and the control box itself. When you use the local control box, all commands from other control systems are ignored. The local control box is used only on camera systems that include a robotic lift column and/or a robotic pedestal.

**looped move**

A looped move is a move that cycles indefinitely (until stopped). For more information, see “**Create a Looped Move**” on [page 63](#).

**macro**

A macro is a group of presets represented by a macro button in the Matrix view. When a macro runs, all of its presets run. Macros enable you to efficiently put multiple camera systems into motion at the same time. Each preset within a macro is for a separate camera system.

**Matrix View**

One of three main interfaces available in SmartShell, the others being Camera view and Joystick Control Settings view.

The Matrix view consists of a panel of buttons that enable you to efficiently operate multiple camera systems.

Each button represents a predefined action such as cueing/running a move, cutting to a preset, and cueing/running a preset. In the Matrix, you can create, store, and perform hundreds of actions.

**move**

A series of presets on a timeline. For each preset in the move, the time at which the preset position is reached (also called distance) is defined. The combination of a preset and distance in a move is called a keyframe. When a move is recalled, the camera system moves from the first preset position, through each of the others, to the last. For each keyframe, the camera system reaches the associated preset position at the time specified by the keyframe’s distance.

Moves are available for Furio robotic camera systems, and CamBot XY pedestals running Furio firmware version 5.2 (or higher).

For more information, see “**Moves**” on [page 46](#).

**moves panel**

A panel in SmartShell that includes tools to help create, edit, and run move sequences. It consists of two main areas: the keyframes area (top) and the moves area (bottom).

In the moves area, you can add, edit, verify, and delete moves. You can also run moves. When you select a move in the moves area, the keyframes that form the move appear in the keyframes area. You can edit the properties of the keyframes to change how the camera system behaves when the move runs.

Moves and the **Moves Panel** are available for Furio robotic camera systems, and CamBot XY pedestals running Furio firmware version 5.2 (or higher).

For more information, see “**Moves**” on [page 46](#).

### ***pan axis***

One movement axis of a camera system. Movement along the pan axis rotates (pans) the camera right and left.

### ***panel mode***

One of two SmartShell operation modes, the other being shot box mode. The only difference between the modes is the order in which you tap objects in the interface.

In panel mode, you generally tap the item you want to affect, and then tap the action you want to apply to it.

To determine which mode your SmartShell computer uses, tap the **Help** button (?). In the **Welcome** topic, the **Control Modes** section indicates the current control mode. It also provides a hyperlink to the corresponding edition of the SmartShell User Guide.

**Note:** The control mode is set during system commissioning. For more information, contact technical support.

### ***Pan-relative steering***

One of two modes for steering CamBot XY pedestals using the joystick panel. The other mode is standard steering. In pan-relative steering mode, the direction of pedestal movement is relative to the orientation of the head (pan position). In standard steering mode, the direction of pedestal movement is relative to the target sheet orientation.

For more information, see “**Standard Steering and Pan-Relative Steering for XY Pedestals**” on [page 143](#).

### ***preset***

A preset is a stored camera system position that can be recalled.

For more information, see “**Presets**” on [page 25](#).

### ***presets panel***

An area of the SmartShell interface that shows presets for a camera system, and includes tools to add, edit, cue, run, and delete presets.

For more information, see “**Presets**” on [page 25](#).

### ***robotic pan tilt head***

The robotic mechanism that carries the camera and provides camera rotation (pan or tilt).

### ***rescaling a move***

Rescaling a move changes the total duration of the move. Rescaling increases or reduces the allotted time between each pair of keyframes proportionally. For more information, see “**Edit a Move**” on [page 62](#).

### ***run***

To recall a preset or move over a specified duration.

### ***Quick Focus***

The **Quick Focus** feature enables you to zoom the lens in fully, focus perfectly on an object of your choice, and then zoom out without affecting other axes of motion. Zooming in to focus enables you to focus more precisely.

For more information, see “**Using Quick Focus to Fine-Tune the Focus**” on [page 141](#).

**shot box mode**

One of two SmartShell operation modes, the other being panel mode. The only difference between the modes is the order in which you tap objects in the interface.

In shot box mode, you generally tap the action you want to perform, and then tap the item you want to affect.

To determine which mode your SmartShell computer uses, tap the **Help** button (?). In the **Welcome** topic, the **Control Modes** section indicates the current control mode. It also provides a hyperlink to the corresponding edition of the SmartShell User Guide.

**Note:** The control mode is set during system commissioning. For more information, contact technical support.

**joystick control**

Control of an axis by an input device such as a joystick panel, or manual control of an axis by buttons in the **Axis Control** panel of SmartShell.

**speed slider**

Sets the maximum speed for the selected axis when the camera system is controlled manually. The value is a percentage of the configured maximum speed.

**thumbnail**

A small image of a camera view from a preset position. Thumbnails help the operator identify which presets to run, or to add to a move.

This option is available only if your Ross Robotics system is configured to include thumbnails.

**tilt axis**

One movement axis of a camera system. Movement along the tilt axis angles (tilts) the camera up and down.

**track axis**

One movement axis of a camera system. Movement along the track axis moves the camera dolly left and right along the track.

The track axis applies to track-mounted Furio dollies only.

**verify moves**

To test whether a move can be run within the allotted time.

**XY axis**

One movement axis of a CamBot XY camera system. Movement along the XY axis moves the CamBot XY pedestal along the studio floor.

**zoom axis**

One movement axis of a camera system. Movement along the zoom axis changes the focal length of the camera lens. The directions of axial movement are **Tele** (telephoto) and **Wide**.

**ZOOMVAR**

ZOOMVAR, which applies to manual control only, varies the speed of certain axes (pan, tilt) based on the value of the zoom axis to make the motion appear smoother. When the lens is zoomed in, the affected axis moves more slowly. When the lens is zoomed out, the affected axis moves more quickly.