

---

# XPression<sup>TM</sup>

## Maintenance Guide



Video Production Technology

## XPression • Maintenance Guide

- Ross Part Number: **3503DR-005-01**
- Release Date: November 8, 2012. Printed in Canada.

The information contained in this Guide is subject to change without notice or obligation.

## Copyright

© 2012 Ross Video Limited. All rights reserved.

This work is proprietary and confidential to Ross Video Limited, its subsidiaries and its other affiliated corporations and may not be copied, distributed, sold or otherwise used or relied upon without the express written permission of Ross Video Limited. Reproduction or reverse engineering of copyrighted software is prohibited.

## Notice

The material in this manual is furnished for informational use only. It is subject to change without notice and should not be construed as commitment by Ross Video Limited. Ross Video Limited assumes no responsibility or liability for errors or inaccuracies that may appear in this manual.

## Trademarks

-  is a registered trademark of Ross Video Limited.
- Ross, ROSS, ROSS®, and XPression™, are registered trademarks of Ross Video Limited.
- Microsoft® and Windows® are registered trademarks of Microsoft Corporation.
- Intel® and Pentium® are registered trademarks of Intel Corporation.
- All other product names and any registered and unregistered trademarks mentioned in this guide are used for identification purposes only and remain the exclusive property of their respective owners.

## Important Regulatory and Safety Notices to Service Personnel

Before using this product and any associated equipment, refer to the "Important Safety Instructions" listed below so as to avoid personal injury and to prevent product damage.

Products may require specific equipment, and /or installation procedures be carried out to satisfy certain regulatory compliance requirements. Notices have been included in this publication to call attention to these specific requirements.

### Symbol Meanings



---

**Protective Earth** — *This symbol identifies a Protective Earth (PE) terminal, which is provided for connection of the supply system's protective earth (green or green/yellow) conductor.*

---



---

*The exclamation point within an equilateral triangle is intended to alert the user to the presence of important operating and maintenance (servicing) instructions in the literature accompanying the product. Failure to heed this information may present a risk of damage or injury to persons or equipment.*

---



---

**Warning** — *The symbol with the word "Warning" within the equipment manual indicates a potentially hazardous situation, which if not avoided, could result in death or serious injury*

---



---

**Caution** — The symbol with the word "**Caution**" within the equipment manual indicates a potentially hazardous situation, which if not avoided, may result in minor or moderate injury. It may also be used to alert against unsafe practices.

---



---

**Notice** — The symbol with the word "**Notice**" within the equipment manual indicates a situation, which if not avoided, may result in major or minor equipment damage or a situation, which could place the equipment in a non-compliant operating state.

---



---

**Warning Hazardous Voltage** — The lightning flash with arrowhead symbol within an equilateral triangle is intended to alert the user to the presence of uninsulated "dangerous voltage" within the product's enclosure that may be of sufficient magnitude to constitute a risk of shock to persons.

---



---

**ESD Susceptibility** — This symbol is used to alert the user that an electrical or electronic device or assembly is susceptible to damage from an ESD event.

---

### Important Safety Instructions

- 1) Read these instructions.
- 2) Follow all instructions and heed all warnings.
- 3) Refer all servicing to qualified service personnel.
- 4) The equipment's AC appliance inlets are the means to disconnect the product from the AC Mains and must remain readily operable for this purpose.
- 5) Parts of the equipment's power supplies can still present a safety hazard even when the product is in the "OFF" state. To avoid the risk of electrical shock and to completely disconnect the apparatus from the AC Mains, remove all power supply cords from the product's AC appliance inlets prior to servicing.
- 6) If the product nameplate indicates that the chassis is "Rack Mounted", it is to be rack mounted only. To ensure safe operation and maintain long-term system reliability, proper installation requires that the front and back area of the chassis remain clear of obstructions so as not to restrict airflow.



#### Warning

7) No operator access to internal parts in this product. The power supply outputs are considered an Energy Hazard (>240VA). To avoid the risk of contact with the Energy Hazard and to completely de-energize the apparatus, remove all power supply cords from the product's AC appliance inlet(s) prior to servicing.



#### Warning

8) Indoor Use: To reduce the risk of fire or electric shock, do not expose this apparatus to rain or moisture.



#### Warning

9) This product includes an "Ethernet Port" which allows this product to be connected to a local area network (LAN). Only connect to networks that remain inside the building. Do not connect to networks that go outside the building.



#### Caution

10) This apparatus contains a Lithium battery, which if replaced incorrectly, or with an incorrect type, may cause an explosion. Replace only with the same type recommended by the manufacturer. Dispose of used batteries according to the manufacturer's instruction by qualified service personnel.

## EMC Notices

### US

#### FCC Part 15

This equipment has been tested and found to comply with the limits for a class A Digital device, pursuant to part 15 of the FCC Rules. These limits are designed to provide reasonable protection against harmful interference when the equipment is operated in a Commercial environment. This equipment generates, uses, and can radiate radio frequency energy and, if not installed and used in accordance with the instruction manual, may cause harmful interference to radio communications. Operation of this equipment in a residential area is likely to cause harmful interference in which case the user will be required to correct the interference at his own expense.



**Notice** Changes or modifications to this equipment not expressly approved by Ross Video Ltd. could void the user's authority to operate this equipment.

### CANADA

This Class "A" digital apparatus complies with Canadian **ICES-003**.

Cet appareil numérique de la classe "A" est conforme a la norme **NMB-003** du Canada.

### EUROPE

This equipment is in compliance with the essential requirements and other relevant provisions of **CE Directive 93/68/EEC**.

### AUSTRALIA

This equipment has been tested to **AS/NZS CISPR22:2009** and found to comply with the limits for a Class A Digital device.

### INTERNATIONAL

This equipment has been tested to **CISPR 22:2009** and found to comply with the limits for a Class A Digital device.



**Notice** This is a Class A product. In domestic environments, this product may cause radio interference, in which case the user may have to take adequate measures.

## Warranty and Repair Policy

Ross Video Limited (Ross) warrants its XPression systems to be free from defects under normal use and service for the following time periods from the date of shipment:

- **XPression Server** — 12 months
- **XPression Software Upgrades** — 12 months free of charge
- **System hard drives** — 54 months

If an item becomes defective within the warranty period Ross will repair or replace the defective item, as determined solely by Ross.

Warranty repairs will be conducted at Ross, with all shipping FOB Ross dock. If repairs are conducted at the customer site, reasonable out-of-pocket charges will apply. At the discretion of Ross, and on a temporary loan basis, plug in circuit boards or other replacement parts may be supplied free of charge while defective items undergo repair. Return packing, shipping, and special handling costs are the responsibility of the customer.

This warranty is void if products are subjected to misuse, neglect, accident, improper installation or application, or unauthorized modification.

In no event shall Ross Video Limited be liable for direct, indirect, special, incidental, or consequential damages (including loss of profit). Implied warranties, including that of merchantability and fitness for a particular purpose, are expressly limited to the duration of this warranty.

This warranty is TRANSFERABLE to subsequent owners, subject to Ross' notification of change of ownership.

## Extended Warranty

For customers that require a longer warranty period, Ross offers an extended warranty plan to extend the standard warranty period by one year increments. For more information about an extended warranty for your XPression system, contact your regional sales manager.

## Environmental Information

The equipment that you purchased required the extraction and use of natural resources for its production. It may contain hazardous substances that could impact health and the environment.

To avoid the potential release of those substances into the environment and to diminish the need for the extraction of natural resources, Ross Video encourages you to use the appropriate take-back systems. These systems will reuse or recycle most of the materials from your end-of-life equipment in an environmentally friendly and health conscious manner.

The crossed-out wheeled bin symbol invites you to use these systems.

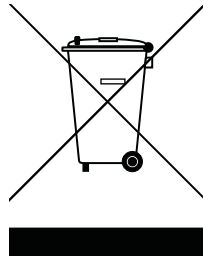

If you need more information on the collection, reuse, and recycling systems, please contact your local or regional waste administration.

You can also contact Ross Video for more information on the environmental performances of our products.

## Company Address

### Ross Video Limited

8 John Street  
Iroquois, Ontario  
Canada, K0E 1K0

### Ross Video Incorporated

P.O. Box 880  
Ogdensburg, New York  
USA 13669-0880

### Ross Video Europe

Sumatralaan 45  
Gateway D  
Hilversum, Noord-Holland 1217 GP

---

**General Business Office:** (+1) 613 • 652 • 4886

**Fax:** (+1) 613 • 652 • 4425

**Technical Support:** (+1) 613 • 652 • 4886

**After Hours Emergency:** (+1) 613 • 349 • 0006

**E-mail for Technical Support:** [techsupport@rossvideo.com](mailto:techsupport@rossvideo.com)

**E-mail for General Information:** [solutions@rossvideo.com](mailto:solutions@rossvideo.com)

**Website:** <http://www.rossvideo.com>



# Contents

<b>Introduction</b>	<b>1</b>
About This Guide.....	1-1
Documentation Conventions.....	1-1
Getting Help.....	1-1
<b>Hardware Installation</b>	<b>2</b>
Hardware Overview .....	2-1
Hardware Installation.....	2-6
<b>Hard Drive Maintenance</b>	<b>3</b>
MegaRAID Storage Manager .....	3-1
RAID Array Consistency Check.....	3-3
RAID Array Drive Replacement.....	3-4
<b>Hardware Maintenance</b>	<b>4</b>
Front Door Filter Maintenance .....	4-1
Replacing a System Drive.....	4-5
Removing and Re-Installing the Top Panel .....	4-9
Replacing Cooling Fans .....	4-12
Accessing the USB Security Dongle .....	4-20
Replacing Power Supplies .....	4-21
<b>Appendix A: Pinouts</b>	<b>A</b>
GPI I/O Port Pinouts .....	A-1
RS232.....	A-1
<b>Appendix B: Breakout Cables and Breakout Box</b>	<b>B</b>
Matrox Breakout Cables .....	B-1
Matrox Breakout Box .....	B-2



# Introduction

Thank you for choosing a Ross Video XPression system.

Ross Video designed the XPression product line with the needs of live production in mind. XPression is an easy to use, yet powerful, 3D graphics and character generator. There are a range of XPression systems tailored to suit a variety of needs.

We appreciate your business and sincerely hope that you have a great experience with your new XPression system. As always, if there is anything that we at Ross Video can do to assist you, please do not hesitate to contact us.

## About This Guide

This guide covers the installation and maintenance of the XPression system. Refer to this guide and the accompanying Getting Started guide when your first install or need to reconfigure your system.

If, at any time, you have a question pertaining to the operation of the XPression system, please contact Ross Video at the numbers listed in the section “**Contacting Technical Support**” on page 1–2. Our technical staff are always available for consultation, training, or service.

## Documentation Conventions

Special text formats are used in this guide to identify parts of the user interface, text that a user must type, or a sequence of menus and submenus that must be followed to reach a particular command.

<b>Bold text</b>	Bold text is used to identify a user interface element such as a dialog box, menu item, or button. For example: In the <b>IBP SD 4:2:0 Compression Options</b> dialog box, select the <b>ZigZag Scan</b> option, and click <b>OK</b> .
Courier text	Courier text is used to identify text that a user must type. For example: At the prompt, type <code>c:\windows\system32</code> .
<i>Italic text</i>	Italic text is used to identify the titles of referenced guides, manuals, or documents. For example: For more information, refer to the section “ <b>Input Channel Configuration</b> ” on page 4–16 in the <i>XPression Installation and Configuration Guide</i> .
>	Menu arrows are used in procedures to identify a sequence of menu items that you must follow. For example, if a step reads “ <b>Server &gt; Save As</b> ,” you would click the <b>Server</b> menu and then click <b>Save As</b> .

## Getting Help

The XPression system Online Help system is accessed by selecting **Help Topics** from the **Help** menu. Alternatively, press the **F1** key while working with the XPression software.

The Online Help system contains navigation tabs to aid in locating information contained in the Online Help topics.

## Contacting Technical Support

At Ross Video, we take pride in the quality of our products, but if problems occur, help is as close as the nearest telephone.

Our 24-hour Hot Line service ensures you have access to technical expertise around the clock. After-sales service and technical support is provided directly by Ross Video personnel. During business hours (eastern time), technical support personnel are available by telephone any time. After hours and on weekends, a direct emergency technical support phone line is available. If the technical support person who is on call does not answer this line immediately, a voice message can be left and the call will be returned shortly. This team of highly trained staff is available to react to any problem and to do whatever is necessary to ensure customer satisfaction.

- **Technical Support:** (+1) 613-652-4886
- **After Hours Emergency:** (+1) 613-349-0006
- **E-mail:** techsupport@rossvideo.com
- **Website:** <http://www.rossvideo.com>

# Hardware Installation

This chapter provides a brief overview of and installation instructions for the XPression system hardware.

## Hardware Overview

This section provides a brief overview of the XPression system hardware.

### Front View of the System

The following diagrams display the front of the XPression system (**Figure 2.1**) with the front door removed. Descriptions of individual components are contained in the legend below the diagram.

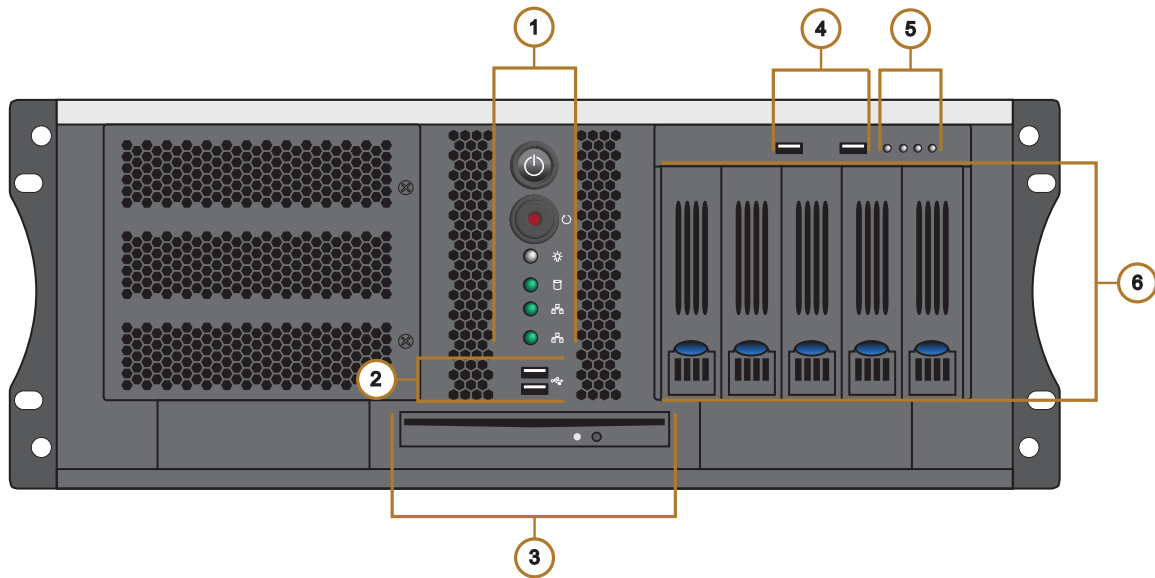

**Figure 2.1** Front View of XPression System

#### 1. Power LED Area

This area includes the XPression system Power button and LEDs for system components. Refer to the section, “**Power LED Area**” on page 2–2 for further information.

#### 2. USB Ports

These ports can be used to transfer media to and from USB drives.

#### 3. DVD-RW Drive

This drive can be used to transfer media onto drives, or create copies of existing media on CD or DVD for use elsewhere in a production environment. CD or DVD burning software must be installed on the XPression system before media can be saved to CD or DVD.

#### 4. HDD USB Ports

These ports are inactive.

#### 5. HDD Alarm LED Area

This area includes the alarm LEDs for the HDD hardware. Refer to the section, “**HDD Alarm LED Area**” on page 2–2 for further information.

## 6. System Drives

XPression systems are equipped with four system drives in a RAID 1+0 configuration to provide redundancy in case of a drive failure.

This arrangement allows for a single drive failure without loss of data or performance.

### Power LED Area

The Power LED area is located on the front of the XPression system, in the middle top of the chassis. This area contains the Power button for the XPression system, as well as activity LEDs for system components. Refer to the section “**Front View of the System**” on page 2–1 to locate the Power LED Area on the front of the XPression system.

The following diagram (**Figure 2.2**) displays the Power LED Area of the XPression system. Descriptions of individual components are contained in the legend below the diagram.

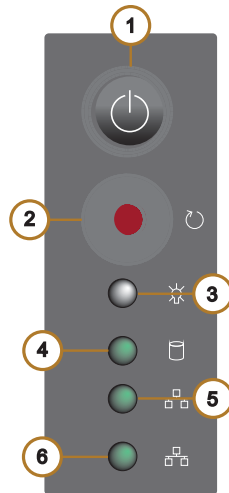

**Figure 2.2** Power LED Area

#### 1. Power Button

Press this button to begin the boot procedure. Press and hold the button for five seconds to power down the system after a hardware or software failure.

#### 2. Reset Button

Press this button to reset the system after a hardware or software failure. Pressing this button also reboots the system.

#### 3. Power Active Indicator LED

This LED is active when the system is powered on.

#### 4. Hard Disk Activity LED

This LED activates when there is read/write activity on any system hard disk.

#### 5. Network 1 Activity LED

This LED is not active.

#### 6. Network 2 Activity LED

This LED is not active.

### HDD Alarm LED Area

The HDD Alarm LED area is located on the front of the XPression system, in the top-right of the chassis above the system drives. This area contains the alarm LEDs for the HDD hardware. Refer to the section “**Front View of the System**” on page 2–1 to locate the HDD Alarm LED Area on the front of the XPression system.

The following diagram (**Figure 2.3**) displays the HDD Alarm LED Area of the XPression system. Descriptions of individual components are contained in the legend below the diagram.



**Figure 2.3** HDD Alarm LED Area

#### **1. Alarm Mute Button**

The alarm mute button is not active.

#### **2. Temperature Alarm LED**

This LED activates when the temperature inside the HDD hardware rises above the recommended operating temperature. This LED is accompanied by an audible alarm.

#### **3. Fan Failure Alarm LED**

This LED activates when a cooling fan in the HDD hardware has failed, and requires replacing. This LED is accompanied by an audible alarm.

#### **4. HDD Failure Alarm LED**

This LED activates when one or more system drives in the HDD hardware have failed. This LED is accompanied by an audible alarm.

## XPression Rear Input/Output Connections

The following diagram (Figure 2.4) displays the Input/Output portion of the XPression system. Descriptions of individual components are contained in the legend below the diagram.

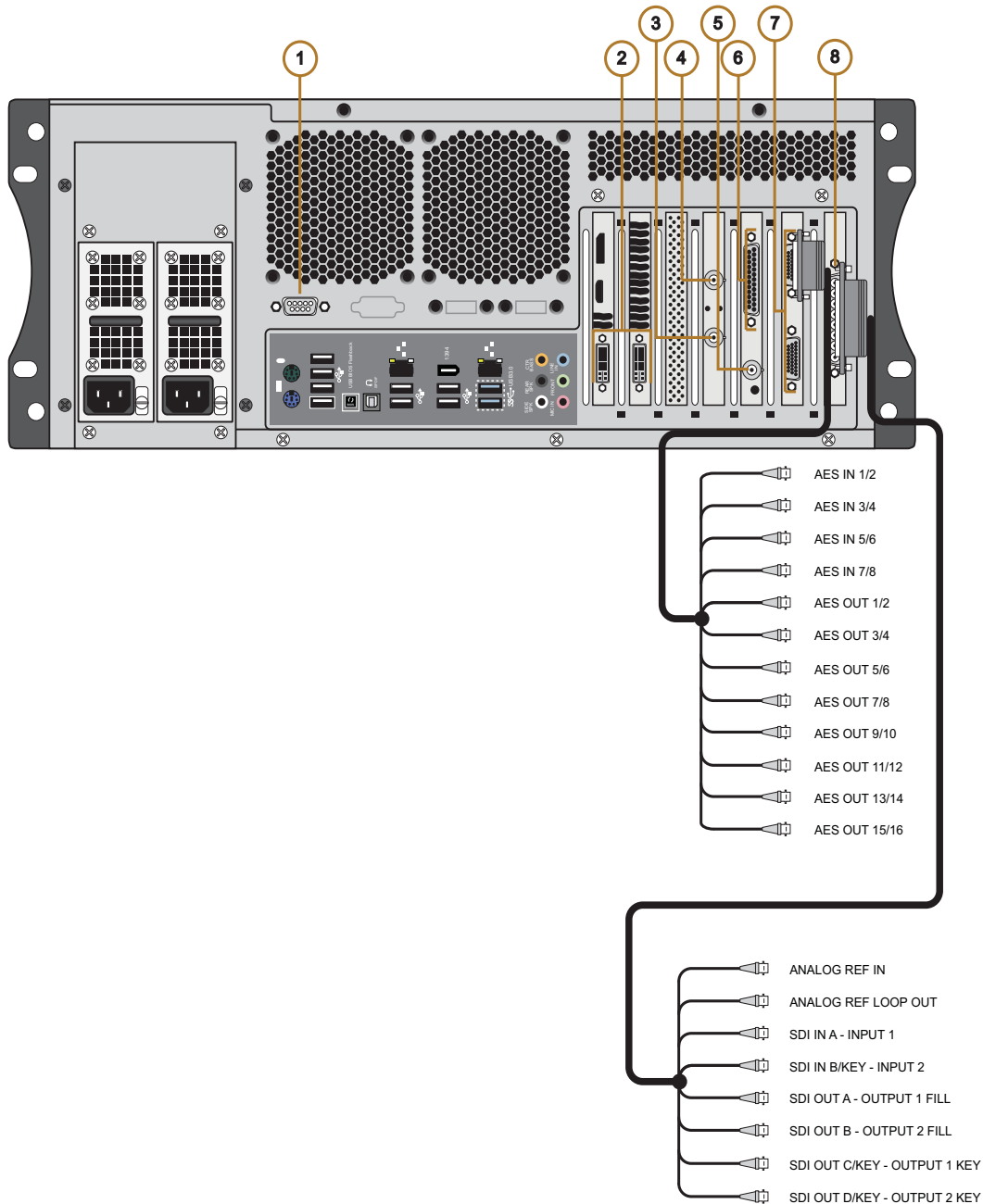

**Figure 2.4** XPression Rear Input/Output Connections

### 1. RS232 Port

Provides GPI and CII command functionality.

### 2. DVI Ports

Two DVI-I ports provide outputs for computer monitors. Digital monitors are recommended, however, analog monitors are supported via VGA-DVI adapters.

### 3. SDI Input 3

Used for video source that is mapped onto a material and as fill. It is also used as a live source for the chroma key option.

### 4. SDI Input 4

Used for video source that is mapped onto a material and as fill. It is also used as a live source for the chroma key option.

### 5. LTC Input BNC

Not currently supported.

### 6. GPI Port

DB25 GPI I/O port supports a total of 12 GPI inputs and 12 GPI outputs.

### 7. Matrox Audio Breakout Cable

Provides 8 AES audio pairs (1/2 to 15/16). You can add a second breakout cable for AES 17/18 to AES 31/32. Refer to the section, “**Matrox Breakout Cables**” on page B-1 for further information.

### 8. Matrox Video Breakout Cable

Provides SDI video input and output, as well as analog reference. Refer to the section, “**Matrox Video Breakout Cable**” on page B-1 for further information.

## Rear Peripheral Connections

The following diagram (**Figure 2.5**) displays the peripheral connections under the Input/Output connections. Descriptions of individual components are contained in the legend below the diagram.

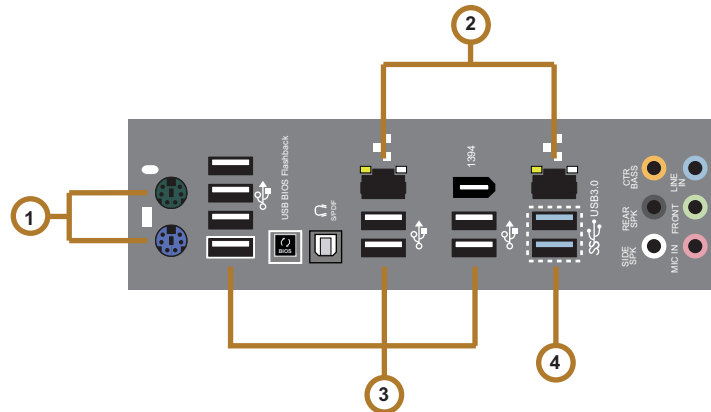

**Figure 2.5** Rear Peripheral Connections

### 1. PS/2 Ports

Use these ports to connect peripheral devices such as a keyboard or mouse to the system.

### 2. GigE Ethernet Ports

Use these ports to connect the XPression system to an internal network. These ports can be used for high-speed file transfer between the XPression system and other computers on the internal network.

### 3. USB 2.0 Ports

Use these ports to connect peripheral devices such as a keyboard or mouse to the system. These ports can also be used to transfer media to and from USB drives.

These ports support a maximum of 480 Mbit/s.

## 4. USB 3.0 Ports

Use these ports to connect peripheral devices such as a keyboard or mouse to the system. These ports can also be used to transfer media to and from USB drives.

The ports support a maximum of 5 Gbit/s.

★ Use of USB 3.0 certified cable and devices are required for USB 3.0 super-speed data rates.

## Power Supplies

The XPression system has two identical hot-swappable power supplies, located at the rear of the system on the left-hand side. Since the system requires a minimum of one power supply to operate, only one power supply can be hot-swapped at a time. Each power supply can be attached to a separate power circuit to provide redundancy in case of power failure.

The diagram (**Figure 2.6**) displays the parts of the power supply for the XPression system. Descriptions of individual components are contained in the legend below the diagram.

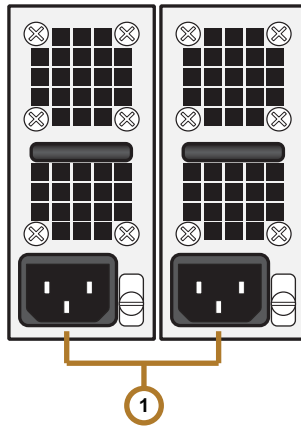

**Figure 2.6** XPression system Power Supply Unit

### 1. A/C Power Cord Connection

Connect the female end of the power cord to this connector, and the male end to a power circuit.

## Hardware Installation

The following sections provide installation instructions for the XPression system hardware.

### Unpacking the Unit

Unpack the XPression system from the received shipping container(s), and check the contents against the packing list to ensure all items are included. If any items are missing or damaged, contact your sales representative or Ross Video for assistance.

## Installation Requirements

Note the following installation requirements:

- **Elevated Operating Ambient** — If installed in a closed or multi-rack assembly, the operating ambient temperature of the rack environment may be greater than the room ambient. Therefore, consideration should be given to installing the equipment in an environment compatible with the maximum ambient temperature (T<sub>ma</sub>).
- **Reduced Air Flow** — Installation of the equipment in a rack or as a desktop/tower should be such that the amount of air flow required for safe operation of the equipment is not compromised.
- **Mechanical Loading** — Mounting of the equipment in the rack should be such that a hazardous condition is not achieved due to uneven mechanical loading.
- **Circuit Overloading** — Consideration should be given to the connection of the equipment to the supply circuit and the effect that overloading of the circuits might have on overcurrent protection and supply wiring. Appropriate consideration of equipment nameplate rating should be used when addressing this concern.
- **Reliable Earthing** — Reliable earthing of rack and desktop/tower mounted equipment should be maintained. Particular attention should be given to supply connections other than direct connections to the branch circuit (e.g. use of power strips).

### Installing the System in an Equipment Rack

The XPression system is designed to be rack mounted in a 16.9 inch wide equipment rack using the slide rails in the supplied rack mount kit.

- **Rack** — 16.9 inch (43.0 cm) wide equipment rack
- **Rack Units** — 4 RU
- **Height** — 6.5 inches (17.6 cm)
- **Depth** — 23 inches, including rear power supply handles (58.5 cm)

The slide rails must be installed onto the XPression system before it can be mounted in an equipment rack. Instructions for mounting the slide rails onto the XPression system and equipment rack are included with the rack mount kit in the XPression system shipping box.

- ★ Failure to install the XPression system into an equipment rack using the supplied rack mount kit will void the XPression system warranty.

### Installation Instructions

Note the following installation instructions:

1. This equipment has an operating temperature range of 0° C to 35° C. The ambient temperature in the rack shall not exceed this temperature range.
2. A minimum clearance of 0.25” on each side of the equipment must be maintained after installation in the rack.
3. Take care not to compromise the stability of the rack by installing this equipment.

### Attaching the Cables

**To attach the cables to the XPression system:**

1. On the back of the XPression system, connect the supplied line cords to the two power supplies, then plug the line cord(s) into a grounded outlet.  
  
The power supplies are auto-sensing and can accept line voltages from 100 through 240VAC. The XPression system is equipped with two power supplies in a 1+1 redundant configuration. One power supply is required to run the XPression system.
2. Plug the supplied USB keyboard into the upper **USB** port on the back of the XPression system.
3. Plug the supplied USB mouse into the lower **USB** port.
4. Connect a monitor, customer supplied, to the **DVI 1** port.

An additional monitor can be connected to the **DVI 2** port to provide additional space for virtual preview channels, custom applications, web page capture, and more.

5. Plug an Ethernet cable from the internal network into one of the **GigE Ethernet** ports.

XPression systems can run standalone or accept a network connection if required to connect to a production network. XPression systems also use this TCP/IP network connection to support the Smart GPI Feature.

6. Connect the GenLock signal cable to the **REF IN BNC** connector on the breakout cable. This connection is required to lock the XPression system to the video timing of the facility. The XPression system supports the following types of GenLock signal:

- **Analog BlackBurst** — a composite color video signal comprised of sync, color burst, and black video. Also called “color black”, “house sync” or “house black”. Typically used as the house reference synchronization signal.
- **Tri-Level Sync** — a three-level pulse synchronization signal used in high definition systems.

To transmit the GenLock signal from the XPression system, connect a GenLock signal cable to the **REF OUT BNC** connector. It is not necessary to terminate this connection if it is unused.

7. In the **AUDIO OUT** area, connect the audio output cables to the AES3id BNCs. After the XPression system is up and running, audio outputs can be assigned to each video channel.

The XPression system provides AES3id 75 ohm BNC outputs. If AES3 110 ohm connections are required, optional GearLite adaptors are available from Ross Video. For facilities requiring analog outputs, additional outboard analog to digital conversion equipment is also available from Ross Video.

8. Connect your Video Input cables to the **VIDEO IN BNC** connectors.

The XPression system provides either SDI or SDI / HD-SDI inputs. For facilities requiring analog inputs, additional outboard analog to digital conversion equipment is also available from Ross Video.

9. Connect Channel 1 Fill & Key output cables from the **SDI OUT A** and **SDI OUT C/KEY** outputs on the breakout cable to their required destination (production switcher, master control switcher, or keyer for example).

10. Connect Channel 2 Fill & Key output cables from the **SDI OUT B** and **SDI OUT D/KEY** outputs on the breakout cable to their required destination.

The XPression system provides either SDI or SDI / HD-SDI outputs. For facilities requiring analog outputs, additional outboard analog to digital conversion equipment is also available from Ross Video.

## Powering Up the System

### To power up the system:

1. Press the **Power** button to begin the boot procedure.
2. Close the front door to protect the XPression system from dust.

## Powering Down the System

Whenever the XPression system needs to be powered down, use the following procedure:

### To power down the system:

1. Log on to the XPression system using the following user name with no password:
  - **User name:** xpression
2. From the **Start** menu, select **Shut down**.

The XPression system shuts down.

# Hard Drive Maintenance

XPression utilizes a software-based RAID system in conjunction with an ICH10 chipset on the system motherboard. This setup relies on the Windows operating system and host processor to perform all of the RAID functionality.



**Warning** — Always use proper Windows shutdown procedure. NEVER HARD POWER OFF THE UNIT. Hard shutdown may cause failures in the RAID, taking one or more drives offline.

## MegaRAID Storage Manager

The MegaRAID Storage Manager is used to manage, maintain, and monitor the XPression server RAID array.

Use the following procedure to open the MegaRAID Storage Manager.

### To open the MegaRAID Storage Manager:

1. Log in to the XPression server using the following (no password):
  - **Username** — XPression
  - **Password** — (leave the password box blank)
2. In Windows, click the **Start** button and select **All Programs > MegaRAID Storage Manager > MegaRAID Storage Manager**.

The **MegaRAID Storage Manager** dialog box opens and displays the **Server Details** window.

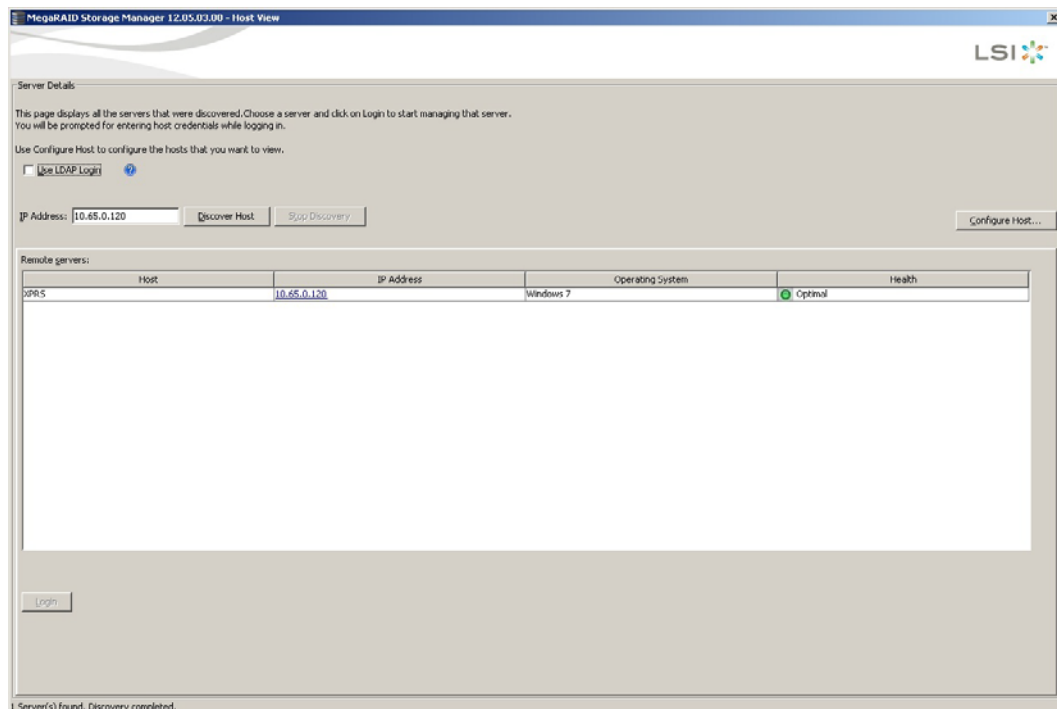

- Double-click the server under **Host** labelled **XPression**.  
The **Enter User Name & Password** dialog box opens.



- Enter the following:
  - Username** — XPression
  - Password** — (leave the password box blank)
- From the **Login Mode** list, select **Full Access**.
- Click **Login**.

The **MegaRAID Storage Manager** opens.

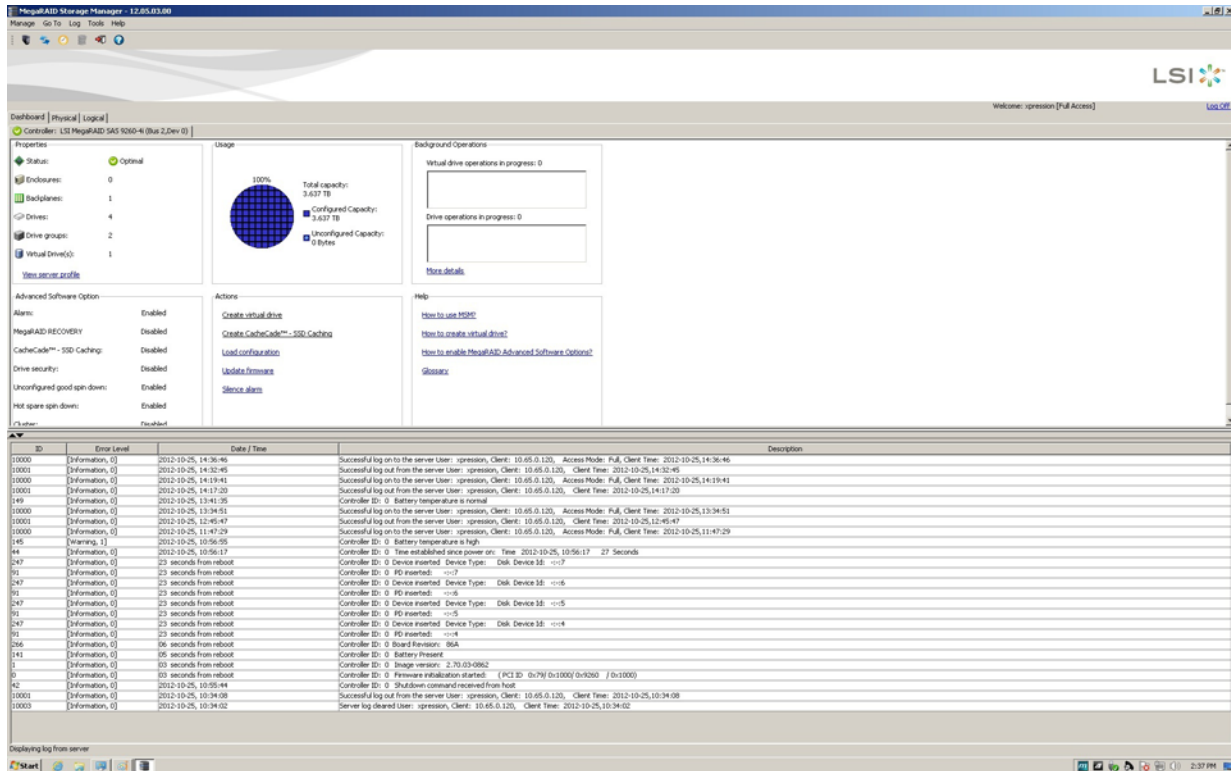

## RAID Array Consistency Check

It is important to check the XPression RAID array for consistency. Consistency checks ensure that all drives are functioning and that damaged sections are repaired. It is recommended that consistency checks are performed on a weekly basis.

- ★ Consistency checks can affect the performance of the XPression server. Consistency checks should only be performed or scheduled when XPression is not in use.

**To run a consistency check on the XPression RAID array:**

1. Open the **MegaRAID Storage Manager**.
2. In the **MegaRAID Storage Manager**, select **Manage > Check Consistency**.

The **Group Consistency Check** dialog box opens.

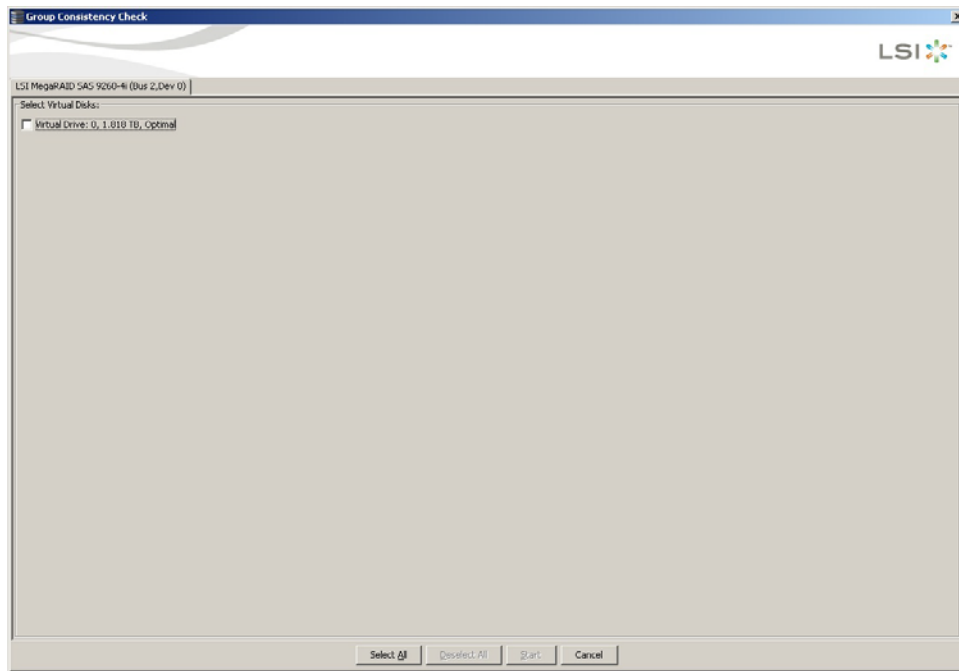

3. From the **Select Virtual Disks** section, select the check boxes of the virtual drives to check for consistency, or click the **Select All** button to select all of the virtual drives.
4. Click **Start**.

The consistency check starts.

**For More Information on...**

- opening the MegaRAID storage manager, refer to the procedure “**To open the MegaRAID Storage Manager:**” on page 3–1.

## RAID Array Drive Replacement

If a single drive fails in the XPression RAID array, the system is protected from data loss. The failed drive must be replaced as soon as possible, and the data on the failed drive must be rebuilt on a new drive to restore the system to fault tolerance.

In the MegaRAID Storage Manager, failed drives are highlighted by a red LED icon (●) displayed to the right of the drive icon. The virtual drive that uses the failed drive is highlighted by a yellow LED icon (●) displayed to the right of the virtual drive icon. The yellow LED icon indicates that the virtual drive is in a degraded state; the data is still safe, but data could be lost if another drive fails.

Rebuilding a drive also consumes bandwidth on the XPression server and is ideally done during off hours, or when the server has a low workload.

- ★ To prevent accidental data loss, backup all data before replacing a drive in the XPression RAID array.
- ★ Depending on the server workload, rebuilding a drive could take up to three hours to complete.

To rebuild a failed drive used by a virtual drive:

1. Open the **MegaRAID Storage Manager**.
2. Click the **Logical** tab.

The virtual drives contained in the XPression RAID array are listed in the **Logical** tab.

ID	Error Level	Date / Time	Description
10000	[Information, 0]	2012-10-25, 14:36:46	Successful log on to the server User: spression, Client: 10.65.0.120, Access Mode: Full, Client Time: 2012-10-25,14:36:46
10001	[Information, 0]	2012-10-25, 14:32:45	Successful log out from the server User: spression, Client: 10.65.0.120, Client Time: 2012-10-25,14:32:45
10000	[Information, 0]	2012-10-25, 14:19:41	Successful log on to the server User: spression, Client: 10.65.0.120, Access Mode: Full, Client Time: 2012-10-25,14:19:41
10001	[Information, 0]	2012-10-25, 14:17:20	Successful log out from the server User: spression, Client: 10.65.0.120, Client Time: 2012-10-25,14:17:20
149	[Information, 0]	2012-10-25, 13:41:35	Controller ID: 0, Battery temperature is normal
10000	[Information, 0]	2012-10-25, 13:34:51	Successful log on to the server User: spression, Client: 10.65.0.120, Access Mode: Full, Client Time: 2012-10-25,13:34:51
10000	[Information, 0]	2012-10-25, 12:45:47	Successful log out from the server User: spression, Client: 10.65.0.120, Client Time: 2012-10-25,12:45:47
10000	[Information, 0]	2012-10-25, 11:47:29	Successful log on to the server User: spression, Client: 10.65.0.120, Access Mode: Full, Client Time: 2012-10-25,11:47:29
145	[Warning, 1]	2012-10-25, 10:56:55	Controller ID: 0, Battery temperature is high
44	[Information, 0]	2012-10-25, 10:56:17	Controller ID: 0 Time established since power on: Time: 2012-10-25, 10:56:17 27 Seconds
247	[Information, 0]	23 seconds from reboot	Controller ID: 0 Device inserted Device Type: Disk Device ID: ---7
91	[Information, 0]	23 seconds from reboot	Controller ID: 0 FC inserted: ---7
247	[Information, 0]	23 seconds from reboot	Controller ID: 0 Device inserted Device Type: Disk Device ID: ---6
91	[Information, 0]	23 seconds from reboot	Controller ID: 0 FC inserted: ---6
247	[Information, 0]	23 seconds from reboot	Controller ID: 0 Device inserted Device Type: Disk Device ID: ---5
91	[Information, 0]	23 seconds from reboot	Controller ID: 0 FC inserted: ---5
247	[Information, 0]	23 seconds from reboot	Controller ID: 0 Device inserted Device Type: Disk Device ID: ---4
91	[Information, 0]	23 seconds from reboot	Controller ID: 0 FC inserted: ---4
247	[Information, 0]	23 seconds from reboot	Controller ID: 0 Device inserted Device Type: Disk Device ID: ---3
91	[Information, 0]	23 seconds from reboot	Controller ID: 0 FC inserted: ---3
247	[Information, 0]	23 seconds from reboot	Controller ID: 0 Device inserted Device Type: Disk Device ID: ---2
91	[Information, 0]	23 seconds from reboot	Controller ID: 0 FC inserted: ---2
247	[Information, 0]	23 seconds from reboot	Controller ID: 0 Device inserted Device Type: Disk Device ID: ---1
91	[Information, 0]	23 seconds from reboot	Controller ID: 0 FC inserted: ---1
141	[Information, 0]	05 seconds from reboot	Controller ID: 0 Board Revision: 804
1	[Information, 0]	03 seconds from reboot	Controller ID: 0 Battery Present
0	[Information, 0]	03 seconds from reboot	Controller ID: 0 Firmware initialization started: (PCI ID: 0x79 / 0x1000) / 0x1000
42	[Information, 0]	2012-10-25, 10:34:08	Controller ID: 0 Shutdown command received from host
10001	[Information, 0]	2012-10-25, 10:34:08	Successful log out from the server User: spression, Client: 10.65.0.120, Client Time: 2012-10-25,10:34:08
10003	[Information, 0]	2012-10-25, 10:34:02	Server log cleared User: spression, Client: 10.65.0.120, Client Time: 2012-10-25,10:34:02

Failed drives are highlighted by a red LED icon (●) displayed to the right of the drive icon.

3. Right-click the failed drive under the **Physical** tab and select **Start Locating Drive**.

On the front of the XPression server are two flashing red LEDs; one above the drive cage and one on a drive itself. The drive with the flashing red LED is the failed drive.

4. Remove the failed drive.
5. Insert a new replacement drive of the same size or greater. Do not use a smaller drive.

6. Locate the new drive under the **Physical** tab. The failed drive will be highlighted by a red LED icon (●) displayed to the right of the drive icon.
7. Right-click the drive and select **Change to Unconfigured Good**.

The alarm turns on.

8. Turn off the alarm.
9. Right-click the drive and select **Replace Missing Drive**.

A confirmation box opens.



10. Click **OK**.

The alarm turns on.

11. Turn off the alarm.
12. Right-click the drive and select **Start Rebuild**.

A confirmation box opens.

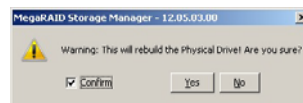

13. Select the **Confirm** check box and click **OK**.

The alarm turns on.

14. Turn off the alarm.

15. To monitor the rebuild progress, select **Manage > Show Progress**.

The **Group Show Progress** window opens.

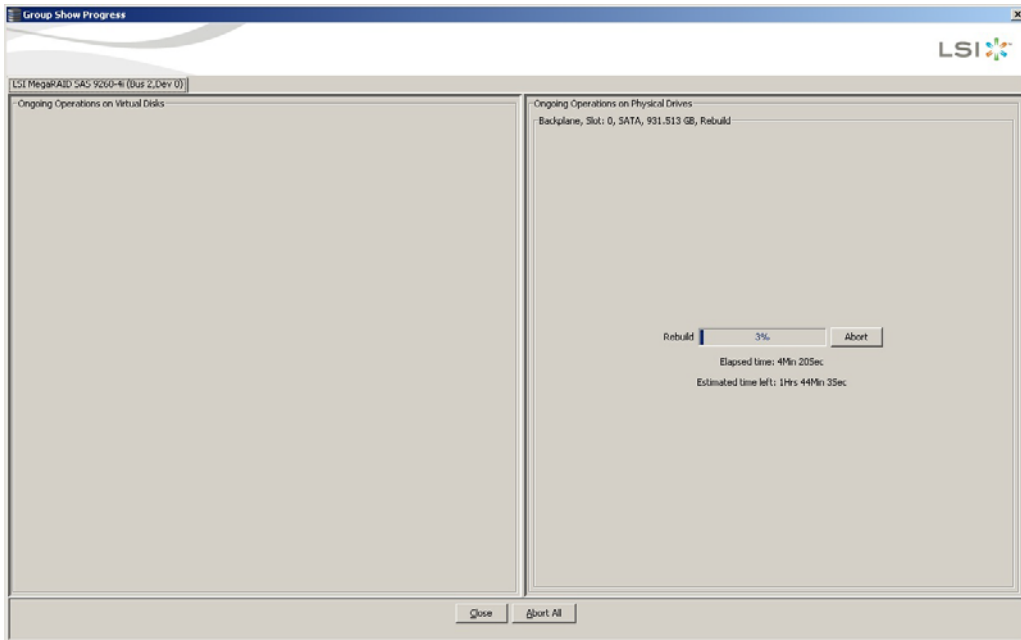

**For More Information on...**

- opening the MegaRAID storage manager, refer to the procedure **“To open the MegaRAID Storage Manager:”** on page 3-1.
- replacing a drive from the XPression server, refer to the section **“Replacing a System Drive”** on page 4-5.

# Hardware Maintenance

This chapter provides information on maintaining the XPression system.



**Caution** — *Danger of Explosion if the system lithium battery is incorrectly replaced. Replace **only** with the same or equivalent type of battery recommended by the manufacturer. Dispose of used batteries according to the manufacturer's instructions by a qualified service person.*

## Front Door Filter Maintenance

The front door on the XPression system comes equipped with two mesh filters to protect the inside of the XPression system from dust and debris.

Ross Video recommends that the following filter maintenance be performed:

- Periodically check the filter for dust and debris buildup and clean the filter.
- Replace the filter if it is damaged or worn.

### Cleaning the Front Door Filters

The mesh filter can be cleaned with a soft brush, cloth, or vacuum as needed. If the filter requires a more thorough cleaning, it can be removed from the door and washed with a mild soap and water solution.

★ The filter must be completely dry before it is reinstalled in the door.

### Removing the Front Door Filters

To remove the filters from the front door of the XPression system:

1. Open the front door of the XPression system.



2. Lift the filters from the door.



The filters can now be thoroughly cleaned.

### Re-installing the Front Door Filters

To re-install the filters in the front door of the XPression system:

1. Open the front door of the XPression system.

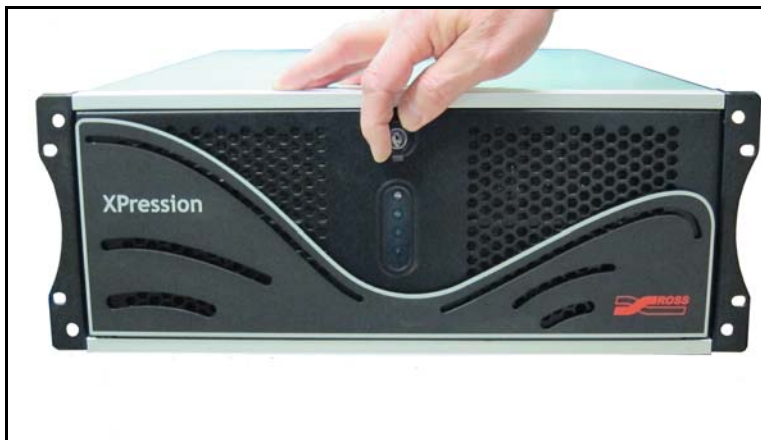

2. Insert the filters into the inside of the front door.



3. Snap the nubs on the sides of the filters into the grooves on the inside of the front door.

## Removing the Front Fan Filter

To remove the filter from the front fan of the XPression system:

1. Open the front door of the XPression system.



2. Unscrew the two thumb screws on the front fan cage.



3. Remove the front fan cage from the XPression system.



4. Remove the filter from the front fan cage.



### Re-installing the Front Fan Filter

To re-install the filter from the front fan of the XPression system:

1. Insert the filter into the front fan cage.



2. Insert the front fan cage into the front of the XPression system.



3. Tighten the two thumb screws to fasten the front fan cage to the XPression system.



## Replacing a System Drive

The XPression system drives are capable of being hot-swapped while the system is running. Keep in mind the following when hot-swapping system drives:

- Only one system drive can be removed at any time.



**Protective Earth** — *Static discharge can cause serious damage to sensitive devices. Avoid handling any hard drive in high static environments such as carpeted areas and when synthetic fiber clothing is worn. Touch the chassis to dissipate static charge before removing hard drives from the system, and exercise proper grounding precautions when working around the XPression system.*

## Removing a System Drive

To remove a system drive from the XPression system:

1. Open the front door of the XPression system.



2. On the front of the drive sled, push the blue release button up to release the black handle.



The drive sled is released from the drive bay.

3. Gently pull the drive sled out of the drive bay using the black handle. As the drive sled is pulled from the drive bay, place a hand underneath it for support.



4. Using a Phillips head screwdriver, remove the screws from the drive sled. There are four screws in total: two on each side of the drive sled.



5. Gently lift the drive off of the drive sled, placing it to one side on a flat surface.



The drive sled is now empty and ready for the installation of a new drive.

### Replacing a System Drive

To replace a system drive:

1. Insert the new drive into the sled with the with label facing upwards and the connectors at the open end of the sled.



2. Align the four screw holes on the drive with the screw holes on the sides of the sled.

3. Insert and tighten the Phillips head screws in the screw holes. There are four screws in total: two on each side of the drive sled.



The drive is now ready to be re-inserted into the XPression system.

4. Use the drive bay map below to locate the drive bay in the XPression system that matches the drive number on the drive sled being returned to the XPression system.

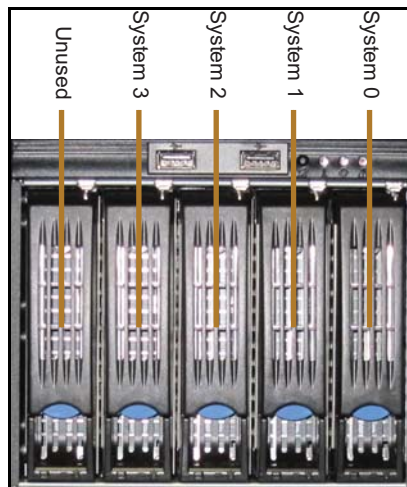

5. Align the drive sled so that the rear connector area is at the bottom of the drive sled and facing the correct drive bay for the drive sled.
6. On the front of the drive sled, push the blue release button up to release the black handle.

7. Slide the drive sled into the drive bay.



8. Push the drive sled firmly into place.



9. Close the black handle flush to the drive sled face to lock the drive into the drive bay.

The blue LED on the bottom right-hand side of the drive sled should activate to indicate that the drive is connected to the system.

**For More Information on...**

- hard drive replacement, refer to the section “Hard Drive Maintenance” on page 3-1.

## Removing and Re-Installing the Top Panel

The top panel of the XPression system can be removed to gain access to internal components such as fans, cards, and the USB security dongle.



**Caution** — *Do not operate the XPression system with the top panel removed.*

**To remove the top panel of the XPression system:**

1. Shutdown the XPression system, remove all cabling, remove the system from the equipment rack, and place the system on a flat, non-slip surface.

2. Remove the two thumbscrews at the back of the XPression system.



Set the two thumbscrews aside, as they will be needed to replace the top panel.

3. Gently pull the top panel back towards the rear of the unit, creating a gap between the top panel of the unit and the front of the chassis.



4. Lift the top panel off the chassis.



### To re-install the top panel

1. Place the top panel onto the top of the XPression system as follows:
  - Face the sides of the top panel down around the sides of the system.
  - Line up the four nubs on the inside of the sides of the top panel with the L-shaped grooves on the sides of the system.



2. Gently slide the top panel into place, until a clicking noise is heard and the top panel is flush to the front top of the XPression system.



3. Insert and tighten the two thumbscrews into the back of the XPression system.



## Replacing Cooling Fans

The XPression system has five cooling fans. There are three cooling fans in the XPression system that can be replaced if they fail:

- the front chassis fan
- the inside chassis fan
- the system drives fan

There are two fans on the CPU cooler. To replace the CPU cooler fans, please contact Ross Video Technical Support for assistance.

★ The XPression system must be shut down when replacing the cooling fans.



**Protective Earth** — *Static discharge can cause serious damage to sensitive devices. Avoid handling any hard drive in high static environments such as carpeted areas and when synthetic fiber clothing is worn. Touch the chassis to dissipate static charge before removing hard drives from the system, and exercise proper grounding precautions when working around the XPression system.*

If a fan fails, the fan failure alarm will trigger. Refer to the section “**Power LED Area**” on page 2–2 for further information on XPression system hardware alarms.

### Replacing the front chassis fan

**To remove the front chassis fan:**

1. Make sure the XPression system is shut down.
2. Remove the top panel from the XPression system. Refer to the section “**Removing and Re-Installing the Top Panel**” on page 4–9 for instructions.
3. Disconnect the front chassis fan power supply wire.

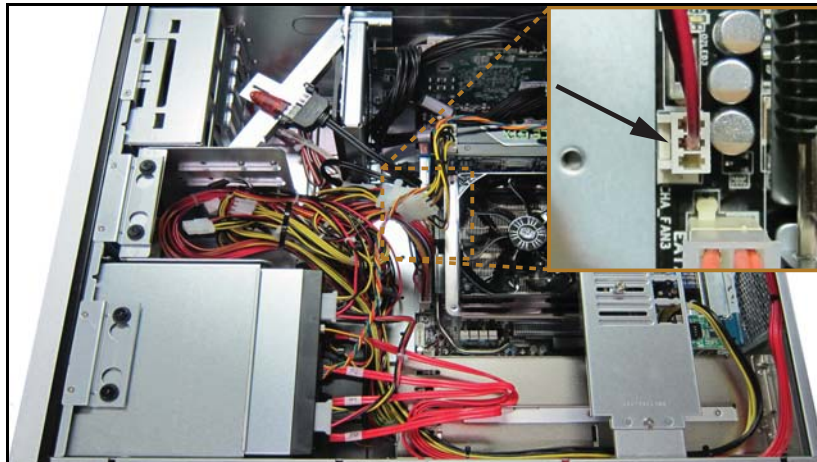

4. Open the front door of the XPression system.



5. Unscrew the two thumb screws on the front fan cage.



6. Remove the front fan cage from the XPression system.



7. Using a Phillips head screwdriver, remove the screws from the fan cage. There are four screws in total.

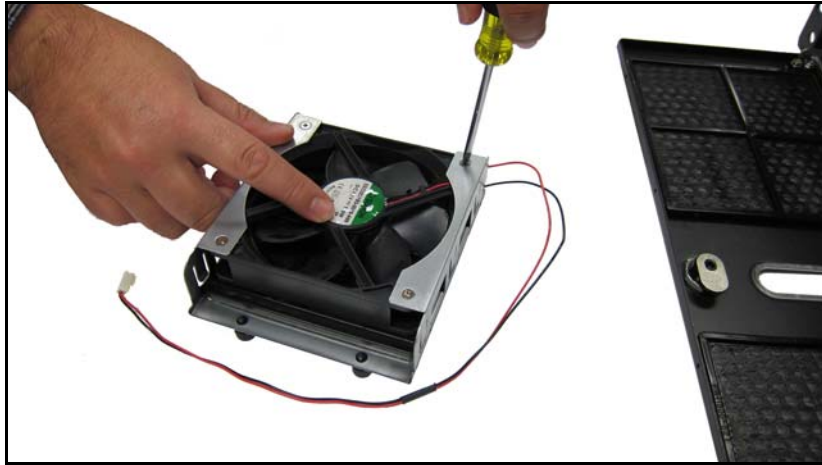

8. Remove the fan from the fan cage.

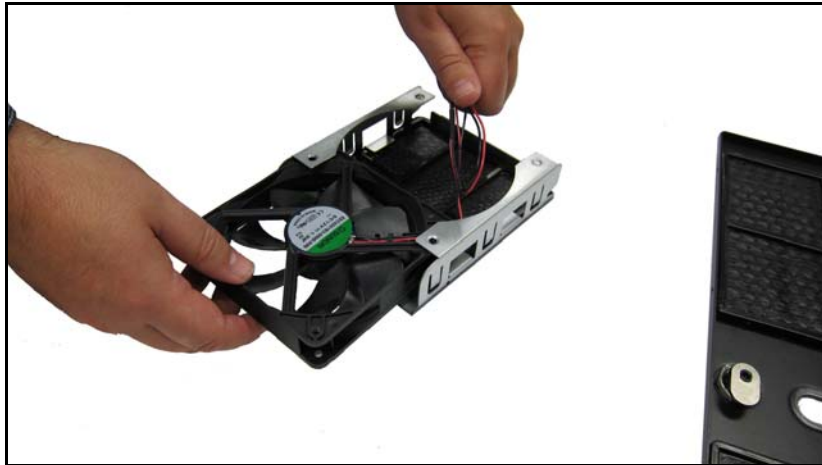

**To install the front chassis fan:**

1. Insert the new fan into the fan cage.

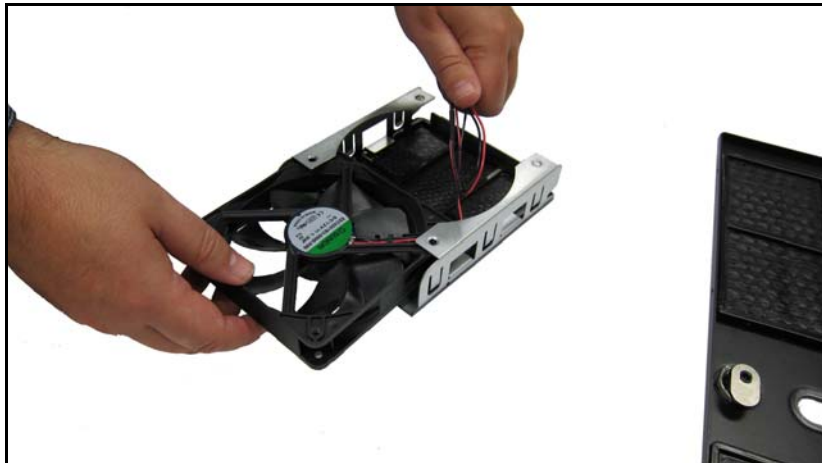

2. Insert and tighten the Phillips head screws in the screw holes. There are four screws in total.

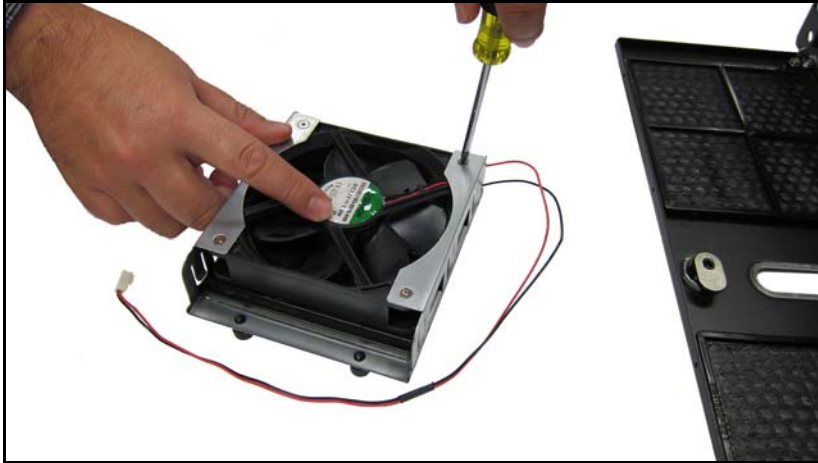

3. Insert the front fan cage in the XPression system with the fan wire inside the XPression chassis.



4. Tighten the two thumb screws on the front fan cage.



5. Close the front door of the XPression system.



6. Connect the front chassis fan power supply wire.

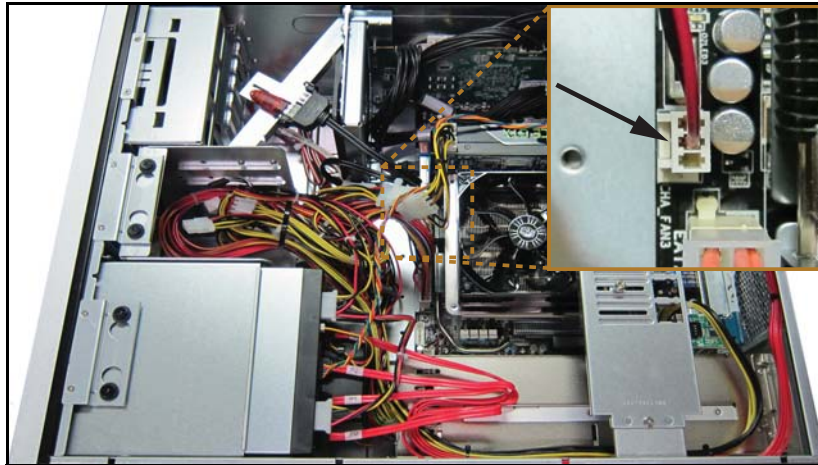

7. Replace the top panel. Refer to the section “**Removing and Re-Installing the Top Panel**” on page 4–9 for instructions.

### Replacing the Inside Chassis Fan

#### To remove the inside chassis fan:

1. Make sure the XPression system is shut down.
2. Remove the top panel from the XPression system. Refer to the section “**Removing and Re-Installing the Top Panel**” on page 4–9 for instructions.

3. Disconnect the inside chassis fan power supply wire.

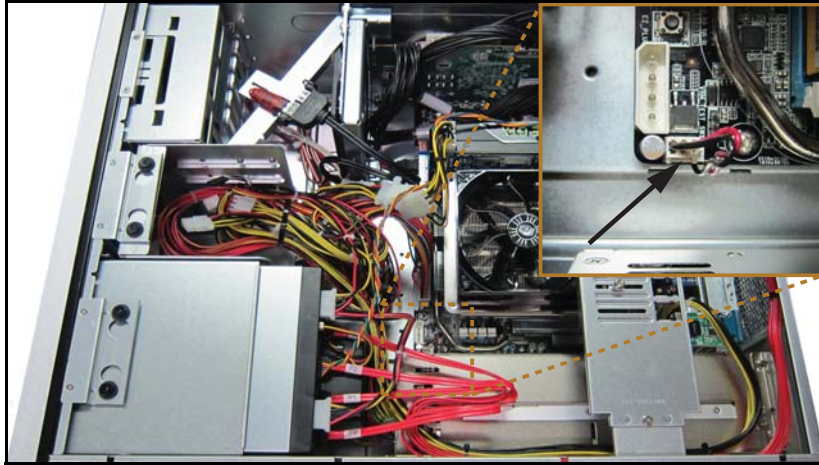

4. Using a Phillips head screwdriver, remove the screws from the fan cage. There are four screws in total.

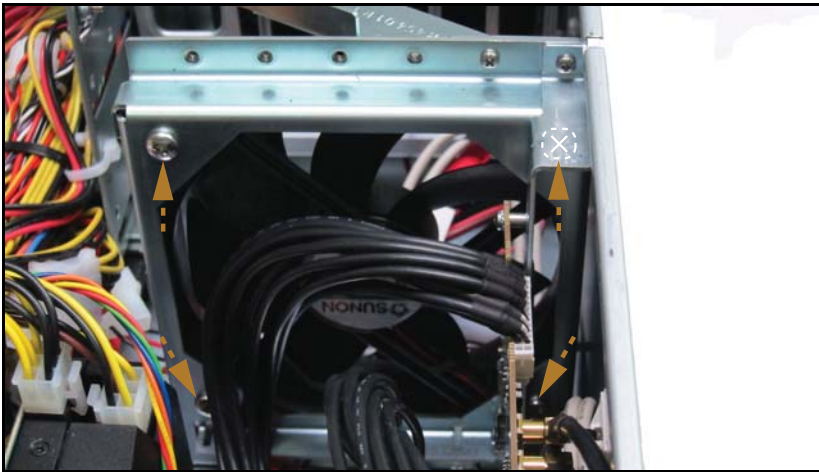

5. Remove the fan from the fan cage.

**To install the inside chassis fan:**

1. Insert the fan in the fan cage.
2. Using a Phillips head screwdriver, insert and tighten the screws in the fan cage. There are four screws in total.

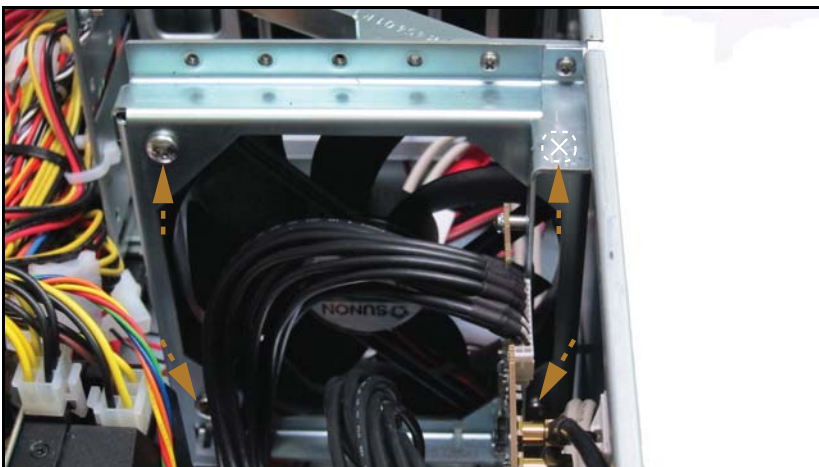

3. Connect the middle chassis fan power supply wire.

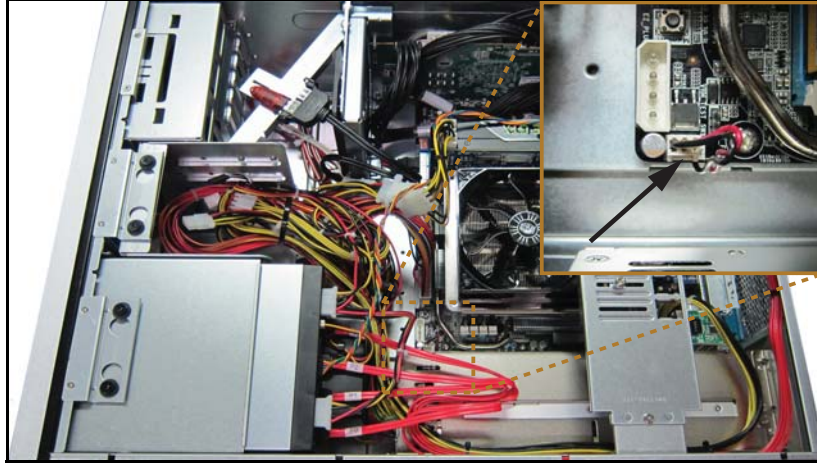

4. Replace the top panel. Refer to the section “**Removing and Re-Installing the Top Panel**” on page 4–9 for instructions.

### Replacing the System Drive Fan

#### To remove the drive cage fan:

1. Make sure the XPression system is shut down.
2. Remove the top panel from the XPression system. Refer to the section “**Removing and Re-Installing the Top Panel**” on page 4–9 for instructions.
3. Disconnect the system drive fan power supply wire.

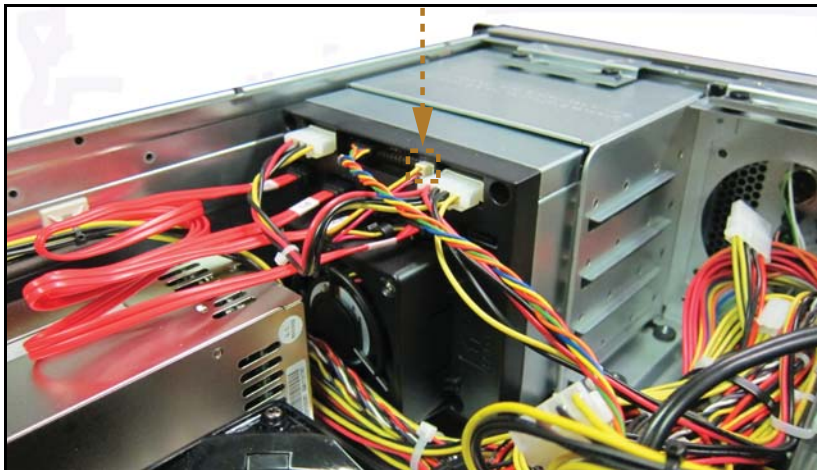

4. Squeeze the sides of the system drive fan casing.

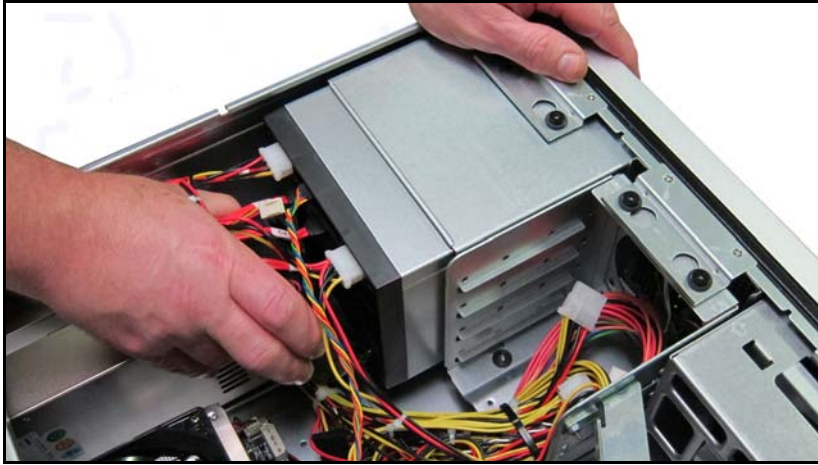

5. Remove the fan by pulling the system drive fan casing from the system drive cage.

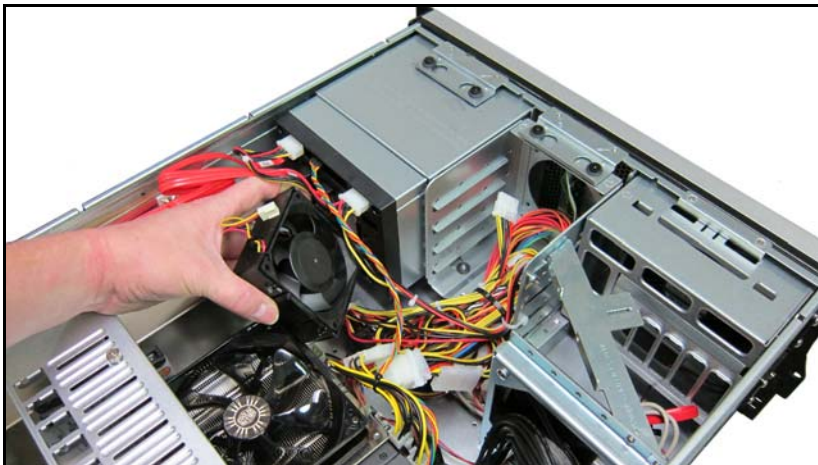

**To install the system drive fan:**

1. Attach the system drive fan to the system drive cage. The fan casing will click when the fan is secured to the system drive cage.

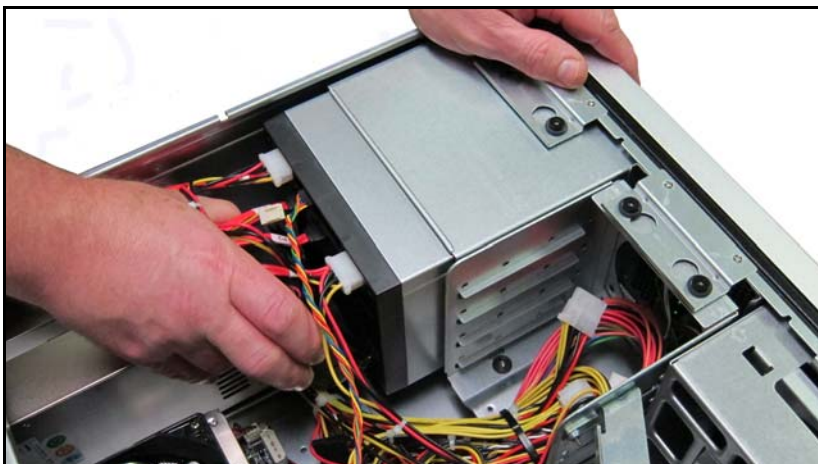

2. Connect the system drive fan power supply wire the system drive cage.

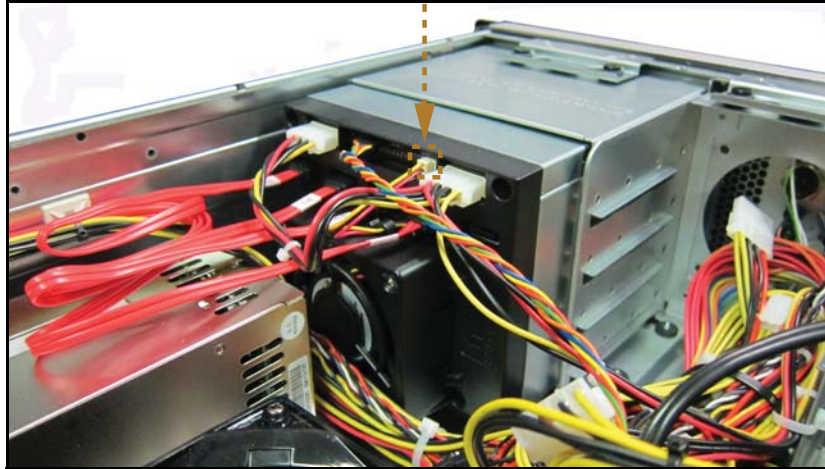

3. Replace the top panel. Refer to the section “**Removing and Re-Installing the Top Panel**” on page 4–9 for instructions.

### Accessing the USB Security Dongle

You may be required to remove or replace the USB security dongle if instructed to do so by Ross Video Technical Support.

**To access the USB security dongle:**

1. Remove the top panel from the XPression system. Refer to the section “**Removing and Re-Installing the Top Panel**” on page 4–9 for instructions.
2. The USB security dongle is located above the inside chassis fan behind the front chassis fan. The security dongle connects to the XPression system via a USB interface. Remove and replace the security dongle as instructed by Ross Video Technical Support.

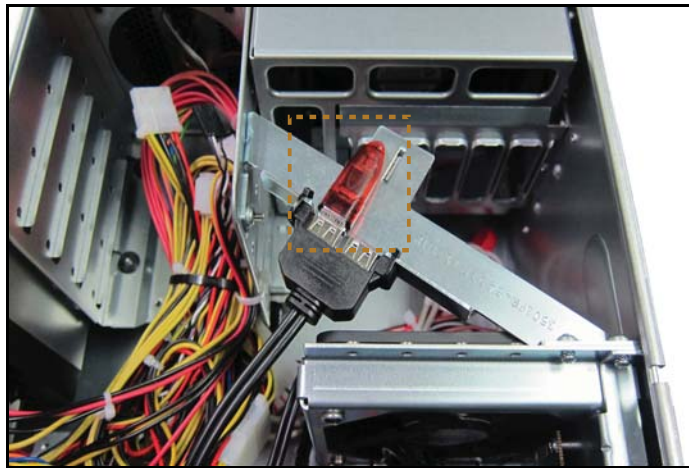

Use the additional USB interface to install an additional dongle if necessary.

3. Replace the top panel. Refer to the section “**Removing and Re-Installing the Top Panel**” on page 4–9 for instructions.

## Replacing Power Supplies

The XPression system has two identical hot-swappable power supplies, located at the rear of the system on the left-hand side. Since the system requires a minimum of one power supply to operate, one power supply can be hot-swapped at a time.



**Protective Earth** — *Static discharge can cause serious damage to sensitive devices. Touch the chassis to dissipate static charge before removing power supplies from the system, and exercise proper grounding precautions when working around the XPression system.*

Keep the following safety information in mind while removing a power supply from the XPression system:

- Always ground yourself before touching electronic equipment.
- When removing a power supply unit, always support the unit with two hands to help prevent dropping it.



**Warning Hazardous Voltages** — *Disconnect the power supply from AC mains before servicing.*

*Hazardous voltages remain within the power supply for a short period of time after removal from the system. The power supply cover is intended to protect the user from access to these areas, and should not be removed. Ross Video power supplies are intended to be factory serviced by qualified Ross Video service personnel only. Service or any component replacement is not advised.*

### Removing a Power Supply

To remove a power supply from the XPression system:

1. At the back of the XPression system, disconnect the power cord from the power supply to remove.
2. Unscrew the thumbscrew on the power supply.

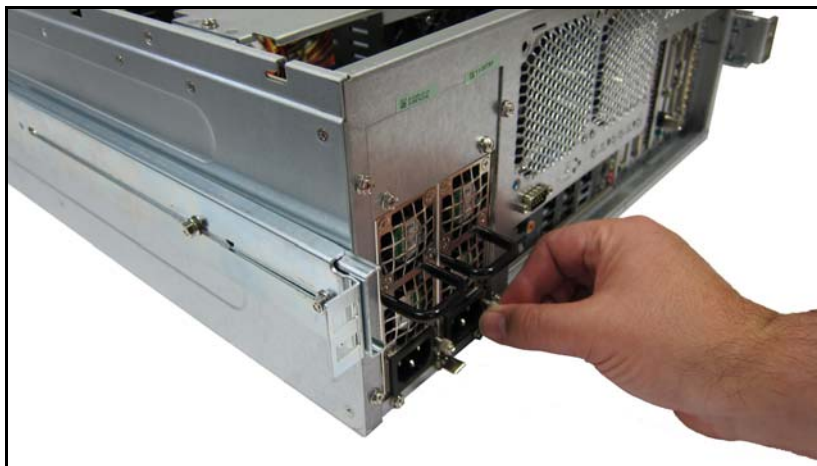

3. Holding the removal handle, gently pull on the power supply to disengage the power supply from the power supply bay.

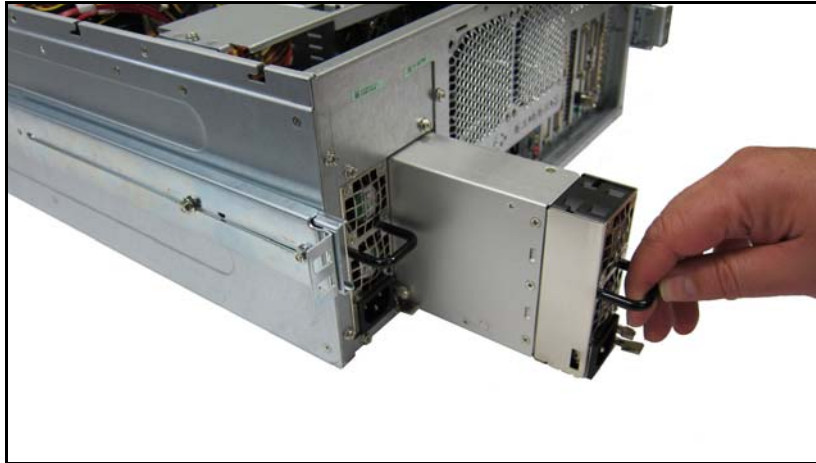

4. Support the power supply with your other hand, and continue pulling until the power supply is completely removed from the power supply bay.

### **Installing a Power Supply**

**To install a new power supply in the XPression system:**

1. In front of the open power supply bay, align the power supply so that the thumbscrew is positioned to the right-hand side.
2. Slide the power supply into the open bay and push it firmly into place.



3. Tighten the thumbscrew to secure the power supply into place.

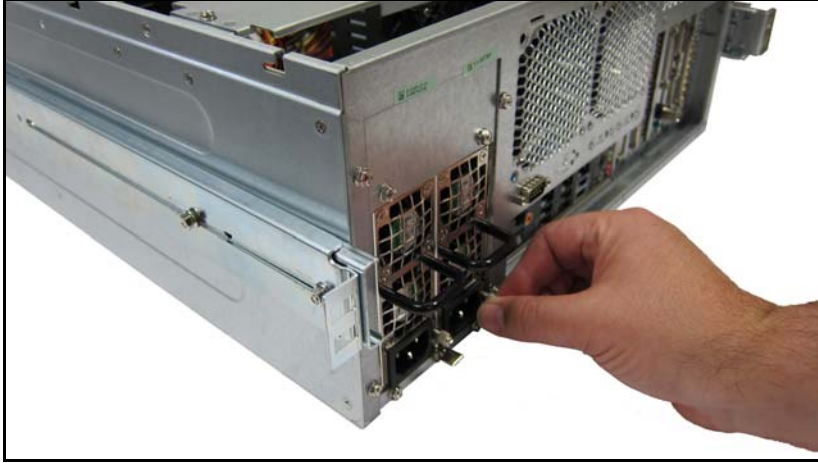

4. Connect the power cord to the new power supply.



# Appendix A: Pinouts

This appendix provides information on the GPI I/O and RS232 port pinouts.

## GPI I/O Port Pinouts

The single DB25 GPI I/O port on the back of the frame supports a total of 12 GPI Inputs and 12 GPI Outputs.

- **GPI Inputs** — Active Drive 5V TTL-compatible signal
- **GPI Outputs** — 5V TTL-compatible edge or level trigger

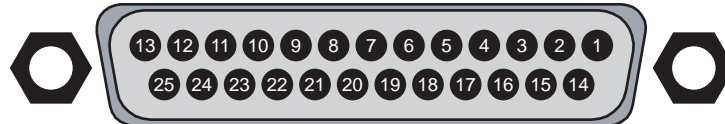

Figure A.1 GPI I/O Port — Female

Table A.1 GPI I/O Port Pinouts

Pin #	Signal
1	Ground
2	GPI In 12
3	GPI In 11
4	GPI In 10
5	GPI In 9
6	GPI In 8
7	GPI In 7
8	GPI In 6
9	GPI In 5
10	GPI In 4
11	GPI In 3
12	GPI In 2
13	GPI In 1

Pin	Signal
14	GPI Out 12
15	GPI Out 11
16	GPI Out 10
17	GPI Out 9
18	GPI Out 8
19	GPI Out 7
20	GPI Out 6
21	GPI Out 5
22	GPI Out 4
23	GPI Out 3
24	GPI Out 2
25	GPI Out 1

## RS232

XPression offers two GPI options:

- **GPI 1:** Data Set Ready pin 6 and pin 7
- **GPI 2:** Clear to Send pin 8 and pin 7

The RS232 port can also be used for CII using the XPression CII Gateway option.

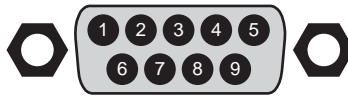

**Figure A.2** RS232 — Male

**Table A.2** RS232 Pinouts

Pin #	Signal
1	Data Carrier Detect
2	Received Data
3	Transmitted Data
4	Data Terminal Ready
5	Signal Ground

Pin	Signal
6	Data Set Ready
7	Request to Send
8	Clear to Send
9	Ring Indicator

★ When creating an RS232 GPI trigger, create a device that short-circuits either pin 8-7 or 6-7 on the nine pin female connector. No additional power can be added to the circuit or it will damage the RS232 port.

# Appendix B: Breakout Cables and Breakout Box

This appendix provides information on the breakout cable connectors and the breakout box.

## Matrox Breakout Cables

This section describes the audio and video breakout cables.

### Matrox Audio Breakout Cable

Provides 8 AES audio pairs (1/2 to 15/16). You can add a second breakout cable for AES 17/18 to AES 31/32.

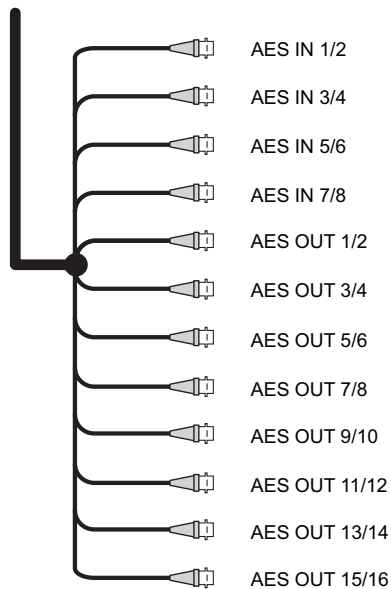

*Figure B.1 Matrox Audio Breakout Cable Connectors*

### Matrox Video Breakout Cable

Provides SDI video input and output, as well as analog reference.

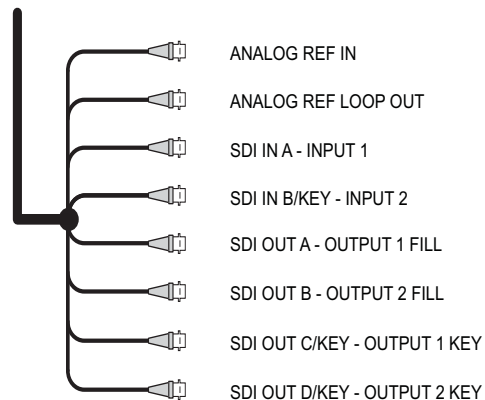

*Figure B.2 Matrox Video Breakout Cable Connectors*

## Matrox Breakout Box

Provides 16 AES audio pairs (1/2 to 31/32), SDI video input and output, and analog reference.

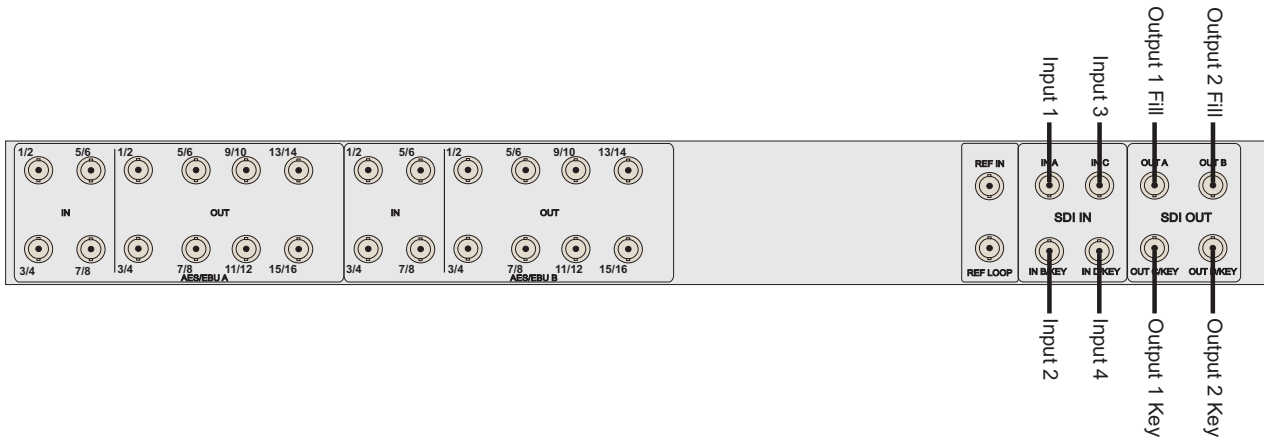

**Figure B.3** Matrox Breakout Box Connectors

The breakout box can be connected to 4-Input and 2-Channel systems.

- ★ Input 3 and Input 4 can only be used on 4-Input systems.
- ★ AES audio cable 2 can only be used on 2-Channel systems.

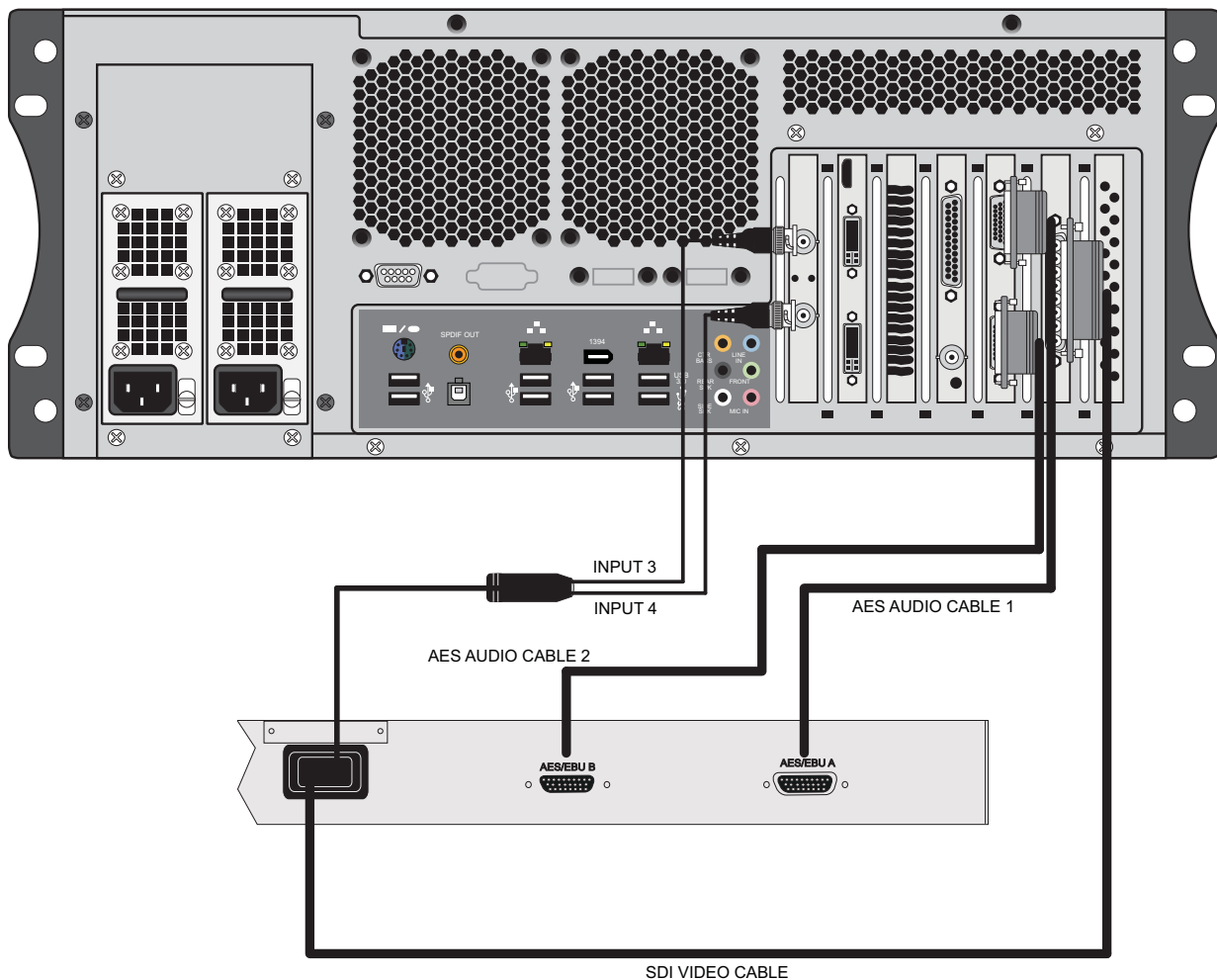

**Figure B.4** Matrox Breakout Box Cable Connections