

LUCID

User Guide

VERSION 7.3

ROSS

Thank You for Choosing Ross

You've made a great choice. We expect you will be very happy with your purchase of Ross Technology.

Our mission is to:

1. Provide a Superior Customer Experience
 - offer the best product quality and support
2. Make Cool Practical Technology
 - develop great products that customers love

Ross has become well known for the Ross Video Code of Ethics. It guides our interactions and empowers our employees. I hope you enjoy reading it below.

If anything at all with your Ross experience does not live up to your expectations be sure to reach out to us at solutions@rossvideo.com.



David Ross

CEO, Ross Video

dross@rossvideo.com

Ross Video Code of Ethics

Any company is the sum total of the people that make things happen. At Ross, our employees are a special group. Our employees truly care about doing a great job and delivering a high quality customer experience every day. This code of ethics hangs on the wall of all Ross Video locations to guide our behavior:

1. We will always act in our customers' best interest.
2. We will do our best to understand our customers' requirements.
3. We will not ship crap.
4. We will be great to work with.
5. We will do something extra for our customers, as an apology, when something big goes wrong and it's our fault.
6. We will keep our promises.
7. We will treat the competition with respect.
8. We will cooperate with and help other friendly companies.
9. We will go above and beyond in times of crisis. *If there's no one to authorize the required action in times of company or customer crisis - do what you know in your heart is right. (You may rent helicopters if necessary.)*

Lucid Studio User Guide

- Ross Part Number: 3600DR-001-7.3
- Version: 7.3
- Date/Time: 3/24/2025 11:27 AM

The information contained in this guide is subject to change without notice or obligation.

Copyright

©2025 Ross Video Limited, Ross®, and any related marks are trademarks or registered trademarks of Ross Video Limited. All other trademarks are the property of their respective companies. PATENTS ISSUED and PENDING. All rights reserved. No part of this publication may be reproduced, stored in a retrieval system, or transmitted in any form or by any means, mechanical, photocopying, recording or otherwise, without the prior written permission of Ross Video. While every precaution has been taken in the preparation of this document, Ross Video assumes no responsibility for errors or omissions. Neither is any liability assumed for damages resulting from the use of the information contained herein.

Patents

Patent numbers US 7,034,886; US 7,508,455; US 7,602,446; US 7,802,802 B2; US 7,834,886; US 7,914,332; US 8,307,284; US 8,407,374 B2; US 8,499,019 B2; US 8,519,949 B2; US 8,743,292 B2; GB 2,419,119 B; GB 2,447,380 B; and other patents pending.

Notice

The material in this manual is furnished for informational use only. It is subject to change without notice and should not be construed as commitment by Ross Video Limited. Ross Video Limited assumes no responsibility or liability for errors or inaccuracies that may appear in this manual.

End User Software License Agreement

This End User Software License Agreement is a legal agreement between you (the "Licensee") and Ross Video Limited ("Ross Video") specifying the terms and conditions of your installation and use of the Software and all Documentation (as those terms are defined herein).

IMPORTANT:

BY DOWNLOADING, ACCESSING, INSTALLING OR USING THE SOFTWARE AND/OR DOCUMENTATION AND/OR BY AUTHORIZING ANY THIRD PARTY, INCLUDING WITHOUT LIMITATION AN INSTALLER OR COMMISSIONER ACTING ON YOUR BEHALF TO DO SO, LICENSEE AGREES TO THE TERMS OF THIS AGREEMENT AND THE LICENSE GRANTED HEREUNDER SHALL BE EFFECTIVE AS OF AND FROM SUCH DATE. IF YOU DO NOT WISH TO ACCEPT THE TERMS AND CONDITIONS OF THIS AGREEMENT, DO NOT DOWNLOAD, ACCESS, INSTALL, REFER TO OR OTHERWISE USE THE SOFTWARE AND/OR DOCUMENTATION.

1. **INTERPRETATION.** In this Agreement, (a) words signifying the singular number include the plural and vice versa, and words signifying gender include all genders; (b) every use of the words "herein", "hereof", "hereto" "hereunder" and similar words shall be construed to refer to this Agreement in its entirety and not to any particular provision hereof; (c) reference to any agreement or other document herein will be construed as referring to such agreement or other document as from time to time amended, modified or supplemented (subject to any restrictions on such amendment, modification or supplement set forth therein); (d) every use of the words "including" or "includes" is to be construed as meaning "including, without limitation" or "includes, without limitation", respectively; and (e) references to an Article or a Section are to be construed as references to an Article or Section of or to this Agreement unless otherwise specified.
2. **DEFINITIONS.** In this Agreement, in addition to the terms defined elsewhere in this Agreement, the following terms have the meanings set out below:

"**Affiliate**" means, with respect to any Person, any other Person who directly or indirectly controls, is controlled by, or is under direct or indirect common control with, such Person. A Person shall be deemed to control a Person if such Person possesses, directly or indirectly, the power to direct or cause the direction of the management and policies of such Person, whether through the ownership of voting securities, by contract or otherwise; and the term "controlled" and "controlling" shall have a similar meaning.

"**Agreement**" means this End User Software License Agreement including the recitals hereto, as the same may be amended from time to time in accordance with the provisions hereof.

"**Backup System**" means the secondary piece of Designated Equipment upon which the Software is installed and mirrored for the sole purpose of replacing a Primary System in the event such Primary System is not available or functioning properly for any reason.

"**Change of Control**" means (a) the direct or indirect sale, transfer or exchange by the shareholders of a Party of more than fifty percent (50%) of the voting securities of such Party, (b) a merger or amalgamation or reorganization or other transaction to which a Party is party after which the shareholders of such Party immediately prior to such transaction hold less than fifty percent (50%) of the voting securities of the surviving entity, (c) the sale, exchange, or transfer of all or substantially all of the assets of a Party.

"Confidential Information" means all data and information relating to the business and management of either Party, including the Software, trade secrets and other technology to which access is obtained or granted hereunder by the other Party, and any materials provided by Ross Video to Licensee; provided, however, that Confidential Information shall not include any data or information which:

- (i) is or becomes publicly available through no fault of the other Party;
- (ii) is already in the rightful possession of the other Party prior to its receipt from the other Party;
- (iii) is already known to the receiving Party at the time of its disclosure to the receiving Party by the disclosing Party and is not the subject of an obligation of confidence of any kind;
- (iv) is independently developed by the other Party;
- (v) is rightfully obtained by the other Party from a third party; or
- (vi) is disclosed with the written consent of the Party whose information it is.

"Designated Equipment" shall mean (a) the hardware products sold by Ross Video to Licensee on which the Software is installed and licensed for use, as the same may be replaced from time to time by Ross Video; or (b) in the case of Software licensed on a stand-alone basis, the equipment of Licensee on which the Software is to be installed and meets the minimum specifications set out in the Documentation.

"Documentation" shall mean manuals, instruction guides, user documentation and other related materials of any kind pertaining to the Software (whether in electronic, hard-copy or other media format) that are furnished to Licensee by or on behalf of Ross Video in relation to the Software.

"Freeware" means Software that is available free of charge from Ross Video, and includes, without limitation the master control system software known as "DashBoard".

"Governmental Authority" means (a) any federal, provincial, state, local, municipal, regional, territorial, aboriginal, or other government, governmental or public department, branch, ministry, or court, domestic or foreign, including any district, agency, commission, board, arbitration panel or authority and any subdivision of any of them exercising or entitled to exercise any administrative, executive, judicial, ministerial, prerogative, legislative, regulatory, or taxing authority or power of any nature; and (b) any quasi-governmental or private body exercising any regulatory, expropriation or taxing authority under or for the account of any of them, and any subdivision of any of them.

"Improvements" means all inventions, works, discoveries, improvements and innovations of or in connection with the Software, including error corrections, bug fixes, patches and other updates in Object Code form to the extent made available to Licensee in accordance with Ross Video's release schedule.

"License Fee" means the fee(s), if any, payable in respect of the Software in accordance with the relevant invoice(s) or other purchase documents delivered in connection with this Agreement.

"License Period" means the period of time that Licensee will have the rights granted under this Agreement, as may be specified in an Order.

"Modifications" means any enhancements, changes, corrections, translations, adaptations, revisions, developments, upgrades or updates thereto; and "Modify" shall mean the creation of any of the foregoing.

"Object Code" means the machine readable executable form of a computer software program.

"Open Source Components" means third party Open Source software, libraries or other components.

"Open Source License" means the license that governs each Open Source Component.

"Order" means the documents provided by Ross Video to Licensee detailing the Ross Video products contemplated for purchase, the corresponding fees and License Period that may apply to the Software, including any and all quotations, purchase orders, acknowledgments, pro formas, invoices and other purchase documentation.

"Parties" means both Ross Video and Licensee and "Party" means either one of them as the context requires.

"Person" will be broadly interpreted and includes (a) a natural person, whether acting in his or her own capacity, or in his or her capacity as executor, administrator, estate trustee, trustee or personal or legal representative; (b) a corporation or a company of any kind, a partnership of any kind, a sole proprietorship, a trust, a joint venture, an association, an unincorporated association, an unincorporated syndicate, an unincorporated organization or any other association, organization or entity of any kind; and (c) a Governmental Authority.

"Primary System" means the Designated Equipment upon which the Software is installed and executed to deliver its intended functionality.

"Released Claims" has the meaning ascribed to it in Section 9(b).

"Released Parties" has the meaning ascribed to it in Section 9(b).

"Ross Video" means Ross Video Limited and its Affiliates.

"Software" means the version of the Object Code licensed and delivered to Licensee by Ross Video concurrently with delivery of this Agreement, including without limitation the Freeware, and any subsequent error corrections, updates, Modifications or Improvements provided to Licensee by Ross Video pursuant to this Agreement, but specifically excluding any features or plug-ins that may be purchased by you directly from third parties as upgrades or enhancements to the Software.

"Source Code" means the human readable form of a computer software program, and all tools and documentation necessary for a reasonably competent computer programmer to understand, maintain and Modify the Software.

"Third Party Software" means those portions of the Software, if any, which are owned or controlled by third parties and licensed to Ross Video pursuant to certain license agreements or arrangements with such third parties, including the Open Source Components and NDI®¹ software (<http://NDI.video>); and

"Use" means to execute, run, display, store, merge, network, Modify, translate, host or integrate with Licensee's products or other third party software.

¹ NDI® is a registered trademark of Vizrt NDI AB.

3. **LICENSE.** Subject to the terms and conditions of this Agreement, upon payment of the applicable License Fee by Licensee, or, in the case of Freeware only, upon download of the Software by Licensee onto its Designated Equipment, Ross Video hereby grants to Licensee a non-transferable and non-exclusive right to Use the Software and Documentation solely for the internal use of Licensee (the "License"), during the License Period. In the event that a License Period is not identified on the Order, such License Period shall be deemed to be perpetual, subject to paragraph 10 (c) of this Agreement. The Software shall only be used in connection with or installed on the Designated Equipment and, where applicable, shall only be used on the Primary System, provided such Primary System is operating properly."

If the Primary System is not operating properly for any reason, the Software may be used on the designated Backup System for that Primary System until such time that the Primary System begins operating properly. The Software and Documentation are provided to Licensee for the exclusive use by Licensee's organization for its ordinary business purposes and shall not be used by any third party for any purposes. Licensee may make copies of the Software as required for internal backup and archival purposes. To the extent permitted hereunder, Licensee may distribute copies of the Software and/or Documentation to members of its organization, provided (a) this Agreement is included with each copy, (b) any member of its organization who uses the Software and/or Documentation accepts and agrees to be bound by the terms of this Agreement and by any other license agreements or other agreement incorporated by reference into this Agreement, and (c) Licensee has paid any applicable additional License Fees in respect of copying and redistributing of the Software. To the extent Licensee is permitted to make copies of the Software under this Agreement, Licensee agrees to reproduce and include on any copy made or portion merged into another work, all Ross Video proprietary notices, including any notices with respect to copyrights, trademarks and this License. With the exception of copying the Software for backup or archival purposes, Licensee agrees to keep a record of the number and location of all such copies and will make such record available at Ross Video's request. The Software may include mechanisms to limit or inhibit copying.

4. **LICENSE RESTRICTIONS.** Except as otherwise provided in section 3 above, Licensee shall not: (1) copy any Software or Documentation, or part thereof, which is provided to Licensee by Ross Video pursuant to this Agreement, in Object Code form, Source Code form or other human or machine readable form, including written or printed documents, without the prior written consent of Ross Video; (2) in any way market, distribute, export, translate, transmit, merge, Modify, transfer, adapt, loan, rent, lease, assign, share, sub-license, sell, make available for download on any website or make available to another Person, the Software and/or Documentation, in whole or in part, provided that Licensee shall not be prohibited from renting or leasing the Software if Ross Video has consented, in writing, to Licensee engaging in such activities in respect of the Software; (3) reverse engineer, decompile or disassemble the Software or electronically transfer it into another computer language; or (4) use the Software or Documentation in a manner that is inconsistent with the License granted hereunder or that will result in a breach of this Agreement. Licensee agrees to take all reasonable precautions to prevent third parties from using the Software and/or Documentation in any way that would constitute a breach of this Agreement, including such precautions Licensee would ordinarily take to protect its own proprietary software, hardware or information.
5. **DELIVERY.** Ross Video shall deliver to Licensee one (1) master copy of the Software in compiled binary (executable) form suitable for reproduction in electronic files only and Ross Video shall deliver to Licensee a minimum of one copy of the Documentation.
6. **IMPROVEMENTS.** Licensee may from time to time request Ross Video to incorporate certain Improvements into the Software. Ross Video may, in its sole discretion, undertake to incorporate and provide such Improvements to Licensee with or without payment of a fee to be negotiated at the time of such request. All Improvements, whether recommended and developed by Ross Video or Licensee, shall be considered the sole property of Ross Video and shall be used by Licensee pursuant to the terms of the License granted under this Agreement.

7. **FREWARE.** Other than the obligation to pay a License Fee, which does not apply to the Freeware, all other provisions of this End User Software License Agreement apply to the Freeware in the same way as they apply to all other Software that is the subject of this Agreement. In addition, in connection with the Freeware, the following provisions apply:
 - a. Licensee will not Use the Freeware to engage in or allow others to engage in any illegal activity.
 - b. Licensee will not Use the Freeware in any way that will interfere with or damage the operation of the services of any third parties by overburdening/disabling network resources through automated queries, excessive usage or similar conduct.
 - c. Licensee will not Use the Freeware to engage in any activity that will violate the rights of others, including, without limitation, by using it for operations that involve child labour, suppressing the right of freedom of expression or endangering the security of person.
8. **OWNERSHIP.** The Parties acknowledge and agree that, as between the Parties, Ross Video shall be the owner of all intellectual property rights in the Software, Documentation and all related Modifications and Improvements, written materials, logos, trademarks, trade names, copyright, patents, trade secrets and moral rights, registered or unregistered. No proprietary interest or title in or to the intellectual property in the Software, Documentation or any Improvements or Modifications is transferred to Licensee by this Agreement. Ross Video reserves all rights not expressly licensed to Licensee under section 3.
9. **OPEN SOURCE SOFTWARE.**
 - a. Software may use and/or be provided with Open Source Components, including those detailed in the Third Party section below. To the extent stipulated by its Open Source License, each such Open Source Component is licensed directly to Licensee from its respective licensors and not sub-licensed to Licensee by Ross Video, and such Open Source Component is subject to its respective Open Source License, and not to this Agreement. If, and to the extent, an Open Source Component requires that this Agreement effectively impose, or incorporate by reference, certain disclaimers, permissions, provisions, prohibitions or restrictions, then such disclaimers, permissions, provisions, prohibitions or restrictions shall be deemed to be imposed, or incorporated by reference into this Agreement, as required, and shall supersede any conflicting provision of this Agreement, solely with respect to the corresponding Open Source Component which is governed by such Open Source License.
 - b. If Licensee, or another party on Licensee's behalf, modifies, replaces or substitutes any Open Source Component used in or provided with this Software, Licensee hereby fully, forever, irrevocably and unconditionally releases and discharges Ross Video, its Affiliates and its and their employees, officers, directors, resellers, distributors and representatives (collectively, "Released Parties") from any and all claims, charges, complaints, demands, actions, causes of action, suits, rights, debts, covenants, liabilities, warranties, performance and maintenance and support obligations (collectively, "Released Claims"), of every kind and nature, with respect to such Software, including without limitation any such Released Claims that arise as a matter of applicable Law.
 - c. If an Open Source License requires that the source code of its corresponding Open Source Component be made available to Licensee, and such source code was not delivered to Licensee with the Software, then Ross Video hereby extends a written offer, valid for the period prescribed in such Open Source License, to obtain a copy of the source code of the corresponding Open Source Component, from Ross Video from <https://www.rossvideo.com/open-source-information/>.

10. **THIRD PARTY SOFTWARE.**

- a. Licensee acknowledges that the Third Party Software is not owned by Ross Video. Notwithstanding any other provision of this Agreement, Ross Video, to the extent permitted by applicable law, offers no warranties (whether express, implied, statutory or by course of communication or dealing with Licensee, or otherwise) with respect to the Third Party Software. Ross Video may pass through to Licensee, if and to the extent permitted by applicable law, any warranties expressly provided by such third parties to Ross Video for such Third Party Software.
- b. FFmpeg Notice. The Software may utilize FFmpeg video components and their included libraries. FFmpeg is a trademark of Fabrice Bellard (originator of the FFmpeg project). Ross Video disclaims any ownership claim to FFmpeg. Please refer to <http://ffmpeg.org> (copyright is in the FFmpeg developers). FFmpeg is licensed under the GNU Lesser General Public License v2.1 or Lesser General Public License v3.0. GNU Lesser General Public License contact information: Free Software Foundation, Inc., 51 Franklin Street, Fifth Floor, Boston, MA 02110-1301 USA. Licensee can distribute it and/or modify it under the terms of such licenses.

11. **INTELLECTUAL PROPERTY INDEMNITY.**

- a. Ross Video agrees to defend, indemnify and hold harmless Licensee from final damages awarded by a court of competent jurisdiction (hereinafter referred to as the "**Losses**"), which Licensee, or any of its officers or directors, may incur, suffer or become liable for as a result of, or in connection with, any third party claim asserted against Licensee to the extent such claim is based on a contention that the Software, Documentation or any portion thereof, infringes any valid, registered, enforceable patents, copyrights, trade secrets, trademarks or other intellectual property rights of any third party, provided that (a) the allegedly infringing Software or Documentation has been used within the scope of and in accordance with the terms of this Agreement, and (b) Licensee notifies Ross Video in writing of such claim within ten (10) days of a responsible officer of Licensee becoming aware of such claim. If the Software, Documentation or any portion thereof is held to constitute an infringement of a third party's intellectual property rights, and use thereof is enjoined, Ross Video shall, at its election and expense, either (i) procure the right to use the infringing element of the Software or Documentation; or (ii) replace or modify the element of the Software or Documentation so that the infringing portion is no longer infringing and still performs the same function without any material loss of functionality. Ross Video shall make every reasonable effort to correct the situation with minimal effect upon the operations of Licensee.
- b. Notwithstanding the above, Ross Video reserves the right to terminate this Agreement and the License granted hereunder on immediate notice to Licensee, and without liability to Licensee, in the event that the Software or Documentation constitutes or may, in Ross Video's determination, constitute, an infringement of the rights of a third party that Ross Video, in its sole discretion, does not consider to be affordably remediable.
- c. Either party may terminate this Agreement immediately should any Software become, or in either party's opinion be likely to become, the subject of a claim of infringement of any intellectual property right and, in such event, there shall be no claim by either Licensee or Ross Video against the other arising out of such termination, provided that the foregoing shall not apply to a claim for infringement by Ross Video against Licensee in the event that Licensee is alleged to have infringed Ross Video's intellectual property rights, in which case Licensee shall remain liable for all outstanding License Fees and other amounts owing to Ross Video.
- d. Notwithstanding the foregoing, Ross Video shall have no liability for any claim of infringement based on use of other than a current, unaltered release of the Software and/or Documentation available from Ross Video if such infringement would have been avoided by the use of a current, unaltered release of the Software and/or Documentation provided that such current, unaltered release performs substantially in conformity with the specifications set out in the Documentation and was provided, at no additional cost by Ross Video, to those subscribing for maintenance services for the Software or Documentation.

12. **CONFIDENTIALITY.** Each Party shall maintain in confidence all Confidential Information of the other Party, shall use such Confidential Information only for the purpose of exercising its rights and fulfilling its obligations under this Agreement, and shall not disclose any Confidential Information of the disclosing Party to any third party except as expressly permitted hereunder or make any unauthorized use thereof. Each Party shall disclose the Confidential Information only to those of its employees, consultants, advisors, and/or subcontractors who have a need to know the Confidential Information. Each Party shall, prior to disclosing the Confidential Information to such employees, consultants, advisors and/or subcontractors, obtain their agreement to receive and use the Confidential Information on a confidential basis on the same terms and conditions contained in this Agreement. The receiving Party shall treat the Confidential Information of the disclosing Party with the same degree of care against disclosure and/or unauthorized use as it affords to its own information of a similar nature, or a reasonable degree of care, whichever is greater. The receiving Party further agrees not to remove or destroy any proprietary or confidential legends or markings placed upon any documents or other materials of the disclosing Party. The obligations of confidence set forth in this Agreement shall extend to any Affiliates that have received Confidential Information of the disclosing Party and shall also cover Confidential Information disclosed by any Affiliate. The receiving Party shall be responsible for any actions or omissions of its Affiliates as if such actions or omissions were its own.

Either party may disclose certain Confidential Information if it is expressly required to do so pursuant to legal, judicial, or administrative proceedings, or otherwise required by law, provided that (i) such Party provides the other Party with reasonable written notice prior to such disclosure; (ii) such Party seeks confidential treatment for such Confidential Information; (iii) the extent of such disclosure is only to the extent expressly required by law or under the applicable court order; and (iv) such Party complies with any applicable protective or equivalent order.

Each of Ross Video and Licensee (the "**Indemnifying Party**", as applicable) agree to indemnify the other (the "**Indemnified Party**", as applicable) for all Losses incurred by the Indemnified Party as a result of a failure of the Indemnifying Party to comply with its obligations under this Section 12 provided that the Indemnified Party has given prompt notice of any such claim and, to the extent that a claim may lie against a third party for the unauthorized disclosure of such Confidential Information, the right to control and direct the investigation, preparation, action and settlement of each such claim and, further, provided that the Indemnified Party reasonably co-operates with the Indemnifying Party in connection with the foregoing and provides the Indemnifying Party with all information in the Indemnified Party's possession related to such claim and such further assistance as reasonably requested by the Indemnifying Party.

The Parties acknowledge and agree that any breach of the confidentiality provisions of this Agreement by one Party may cause significant and irreparable injury to the other Party that is not compensable monetarily, as well as damages that may be difficult to ascertain, and agrees that, in addition to such other remedies that may be available at law or in equity, the other Party shall be entitled to seek injunctive relief (including temporary restraining orders, interim injunctions and permanent injunctions) in a court of competent jurisdiction in the event of the breach or threatened breach by such party of any of the confidentiality provisions of this Agreement. The relief contemplated in this Section shall be available to each Party without the necessity of having to prove actual damages and without the necessity of having to post any bond or other security. Each Party further agrees to notify the other Party in the event that it learns of or has reason to believe that any Person has breached the confidentiality provisions of this Agreement.

13. **LIMITATION OF LIABILITY.** The limitation of liability provisions of this Agreement reflect an informed voluntary allocation of the risks (known and unknown) that may exist in connection with the licensing of the Software or Documentation hereunder by Ross Video, and that voluntary risk allocation represents a material part of the Agreement reached between Ross Video and Licensee. Should Ross Video be in breach of any obligation, Licensee agrees that Licensee's remedies will be limited to those set forth in this Agreement. No action, regardless of form, arising out of this Agreement may be brought by Licensee more than twelve (12) months after the facts giving rise to the cause of action have occurred, regardless of whether those facts by that time are known to, or reasonably ought to have been discovered by, Licensee.

(A) EXCEPT AS EXPRESSLY PROVIDED IN THIS AGREEMENT, THE SOFTWARE AND DOCUMENTATION ARE PROVIDED "AS IS" AND ROSS VIDEO (I) MAKES NO OTHER REPRESENTATIONS, AND PROVIDES NO WARRANTIES OR CONDITIONS OF ANY KIND, EXPRESS OR IMPLIED, STATUTORY, BY USAGE OF TRADE CUSTOM OF DEALING, OR OTHERWISE, AND (II) SPECIFICALLY DISCLAIMS ALL IMPLIED WARRANTIES INCLUDING ANY IMPLIED WARRANTY OF UNINTERRUPTED OR ERROR FREE OPERATION, MERCHANTABILITY, QUALITY OR FITNESS FOR A PARTICULAR PURPOSE. ROSS VIDEO DOES NOT REPRESENT OR WARRANT THAT THE SOFTWARE WILL MEET ANY OR ALL OF LICENSEE'S PARTICULAR REQUIREMENTS, THAT THE USE AND OPERATION OF THE SOFTWARE WILL OPERATE ERROR-FREE OR UNINTERRUPTED, THAT ALL PROGRAMMING ERRORS IN THE SOFTWARE CAN BE FOUND IN ORDER TO BE CORRECTED, OR THAT THE SOFTWARE WILL BE COMPATIBLE WITH OTHER PROGRAMS, SYSTEMS, AND HARDWARE.

(B) IN NO EVENT SHALL ROSS VIDEO, ITS AFFILIATES AND LICENSORS, AND THEIR RESPECTIVE DIRECTORS, OFFICERS, EMPLOYEES AND AGENTS, BE LIABLE FOR ANY CLAIM FOR INDIRECT, CONSEQUENTIAL, SPECIAL, INCIDENTAL, PUNITIVE, EXEMPLARY, AGGRAVATED DAMAGES; LOST PROFITS, OR LOST REVENUE ARISING FROM OR IN CONNECTION WITH THIS AGREEMENT, REGARDLESS OF THE FORM OF ACTION, WHETHER IN CONTRACT, OR IN TORT, EVEN IF THE PARTY HAS BEEN ADVISED OF THE POSSIBILITY OF SUCH DAMAGES.

(C) IN ANY EVENT THE AGGREGATE LIABILITY OF ROSS VIDEO, ITS AFFILIATES AND LICENSORS, AND THEIR RESPECTIVE DIRECTORS, OFFICERS, EMPLOYEES AND AGENTS, FOR ANY CLAIM FOR DIRECT DAMAGES WITH RESPECT TO THE SUBJECT MATTER OF THIS AGREEMENT SHALL NOT EXCEED THE AMOUNT OF THE PURCHASE PRICE PAID TO ROSS VIDEO UNDER THIS AGREEMENT.

14. **TERM AND TERMINATION.**

- (1) Unless terminated earlier in accordance with the terms of this Agreement, the term of this Agreement shall commence upon Licensee's first download, access, installation, or other use of the Software or Documentation and continues until, in the case of Software licensed with Designated Equipment provided by Ross Video, the earliest of (a) the end of the License Period, or (b) if the Designated Equipment is assigned or transferred in accordance with this Agreement, the date on which the Designated Equipment is no longer owned by Licensee;
- (2) Either Party shall have the right to terminate this Agreement on notice to the other Party if:
 - (a) the other Party fails to pay any fees or other amounts when due hereunder or under any other agreement between the Parties (or any Affiliates of the Parties, as applicable) in connection with the Software and/or Designated Equipment and such breach is not cured within thirty (30) days after written notice of such failure to pay is given to the defaulting Party by the non-defaulting Party;
 - (b) the other Party shall file a voluntary petition in bankruptcy or insolvency or shall petition for reorganization under any bankruptcy law, consent to an involuntary petition in bankruptcy, or if a receiving order is given against it under the Bankruptcy and Insolvency Act (Canada) or the comparable law of any other jurisdiction (and such is not dismissed within ten (10) days);

- (c) there shall be entered an order, judgment or decree by a court of competent jurisdiction, upon the application of a creditor, approving a petition seeking reorganization or appointing a receiver, trustee or liquidator of all or a substantial part of the other Party's assets and such order, judgment or decree continues in effect for a period of thirty (30) consecutive days; or
- (d) the other Party shall fail to perform any of the other material obligations set forth in this Agreement and such default, in the case of a default which is remediable, continues for a period of thirty (30) days after written notice of such failure has been given by the non-defaulting Party or, in the case of a non-remediable default, immediately upon notice.

(3) Notwithstanding anything to the contrary contained in this Agreement:

- (a) Ross Video may forthwith terminate this Agreement if Licensee is in breach of any of sections 3, 4 or 12 of this Agreement. For greater certainty, in such instances Ross Video shall provide written notice of such termination as soon as practicable but written notice shall not be a necessary prerequisite to such termination; and
- (b) in the event of a Change of Control of Licensee, Ross Video shall have the right to terminate this Agreement and the License granted hereunder upon thirty (30) days' prior written notice to Licensee. For greater certainty, Ross Video's right to terminate in the event of a Change of Control of Licensee shall continue for a period of six (6) months from the date Licensee delivers notice of such Change of Control to Ross Video.
- (c) Ross Video may terminate the License immediately on the date on which it provides notice to Licensee, if its agreements for Third Party Software are terminated.

(4) Upon the termination or expiry of this Agreement:

- (a) Licensee shall immediately cease and desist all use of the Software and Documentation;
- (b) Licensee shall immediately deliver to Ross Video any of Ross Video's Confidential Information provided hereunder (including the Software and Documentation) then in its possession or control, if any, and shall deliver a certificate of an officer of Licensee certifying the completeness of same;
- (c) Licensee shall refrain from further use of such Confidential Information; and
- (d) Licensee shall forthwith pay all amounts owing to Ross Video or any of its Affiliates hereunder.

15. **SURVIVAL.** The provisions of sections 1, 2, 6, 8, 9, 10, 11, 12, 13, 14, 18, 22, 23, and 24 herein shall survive the expiry or termination of this Agreement.
16. **FORCE MAJEURE.** Dates and times by which Ross Video is required to render performance under this Agreement shall be automatically postponed to the extent and for the period that Ross Video is prevented from meeting them by reason of events of force majeure or any cause beyond its reasonable control provided Ross Video notifies Licensee of the commencement and nature of such cause and uses its reasonable efforts to render performance in a timely manner.
17. **ASSIGNMENT.** Ross Video may assign this Agreement, or any of its rights or obligations hereunder, in whole or in part, upon notice to Licensee. Licensee shall not assign this Agreement, or any of its rights or obligations hereunder, in whole or in part, without the prior written consent of Ross Video, which consent may not be unreasonably withheld. This Agreement enures to the benefit of and is binding upon each of the Parties and their respective successors and permitted assigns.

18. **GOVERNING LAW.** If Licensee acquired the Ross Product(s) in the United States or Canada, the laws of the state or province where Licensee's principal place of business is located govern the interpretation of this Agreement, claims for its breach, and all other claims regardless of conflict of laws principles. If Licensee acquired the Ross Product(s) in the European Union or the United Kingdom, then the laws of England and Wales apply. If Licensee acquired the Ross Product(s) in any other country, then the laws of the Province of Ontario, Canada shall apply.
19. **LANGUAGE.** The Parties have expressly required that this Agreement and all documents relating thereto be prepared in English. Les parties ont expressément exigé que cette convention ainsi que tous les documents qui s'y rattachent soient rédigés en anglais.
20. **GOVERNMENT CONTRACTS.** If the Software and/or Documentation to be furnished to Licensee hereunder are to be used in the performance of a government contract or subcontract, the Software and/or Documentation shall be provided on a "restricted rights" basis only and Licensee shall place a legend, in addition to applicable copyright notices, in the form provided under the applicable governmental regulations. For greater certainty, Ross Video shall not be subject to any flow-down provisions required by any customer of Licensee that is a Governmental Authority unless Ross Video expressly agrees to be bound by such flow-down provisions in writing.
21. **EXPORT AND IMPORT LAWS.** Licensee acknowledges and agrees that the Software (including any technical data and related technology) may be subject to the export control laws, rules, regulations, restrictions and national security controls of the United States and other applicable countries (the "**Export Controls**") and agrees not to export, re-export, import or allow the export, re-export or import of such export-controlled Software (including any technical data and related technology) or any copy, portion or direct product of the foregoing in violation of the Export Controls. Licensee hereby represents that it is not an entity or person to whom provision of the Software (including any technical data and related technology) is restricted or prohibited by the Export Controls. Licensee agrees that it has the sole responsibility to obtain any authorization to export, re-export, or import the Software (including any technical data and related technology), as may be required. Licensee will defend, indemnify and hold Ross Video harmless from any and all claims, losses, liabilities, damages, fines, penalties, costs and expenses (including attorney's fees) arising from or relating to any breach by Licensee of its obligations under this Section.
22. **AMENDMENT AND WAIVER.** No amendment, discharge, modification, restatement, supplement, termination or waiver of this Agreement or any Section of this Agreement is binding unless it is in writing and executed by the Party to be bound. No waiver of, failure to exercise or delay in exercising, any Section of this Agreement constitutes a waiver of any other Section (whether or not similar) nor does any waiver constitute a continuing waiver unless otherwise expressly provided.
23. **SEVERABILITY.** Each Section of this Agreement is distinct and severable. If any Section of this Agreement, in whole or in part, is or becomes illegal, invalid, void, voidable or unenforceable in any jurisdiction by any court of competent jurisdiction, the illegality, invalidity or unenforceability of that Section, in whole or in part, will not affect (a) the legality, validity or enforceability of the remaining Sections of this Agreement, in whole or in part; or (b) the legality, validity or enforceability of that Section, in whole or in part, in any other jurisdiction.
24. **ENTIRE AGREEMENT.** This Agreement, and any other documents referred to herein, constitutes the entire agreement between the Parties relating to the subject matter of this Agreement and supersedes all prior written or oral agreements, representations and other communications between the Parties.

Updated: November 1, 2023

Warranty and Repair Policy

Ross Video Limited (Ross) warrants its Lucid Studio systems to be free from defects under normal use and service for the following time periods from the date of shipment:

- Lucid Studio Server — 12 months
- Lucid Studio Software Upgrades — 12 months free of charge
- System and Media hard drives — 12 months

If an item becomes defective within the warranty period Ross will repair or replace the defective item, as determined solely by Ross.

Warranty repairs will be conducted at Ross, with all shipping FOB Ross dock. If repairs are conducted at the customer site, reasonable out-of-pocket charges will apply. At the discretion of Ross, and on a temporary loan basis, plug in circuit boards or other replacement parts may be supplied free of charge while defective items undergo repair. Return packing, shipping, and special handling costs are the responsibility of the customer.

This warranty is void if products are subjected to misuse, neglect, accident, improper installation or application, or unauthorized modification.

In no event shall Ross Video Limited be liable for direct, indirect, special, incidental, or consequential damages (including loss of profit). Implied warranties, including that of merchantability and fitness for a particular purpose, are expressly limited to the duration of this warranty.

This warranty is TRANSFERABLE to subsequent owners, subject to Ross' notification of change of ownership.

Extended Warranty

For customers that require a longer warranty period, Ross offers an extended warranty plan to extend the standard warranty period by one year increments. For more information about an extended warranty for your Lucid Studio system, contact your regional sales manager.

Environmental Information

The equipment that you purchased required the extraction and use of natural resources for its production. It may contain hazardous substances that could impact health and the environment.

To avoid the potential release of those substances into the environment and to diminish the need for the extraction of natural resources, Ross Video encourages you to use the appropriate take-back systems. These systems will reuse or recycle most of the materials from your end-of-life equipment in an environmentally friendly and health conscious manner.

The crossed-out wheeled bin symbol invites you to use these systems.



If you need more information on the collection, reuse, and recycling systems, please contact your local or regional waste administration.

You can also contact Ross Video for more information on the environmental performances of our products.

Company Address

Ross Video Limited

8 John Street
Iroquois, Ontario
Canada, K0E 1K0

Ross Video Incorporated

P.O. Box 880
Ogdensburg, New York
USA 13669-0880

General Business Office: (+1) 613 · 652 · 4886

Fax: (+1) 613 · 652 · 4425

Toll Free Technical Support: 1-844-652-0645 (North America)
+800 3540 3545 (International)

Alternately, you can contact:

Technical Support: (+1) 613 · 652 · 4886

After Hours Emergency: (+1) 613 · 349 · 0006

E-mail for Technical Support: techsupport@rossvideo.com

E-mail for General Information: solutions@rossvideo.com

Website: <http://www.rossvideo.com>

Contents

What's New?	22
Introduction	24
About This Guide	26
Getting Help	28
Installation Notes	29
Advanced User Options	34
Lucid Track	35
Launching Lucid Track on Custom Hardware	36
Exploring the Lucid Track User Interface	37
Setup	39
Track	40
Lucid	42
Users	44
About	47
Panels	48
Track Setup	49
Calibration	50
Camera	52
Tracking Parameters	53
Tracking Calibration	55
Lens Information	60
Track Operate	63
Offsets	63
Defocus	64
Floor Position Fields	65
Floor Presets	66
Track Grid	68
Track Stats	71
Log	72
Customizing and Managing Layouts	73
Customizing Layouts	73
Managing Layouts	75

Lucid Studio	76
Setup	79
Lucid	80
Files	83
Ross	86
DashBoard	87
Streamline	90
DataLinq	92
WebAPI	93
Stream Deck	95
Installing the Lucid Plugin for Stream Deck	95
Adding Lucid Events to Stream Deck	96
Creating a Stream Deck Profile	99
Adding an Image to a Key	100
Editing Lucid Event Titles	102
Users	103
About	106
Customizing and Managing Layouts	107
Customizing Layouts	107
Managing Layouts	109
Server	110
Server	111
Renderers Groups	118
Remote	121
Renderer Service	123
Track Setup	125
Calibration	126
Camera	128
Tracking Parameters	129
Tracking Calibration	131
Lens Information	136
Track Operate	139
Garbage Mattes	140
Offsets	145
Defocus	146
Floor Presets	149
Track Grid	152
Studio Setup	153
Track	153
Grid	153
Position	154
Position Panel Components	155
Managing Items in the Position Panel	160

Events	171
Event Page Navigation	172
Event Page Editing	173
Event Editing	175
General Tab	176
Actions Tab	179
Event	181
Router	182
Position	185
Floor	187
G.Mattes	188
Animation	189
Renderer	190
Pause	192
Sequencer	193
Logic	194
Send	195
Robotics	197
Chroma	199
Color Correction	200
Video Walls	201
Script	202
Misc	203
Sequencer	205
Lucid Event Sequences	206
MOS Story Sequences	213
Router	216
Sources	217
Materials	220
Targets	222
Groups	225
Presets	226
No Updates/Updates	227
Logic	228
Using Visual Logic	229
Function Blocks	235
Boolean	237
Communications	242
File	244
Lucid	245
Math	252
Math - Trig	260
Math - Vector	263
Parsers	268
Python	270
Renderer	271
String	273
Tracking	278

Utilities	282
Web	298
Chroma	301
Presets	305
Color Correction	307
Video Walls	312
Log	314
EndPoints	315
User Input Control	318
Selecting a List Type	319
Creating or Importing a Static List	321
Creating or Importing a Global List	325
Creating a List Using a DataLinq Source	332
Exporting a Static or Global List	334
Editing a List	336
Lucid Driver for XPression	342
Settings	344
XPression	346
Log	348
About	349
RVS Engine Service	350
Settings	351
Log	354
About	355
Lucid MOS Service	356
Settings	357
MOS	358
Log	359
About	360
Lucid Studio and DashBoard	361
Events	362
Position	363
Creating a Custom DashBoard Panel	364
Lucid Studio and Voyager	367
Configuring the Lucid Plugin in Voyager	368
Using Voyager Blueprints with Lucid Studio Logic	371

Using the Send Message Node	375
Using Lucid Studio to Control a Voyager Multiple Display System	376
Starting a Voyager nDisplay Project from Lucid Studio	377
Starting Switchboard Listener	383
XPression Gateway Setup	389
Glossary of Terms	396
Appendix A: Supported Lenses, Mounts and Protocols	400
Lucid Studio 7.3 Compatible Lenses	401
Lucid Studio 7.3 Compatible Camera Mounts	403
Lucid Studio 7.3 Compatible Tracking Protocols	404
Appendix B: Testing SLP	405

What's New?

The following improvements were added in Lucid Studio 7.3.

- Duplicate Internal Names notification and handling.
 - [Files](#)
- RossTalk Message ID saved.
 - [General Tab](#)
- Published Field and Field Name properties remain visible in event actions.
 - [General Tab](#)
 - [Router](#)
 - [Pause](#)
 - [Send](#)
- Items are automatically updated in Lucid Studio when they are published/unpublished in Voyager Template Links.
 - [Automatic Update](#)
- Automatic backup of outdated files.
 - [Automatic Backup](#)

Introduction

Congratulations on your selection of the Lucid Studio™ virtual control system. The Lucid Studio user experience represents the culmination of over 20 years of experience in real-time 3D virtual-set technology.

Lucid Studio is the latest incarnation of UX, with a new design and greater usability.

Lucid Studio brings ease-of-use to the historically complicated world of virtual-set and augmented-reality setup and operation by means of its intelligent architecture and its intuitive, touch-screen interface.

The Lucid Studio platform is highly flexible and customizable, delivering seamless integration of best-of-breed technologies, including tracking, chroma keying, robotics and real-time 3D rendering.

Lucid Studio 7.3 supports Voyager 7.3.
--

Lucid Studio 7.3 is compatible with XPression 11.5.5821.
--

The Lucid Studio platform consists of these main components:

[Lucid Track](#) - This is the application used to setup and operate the settings involved with camera tracking, in order to drive a virtual camera in an external renderer, with final camera position and rotation values. Lucid Track sends the camera values to the renderer using a defined network protocol.

[Lucid Studio](#) - The Lucid Studio user interface provides operational control with server and logic capabilities.

[Lucid Driver for XPression](#) - This application runs on the same machine as the renderer and allows Lucid Studio to remotely operate the project and select the camera to be tracked.

[RVS Engine Service](#) - This application runs on the same machine as the renderer machine and allows remote project start, stop and changes in both XPression and Voyager.

[Lucid MOS Service](#) - This application runs on the same machine as Lucid Studio and makes MOS published events visible in a News Room Control System.

These components run on one or more computers in a production system. There are two different functions that these computers serve:

- **User Interface System (Lucid Studio)** - the computer with the touch-screen console that is used to interact with Lucid Studio for setup, calibration, and operation.
- **Rendering System** - a computer with powerful graphics and SDI-interface hardware that is used to render the virtual graphics in real time.

Configurations can range from a single computer serving as both the user interface system and rendering system for a single-camera setup to a dedicated user interface system and multiple rendering systems, one for each of several cameras.

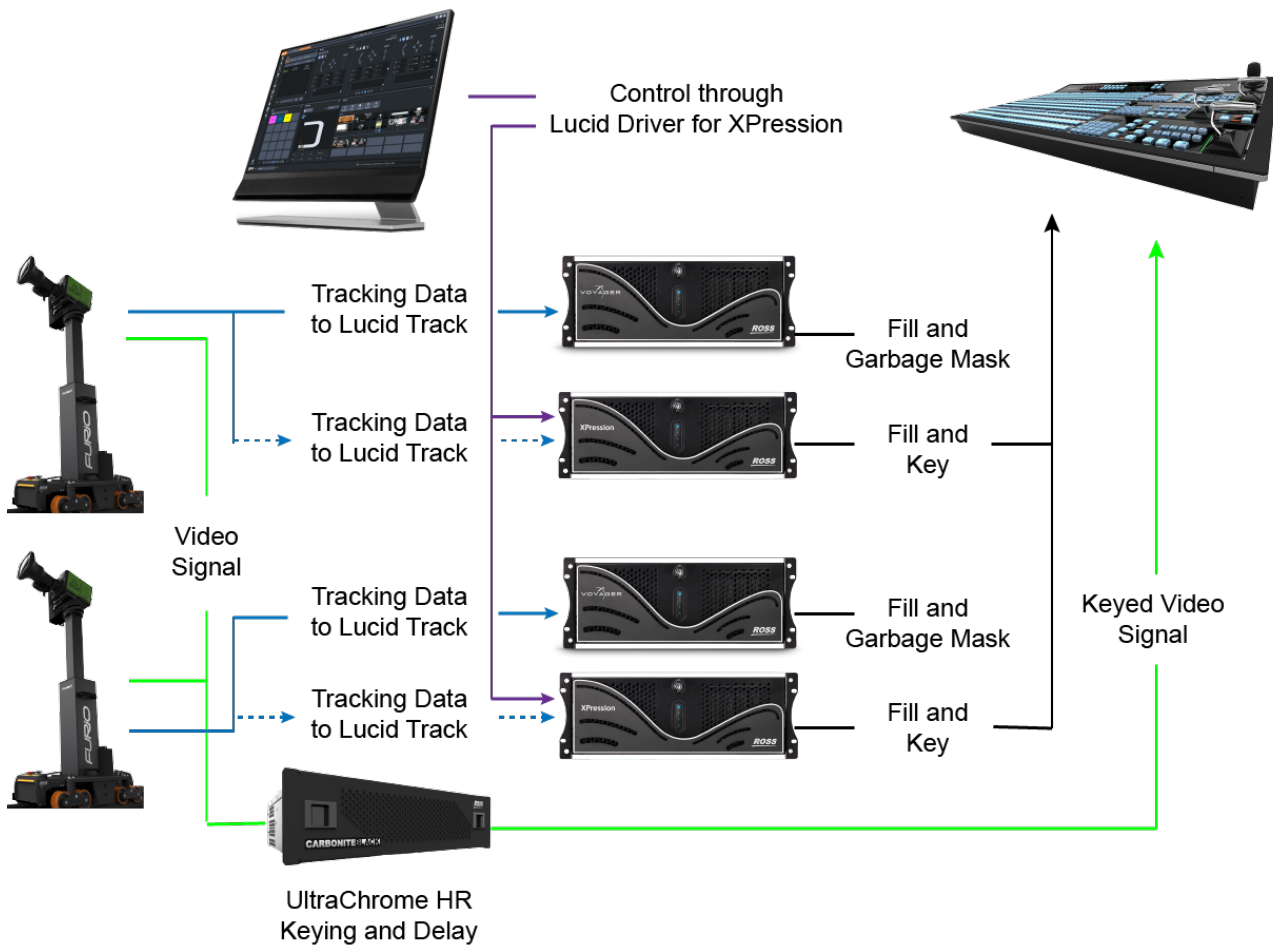

Typical Renderer Configuration

Welcome to the future of virtual sets and augmented reality. Welcome to Lucid Studio.

About This Guide

This guide covers the use of Lucid Studio. The following sections are included:

Introduction: summarizes the guide and provides important terms, conventions and feature descriptions.

Lucid Track: provides a description of the Lucid Track user interface and instructions on how to configure Lucid Track to send camera data to the renderer, using a defined network protocol.

Lucid Studio: provides a description of the user interface and instructions for setting up and operating a virtual studio.

Lucid Driver for XPression: provides a description of the Lucid Driver for XPression user interface and instructions for using the application.

RVS Engine Service: provides a description of the RVS Engine Service user interface and instructions for using the application.

Lucid MOS Service: provides a description of the Lucid MOS Service user interface and instructions for using the application.

Lucid Studio and DashBoard: provides instructions for setting up and using DashBoard to trigger Lucid Studio events and position changes.

Lucid Studio and Voyager: provides instructions for setting up Lucid Studio to run with the Voyager renderer.

XPression Gateway Setup: provides instructions for setting up the XPression Gateway to work with Lucid MOS Service.

If you have questions pertaining to the operation of Lucid Studio, please contact us at the numbers listed in the section [Contacting Technical Support](#). Our technical staff is always available for consultation, training, or service.

Documentation Conventions

Special text formats are used in this guide to identify parts of the user interface, text that a user must enter, or a sequence of menus and sub-menus that must be followed to reach a particular command.

Bold text Bold text identifies a user interface element such as a dialog box, menu item, or button.

For example:

In the **Slug** column, type a slug name for the story.

Italic text Italic text is used to identify the titles of referenced guides, manuals, or documents.

For example:

For more information, refer to the *DashBoard User Guide*.

Courier text Courier text identifies text that a user must type.

For example:

In the **Username** box, type `postgres`.

Menu Sequences Menu arrows are used in procedures to identify a sequence of menu items that you must follow.

For example:

If a step reads **Server > Save As**, you would select the **Server** menu and then select **Save As**.

[Hypertext](#) Identifies a hyperlink to a related topic.

Getting Help

Lucid Studio documentation is provided on the product USB key as a pdf and is also available by selecting the **Help** icon in the Lucid Studio UI.

Contacting Technical Support

At Ross Video, we take pride in the quality of our products, but if problems occur, help is as close as the nearest telephone.

Our 24-hour Hot Line service ensures you have access to technical expertise around the clock. After-sales service and technical support is provided directly by Ross Video personnel. During business hours (Eastern Time), technical support personnel are available by telephone. After hours and on weekends, a direct emergency technical support phone line is available. If the technical support person who is on call does not answer this line immediately, a voice message can be left and the call will be returned shortly. This team of highly trained staff is available to react to any problem and to do whatever is necessary to ensure customer satisfaction.

- Technical Support:
 - 1-844-652-0645 (North America)
 - +800 1005 0100 (International)
- After Hours Emergency: (+1) 613-349-0006
- E-mail: techsupport@rossvideo.com
- Website: <http://www.rossvideo.com>

Installation Notes

Please read the following installation notes before installing Lucid Studio 7.3.

License Version

There are 3 Lucid Track license versions: a full license, **Position and Rotation Only**, and **Position Only**.

If Lucid Track attempts to run with a license that is not in the dongle, a pop-up message appears displaying the available licenses.

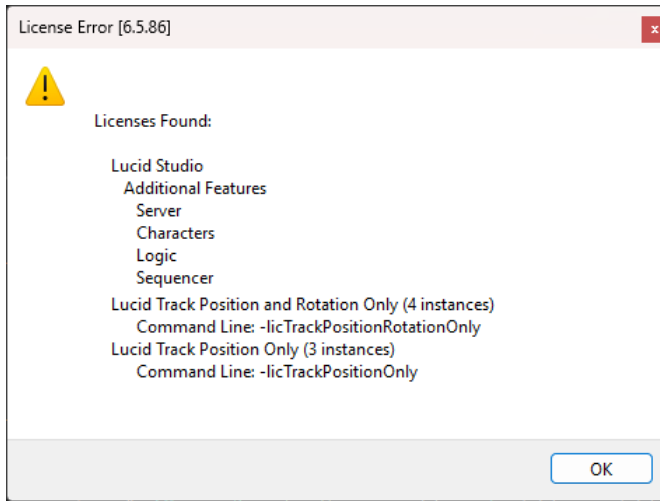

Available Licenses

If you require a different or additional license, contact techsupport@rossvideo.com.

Assigning Licenses

If you want to use a **Position and Rotation Only**, or **Position Only** license, you must assign a specific license to each instance of Lucid Track, using the **Command Prompt** window or by creating a permanent shortcut.

To assign a license using a command line:

- In the **Command Prompt** window, enter one of the following commands:

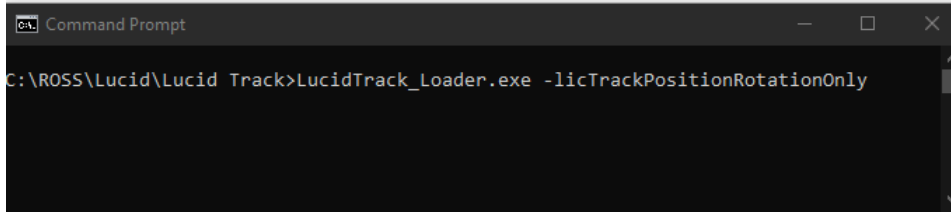

```
C:\ROSS\Lucid\Lucid Track>LucidTrack_Loader.exe -licTrackPositionRotationOnly
```

Position and Rotation Only License

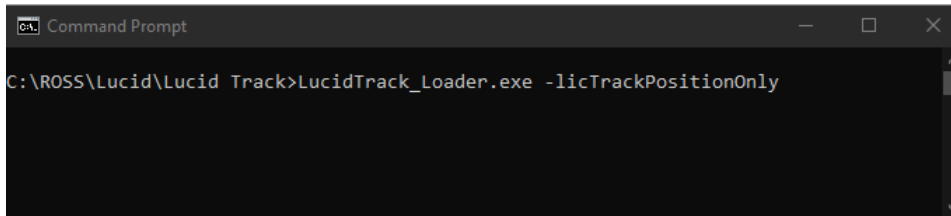

```
C:\ROSS\Lucid\Lucid Track>LucidTrack_Loader.exe -licTrackPositionOnly
```

Position Only License

To assign a license using a permanent shortcut:

1. Right-click the Lucid Track icon for the Lucid Track instance to which you want to assign a license and from the menu, select **Properties**.

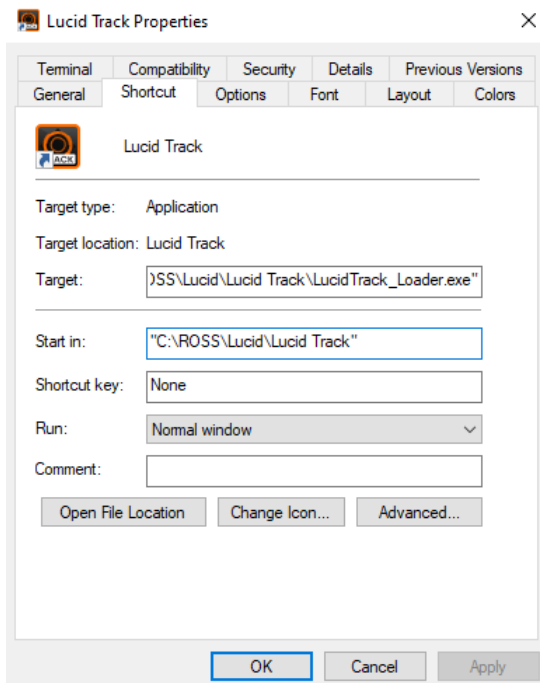

Lucid Track Properties

2. In the **Shortcut** tab, in the **Target** field, following the ending quotation marks, enter the command line argument for the license you want to assign to that instance of Lucid Track.

E.g., `-licTrackPositionOnly` (leaving a space before the hyphen) to assign a **Position Only** license, or `-licTrackPositionRotationOnly` (leaving a space before the hyphen) to assign a **Position and Rotation Only** license.

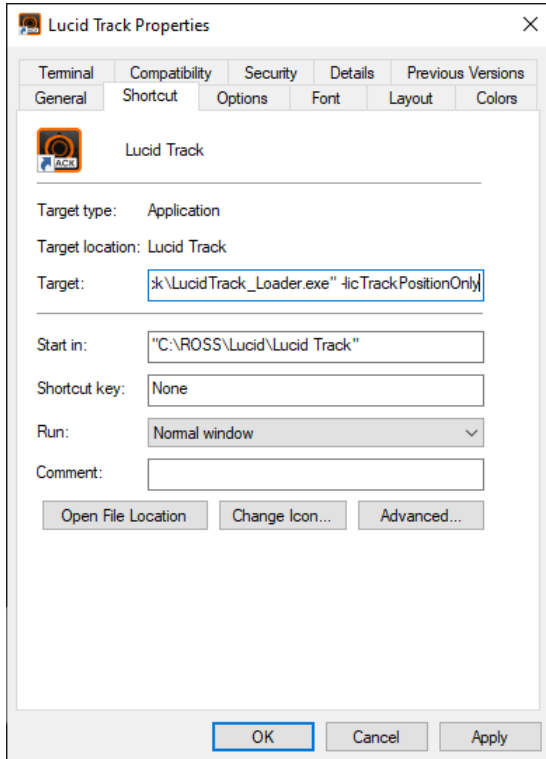

Lucid Track Properties - Assign License

3. Then select **Apply** and **OK**.

The license is applied to the selected Lucid Track instance and when that instance is launched, it will display the properties specific to that license.

Python Version

Lucid Studio 7.3 requires Python version 3.12.11. This version is included in the installation software and automatically installed, but you'll need to remove any previous version of Python that exists on your Lucid machine(s).

XPression License Tool

As of Lucid Studio version 6.4 there is an option in the **Select Components** window to install the XPression License Tool. This tool allows you to check and if necessary, update your Lucid Studio license. It is unchecked by default, so if you want to use it, you'll need to select it.

To use the XPression License tool:

1. During installation, in the **Select Components** window, select the **XPression License Tool** checkbox.

The **XPression License Tool** is installed in the following location: **C:\ROSS\Lucid**.

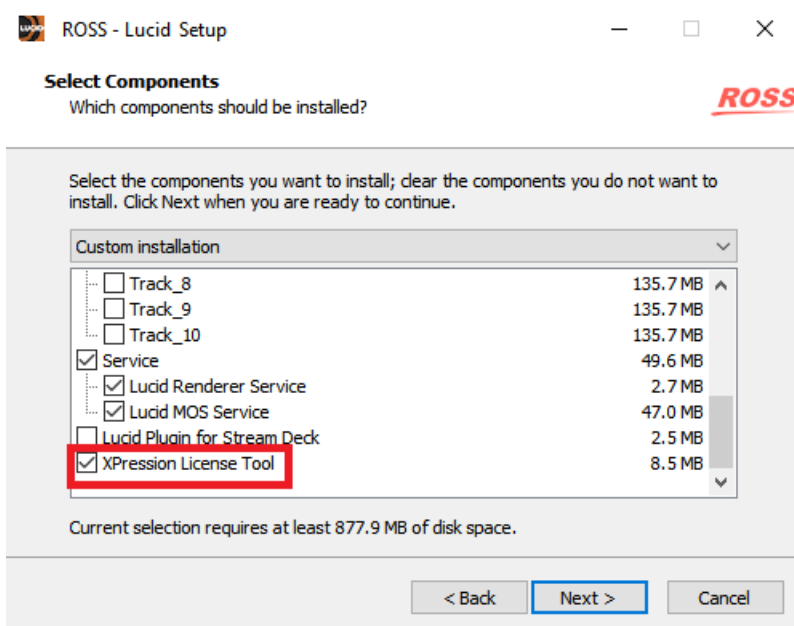

XPression License Tool

2. After installation is complete, go to **C:\ROSS\Lucid\XPression License Tool** and run the **xpLicenseTool.exe** file.

The tool opens with the **Machine Information** window.

XPression Licensing Tool - Enter Machine Information

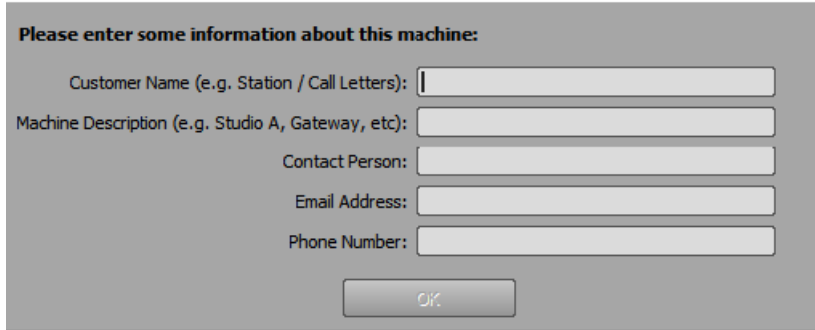

The screenshot shows a dialog box titled "XPression Licensing Tool - Enter Machine Information". The dialog box has a grey background and a white border. At the top, it says "Please enter some information about this machine:". Below this, there are five text input fields, each with a label to its left: "Customer Name (e.g. Station / Call Letters):", "Machine Description (e.g. Studio A, Gateway, etc):", "Contact Person:", "Email Address:", and "Phone Number:". Each field is currently empty. At the bottom center of the dialog box, there is an "OK" button.

XPression Licensing Tool - Machine Information

3. Enter your machine information and select **OK**.

The license tool will read your license dongle and display a list of all products covered by your license along with their **Purchase Date**, **Software Maintenance Expiry** and **Eligible SW Version**.

4. To update your Lucid Studio license, select the **Connect and Update Licenses button**.

The tool will download the available licenses.

5. In the **Confirmation** dialog, select **Yes** to update your licenses.

A message appears indicating the successful update of the licenses.

6. Close the **XPression License Tool**.

Advanced User Options

There are a number of command line arguments available for Lucid Studio and Lucid Track to allow quick modifications.

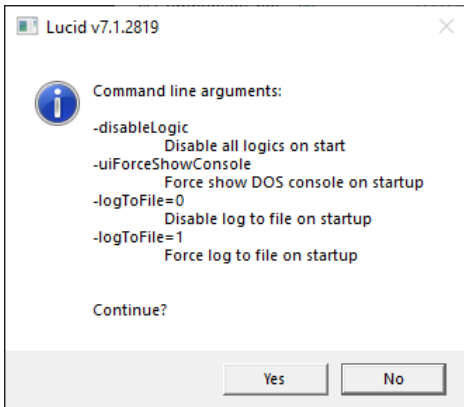

Command Line Arguments - Lucid Studio

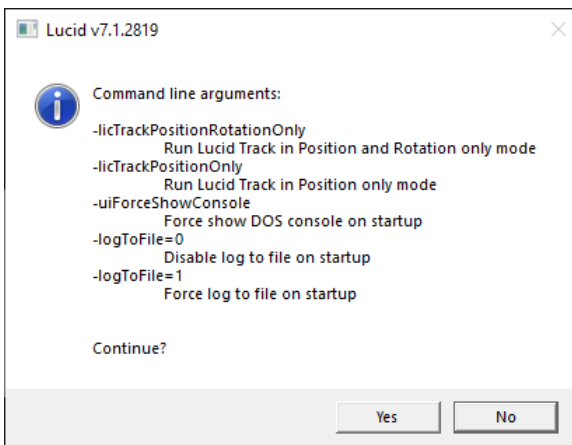

Command Line Arguments - Lucid Track

You can access the list of command line arguments by entering the following command in the **Command Prompt** window:

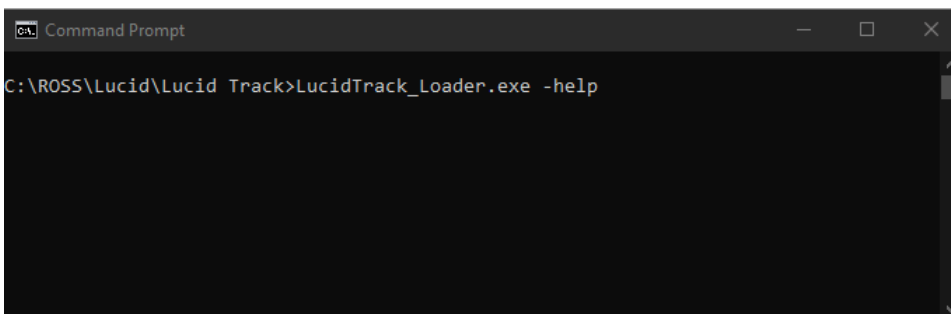

Lucid Track

Lucid Track is used in augmented reality and virtual set applications in conjunction with cameras that provide tracking information to align the virtual world with the real world. For example, the virtual floor is exactly where the real floor of your studio is. Talent moving in the video frame will appear to be standing on a virtual floor.

To keep the visual effect of a real world object moving in a virtual world, the virtual world needs to match its camera to the real world's camera position in 3D space.

There are position tracking encoders inside the robots, cameras, and lenses that tell the virtual world where the real world is. This is referred to as raw tracking data.

Lucid Track takes in raw encoder tracking data, and outputs render ready data in Lucid Studio protocol. Render ready data is raw data to which offsets that have been set by the user in Lucid Track have been applied.

This chapter describes Lucid Track in its stand alone state with one camera tracking source. This configuration allows one camera source to send data to one or more renderers (same data to all renderers). Lucid Track can also be controlled remotely through the Lucid Studio interface. See [Driven Remotely Mode](#).

[Launching Lucid Track on Custom Hardware](#)

[Exploring the Lucid Track User Interface](#)

Launching Lucid Track on Custom Hardware

The first time you launch Lucid Track, the **Windows Security Alert** message appears and **Windows Defender Firewall** will block the application. This message does not appear on hardware provided by Ross Video.

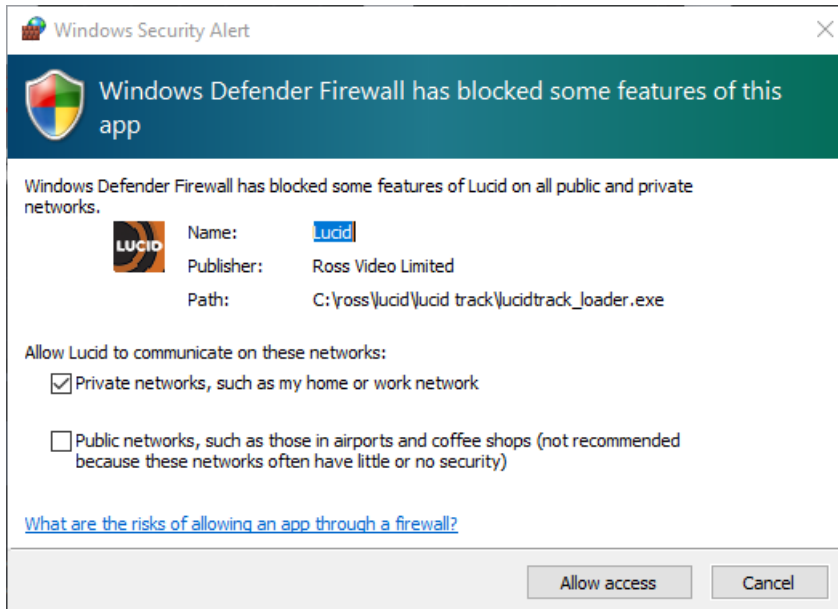

Windows Security Alert

To unblock Lucid Track:

1. In the **Allow Lucid to communicate on these networks:** section, select **Private networks**.
2. Then select **Allow access**.

You won't see this message again.

Exploring the Lucid Track User Interface

This section provides an overview of the Lucid Track user interface, with links to more information and instructions.

The Lucid Track fully licensed interface at startup can be seen in the figure below.

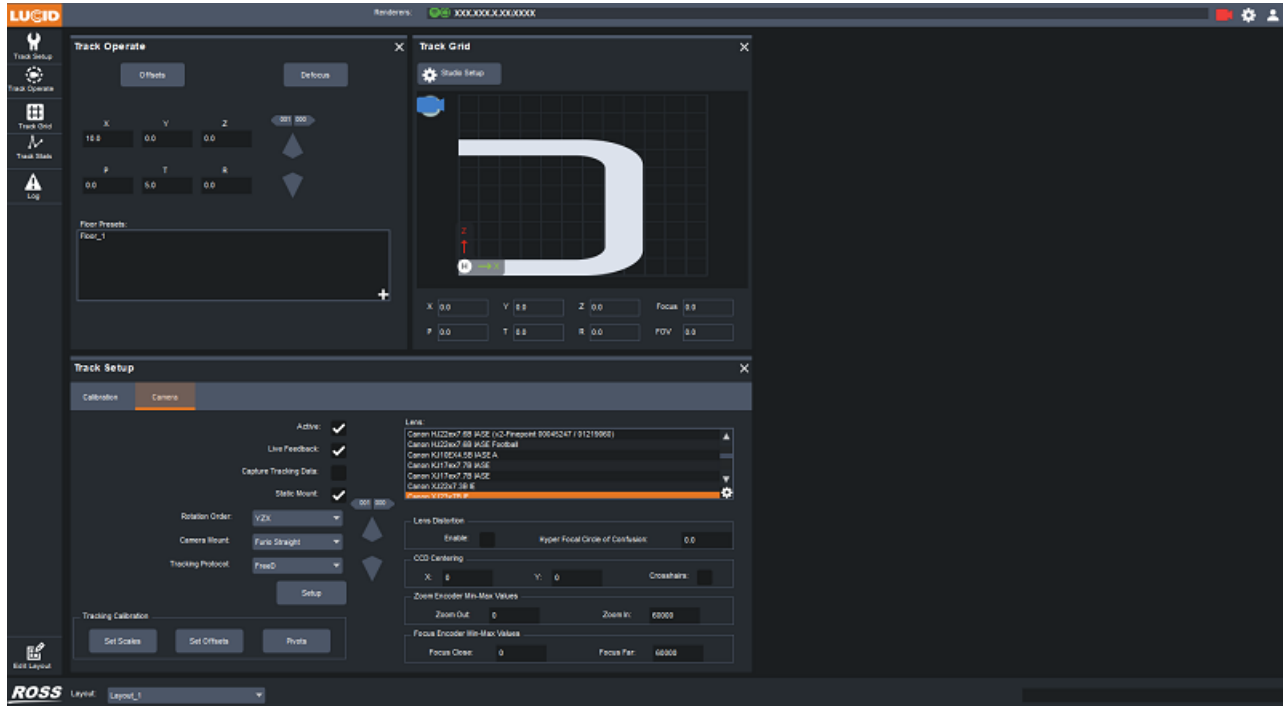

Lucid Track User Interface

Settings

When launching Lucid Track for the first time, you'll need to configure the Lucid Track settings. The settings are accessed by selecting the gear icon in the upper-right corner of the user interface.

For information about setting up Lucid Track, see [Setup](#).

Renderers

At the top of the screen, the connected renderers are displayed by IP address and port number.

For information about adding renderers, see [Track](#).

Panels

The Lucid Track user interface has a dynamic layout that can be customized to include any or all of the panels listed in the left-hand column.

For information about each panel, see [Panels](#).

Layout

In the bottom-left corner of the user interface is the Edit Layout button. This feature allows you to add the panels you need to the layout, make some panels larger and rearrange them as desired.

The Layout drop-down provides options for saving and discarding changes to the layout, changing the layout name, and saving the layout with a new name.

For information about managing layouts, see [Customizing and Managing Layouts](#).

Log

In the bottom-right corner of the UI, the last line of the log is displayed. To view more of the log entries, double-click this line. This opens up a replication of the Log panel.

For information about the Log panel, see [Log](#).

Setup

The **Setup** tool is accessed by the small gear icon, located in the upper-right corner of the UI. This tool allows you to add renderers, save or backup your track configuration file, manage users, and set network-related and other configuration information.



Lucid Track - Settings Tool Location

The **Setup** tool contains several tabs, as shown below:

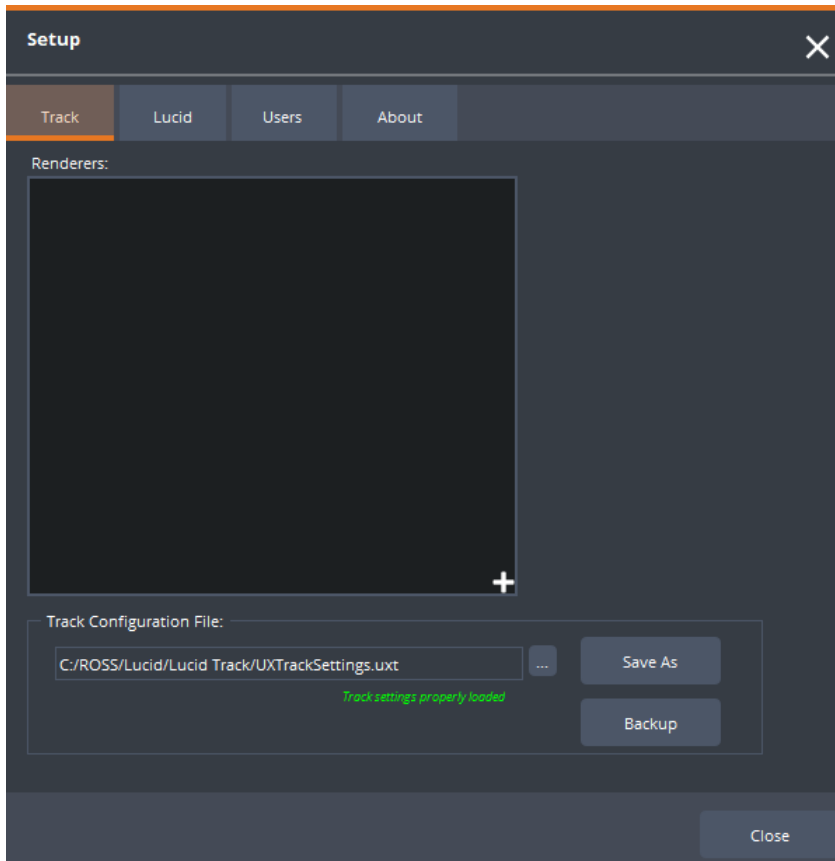

Lucid Track - Setup Tool

The **Setup** options are described in the following sections:

[Track](#)

[Lucid](#)

[Users](#)

[About](#)

Track

In the **Track** tab, you can add renderers and save or back up your track configuration file.

The Track configuration file contains information about the way you've configured the tracking-related settings in Lucid Track. The main reason for storing tracking settings is to accommodate multiple sets within the same studio. The file is saved with a **.uxt** extension.

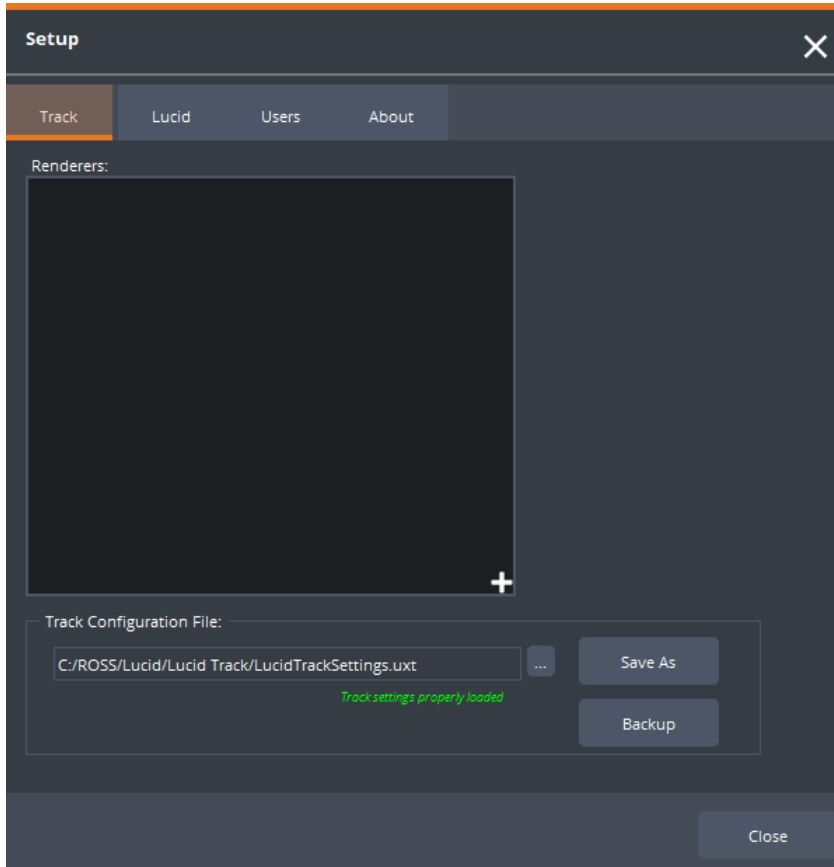

Lucid Track Setup - Track Tab

To add a renderer

1. Select the + icon in the lower-right corner of the Renderers pane.

The **Add Renderer** window opens.

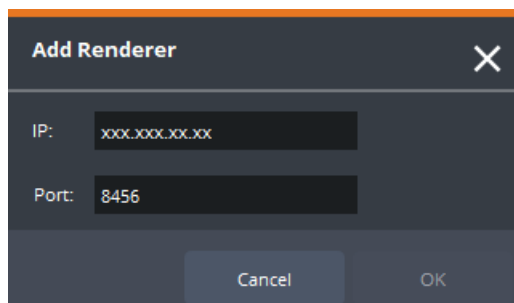

Add Renderer

2. In the **IP** field, enter the IP address of the machine running your renderer.

The **Port** field is automatically filled with the default port (**8456**).

3. Select **OK** to add the renderer or **CANCEL** to close this window without adding a renderer.

When a renderer has been added, you will see two icons to the left of the renderer, as follows:

- **Network status:** A green icon indicates that the renderer machine is available on the network. A red icon indicates that it is not.
- **Renderer status:** A green icon indicates that the renderer is connected. A red icon indicates that it is not.

Tip: When you hover your mouse over the icons, a tool tip provides the status.

Any changes made are automatically saved to the currently selected **Track Configuration** file.

To save a track configuration file with a different name:

1. Select the **Browse** button beside the **Track** configuration file field to navigate to the folder in which the track configuration file is stored.
2. Select **Save As** to give the track configuration file a recognizable name and save it to the default location, **C:\ROSS\Lucid\Lucid Track**.

Any configuration changes made are automatically saved to the current file.

To save a backup file:

- Select **Backup** to save a copy of the track configuration file that is dated and time-stamped.

The backup file has the extension **.uxt.backup**.

If you later need to restore your settings by loading the backup file, a copy of the file (with the **LucidTrackSettings.uxt** extension) is loaded and the original backup remains.

Lucid

In the **Lucid** tab you can configure the network settings, units selection, UI scale factor, remote operation and notifications, as described below:

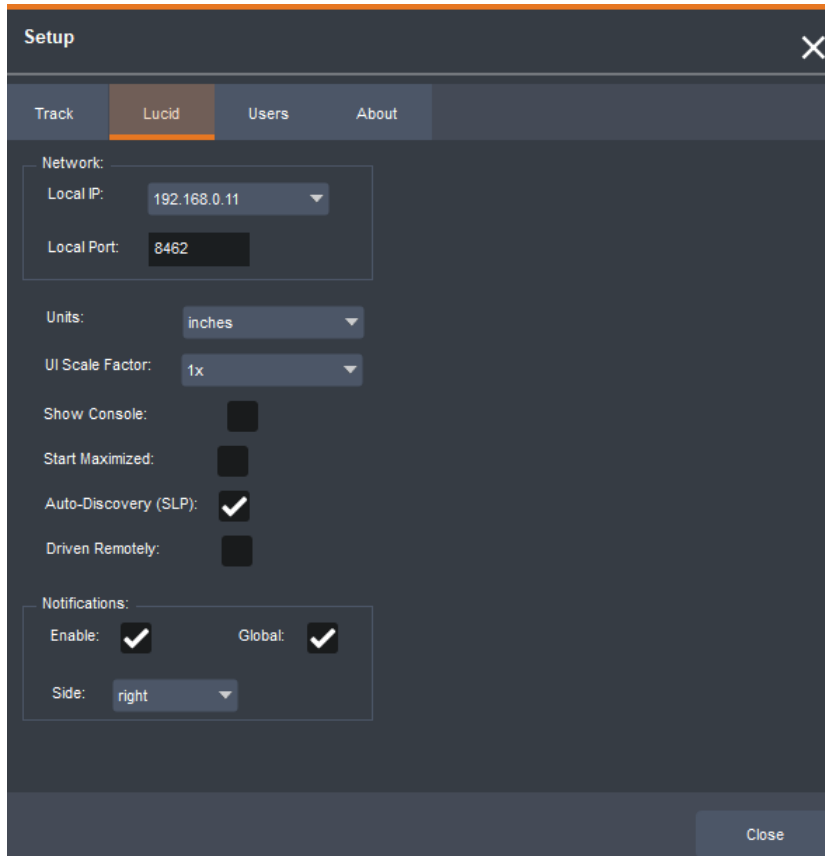

Lucid Track Setup - Lucid Tab

• Network Settings

- **Local IP** displays a list of the available IP addresses in the system. All Lucid Tracks, Lucid Studio, renderers and cameras need to be on the same subnet.

An IP address is a numerical identifier that is recognized by networked devices such as servers and computers, and this is how websites and other internet locations are uniquely identified.

- **Local Port** is where you can change the listening port number, if the default port is in use.

The default port is 8461.

The IP address and listening port must be identified, given that you can have multiple networks. For example, a world wide network and an internal user network.

These fields are automatically populated with default values, which include local IP addresses available in the system running Lucid Studio.

★ You cannot operate multiple applications on the same port at the same IP address. Typically, Lucid Studio and Lucid Track are not on the same machine.

• Units Selection

The Units drop-down allows you to specify the units that will be used for measuring positional offsets and other linear measurements, either inches or centimeters.

- **UI Scale Factor**

When using a larger monitor, select 1.25x from this drop-down to increase the size of the UI. If you change the UI Scale Factor, you will need to restart Lucid Track for the setting to take effect.

- **Show Console**

Select the Show Console checkbox to keep the log window open or clear the checkbox to close the window. The window can be minimized.

- **Auto-Discovery (SLP)**

Select the Auto-Discovery checkbox to allow Lucid Studio to automatically detect any Lucid Track.

Default is selected.

- **Driven Remotely Mode**

After setting up a tracking source and renderer for Lucid Track, it can be set to **Driven Remotely** mode, which allows Lucid Studio to have control over its settings and receive its tracking data.

When the **Driven Remotely** checkbox is selected, the Lucid Track application is set to read-only.

To exit from Driven Remotely mode:

1. In the **Users** panel, from the **Users** list, select **Admin**.
2. Select **Log In**.
3. Enter the **Admin Password** and select **OK**.

The default password is "ross".

- **Notifications**

When enabled, important notifications such as successful (or unsuccessful connections) will be displayed.

➤ If the **Global** checkbox is selected, the notifications appear on the Windows desktop.

➤ If the **Global** checkbox is not selected, the notifications will appear on the Lucid Studio UI.

From the **Side** drop-down, select whether notifications should appear on the left or right side of the screen.

Users

In the **Users** tab, you can add and delete users, set/reset their user privilege and password and set a user to be the default user at startup. By default, the user profile is set to Admin. You can also upload a photo of the user.

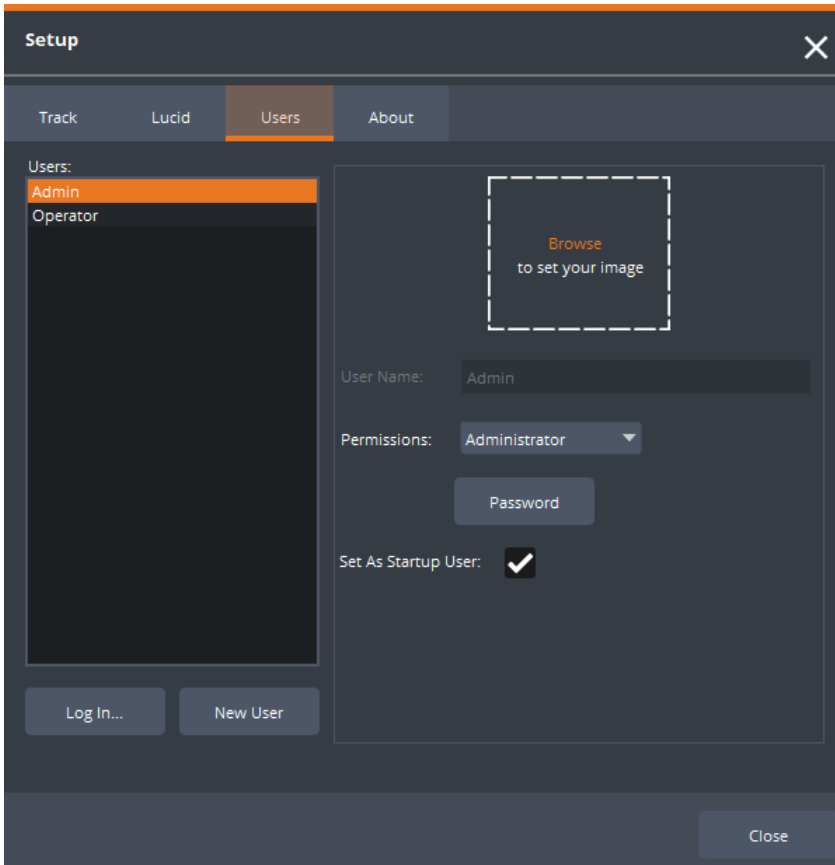

Lucid Track Setup - Users Tab

To add a user:

1. Select the **New User** button.

The **New User** window opens.

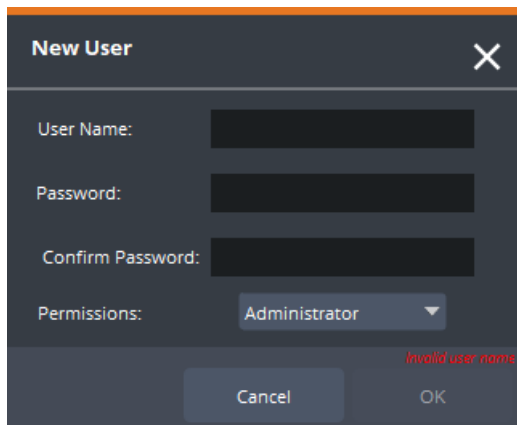

New User

2. In the **User Name** field, enter a name for the new user.

3. In the **Password** field, enter a password for that user.
4. In the **Confirm Password** field, re-enter the password.
5. From the **Permissions** drop-down, select the permission level you want to assign to the new user.
6. Then select **OK**.
7. Left-click inside the **Browse** to set your image frame, navigate to a photo of the user and select **Open** to add the photo (optional).
Right-click to delete a photo.

To delete a user:

1. From the **Users** list, right-click the user you want to delete and select **Delete**.

The **Delete User** confirmation dialog opens.

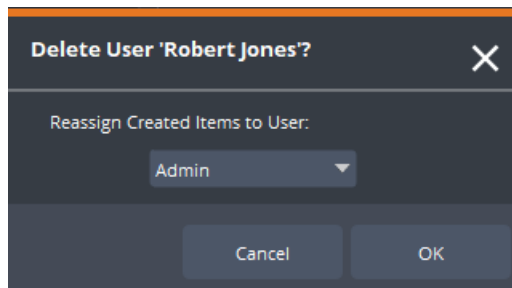

Delete User

2. From the drop-down, select the user to whom you want to reassign created items.
Reassigning created items gives control of anything that was created by the deleted user to the user you select, either the **Administrator** or the **Operator**.
3. Select **OK** to reassign created items and delete the user.

To change the user password:

1. Select your user name and select **Log In**.
2. Select the **Password** button.
The **Change Password** window opens.
3. Enter the current password in the **Old Password** field.
4. Then enter the new password in the **New Password** and **Confirm Password** fields.
5. Select **OK**.

Any user can change their own password. The default passwords are:

- **Admin:** ross
- **Operator:** operator
- **Other:** the name of the user, eg. user1's password would be "user1", Bob's password would be "Bob"

As a standard security measure, change the default passwords when you begin using Lucid Studio.

To change permissions:

1. Select the user whose permissions you want to change.
2. From the **Permissions** drop-down, select one of the following permission levels to assign to that user.
 - **Administrator**: gives unrestricted access to adding, deleting and changing components in all panels, deleting or renaming users and changing their own password.
 - **Operator**: restricts the user to operations-oriented functions and changing their own password.
 - **Read-Only**: allows the user to read the UI but not make changes and change their own password.

To designate a user as the default user at startup:

1. Select the user you want to designate as the default user at startup.
2. Select the **Set As Startup User** checkbox.

In this way an administrator can make changes to Lucid Track, close the application and the next time Lucid Studio is launched, the designated user will be automatically activated.

About

The **About** tab provides confirmation that the Lucid Track license is valid. It allows users to see what version of Lucid Track is installed and includes third party licenses. Normally, Lucid Track is licensed with a USB dongle.

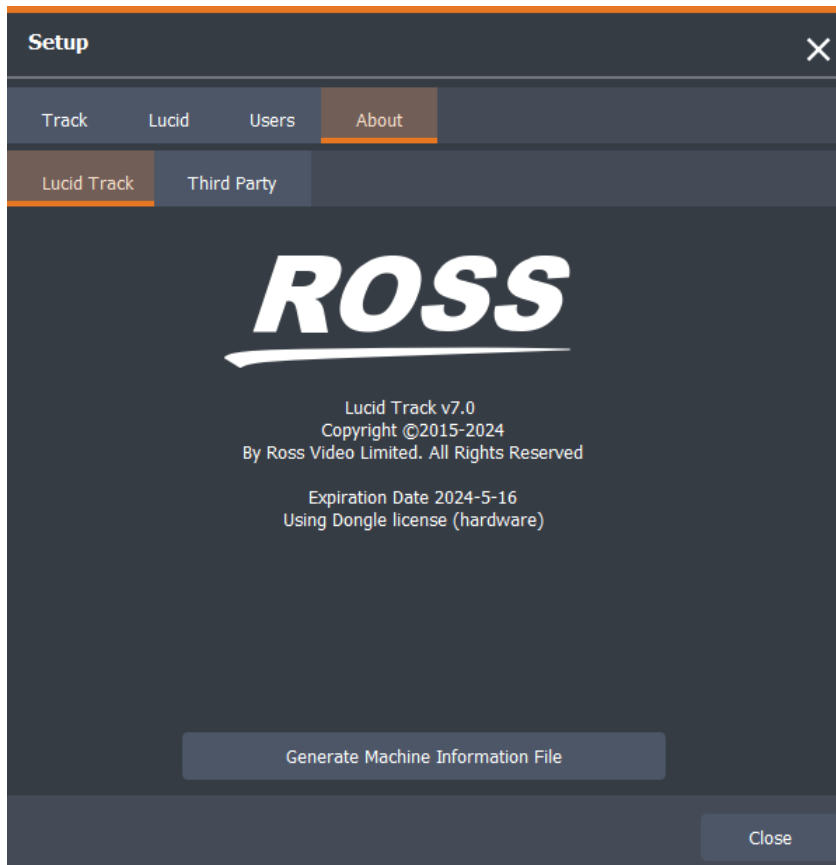

Lucid Track Setup - About Tab

If your license is invalid, you can get a new one. This should only be necessary when a new system (computer, network card, disk drive) is being licensed (or relicensed) and you don't have a license dongle.

To get a new license, see:

[Contacting Technical Support](#)

Panels

The Lucid Track user interface has a dynamic layout that can be customized to include any or all of the panels listed in the left-hand column.

In the column on the left side of the screen, the available panels are listed. Descriptions of each panel can be found in the following sections:

[Track Setup](#)

[Track Operate](#)

[Track Grid](#)

[Track Stats](#)

[Log](#)

Track Setup

The **Track Setup** panel is used to configure the camera calibration, the camera parameters and the tracking calibration.

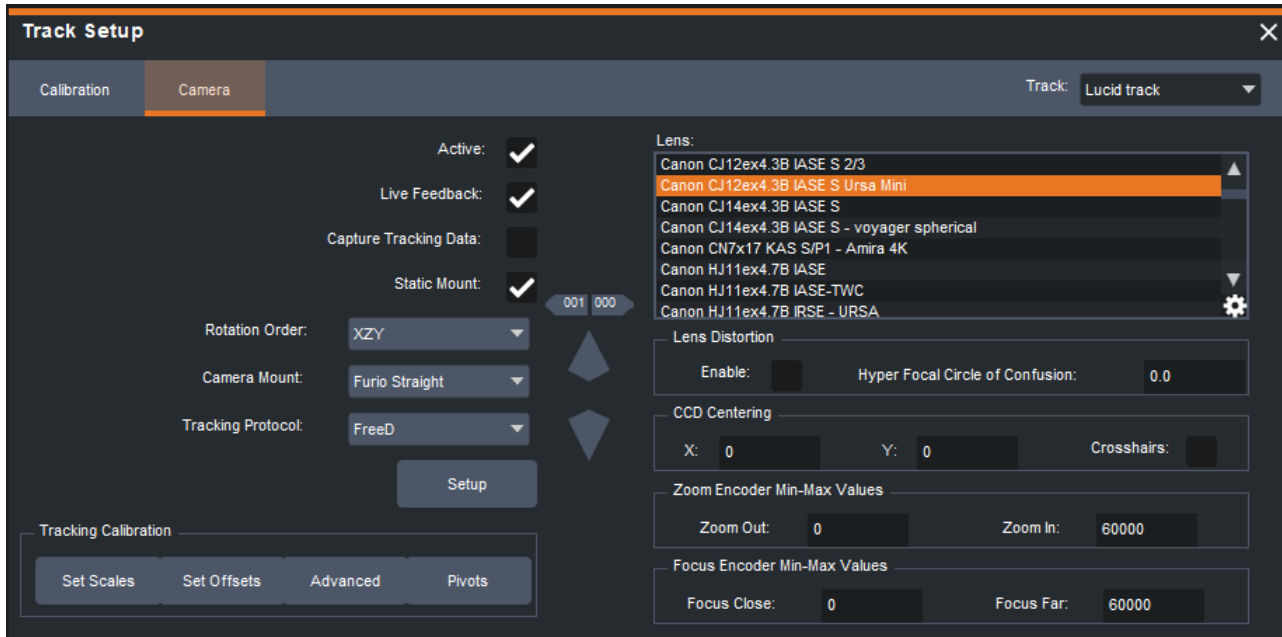

Track Setup Panel

The Track drop-down on the right allows you to select the Lucid Track you want to control. Any camera-specific configuration parameters or commands will be applied to the selected Lucid Track.

★ Lucid Track represents the real camera and the Renderer represents the virtual camera.

Tip: For any numeric editor in Lucid Studio, the mouse wheel will modify the digit where the mouse cursor is. For example, in the number 123.45, if the cursor is between 1 and 2, the number will change to 133.45, 143.45, etc as you scroll the mouse wheel up; or 113.45, 103.45 as you scroll the mouse wheel goes down.

This section covers the following topics:

[Calibration](#)

[Camera](#)

Calibration

The content of the **Calibration** tab varies depending on the camera mount selected in the **Camera** tab. At a minimum, it contains the three offset values of the camera relative to the three axes of rotation. In each case, the offset is the distance from the center of the camera's lens (at the point where the lens meets the camera body) to the rotational axis.

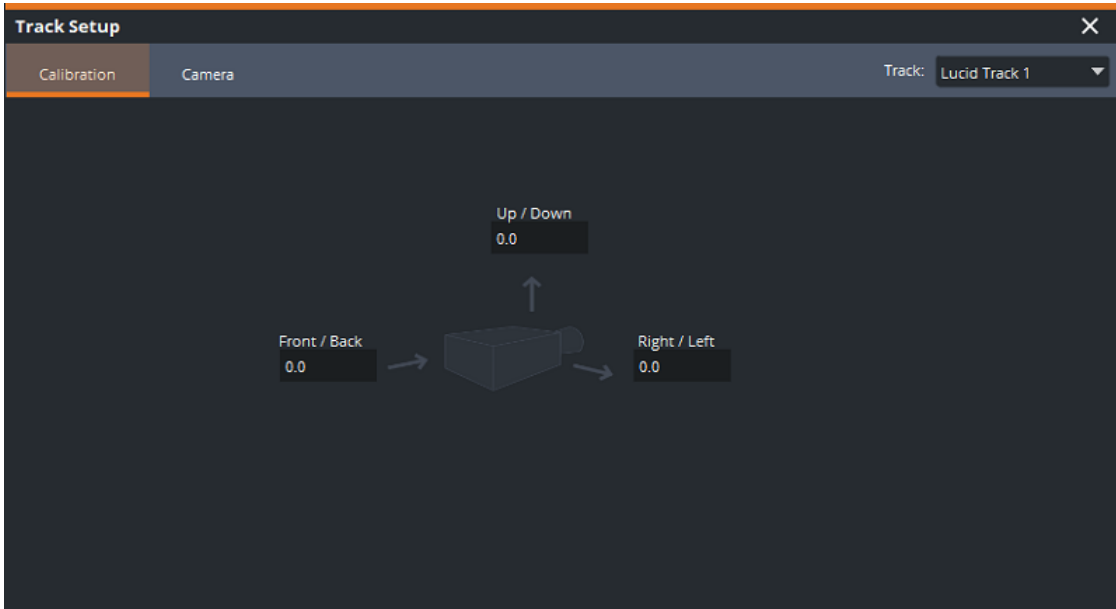

Calibration

The **Up/Down** offset is the vertical distance from the center of the lens to the horizontal axis on which the camera tilts.

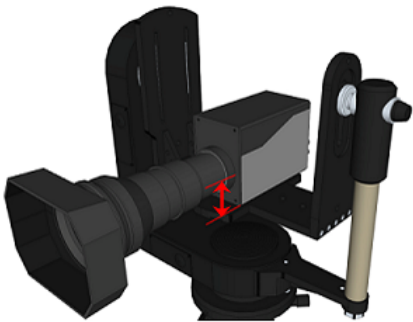

Up/Down Offset

The **Right/Left** offset is the horizontal distance from the center of the lens to the vertical axis around which the camera pans.



Right/Left Offset

The **Front/Back** offset is the horizontal distance forward or back from the point at which the pan and tilt axes intersect.



Front/Back Offset

In addition to these three basic offsets, there may be additional offsets required depending on the mount type (see description below). If, for example, the mount type is a jib, you will need to enter:

- the height of the main pivot
- the jib arm length
- the nose pivot up-down offset (relative to the arm)
- the nose length
- the tilt from pan-axis offset

The screen shows a graphic depiction of a the selected camera to indicate where these measurements are taken.

Camera

The **Camera** tab captures information about the camera's setup. The left side contains tracking parameters and the right side contains lens information.

After being updated by the scales, offsets and other calibration modifiers, the render-ready data is sent to a renderer which manipulates existing cameras in the virtual set.

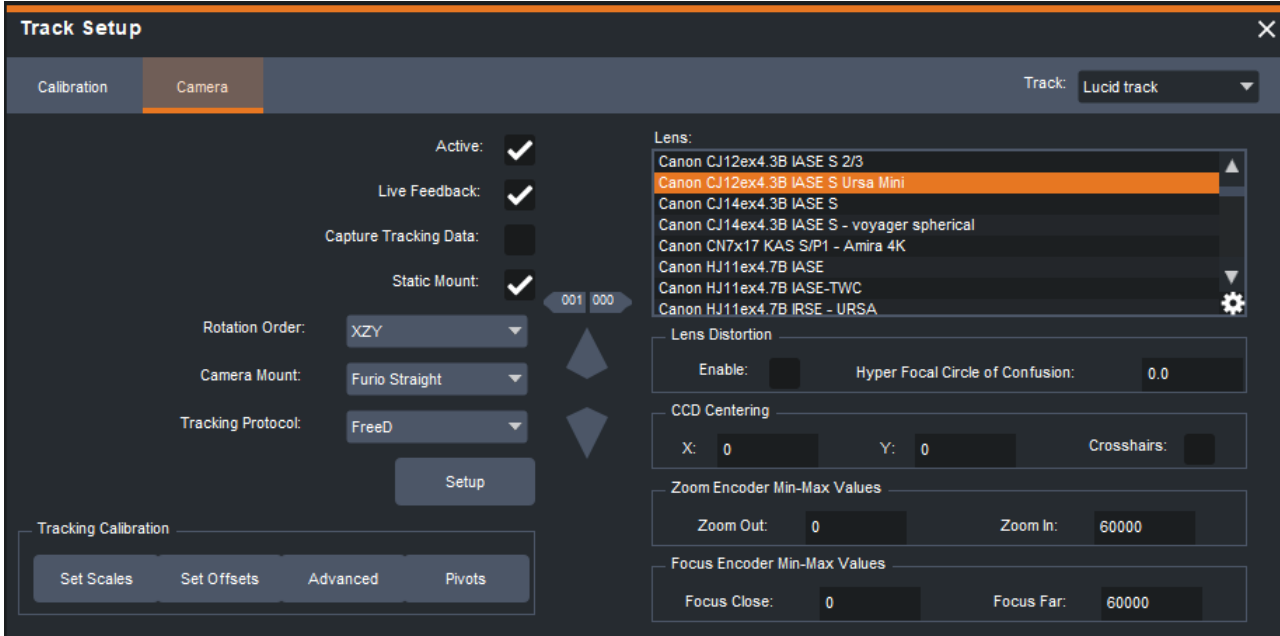

Camera

The **Camera** tab contains the following parameters:

[Tracking Parameters](#)

[Tracking Calibration](#)

[Lens Information](#)

TRACKING PARAMETERS

- **Active**

If this box is selected (default), the tracking for the selected camera is enabled. Clearing this box will cause the driver for the selected camera to stop accepting tracking data from the camera.

- **Live Feedback**

If this box is selected (default), the tracking data received by the driver for the selected camera will be continually sent to the UI for the operator to see. If this box is unchecked, the driver will continue receiving and processing tracking data, but will not send updates to the UI.

- **Capture Tracking Data**

Saves data to a file in the Track Log folder. By default, the file will be saved in **C:\ROSS\Lucid\ Lucid Track**.

To change the location of the track-logging folder:

1. Select the **Setup** button under the **Tracking Protocol** field.
2. Select the **Browse** button beside the **Track Log Folder** field.
3. Navigate to the location where you want to store the Track logs and select **Open**.

- **Static Mount**

When selected, this checkbox indicates that the camera is stationary. When cleared, it indicates that the camera is mounted on a moving tracking system and allows for positional data to be transmitted.

- **Rotation Order**

Selects the order of axis of rotation used for adjusting camera position. For example, **XZY** will apply the rotation in the X axis first, then the Z axis, then the Y axis. The default setting is **XZY**.

- **Camera Mount**

Selects what type of head and mount the selected camera is using. This is very important, as it may enable or disable certain axes, change tracking data scale values, etc.

- **Tracking protocol**

Specifies which protocol is being used for tracking telemetry data. Different heads or mounts may use different protocols, and some heads (e.g., Furio) can use more than one protocol. The tracking protocol that matches the selected camera mount is displayed by default. Make sure the protocol selected here matches what is being produced by the selected head and mount. More protocols can be added if required.

- **Setup**

Located under the **Tracking Protocol** drop-down, the **Setup** button opens a window that displays the values Lucid Track will send to the tracking parser in the renderers and configuration for the **Track Anomaly Filtering** on the left side. Not every parameter is supported by every protocol. The right side contains setup parameters specific to the selected protocol.

The **Tracking Data UDP Port** is the listening port for the selected protocol. This port must match the **Tracking** port of the renderer.

Some protocols will have more specific traffic handling parameters.

A few protocols (Trackmen, Stype and NCam) provide lens distortion data. In this case, you can select which lens distortion data you want to use, either the protocol specific data or the **Lucid Curves** data, from the **Lens Distortion** drop-down.

When using protocol-specific lens distortion, ensure that the **Lens Distortion** checkbox is selected in the **Values to Send to Renderers** section.

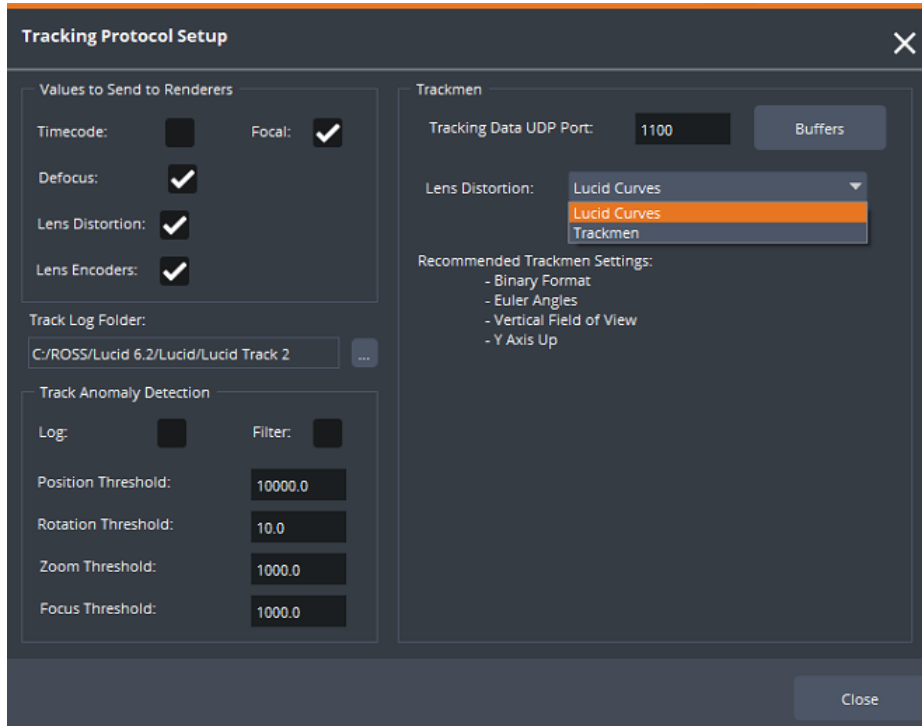

Tracking Protocol Setup - Trackmen

The **Buffers** parameter is common to all protocols. When you select **Buffers**, a window opens with positional data fields that allow you to manually adjust for delays. If you need to use this adjustment, match the delays to the slowest encoder.

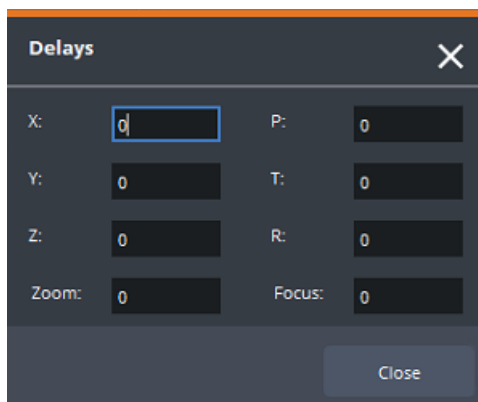

Buffers

TRACKING CALIBRATION

The [Set Scales](#) and [Set Offsets](#) buttons in this section set the global scales and offsets respectively. These global values are established as part of the calibration process.

The [Advanced](#) button opens a window where you can select the order in which the camera rotations should be applied for the final values calculation.

The [Pivots](#) button opens a read-only window with the **Pivots Values** displayed.

These global values establish the relationship between the real world of the physical studio and the 3D volume within which each of your cameras are being tracked. This is necessary, for example, to align disparate tracking technologies that may have different tracking-system-dictated origins. It could also be necessary to align multiple tracked cameras using the same tracking technology, but which are bound to different locations (e.g., a curved-track Furio system and a straight-track Furio system).

Set Scales

This button opens a pop-up window in which you can enter scale values for a number of calculated values. This is where, for example, the scale value is applied to translate from a Furio track system's encoder values to real-world units (e.g., inches or centimeters). You can also reverse direction of a given parameter. For example, to make tilt reverse its direction, enter a negative value in the **Tilt Scale** field. The fields in the pop-up are as follows:

- **Dolly**

Movement along a dolly track, if one is in use.

- **Swing**

For jib mounts, this refers to the jib-arm swing (Y-axis rotation).

- **Elevate**

For jib mounts, this refers to the jib-arm elevation (X-Axis rotation).

- **Extend**

If a telescopic jib is in use, this refers to the extension of the telescopic jib arm.

- **Pan**

This is the standard **Y** rotation movement.

- **Tilt**

This is the standard **X** rotation movement.

- **Roll**

This is the standard **Z** rotation movement.

- **X, Y, and Z Positions**

These are the standard location **X**, **Y** and **Z** coordinates in 3D space.

- **Zoom**

This refers to changes in lens zoom.

- **Focus**

This refers to changes in lens focus.

- **Value Change Control**

The **Value Change Control** determines the increment by which change is applied for each click of the **Up/Down** arrows.

To use it, select the input field whose value you want to change, select the desired scale value (i.e., how much change should occur for each click of an arrow button - ranging from **0.001** to **100**), and then select the up or down arrow to make the change.

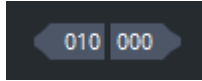

Value Change Control

- **Up/Down Arrows**

These arrows increase or decrease the selected value by the increment chosen in the **Value Change Control**.

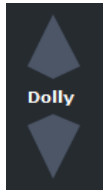

Up/Down Arrows - Tracking Scales

Set Offsets

This button opens a window in which you can enter offset values for the tracked 3D space relative to the global, or real world 3D space. This is particularly useful if you're using a track system that is not aligned along an axis in the physical space. If, for example, you had a Furio track that was at a 15-degree angle relative to the physical space, you could apply a 15-degree offset to the **Y Rotation** so that the track, in tracked space, is properly aligned along the X-axis. The fields in the pop-up are as follows:

- **X Position, Y Position, Z Position**

These are the standard location coordinates in 3D space.

- **X Rotation, Y Rotation, Z Rotation**

These are the standard rotation movements (**Tilt**, **Pan**, and **Roll** respectively).

- **Value Change Control**

The **Value Change Control** determines the increment by which change is applied for each click of the **Up/Down** arrows.

To use it, select the input field whose value you want to change, select the desired scale value (i.e., how much change should occur for each click of an arrow button - ranging from **0.001** to **100**), and then select the up or down arrows to make the change.

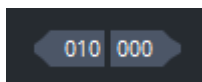

Value Change Control

- **Up/Down Arrows**

These arrows increase or decrease the selected value by the increment chosen in the **Value Change Control**.



Up/Down Arrows - Tracking Offsets

Advanced

This button opens the **Advanced Tracking Calibration Settings** window.

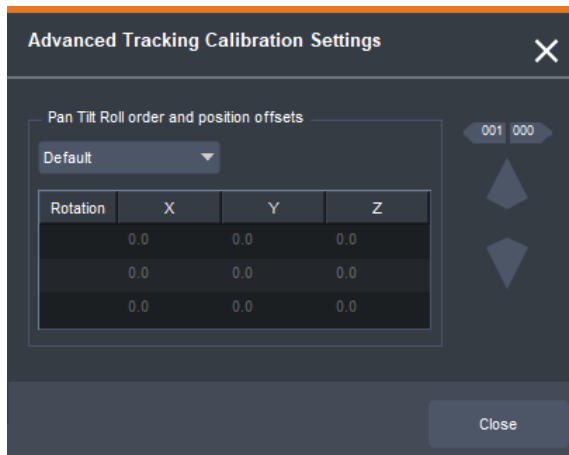

Advanced Tracking Calibration Settings

The table contains **X, Y, Z** values that are possible offsets to be used before applying the next rotation. You can select the order in which the offsets are applied.

For example, in the image below, an offset in the **Z** axis of the **Tilt** rotation will be applied after the **Pan** rotation and before the **Roll** rotation.

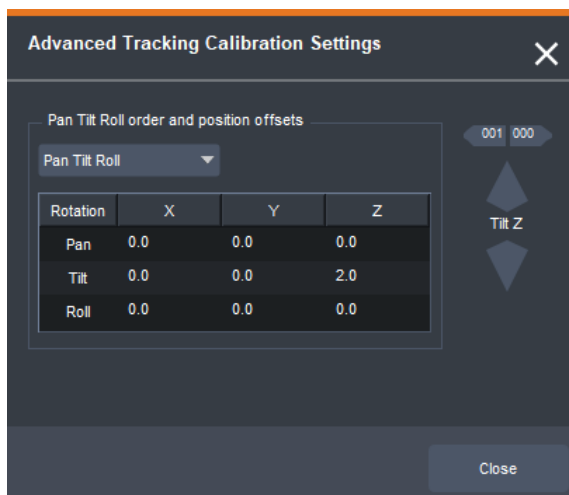

Advanced Tracking Calibration - Tilt Offset

To change the calibration mode and offsets:

1. From the **Rotation** drop-down, select the rotation order.
2. In the **Rotation** table, select the **X**, **Y**, or **Z** column of the camera motion you want to offset and enter the value of the offset.
3. Select **Close** to exit the window.

Pivots

This button opens the **Pivots Values** window.

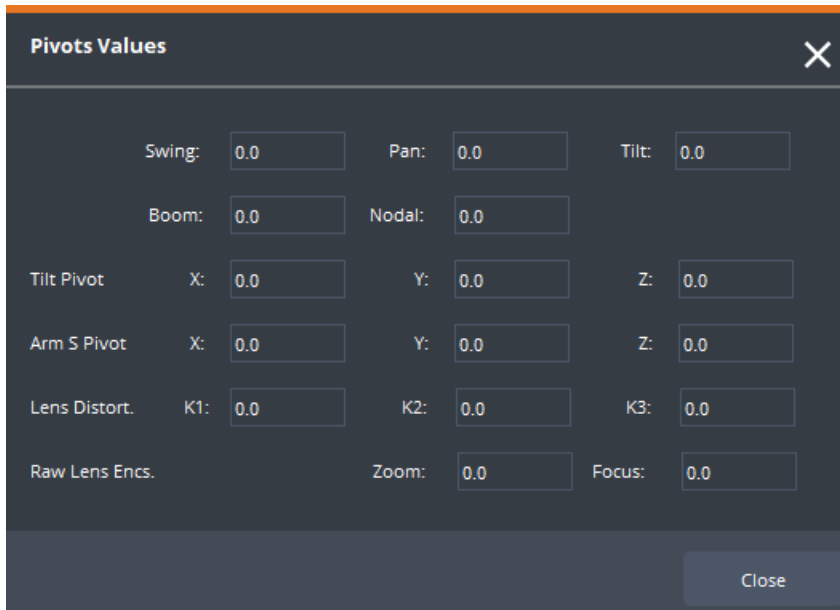

The screenshot shows a window titled "Pivots Values" with a close button (X) in the top right corner. The window contains several input fields for camera motion parameters, all currently set to 0.0:

Swing:	0.0	Pan:	0.0	Tilt:	0.0
Boom:	0.0	Nodal:	0.0		
Tilt Pivot	X: 0.0	Y: 0.0	Z: 0.0		
Arm S Pivot	X: 0.0	Y: 0.0	Z: 0.0		
Lens Distort.	K1: 0.0	K2: 0.0	K3: 0.0		
Raw Lens Encls.		Zoom: 0.0	Focus: 0.0		

A "Close" button is located at the bottom right of the window.

Pivot Values Window

Pivots Values Window

The read-only fields in this window provide additional detail regarding the camera-tracking data. The fields in this window are:

- **Swing, Boom**

For jib-mounts, these fields show the angle values (degrees) coming in for jib-arm swing (Y-axis rotation) and boom (X-axis rotation) respectively. The **Swing** value combined with the **Pan** value, results in the final camera pan angle. The **Boom** angle determines the height of the camera.

- **Pan, Tilt**

These fields show the angle values (degrees) for **Pan** and **Tilt** respectively, before any scaling or offsetting has been applied.

- **Nodal**

The calculated nodal offset from the lens curve.

- **Tilt Pivot X, Y, Z**

The **Tilt Pivot** represents the point of intersection between the **Pan Pivot** and the **Tilt Pivot**. These fields show the camera **X**, **Y**, and **Z** values before any camera offsets or any lens-curve positional shifts are applied.

- **Arm S Pivot X, Y, Z**

For jib mounts, this is the jib arm swing pivot - and represents the intersection of this swing pivot with the jib-arm boom pivot. The **X**, **Y**, and **Z** location of this intersection is typically directly above the jib's floor position - and allows you to confirm that the jib arm's starting height is correct.

- **Lens Distort. K1, K2, K3**

These are distortion coefficients used so the renderer can apply the lens distortion in the final image.

- **Raw Lens Encoders: Zoom, Focus**

These fields show the lens zoom and focus raw encoder values as they come from the lens, before any scaling or offsetting is applied.

LENS INFORMATION

• Lens

Selects the specific lens being used on the selected camera. An extensive matrix of data for each lens in the list has been compiled and stored in the Lucid Studio database. The right lens ensures accurate tracking data.

Hover your mouse over a lens to see a tooltip indicating if that lens contains **Distortion** or **Defocus** information.

You can also add paths to custom lens files if you have them and want to use them. If you choose this option, be sure to add the path or paths to both the Lucid Track where you want to use it and to Lucid Studio (if you're not using a standalone Lucid Track) using the same procedure. The path doesn't have to be the same but the lens file has to be added in both.

If any of the following conditions occur, you will see a warning message.

- Lucid Studio doesn't have one or more lenses that are present in Lucid Track.
- Lucid Track doesn't have one or more lenses that are present in Lucid Studio.
- Lucid Track and Lucid Studio have different versions of the same lens.

Your custom lens file needs to have the extension **.uxl** to be valid.

To use a custom lens file:

1. Select the cog wheel in the bottom-right corner of the **Lens** pane.

This opens the **Lenses Options** window.

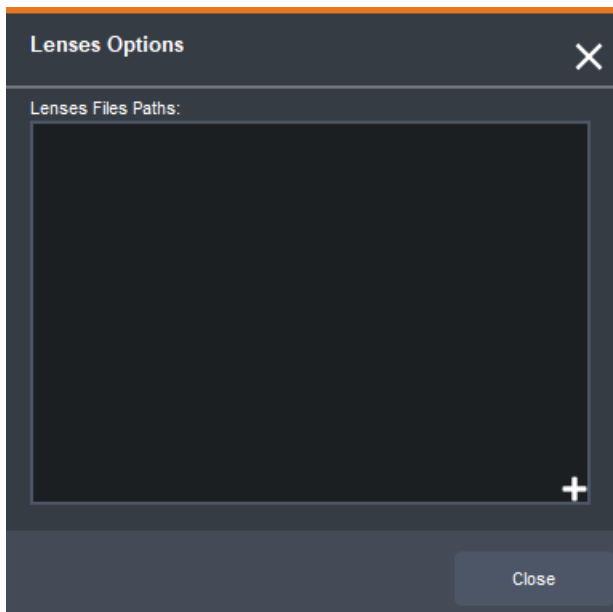

Lenses Options

2. Select the **+** icon in the bottom-right corner of the **Lenses Options** window.

3. In the **Select Folder** window, navigate to the location of your lens file and select **Select Folder**.

The path to your custom lens will appear in the **Lenses Options** window and also in the **Lens** list, from where you can then select it.



Custom Lens Added to Lens List

4. From the **Lens** list, select your custom lens.

The **Lens Changed** dialog opens, asking if you want to apply the default min/max values for **Zoom** and **Focus** encoders.

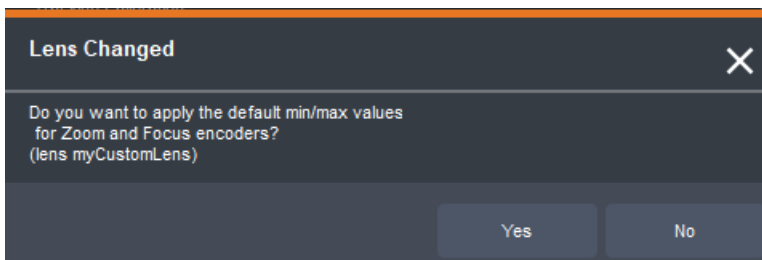

Lens Changed Confirmation

5. Select **Yes** to apply the default values for your custom lens.

- **Lens Distortion**

- Enable**

- Enables lens distortion modeling. This feature can be critical for certain types of lenses or settings, but often is not necessary. Disabling it frees up graphics processor bandwidth for other uses. Default is **Disabled**.

- Hyper Focal Circle of Confusion**

- This value is used for defocus calculations and is dependent on the image size. For 2/3" images, the value is 0.009.

- **CCD Centering**

- Each camera lens has a certain amount of offset from center based on its manufacture and how it is attached to the camera body. For tracking purposes, you need to determine how far it is offset in the X and Y directions from center on the charge-coupled device (CCD sensor) inside the camera.

- X and Y**

- These values are determined using the CCD-Centering process. Once these values are determined, they are entered in their respective fields here.

- Crosshairs**

- This checkbox enables or disables visual crosshairs on the renderer associated with the selected camera. These crosshairs are used in the CCD-Centering process.

- **Zoom Encoder Min-Max Values**

- These two fields are used to enter the minimum and maximum encoder values produced by the

encoded lens on the selected camera. The default values are 0 and 60,000 respectively (Canon) or 0 and 65,530 (Fuji), but these values should be replaced with actual values observed from the lens when it is at the extremes of its zoom range.

These values can be seen in the **Pivot** window.

- **Focus Encoder Min-Max Values**

These two fields are used to enter the minimum and maximum encoder values produced by the encoded lens on the selected camera. The default values are 0 and 60,000 respectively (Canon) or 0 and 65,530 (Fuji), but these values should be replaced with actual values observed from the lens when it is at the extremes of its focus range.

These values can be seen in the **Pivot** window.

- **Value Change Control**

The **Value Change Control** determines the increment by which change is applied for each click of the **Up/Down** arrows.

To use it, select the input field whose value you want to change, select the desired scale value (i.e., how much change should occur for each click of an arrow button - ranging from **0.001** to **100**), and then select the up or down arrow to make the change.

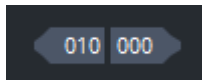

Value Change Control

- **Up/Down Arrows**

These arrows increase or decrease the selected value by the increment chosen in the **Value Change Control**.

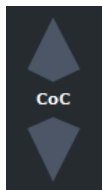

Up/Down Arrows - Lens Information

Track Operate

The Track **Operate** panel allows you to configure the camera position and rotation offsets and the defocus parameters. It also provides a means to store preset floor positions.

[Offsets](#)

[Defocus](#)

[Floor Position Fields](#)

[Floor Presets](#)

Offsets

The **Offsets** button opens a window where you can adjust position and/or rotational offsets. The values are added to their respective global offsets (as configured in the [Set Offsets](#) section of the **Track Setup** panel).

For example, if you establish a 30-degree pan offset in your global offsets, but during a production the camera was bumped and rotated 2 degrees, the operational offsets allow you to quickly make this 2-degree tweak (by entering **2.0** in the **Pan** field) while leaving the calibrated 30-degree offset intact.

The following fields are found in the **Offsets** window:

- **Dolly**

This is an offset along the dolly track (not used with Furio tracking systems).

- **Swing, Elevate**

For jib mounts, offset the jib-arm swing (Y-axis rotation) and jib-arm elevate (X-axis rotation).

- **Extend**

For telescopic jib mounts, offsets the jib-arm extension.

- **Pan, Tilt, Roll**

Offset the three degrees of rotation (Y rotation, X rotation, and Z rotation respectively).

- **X Position, Y Position, Z Position**

Offset the camera location in 3D space.

- **FOV, Zoom, Focus**

Lens-related offsets. The Zoom value offsets the raw encoder count coming from the lens, before any **FOV** (**Field of View**) calculation is performed. The **FOV** value, on the other hand, offsets the calculated **FOV**.

- **Value Change Control**

The Value Change **Control** determines the increment by which change is applied for each click of the **Up/Down** arrows.

To use it, select the input field whose value you want to change, select the desired scale value (i.e., how much change should occur for each click of an arrow button - ranging from **0.001** to **100**), and then select the up or down arrows to make the change.

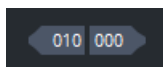

Value Change Control

- **Up/Down Arrows**

These arrows increase or decrease the selected value by the increment chosen in the **Value Change Control**.

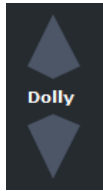

Up/Down Arrows - Tracking Scales

Defocus

The **Defocus** button opens a window where you can configure the defocus parameters. By default, it also tells the driver for the selected camera to begin outputting depth-of-field detail.

The **Defocus Parameters** window includes the following parameters:

- **Enable**

When selected, indicates that the defocus effect is activated.

Default is cleared.

- **Show DOF Marks**

When checked, tells the renderer associated with the selected camera that it should visually display depth-of-field indicators in the scene. Exactly how these indicators appear is renderer-specific, but in general, they allow the user to see how much of the defocus effect is being applied to different parts of the rendered scene.

➤ **Blue** is the far plane, showing where things go out of focus behind the focus point.

➤ **Green** is the near plane, showing where things go out of focus in front of the focus point.

➤ **Black** (in between blue and green) is the actual in focus region.

- **Manual**

Allows you to manually change the lens-related defocus parameters (i.e., **Focus Distance**).

If cleared, these values will be calculated automatically based on the lens-curve data for the lens in use by the selected camera.

- **Circle of Confusion**

Specifies the **Circle of Confusion** value to be used by the renderer's defocus algorithm. In general, the higher this number, the more defocus is applied.

- **Focus Near/Far**

Read-only fields that show the calculated focus range.

The **Near** value indicates the point closest to the camera where objects come into focus.

The **Far** value indicates the furthest point where objects are in focus.

Any objects closer than the **Near** value or farther away than the **Far** value will be blurred based on the defocus algorithm.

- **FNum**

Specifies the **F-Stop** number to use for the focus calculations.

- **Distance Offset**

Specifies an offset to be applied to the entire focus range.

You can use the slider to change the value or enter the value in the corresponding field.

For example, if you set the value to **5.0**, both the near and far values would be offset by 5 feet (or 5 meters, depending on the option chosen in [Units Selection](#)). A positive value will move the focus range away from the camera; a negative value will move it closer.

- **Focus Distance**

If the **Manual** checkbox is checked, this slider allows you to explicitly set the distance to the focus point.

You can use the slider to change the value or enter the value in the corresponding field.

If the **Manual** checkbox is not selected, this slider will be grayed out (unavailable), as the focus distance will be automatically calculated.

Floor Position Fields

Below the **Offsets** and **Defocus** buttons are the position and rotation value fields. These fields allow you to define the position of the base of the physical camera mount within the virtual studio.

- **X, Y, Z**

Specifies the measured floor position of the base of the selected physical camera mount, in the tracked 3D space.

- **P, T, R**

Pan, **Tilt** and **Roll** specify the measured pan, tilt and roll of the base of the selected physical camera mount, in the tracked 3D space.

- **Value Change Control**

The **Value Change Control** determines the increment by which change is applied for each click of the **Up/Down** arrows.

To use it, select the input field whose value you want to change, select the desired scale value (i.e., how much change should occur for each click of an arrow button - ranging from **0.001** to **100**), and then select the up or down arrows to make the change.

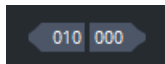

Value Change Control

- **Up/Down Arrows**

These arrows increase or decrease the selected value by the increment chosen in the **Value Change Control**.



Up/Down Arrows - Floor Positions

Floor Presets

In the **Floor Presets** pane you can add the floor position you defined above as a preset, to be able to recall it when needed.

Adding a floor preset can only be done with **Administrator** privileges. See [Users](#) for information about user privileges.

To add a floor preset:

1. Select the **+** icon in the lower-right corner of the **Floor Presets** pane.

If the **+** is not there, you are not logged in as an administrator.

The **New Floor** window opens.

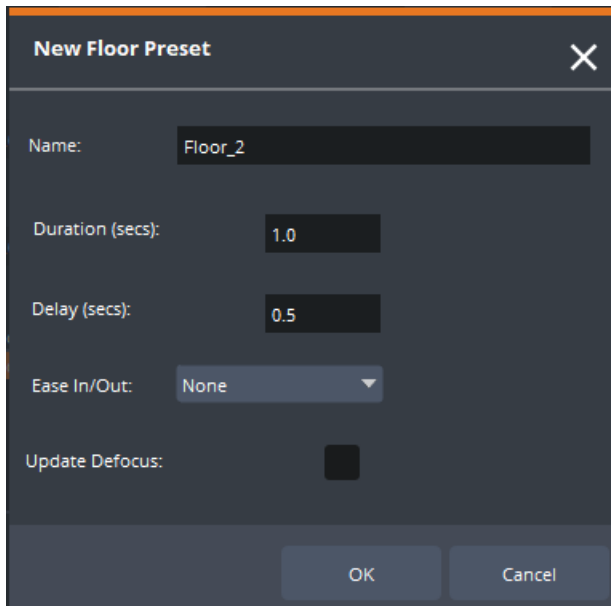

Add Floor Preset

2. Enter the following information:

- **Name**

Contains a default name of Floor_X (where X is a number that represents the count of the number of floor presets). Replace this default name with a name of your choosing.

- **Duration (secs)**

Specifies the duration for an animated move from the camera's current position to this preset position.

If, for example, you enter 2.0 in this field, then whenever this preset is recalled, the camera will take two seconds to get to this position from wherever it is.

- **Delay (secs)**

Specifies a delay to be applied before the camera moves from its current position to this preset position.

If, for example, you enter 3.0 in this field, then whenever this preset is recalled, the camera will remain in its current position for three seconds before beginning its move to this position.

- **Ease In/Out**

Selects an easing algorithm to be used when a camera is animated from its current position to the new one.

Without any easing applied, the camera will move at a consistent speed from point A to point B. This can result in animations that look somewhat abrupt at the start and end of the movement. If you apply easing, the camera will gradually accelerate from a standstill at the start, and decelerate to a stop at the end of the animated movement.

- **Update Defocus**

When selected, indicates that the preset should also capture the parameters that control the defocus effect.

3. Select **OK** to save the preset.

To edit a floor preset:

1. Right-click on the floor preset name.

2. Select **Edit**.

3. In the **Update Floor Preset** editor, change the settings as needed.

4. From the **Update** drop-down, select one of the following options:

- **Nothing**: All properties will stay the same.
- **Transformation**: The XYZPTR values will be updated as well as any changes to the Duration, Delay and Ease In/Out values.

5. Select **OK** to save your changes.

To recall a floor preset:

- Double-click the name of the floor preset you want to use.

To delete a floor preset:

1. Right-click on the preset name.

2. Select **Delete**.

In the confirmation dialog, select **OK** to delete the preset.

Track Grid

In the **Track Grid** panel, you can define your studio space and see a visual representation of the space displayed in a [grid](#).

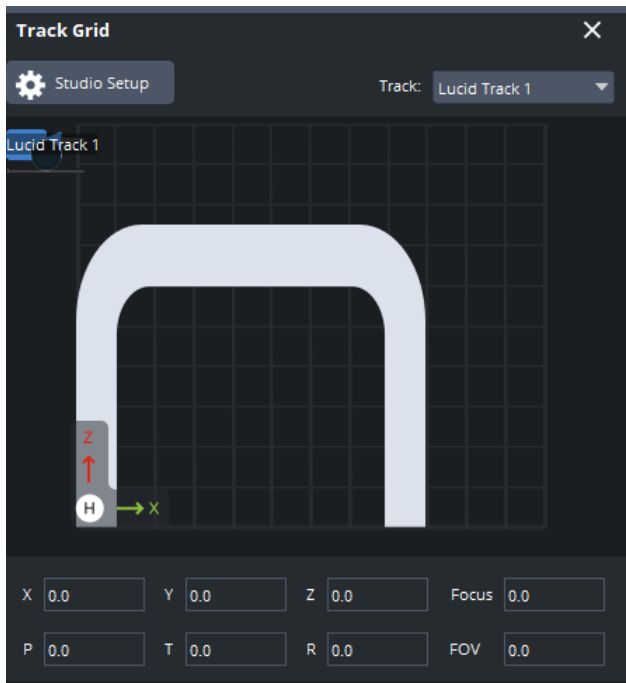

Track Grid Panel

Studio Setup

The **Studio Setup** button opens a tool in which the physical studio space can be defined. Studio settings do not affect calibration or how data is calculated. The following information can be entered:

- **Studio Dimensions**

Maps the size (in X, Y, and Z dimensions) of the physical studio to the feedback grid.

- **Grid Unit Size**

The size of the grid.

- **Cyc Size**

Defines the size (X, Y, Z) of the cyclorama.

- **Cyc Shape**

Selects the shape of the cyclorama. A top view of the cyclorama will be reflected in the feedback grid.

- **Studio Offset**

Specifies the zero position of the studio (in X, Y coordinates) relative to the back left corner of the room.

- **Cyc Position**

Specifies the X and Z coordinates of the cyclorama's back left corner.

- **Value Change Control**

The **Value Change Control** determines the increment by which change is applied for each click of the **Up/Down** arrows.

To use it, select the input field whose value you want to change, select the desired scale value (i.e., how much change should occur for each click of an arrow button - ranging from **0.001** to **100**), and then select the up or down arrow to make the change.

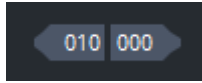

Value Change Control

- **Up/Down Arrows**

These arrows increase or decrease the selected value by the increment chosen in the **Value Change Control**.



Up/Down Arrows - Studio Setup

Grid

The grid displays a representation of the tracked space with the cyclorama positioned and shaped as specified. It also shows the real-time position of the selected camera within the space (shown as a blue icon).

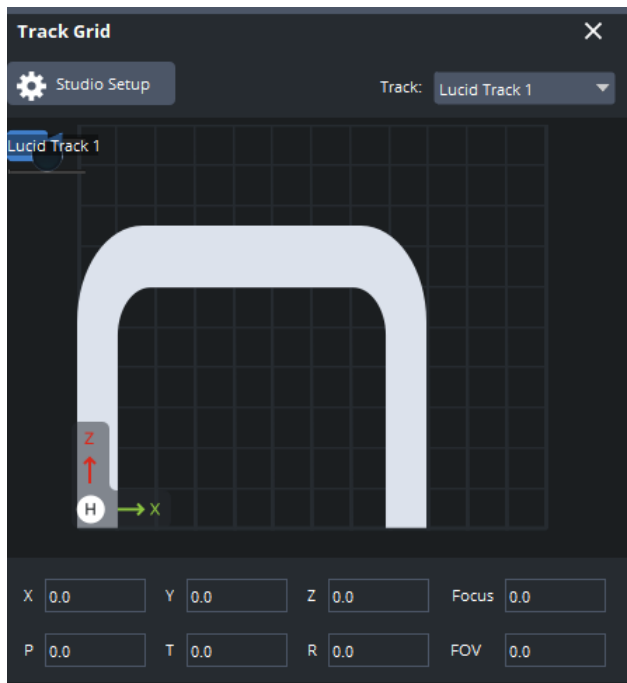

Grid

Beneath the grid are read-only data fields that provide the following real-time feedback:

- **X, Y, Z**

The calculated final camera position being sent to the renderer.

- **P, T, R**

The calculated final camera rotation (**Pan, Tilt, Roll**) being sent to the renderer.

- **Focus, FOV**

The lens' focus value and calculated **FOV** of the camera being sent to the renderer.

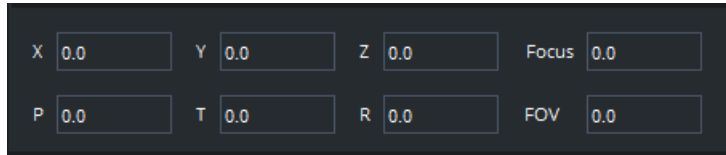

Data Fields

Track Stats

The **Track Stats** panel provides a live visual of the following information:

- Camera Positions (X, Y, Z)
- Camera Rotation (X, Y, Z)
- Field of View (FOV)
- Focus
- Camera Reception Interval (the amount of time elapsed between two data packets coming in or out. At 50fps we receive one tracking packet every ~20ms and for 59.94fps this interval is ~16ms.)
- Values Calculation Interval (how quickly the data is being calculated)
- Values Sending Interval (how quickly the camera data is going out)

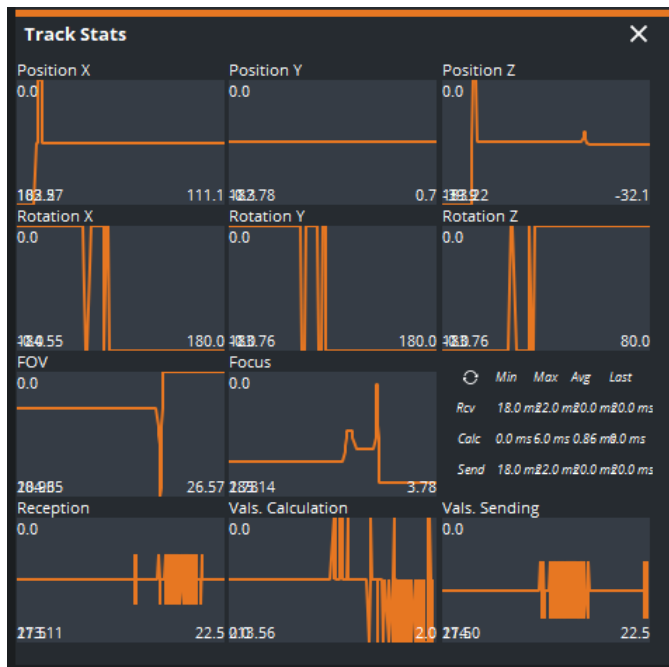

Lucid Track - Track Stats

This window is useful for troubleshooting purposes. Anomalies in performance can be seen as spikes in the graphs in the various panes, indicating an unusual change in normal operation. If you have **Track Anomaly Filtering** enabled in the tracking protocol **Setup** section, these spikes will get smoothed out, but will be marked with a red dot to indicate that they occurred.

Selecting the **Reset** button resets the interval graphs. You might want to do this if there has been a spike for some reason and you want to check if it will happen again or pinpoint where it is happening.

For best performance, close this window when in production.

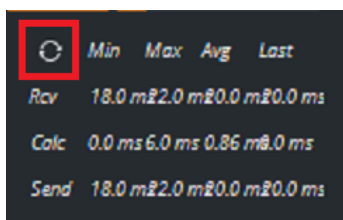

Track Stats Reset Button

Log

The log panel provides operational information in the form of log entries.

- Green text indicates normal activities.
- Orange text indicates a warning about something less serious than red text.
- Red text indicates unsuccessful connections or operations.

To manage the log:

1. Add the **Log** panel to the UI.

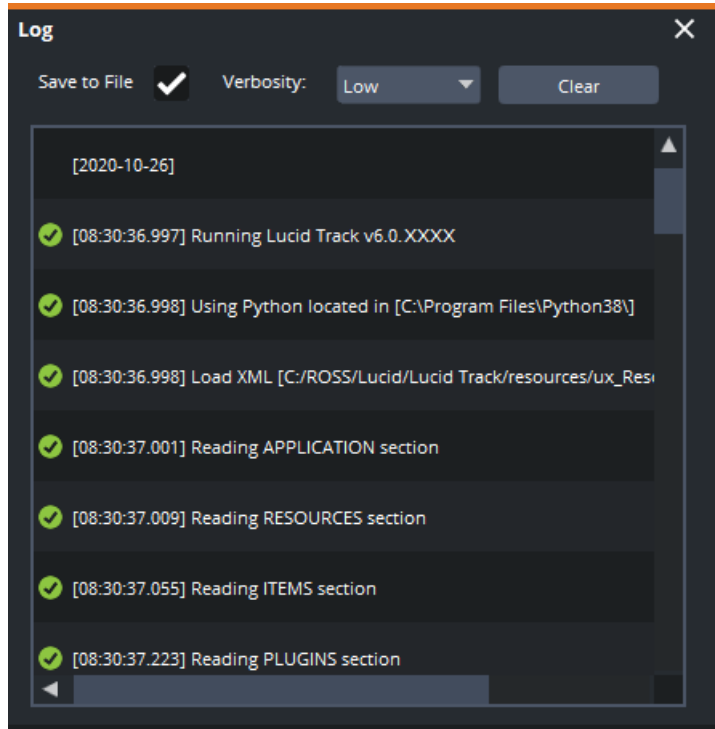

Log Panel

2. Select from the following options:

- **Save to File** — to date-stamp and save a copy of the current contents of the log in the Lucid Track folder (optional but useful when seeking assistance from Technical Support).

The default location is **C:\ROSS\Lucid\Lucid Track**.

The log file is called **LucidTrack_Log_date_time.log**.

- **Verbosity** — to select how much detail you want to see in the log.

At any time, you can select the **Clear** button to clear the contents of the log panel.

Customizing and Managing Layouts

You can customize the Lucid Track layout, save and edit your layouts and create multiple layouts to suit your needs, as described in the following sections:

Customizing Layouts

Managing Layouts

Customizing Layouts

When you first launch Lucid Track, it opens with as much of the default layout as fits on the screen. Thereafter, when you launch Lucid Track, it will open with the last selected layout. Each panel occupies one or more cells, depending on its size. You can change the layout of the UI by adding or removing panels and resizing or rearranging panels.

To add a panel to the layout:

1. Select a panel in the left-hand column and drag it into the layout where you want it.

As you drag the panel into the layout, a grid of cells is highlighted.

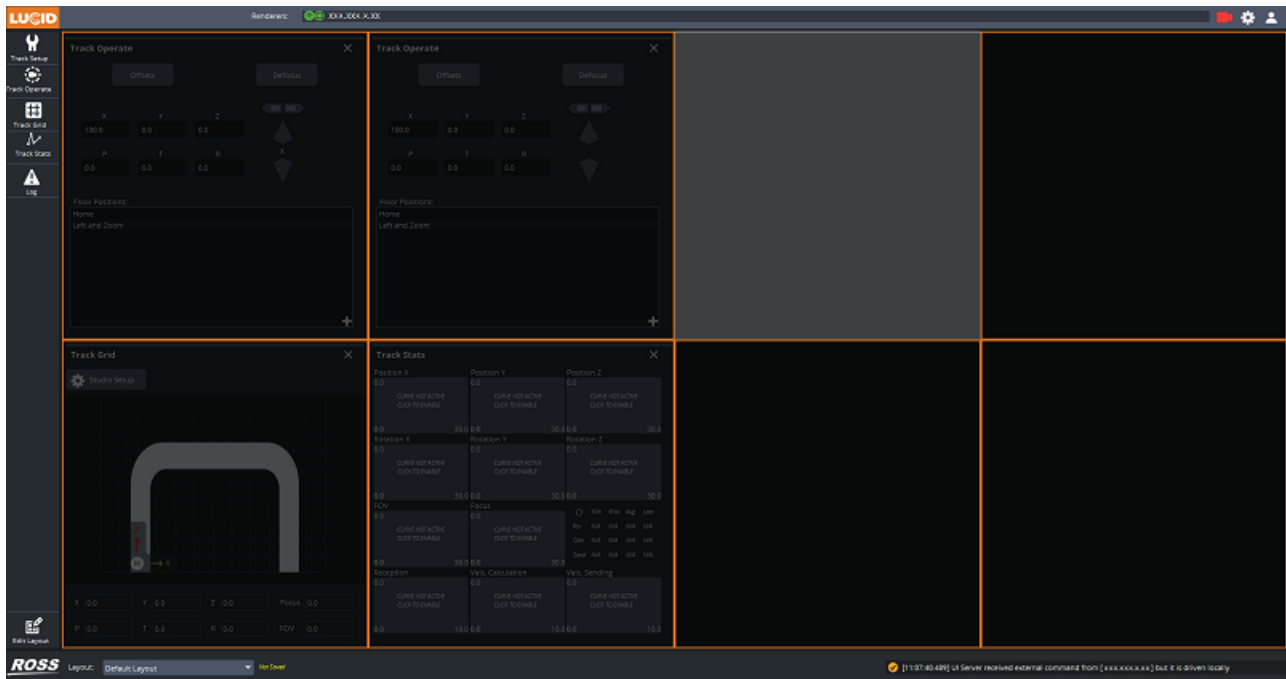

Edit Layout

2. Drag the panel into an empty cell.

If you drag the panel on top of another panel, the original panel will be removed.

To remove a panel from the layout:

- Select the **X** in the top-right corner of the panel.

To make a panel larger:

1. Select the **Edit Layout** button in the bottom-left corner of the UI.

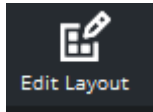

Layout Button

A grid of cells is highlighted.

2. Select a corner square of the panel you want to re-size and drag it through the adjacent empty cell(s).

If there are no corner squares, it's because making that panel larger wouldn't provide any benefit.

A panel can take over any number of cells. If you drag it over a cell that already contains a panel, the original panel will be shifted right into an empty cell or if the panel you are making larger is taking over all the cells, the original panel(s) will be removed.

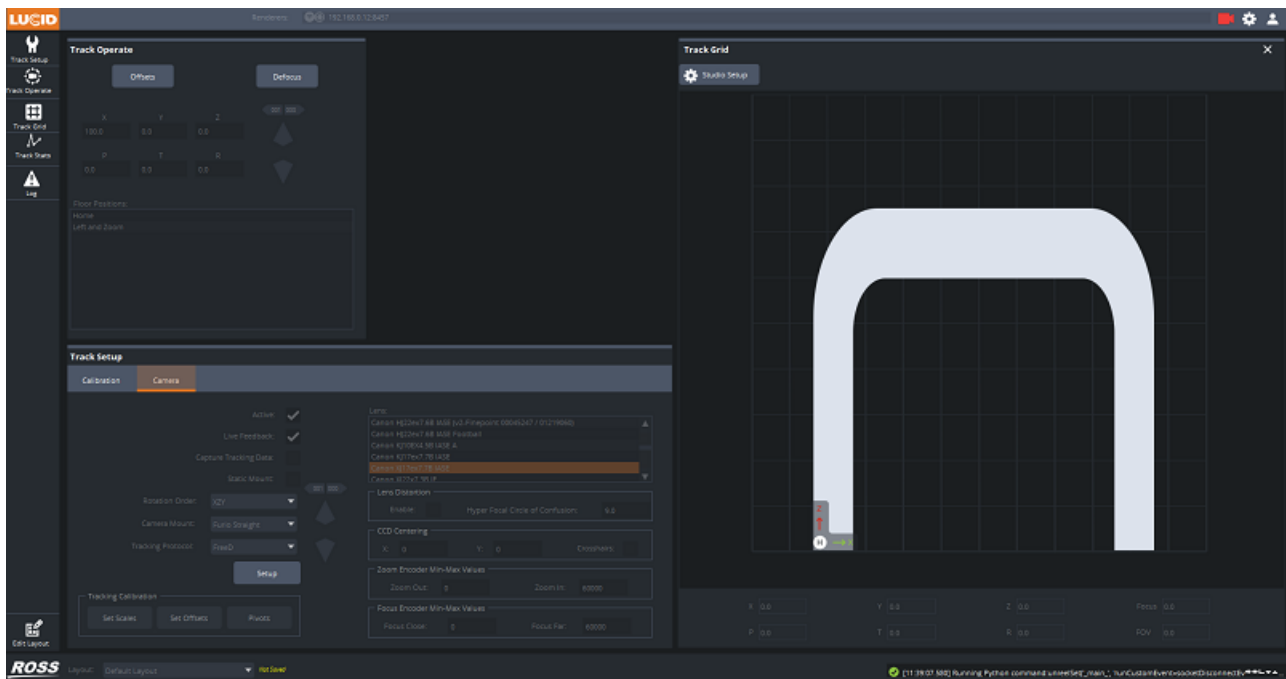

Resizing Panels

To rearrange panels:

1. Select the **Edit Layout** button in the bottom-left corner of the UI.

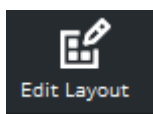

Edit Layout Button

A grid of cells is highlighted.

2. Left-click the **Move** icon  in the center of the panel and while holding the mouse button down, drag the panel to a different cell and release the mouse button.

Managing Layouts

Once you've customized your layout you can save it for future use and then edit it, when necessary. You can also

create multiple layouts. Save a layout anytime you make changes to it.

To save a layout:

1. From the **Layout** drop-down below the grid, select **Save Recent Changes** .
2. If this is the first time you are saving a layout, in the **Save Layout As** window, enter a name for the layout and select **OK**.

Thereafter, selecting **Save Recent Changes** will save the changes to the currently selected layout.

To select a saved layout:

- From the **Layout** drop-down below the grid, select the layout you want.

To discard changes to a layout:

- From the **Layout** drop-down below the grid, select **Discard Recent Changes**.

To edit a layout name or delete a layout:

1. From the **Layout** drop-down below the grid, select the layout you want to edit or delete.
2. Then from the drop-down, select **Edit Layout**.
3. In the **Edit Layout** window, enter a new name for the layout and select **OK**.

OR

Select the **Delete** button to remove the layout and in the confirmation dialog, select **OK**.

To add a new layout:

1. From the **Layout** drop-down below the grid, select **Save Layout As**.
2. In the **Save Layout As** window, enter a name for the layout and select **OK**.

Lucid Studio

The Lucid Studio interface is designed to simplify setting up and operating a virtual studio. Lucid Studio also provides the ability to assign any Lucid Track (camera) to any renderer at any time, so the final camera values can be reassigned. Each Lucid Track can be controlled manually but Lucid Studio makes camera control a single interface operation, thereby reducing workloads.

Lucid Studio also has remote server capabilities that allow it to control other instances of Lucid Studio on other machines.

Launching Lucid Studio on Custom Hardware

The first time you launch **Lucid Studio**, the **Windows Security Alert** message appears and **Windows Defender Firewall** will block the application. This message does not appear on hardware provided by Ross Video.

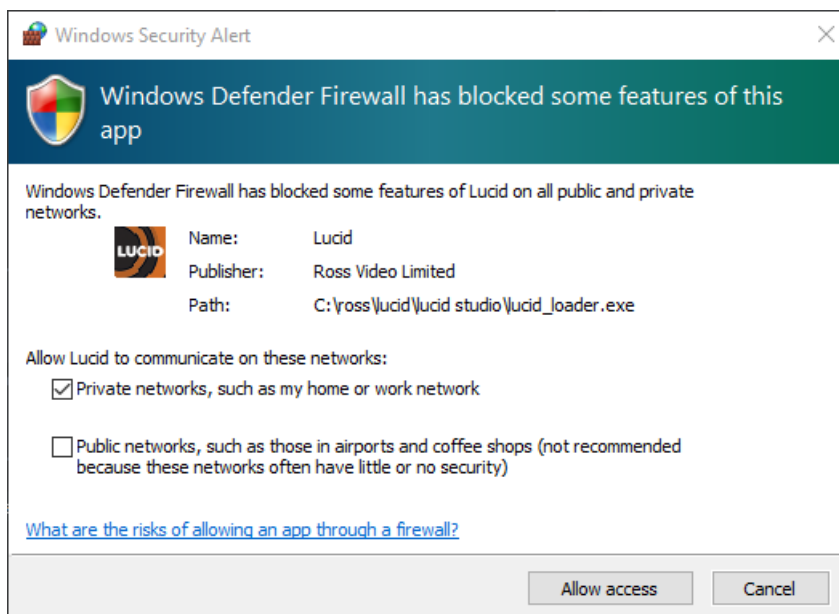

Windows Security Alert

To unblock Lucid Studio:

1. In the **Allow Lucid to communicate on these networks:** section, select **Private networks**.
2. Then select **Allow access**.

You won't see this message again.

Exploring the Lucid Studio Interface

This section provides an overview of the Lucid Studio user interface, with links to more information and instructions.

The Lucid Studio fully licensed interface at startup can be seen in the figure below.



Lucid Studio User Interface

Settings

When launching Lucid Studio for the first time, you'll need to configure the Lucid Studio settings.

The settings are accessed by selecting the gear icon in the upper-right corner of the user interface.

For information about setting up Lucid Studio, see [Setup](#).

Renderers and Tracks

At the top of the screen, there are two read-only fields, displayed side-by-side that indicate which Lucid Tracks and renderers are active and what their status is. Hovering over the item with your cursor will display a tooltip with the engine, version and status. If either field is full, you can scroll to view the remaining renderers or tracks.

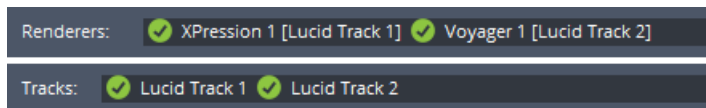

Renderers and Tracks

For information about adding renderers and Lucid Tracks, see [Server](#).

Panels

The Lucid Studio user interface has a dynamic layout that can be customized to include any or all of the panels listed in the left-hand column.

For information about each panel, see:

[Server](#)

[Track Setup](#)

[Track Operate](#)

[Track Grid](#)

[Position](#)

[Events](#)

[Sequencer](#)

[Router](#)

[Logic](#)

[Web](#)

[Chroma](#)

[Color Correction](#)

[Video Walls](#)

[Log](#)

Layout

In the bottom-left corner of the user interface is the **Edit Layout** button. This feature allows you to add the panels you need to the layout, make some panels larger and rearrange them as desired.

The **Layout** drop-down provides options for saving and discarding changes to the layout, changing the layout name, and saving the layout with a new name.

For information about layouts, see [Customizing and Managing Layouts](#).

Log

In the bottom-right corner of the UI, the last line of the log is displayed. To view more of the log entries, double-click this line. This opens up a replication of the **Log** panel.

For information about the **Log** panel, see [Log](#).

Setup

The settings are configured in the **Setup** tool, which is accessed by the small gear icon, located in the upper-right corner of the UI. In the **Setup** tool you can save or back up your track configuration and Lucid project files, set network-related and other configuration information, connect to DashBoard and manage users.



Lucid Studio Setup Tool Location

The **Setup** tool contains several tabs, as shown below:

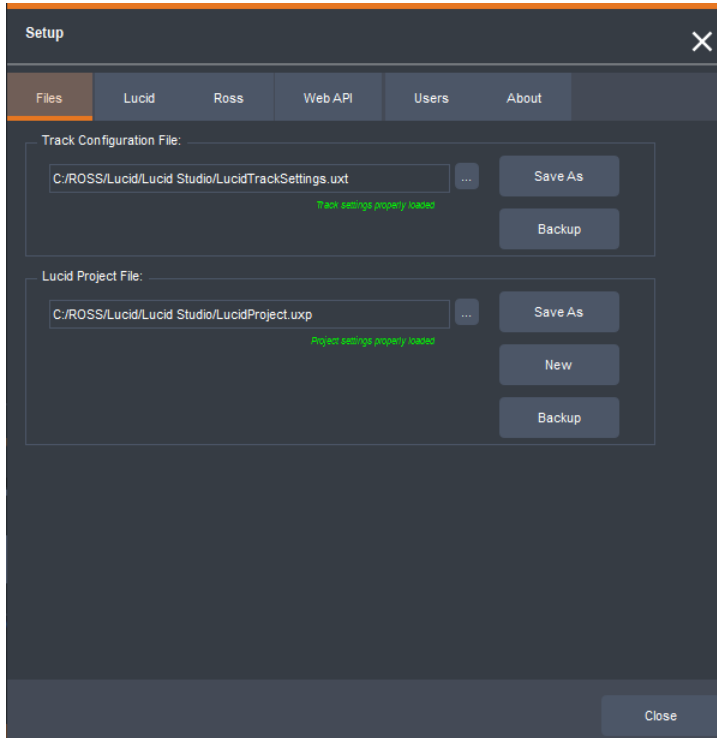

Lucid Studio Setup Tool

The **Setup** options are described in the following sections:

[Files](#)

[Lucid](#)

[Ross](#)

[WebAPI](#)

[Users](#)

[About](#)

Lucid

In the **Lucid** tab, you can configure the default communication and display settings.

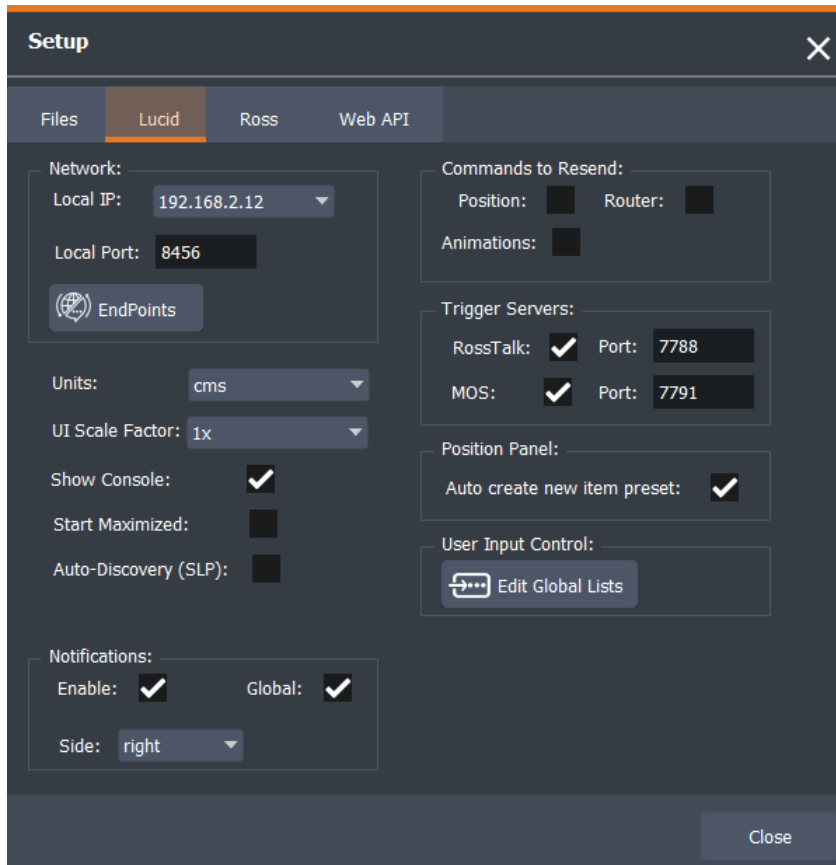

Lucid Studio Setup - Lucid Tab

The **Lucid** tab settings are described below:

• Network Settings

- **Local IP** displays a list of the available IP addresses in the system. All Lucid Tracks, Lucid Studio, renderers and cameras need to be on the same subnet.

An IP address is a numerical identifier that is recognized by networked devices such as servers and computers, and this is how websites and other internet locations are uniquely identified.

- **Local Port** is where you can change the listening port number, if the default port is in use.

The default port is **8454**.

The **Local IP** address and **Local Port** must be identified, given that you can have multiple networks. For example, a world wide network and an internal user network.

These fields are automatically populated with default values, which include local IP addresses available in the system running Lucid Studio.

• EndPoints

Select **EndPoints** to assign IP addresses for use in a specific situation, such as a trade show or studio. The assignment can then be called from a [Send](#) or [Robotics](#) action event. You can also create **Presets** to quickly recall an **EndPoint** when needed.

See [EndPoints](#) for further information.

☒ Units Selection

The **Units** drop-down allows you to specify the units that will be used for measuring positional offsets and other linear measurements, either inches or centimeters.

- **UI Scale Factor**

When using a larger monitor, select from this drop-down to increase the size of the UI, up to twice as large (for example, when using a 4K monitor).

★ If you change the **UI Scale Factor**, you will need to restart Lucid Studio for the setting to take effect.

- **Show Console**

Select the **Show Console** checkbox to keep the log window open or clear the checkbox to close the window. The window can be minimized.

- **Start Maximized**

Select the **Start Maximized** checkbox to launch Lucid Studio in fullscreen mode.

- **Auto-Discovery (SLP)**

Select the **Auto-Discovery** checkbox to allow Lucid Studio to automatically detect any Lucid Tracks or renderers on the network.

When checked, DashBoard will also be able to automatically detect Lucid Studio. If unchecked, you will need to set up the connection to Lucid Studio in DashBoard manually. See [Connecting Lucid Studio to Dashboard Manually](#).

If **Auto-Discovery** is not detecting Lucid Tracks or renderers on the network or Lucid Studio is not being detected by DashBoard, you can test **SLP** using the procedure outlined in [Appendix B: Testing SLP](#).

- **Notifications**

When enabled, important notifications such as successful (or unsuccessful connections) will be displayed.

- If the **Global** checkbox is selected, the notifications appear on the Windows desktop.
- If the **Global** checkbox is not selected, the notifications will appear on the Lucid Studio UI.

From the **Side** drop-down, you can select whether you want the notifications to appear on the left or right side of the screen.

- **Commands to Resend**

The **Commands to Resend** list allows you to select which type(s) of commands you want to resend automatically when a renderer is relaunched. Only those commands selected will be resent when the renderer is relaunched.

- Select a command type to select it.
- Select the command type again to deselect it.

The following commands can be automatically resent:

- **Position**
- **Router**
- **Animations**

- **Trigger Servers**

Selecting the **RossTalk** or **MOS** checkbox triggers the creation of a server on the corresponding port.

The default state is selected.

The default ports are: **RossTalk**: 7788 and **MOS**: 7791

- **Position Panel**

Selecting the **auto create new item preset** checkbox will generate a preset of the current position of any item added to the **Position** panel.

- **User Input Control**

Selecting the **Edit Global Lists** button allows you to create, import or edit a list from which to select text to add to a scene. The **Global List** is available to all text items and to the **User Input Control Global Lists** logic node. For more information see: [User Input Control](#).

Files

The **Files** tab contains two fields with adjacent **Browse** buttons for navigating to the **Track Configuration File** and the **Lucid Project File** respectively.

- The **Track Configuration File** contains information about the way you've configured the tracking-related settings in Lucid Studio. The main reason for storing tracking settings is to accommodate multiple sets within the same studio.
- The **Lucid Project File** is the file produced by Lucid Studio itself and contains all project related information and settings, like objects to control, events, router sources and targets, logic scripts, and more. Each Voyager or XPression project will have its own Lucid Project File.

To open a project file:

1. In the **Files** tab, select the **Browse** button beside the **Lucid Project File** field and browse to and select your project file.

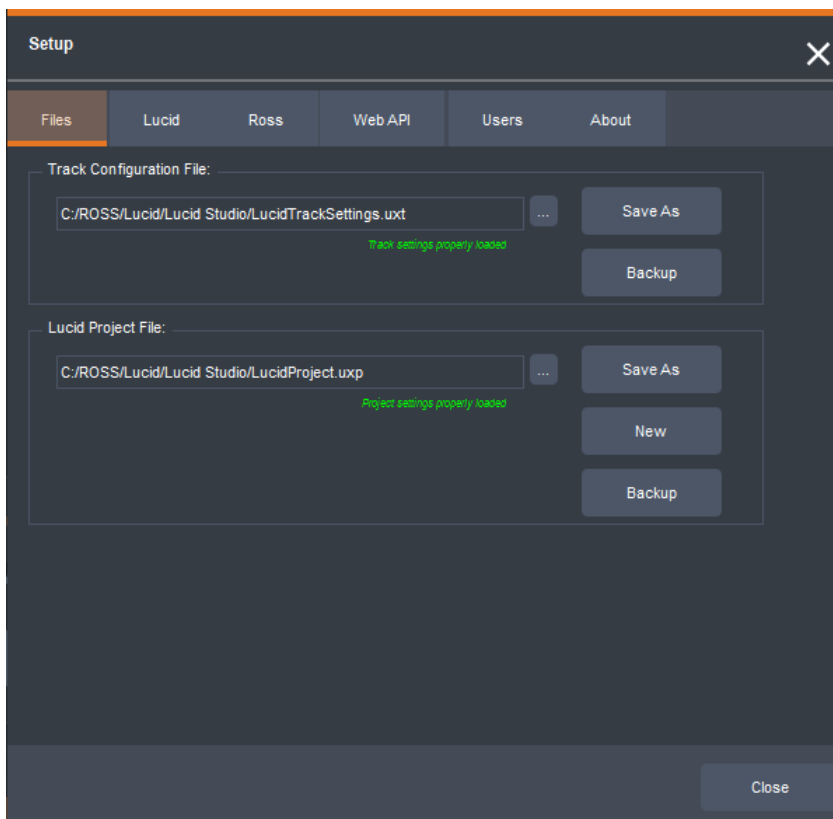

Lucid Studio Setup - Files Tab

If there are items in the project with duplicate internal names, a notification appears warning that duplicate names exist.

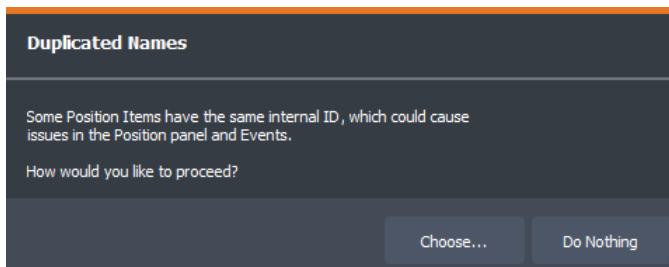

Duplicated Names Notification

2. Select **Choose** to open the **Duplicated Names - Remove References** dialog.

★ If you select **Do Nothing**, the following dialog appears, warning that doing nothing could cause some issues in the project. Select the warning to close the dialog.

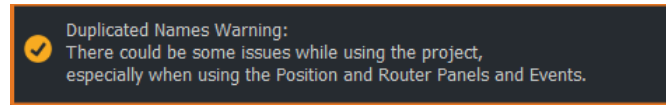

Duplicated Names Warning

If you select **Choose**, the **Duplicated Names - Remove References** dialog opens with a list of the **Internal Names** that are duplicated and the name of the item as it appears in the UI, along with the location of the item.

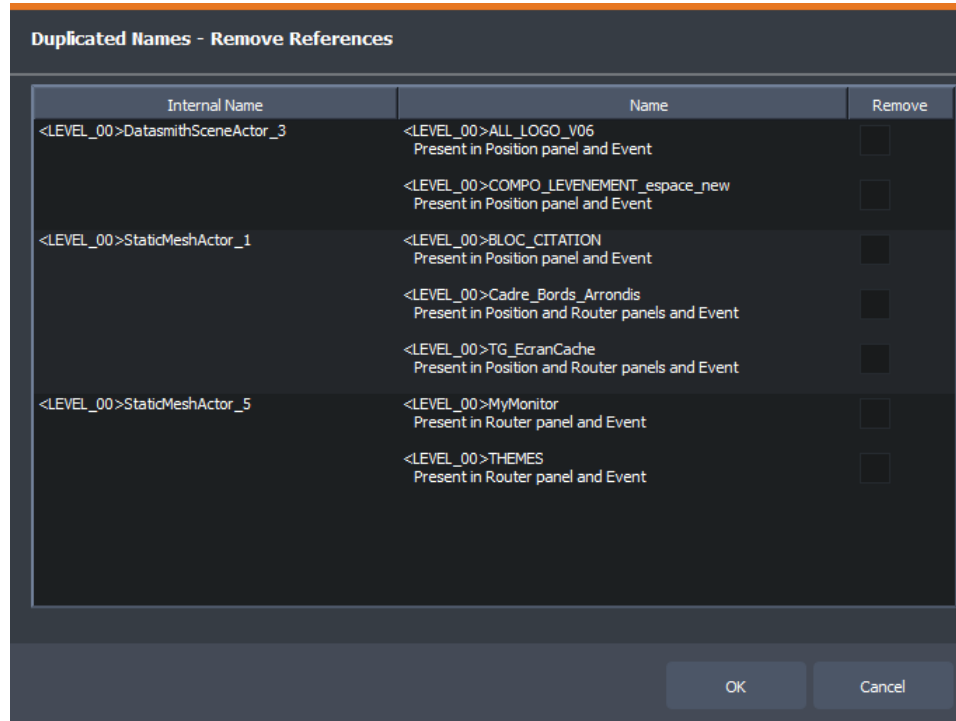

Duplicated Names - Remove References

3. Select the checkbox beside each item you want to delete, leaving only one item for each internal name.

4. Then select **OK**.

To save a track configuration file with a different name:

1. Select the **Browse** button beside the **Track Configuration** file or **Lucid Project File** field to navigate to the folder in which the file is stored.

2. Select **Save As** to give the file a recognizable name and save it to the default location: **C:\ROSS\Lucid\Lucid Studio**.

Any configuration changes made are automatically saved to the current file.

To save a backup file:

- Select **Backup** to save a copy of the file that is dated and time-stamped.

The backup file has the extension **.uxt.backup**.

If you later need to restore your settings by loading the backup file, a copy of the file is loaded and the original backup remains.

To create a new project file:

1. In the **Lucid Project File** section, select **New**.
2. In the **New File** window, in the **File name** field, enter a name for the new project and select **Save**.

The new name appears in the **Lucid Project File** field and a blank project is created.

Automatic Backup

On the rare occasion that data in the LucidProject.uxp file does not reflect the latest changes, a backup of the outdated file (LucidProject_outdated.uxp) is automatically created and saved in C:/ROSS/Lucid/Lucid Studio and the current file is fully updated. If this happens, you will see the following notification:

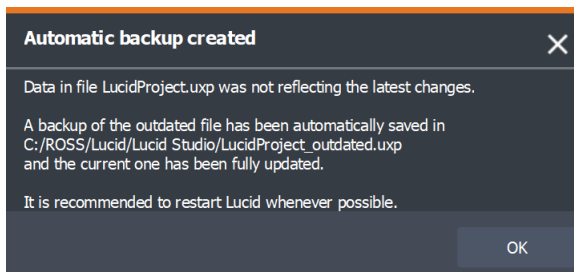

Automatic Backup Notification

- ★ Restart Lucid as soon as possible, if you see this notification.

Ross

The **Ross** tab provides the ability to use DashBoard (in read-only mode) to execute events and recall existing position presets. Any events and positions created in Lucid Studio will appear in the DashBoard panel and the panel will be updated automatically as changes are made in Lucid Studio.

DashBoard is an open platform tool for creating custom workflows to control IP-based devices and can be used with most Ross Video products. It is available for download (free) from the Ross Video website.

See [DashBoard](#) for more information.

In this tab, you can also enable Streamline integration, allowing you to browse assets within a Web panel, and drag assets from Streamline into the Router panel and apply them to targets. You can also drag Streamline assets from the Web panel into the Sequencer panel and onto Event buttons to be used as thumbnails.

Streamline is an asset management system that allows you to quickly search and find graphics to use in your Voyager projects. It is available by license from Ross Video.

See [Streamline](#) for more information.

You can also access a DataLinq source from the Ross tab, allowing you to update data in the **Position**, **Events** and **Sequencer** panels. See [Data Linq](#) for more information.

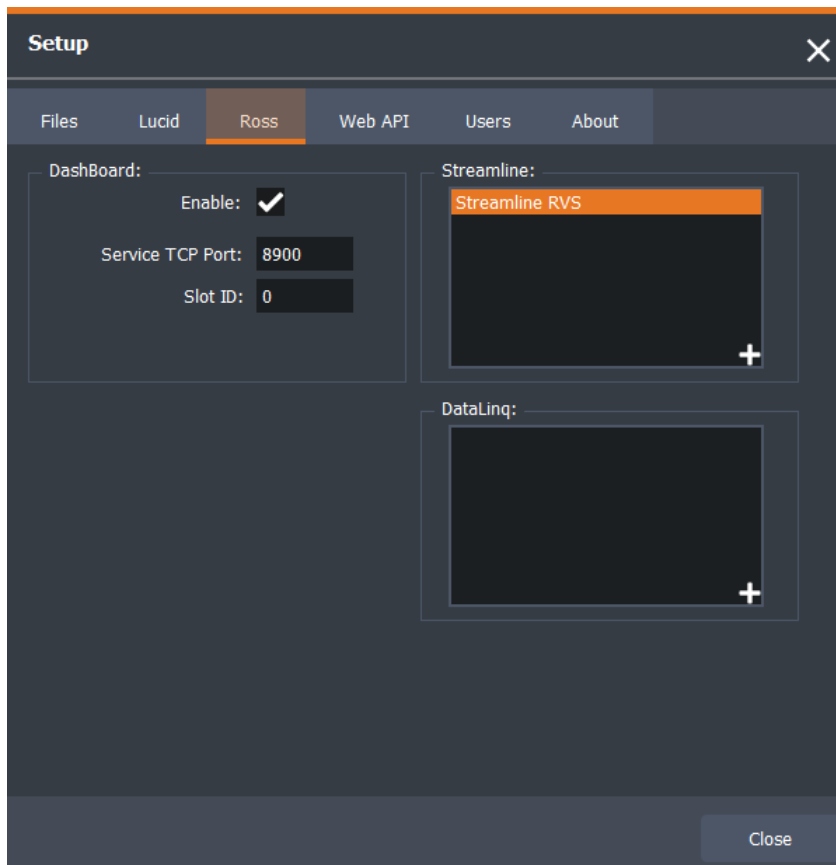

Lucid Studio Setup - Ross Tab

DashBoard

Use a DashBoard panel to execute events and recall presets.

To use DashBoard:

1. Select the **Enable DashBoard Support** checkbox.
2. In the **Service TCP Port** field, accept the default port of **8900**, or if that port is in use, enter a different port number.
3. In the **Slot ID** field, enter a number to identify the instance of Lucid Studio in DashBoard, if you have more than one instance.

By default, "0" is entered in this field. If you only have one instance of Lucid Studio, there's no need to change this.

4. If a **Windows Security Alert** message opens, select the appropriate network and select **Allow access**.

Connecting Lucid Studio to Dashboard Manually

If you didn't select the **Auto Discovery (SLP)** option in the **Ross** tab of the Lucid Studio Setup tool, you can also connect to DashBoard manually, following the instructions below:

To connect Lucid Studio to DashBoard:

1. Launch Lucid Studio as usual.
2. Launch DashBoard from the desktop icon.
3. Select the **Add New Connection** button in the **Basic Tree View** toolbar.

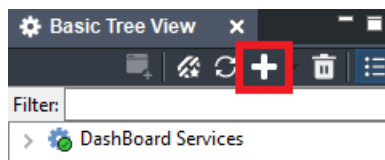

DashBoard Interface - Add Button

The **Select Equipment or Service Type to Add** window opens.

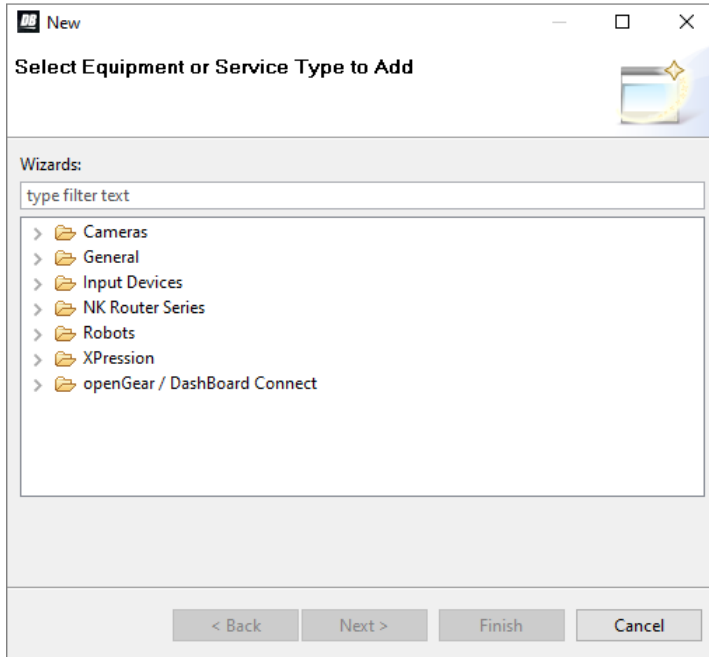

DashBoard - Select Equipment or Service Type to Add

4. Expand the **openGear / DashBoard Connect** folder.
5. Select **TCP/IP DashBoard Connect or openGear Device** and select **Next**.

The **TCP/IP DashBoard Connect/openGear Device** window opens.

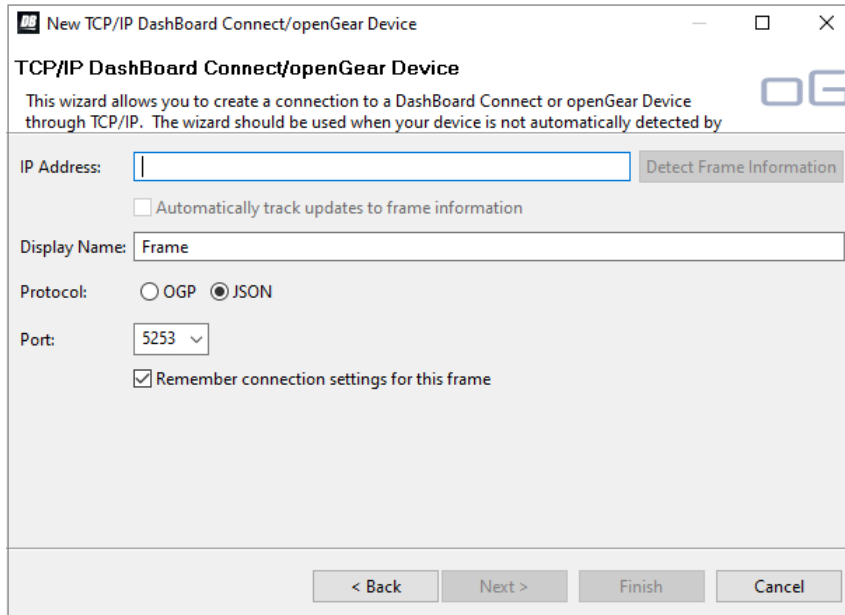

TCP openGear Frame Connection Window

6. In the **IP Address** field, enter the IP address of the computer running Lucid Studio.
Do not select **Detect Frame Information**.
7. In the **Display Name** field, enter Lucid Studio.
8. Select the **JSON** Protocol option.

9. Set the **Port** to the **Service TCP Port** number entered in the **Lucid Studio Setup > Ross tab > Dashboard** settings in Lucid Studio.

10. Select the **Remember connection settings for this frame** checkbox and then select **Finish**.

In the **Basic Tree View**, you'll see that Lucid Studio as been added to the list.

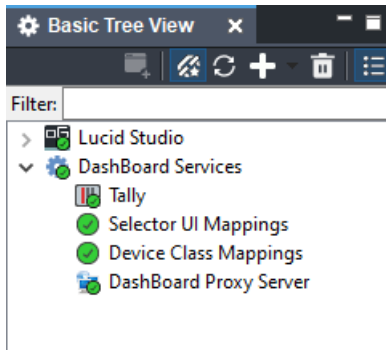

Lucid Studio in Dashboard Tree View

To open the Events and Position panels:

- Expand the Lucid Studio node and double-click the Lucid Studio openGear item.

The Dashboard panel is created automatically when connecting to Lucid Studio and populated with any events or positions that have been set up in Lucid Studio.

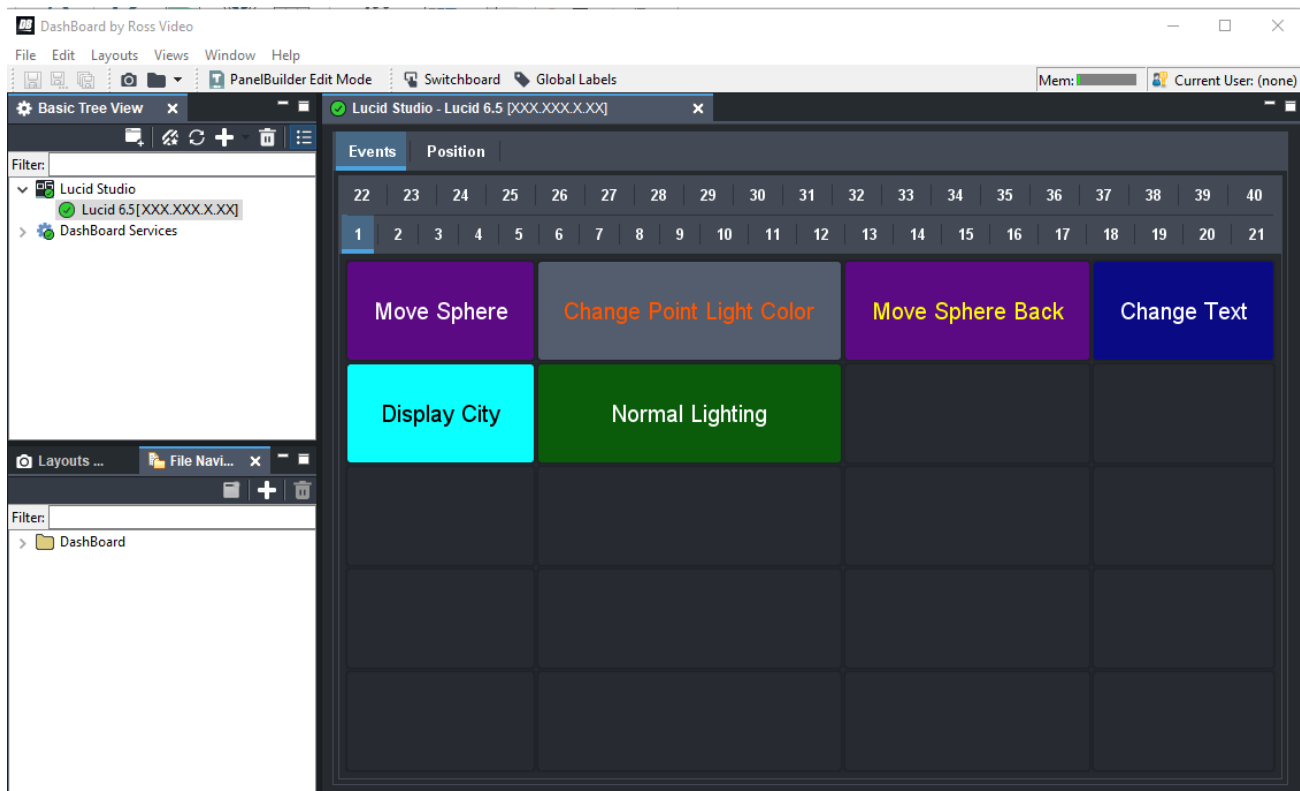

Dashboard Lucid Studio Panel

Streamline

Use Streamline in the **Web** panel to browse assets and insert them into other panels in Lucid Studio.

This feature is compatible with Voyager versions 4.26 and newer.

To configure Streamline:

1. In the Streamline section of the **Ross** tab, select the **+** icon in the bottom-right corner of the pane.
2. The **New Streamline Server** window opens.

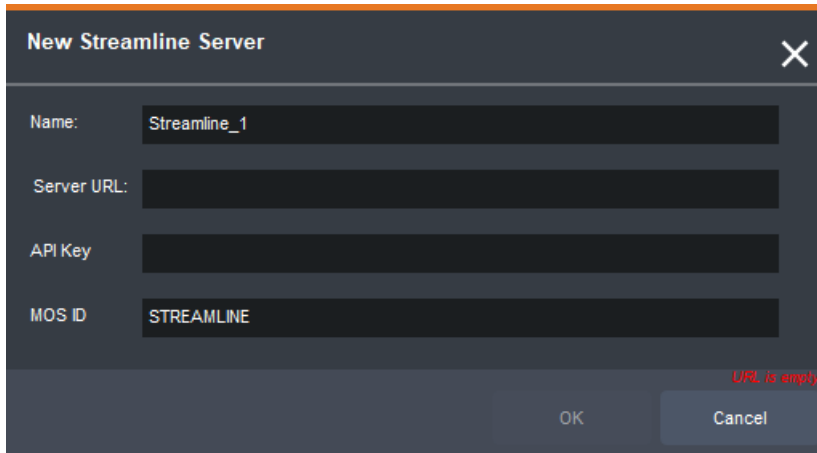

Add New Streamline Server

3. In the **New Streamline Server** window, enter a name for the server you are using.
4. In the **Server URL** field, enter the Streamline URL.
5. Enter the **Streamline API Key** provided by your administrator.

The MOS ID field is typically populated automatically based on the **MOS ID** set in the Streamline configuration. If the **MOS ID** in Streamline is changed, this field will need to be manually updated.

6. Then select **OK**.

To retrieve Streamline assets:

1. In the **Web** panel, enter the Streamline URL into the address bar and press **Enter**.
The Streamline login page opens.
2. Enter your login credentials to access Streamline.
3. In Streamline, select the **Assets** folder and browse to the asset you want to use.

4. Then drag and drop the asset into any of the following locations:

- a **Router** source slot
- the **Resource Path** in a **Router** event in the **Sequencer**
- an **Event** button (to be used as a thumbnail)

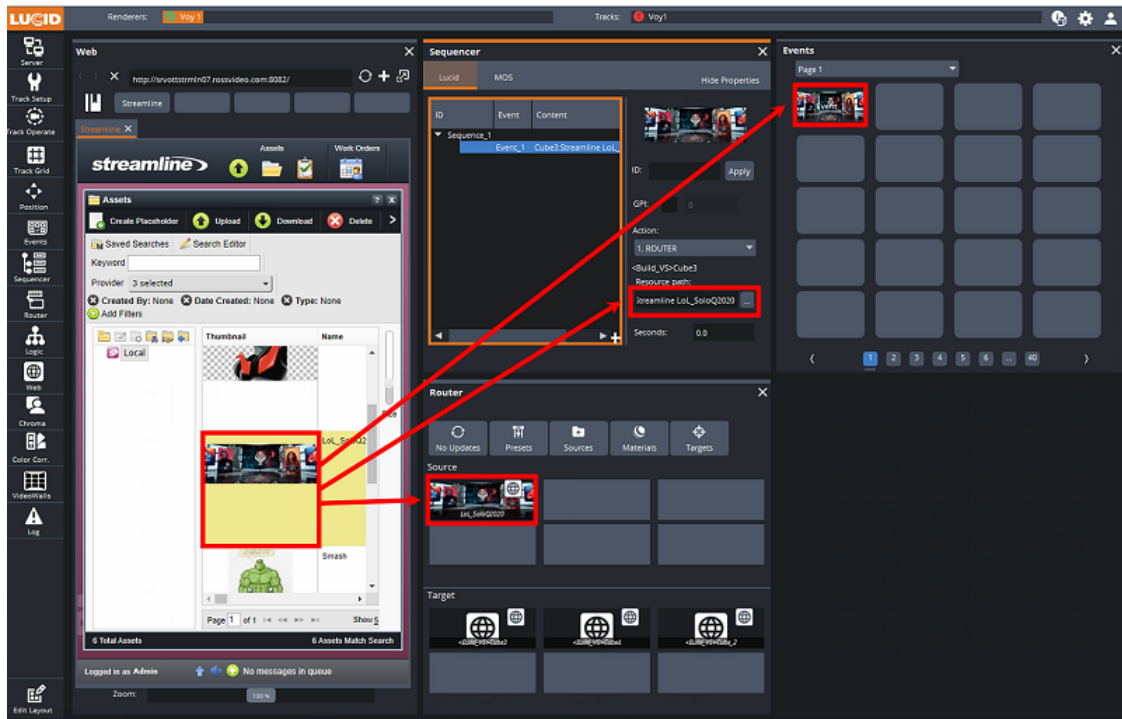

Streamline Integration

DataLinq

Use the DataLinq pane to configure how you will access your DataLinq sources. You will need to have the XPression DataLinq Server installed and running to access a DataLinq source.

To use DataLinq:

1. In the **Lucid Setup** window, select the **Ross** tab.
2. In the **DataLinq** pane, select the **+** icon in the bottom-right corner.

The **New DataLinq Source** dialog opens.

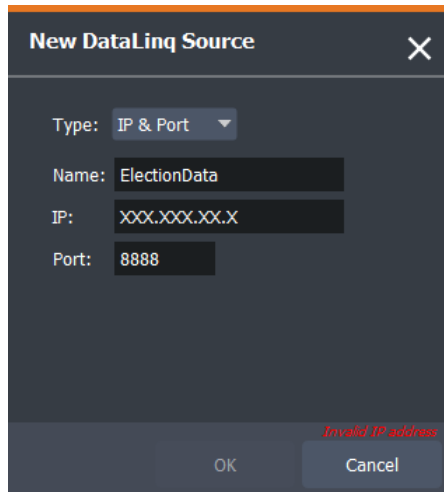

New DataLinq Source

3. From the **Type** drop-down, select one of the following connection types and see the corresponding section for further instructions:

IP & Port

EndPoint — only the first **IP** and **Port** of an **Endpoint** will work. Any additional **IPs** and **Ports** will be ignored. If you are configuring several DataLinq Servers, ensure that each server is connected to a different **Endpoint**.

IP & Port

1. If you selected **IP & Port**, in the **Name** field, enter the name of the DataLinq Source you want to use.
2. In the **IP** field, enter the IP address of the machine hosting the XPression DataLinq Server.
3. In the **Port** field, enter the number of the port on which Lucid will be communicating with the XPression DataLinq Server.
4. Select **OK**.

EndPoint

1. If you selected **Endpoint**, in the **Name** field, enter the name of the DataLinq Source you want to use.
2. In the **Endpoints** section, select the icon in the bottom-right corner of the pane.

The **Endpoints** window opens.

3. Refer to [Endpoints](#) for further instructions.

4. When you have finished configuring the **EndPoint(s)**, select **OK**.

WebAPI

Use the **WebAPI** tab to integrate with third parties, for getting events information and executing events (for instance to drive Lucid from StreamDeck). You can enable SSL for encrypted communication and generate an API Key that is required for authentication.

Using the WebAPI, you can execute events from a third party application or device, a web browser or from a [Stream Deck](#) control pad.

If you want to encrypt your communication with a third party application, you can choose to use your own security certificate or the included Lucid Certificate.

The WebAPI also enables mobile operation, using the QR code and its embedded Web UI.

WebAPI Information for Developers

The API is used by executing HTTP comands, passing the **API KEY**, and using HTTP or HTTPS according to the user API settings.

The API is now OpenAPI compliant and generates automatic Swagger documentation. The specifications can be accessed at <http://your IP address:9900/openapi>.

For further information on the API and SDK, select the **API Documentation** button (available only when the **API & Web Access** option is enabled).

Alternatively, with the **Web API** enabled, the documentation can be accessed using any web browser (example: <http://your IP address:9900/swagger>).

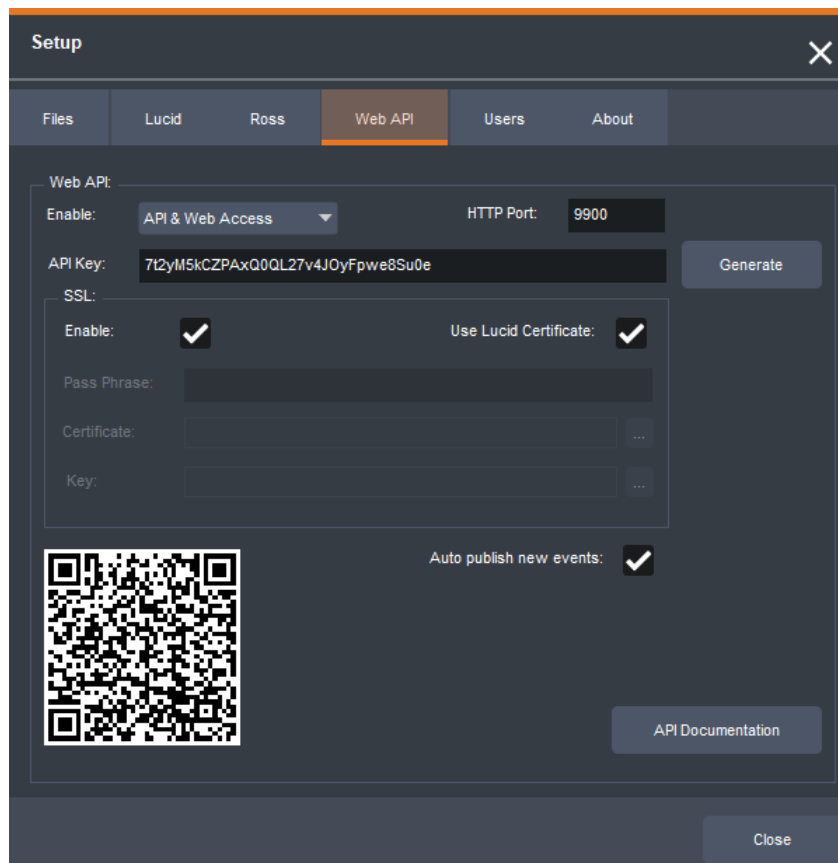

To select a WebAPI integration option:

1. In the **WebAPI** section of the tab, from the **Enable** drop-down, select one of the following options:
 - **Disabled** (no API or Web access)
 - **API & Web Access** (API Documentation button becomes active)
 - **Only API** (no Web access)
2. In the **HTTP Port**, enter the port number through which Lucid Studio will communicate with the third party.
The default port is **9900**.
An API Key is automatically generated.
3. If you want to change the **API Key**, select the **Generate** button or type a key (32 characters) in manually.

To enable encryption:

1. In the **SSL** section, select the **Enable** checkbox, if it is not already selected.
2. Select the **Use Lucid Certificate checkbox**.
OR
3. Clear the **Use Lucid Certificate** checkbox and enter the **Pass Phrase** for your own certificate, browse to and select your certificate and browse to and enter the key for your certificate.

To automatically publish new events to the Web API:

- Select the **Auto publish new events** checkbox.
All events currently set up in the **Events** panel and any new events will be published to the WebAPI.
If this checkbox is cleared, then any events currently being published to the WebAPI will continue to be published, but new events will not be published to the WebAPI.
Events can be manually set to be published in the **Events** panel in **Edit Events Published in Web API**.
See [Event Page Editing](#) for more information.

To enable mobile operation:

- Scan the **QR** code with your mobile device.

Stream Deck

The Lucid Plugin for Stream Deck allows you to play Lucid events from the customizable Stream Deck control pad, locally or remotely.

★ Install the Stream Deck application prior to running the Lucid Plugin for Stream Deck.

The following topics are described in this section:

[Installing the Lucid Plugin for Stream Deck](#)

[Adding Lucid Events to Stream Deck](#)

[Creating a Stream Deck Profile](#)

[Adding an Image to a Key](#)

[Editing Lucid Event Titles](#)

Installing the Lucid Plugin for Stream Deck

The Lucid Plugin for Stream Deck is included in the Lucid Studio installation file, but is deselected by default. Select the plugin during installation if you want to use it.

If you do not select the plugin when you first install Lucid Studio, you will need to go through the install process again, as described below.

To install the Lucid Plugin for Stream Deck:

1. Run the Lucid Studio install file (**Lucid_6.3.xxxx_x64.exe**) again.
2. When asked if you want to uninstall the currently installed version first, select **No**.
3. In the **License** screen, select **I accept the agreement** and then **Next**.
4. In the **Select Destination Location** screen, select **Next** to install in the same location as the already installed software.
5. In the **Confirmation** dialog, select **Yes**.
6. From the **Select Components** screen, select the **Lucid Plugin for Stream Deck checkbox** and select **Next**.

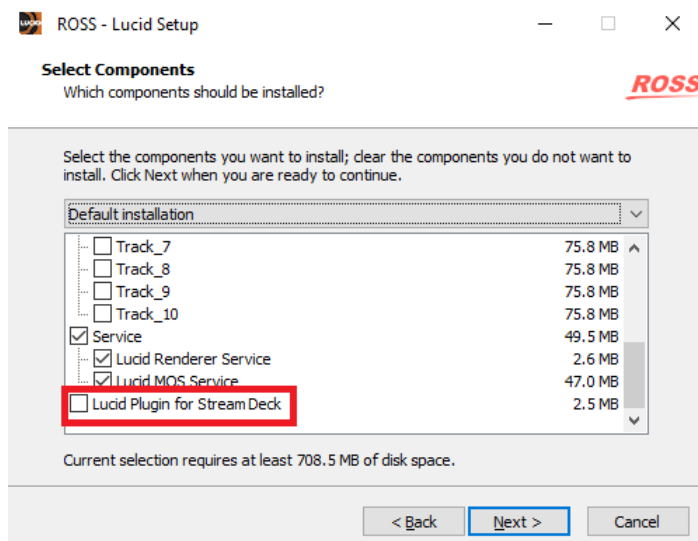

Select Lucid Plugin for Stream Deck

7. In the **Lucid** screen, select or deselect the **Start With Windows** option and select **Next**.

When the plugin has finished installing, a reminder dialog opens asking if you want to open the folder that contains the Lucid Plugin for Stream Deck.

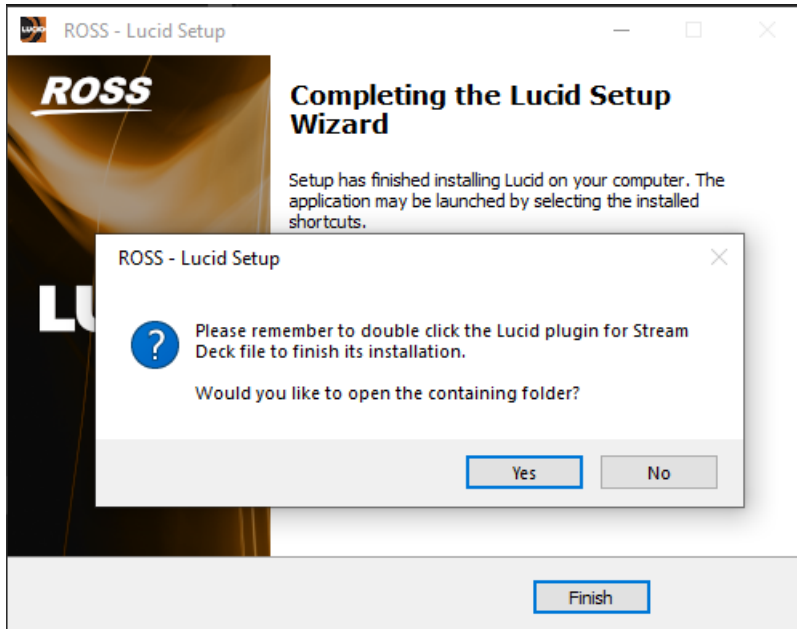

Lucid Plugin for Stream Deck - Reminder

8. Select **Yes** to open the folder.
9. Double-click the **com.rossvideo.lucid.streamDeckPlugin** file to install the Lucid Plugin into the Stream Deck application.
10. After installing the plugin, select **Finish** to close the setup wizard.

Adding Lucid Events to Stream Deck

Once you've installed the Stream Deck application and the Lucid Plugin for Stream Deck, you can launch Stream Deck and start adding your Lucid events to the Stream Deck keys.

To launch Stream Deck:

- If the application is not already running, type "Stream Deck" in the **Windows Search** field and then select **Open** to launch it.
- If the application is running, you'll see the Stream Deck icon  in the system tray.

To add Lucid events to Stream Deck:

1. Launch the Stream Deck application.
2. On the right side of the application window, scroll down to the **Ross Virtual Solutions** folder and drag a **Lucid Event** onto one of the blank Stream Deck keys.

3. Once a Lucid event is added to a key, you can select and drag any event from one key to another.

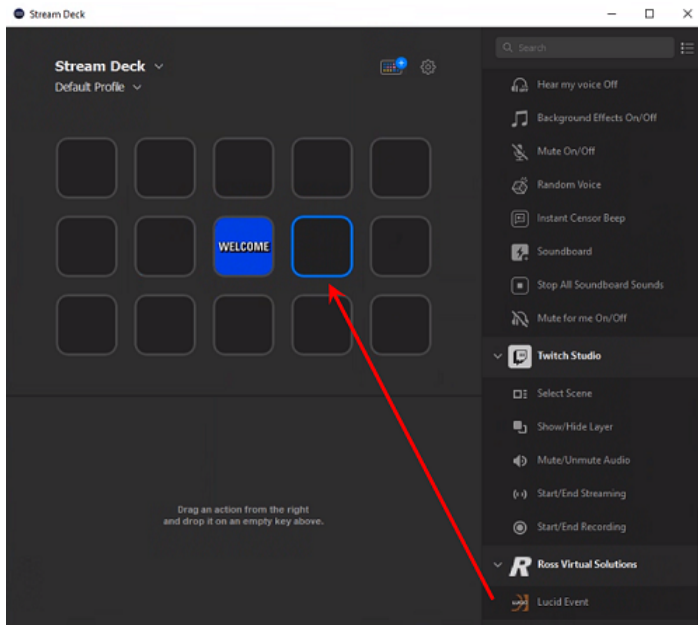

Stream Deck - Add Lucid Event

The Lucid Event details section is displayed.

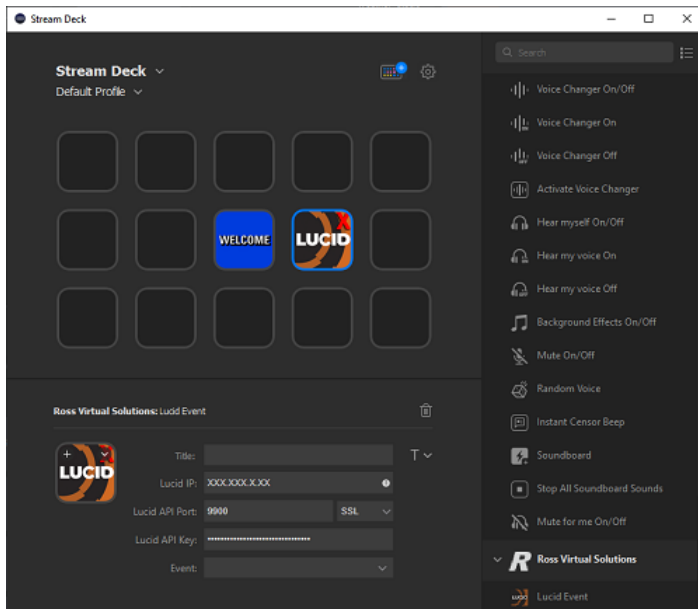

Stream Deck - Add Lucid Event Details

4. You can leave the **Title** field blank and it will be automatically populated by the title of the event you assign to the selected key from the **Event** drop-down.

OR

Enter any name you like.

5. In the **Lucid IP** field, enter the **IP** address of the Lucid machine.
6. Enter the **Lucid API Port** number, if the default port is different from the Lucid API's port setting.

7. From the drop-down beside the **Lucid API Port** field, select the security option you want to use, either **HTTP** or **SSL**.

The security option you select needs to match the security option set in the **Web API** tab of the Lucid Studio settings.

8. Copy and paste the **Lucid API** key from the **Web API** tab of the Lucid Studio settings into the **Lucid API Key** field and press **Enter**.

In the **Event** drop-down, you will see a list of the Lucid events created in the **Events** panel in Lucid Studio.

You'll also notice that the red **X** that was initially on the Lucid event key is now gone, indicating that the Stream Deck device is receiving the Lucid Event data.

9. From the **Event** drop-down, select an event to be activated by the new Stream Deck key.

The event text is displayed on the key. For information on adding an event image to the key, see [Adding an Image to a Key](#).

To delete a Lucid event:

- Select the event you want to delete and press the **Delete** button.
OR
- Right-click on the event you want to delete and select **Delete** from the menu.
OR
- Select the event you want to delete and select the trash can in the **Lucid Event** details.

To create subsequent event keys:

1. Copy and paste the first event key created onto a blank key.
The **Lucid IP** address, **Port** and **API Key** will be copied into the details of the new key.
2. With the new key selected, from the **Event** drop-down, select the event to be activated by the key.
3. Save a set of keys with a profile name (optional). See [Creating a Stream Deck Profile](#).

If you don't save your setup with a profile name, it will automatically be saved as the **Default Profile**.

Creating a Stream Deck Profile

In the Stream Deck application, you can set up a number of profiles, each with a unique combination of keys, make a specific profile your default and export your profile to a local folder.

To create a Stream Deck profile:

1. Create a set of keys to control your Lucid events.
2. From the **Default Profile** drop-down, select **Edit Profiles**.

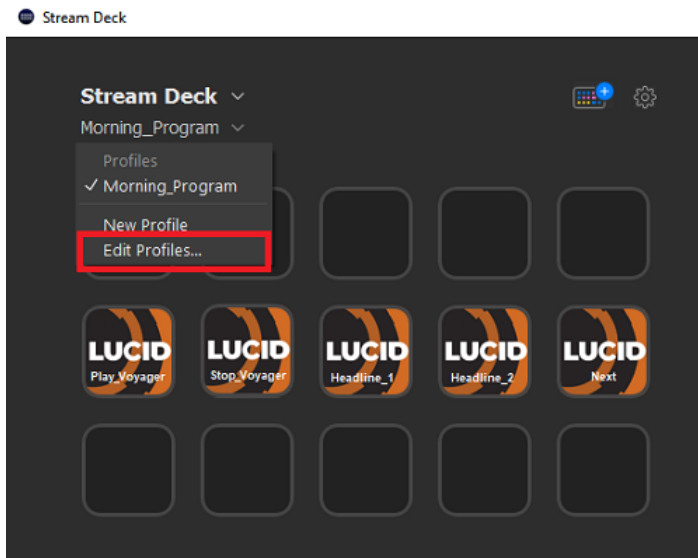

Stream Deck - Create New Profile

3. In the **Preferences** window that opens, in the **Profiles** tab, right-click **Default Profile** and from the menu options, select **Rename**.

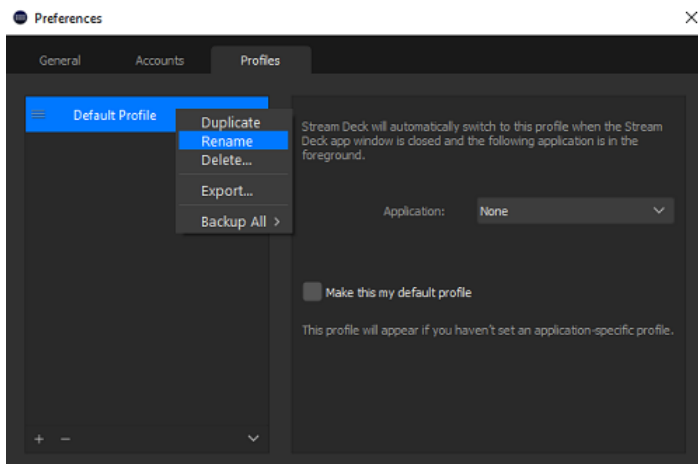

Stream Deck - Profile Preferences

4. Enter a name for the profile.
5. On the right side of the **Preferences** window, you can set the currently selected profile as your default profile (optional).
6. Right-click the **Profile** name again and select **Export** to save the profile to a local folder (optional).
7. Close the **Preferences** window.

Adding an Image to a Key

By default, Stream Deck will use the Lucid logo as the image for every key. You can change the image, if you want, to match the Event image in Lucid Studio or choose from a number of icons in the Stream Deck icon library.

To add a Lucid Event image to a key:

1. Select the key to which you want to add a Lucid **Event** image.
2. In the **Lucid Event** details section, select the down arrow in the Lucid icon.

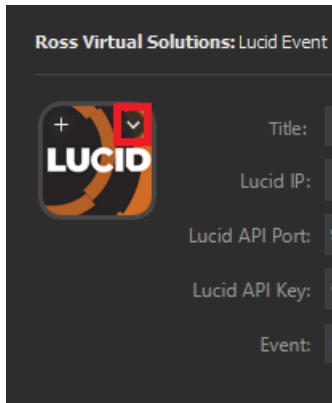

Stream Deck - Add Lucid Event Image

3. From the context menu, select **Set from File**.

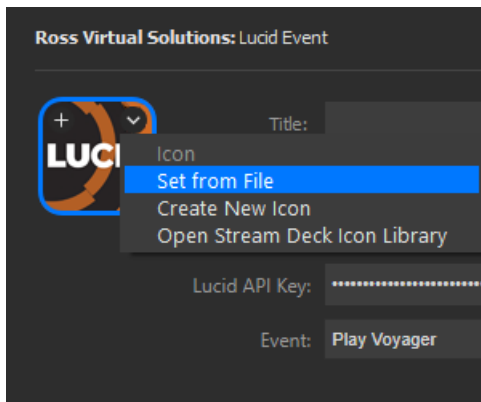

Stream Deck - Set from File

4. Navigate to the image you want to add to the key and select **Open**.
5. The new image appears on the key in the **Lucid Event** details section and on the selected key.

To add an icon from the Stream Deck Icon Library:

1. Select the key to which you want to add a Lucid **Event** image.
2. In the **Lucid Event** details section, select the **+** sign in the Lucid icon to open the **Stream Deck Icon Library**.

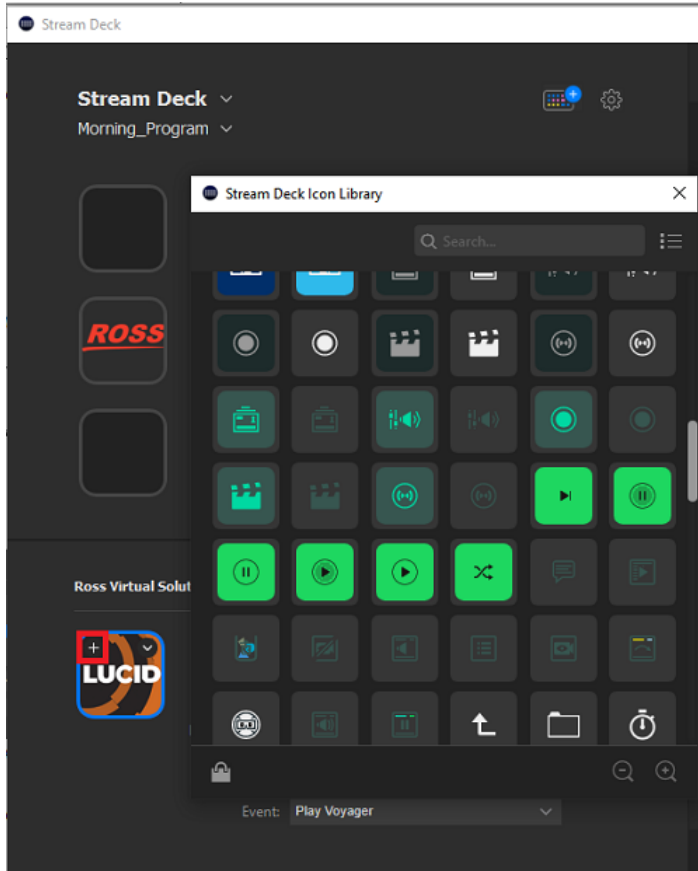

Stream Deck - Open Stream Deck Icon Library

3. Select an icon from the library.
4. The new image appears on the key in the **Lucid Event** details section and on the selected key.

Editing Lucid Event Titles

By default, Stream Deck will display the title that you used for your Lucid event. However, it uses a standard, white font. You can change this default title to make it larger or smaller, change the color of the title text so that it stands out better against the background, change the font or change where the title appears on the key. You can also make the title text bold, italic or underlined.

To edit Lucid event titles:

1. Select the key whose title you want to edit.
2. In the **Lucid Event** details section, beside the **Title** field, select the **Text** drop-down arrow.

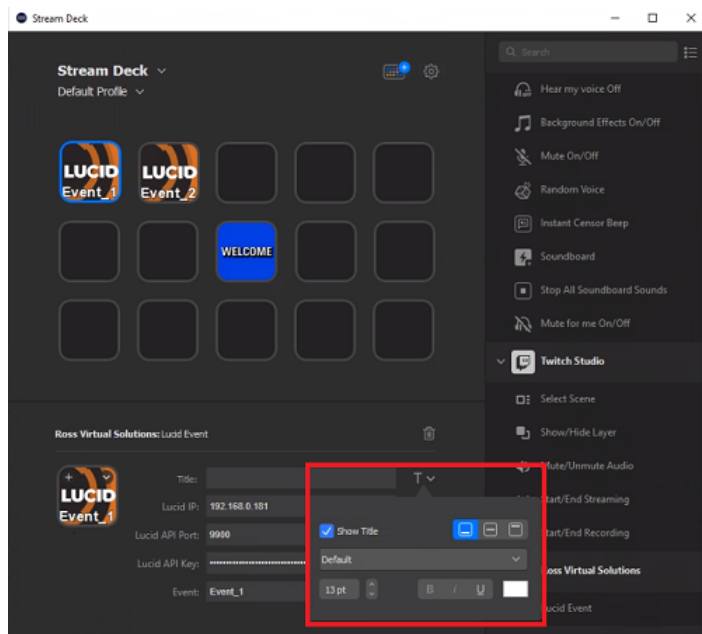

Stream Deck - Edit Event Title

3. Edit the title as follows:
 - Deselect the **Show Title** checkbox, if you don't want the title to be displayed.
 - Select where you want the title to appear, at the bottom, middle or top of the key.
 - From the drop-down, select the font.
 - In the **Size** field, enter a value or use the arrows to change the value to make the text bigger or smaller.
 - Select whether you want the text to be **Bold**, **Italic** or **Underlined**.
 - Select the white square to open a color picker and select a different color for the text.

Your changes are applied and saved automatically.

Users

In the **Users** tab, you can add and delete users, set/reset their user privilege and password and set a user to be the default user at startup. You can also upload a photo of the user. By default, the user profile is set to Admin.

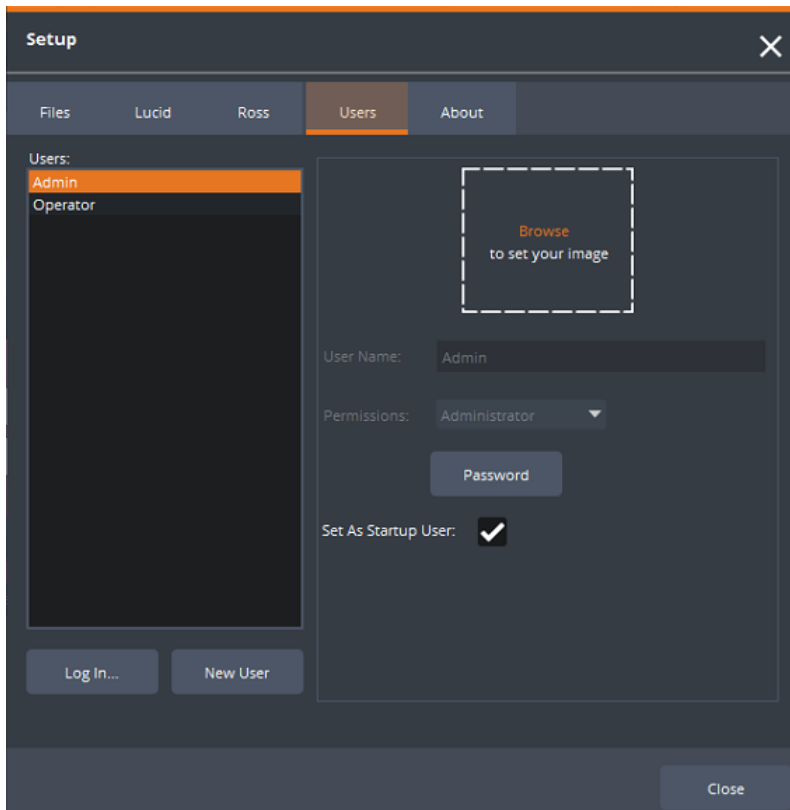

Lucid Studio Setup - Users Tab

To log in:

- From the **Users** list, double-click the name of the user you want to log in as.
- OR**
- Select the user name you are logging in as and select **Log in**.

To add a user:

1. Select the **New User** button.

The **New User** window opens.

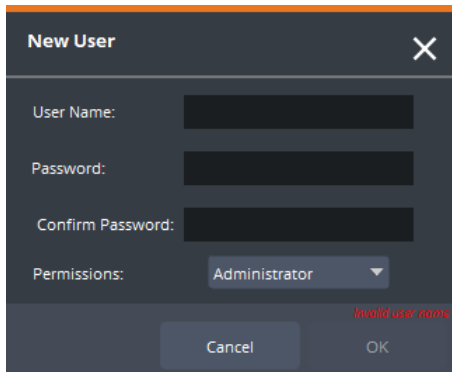

New User

2. In the **User Name** field, enter a name for the new user.
3. In the **Password** field, enter a password for that user.
4. In the **Confirm Password** field, re-enter the password.
5. From the **Permissions** drop-down, select the permission level you want to assign to the new user.
6. Then select **OK**.
7. Left-click inside the **Browse** to set your image frame, navigate to a photo of the user and select **Open** to add the photo.
8. Right-click to remove a photo.

To delete a user:

1. From the **Users** list, right-click the user you want to delete and select **Delete**.

The **Delete User** confirmation dialog opens.

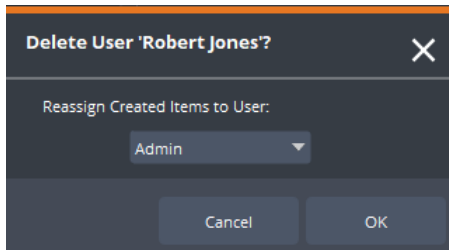

Delete User

2. From the drop-down, select the user to whom you want to reassign created items.
Reassigning created items gives control of anything that was created by the deleted user to the user you select.
3. Select **OK** to reassign created items and delete the user.

To change the user password:

1. Select the **Password** button.
The **Change Password** window opens.
2. Enter the current password in the **Old Password** field.
3. Then enter the new password in the **New Password** and **Confirm Password** fields.
4. Select **OK**.

Any user can change their own password. The default passwords are:

- **Admin:** ross
- **Operator:** operator
- **Other:** the name of the user, e.g., user1's password would be "user1", Bob's password would be "Bob"

5. As a standard security measure, change the default passwords when you begin using Lucid Studio.

To change permissions:

1. Select the user whose permissions you want to change.
2. From the **Permissions** drop-down, select one of the following permission levels to assign to that user.
 - **Administrator:** gives unrestricted access to adding, deleting and changing components in all panels, deleting or renaming users and changing their own password
 - **Operator:** restricts the user to operations-oriented functions
 - **Events-Only:** allows the user to execute only, not create
 - **Read-Only:** allows the user to read the UI but not make changes

To designate a user as the default user at startup:

1. Select the user you want to designate as the default user at startup.
2. Select the **Set As Startup User** checkbox.

In this way an **Admin** can make changes to Lucid Studio, close the application and the next time Lucid Studio is launched, the designated user will be automatically activated.

About

The **About** panel provides confirmation that the Lucid Studio license is valid. It allows users to see what version of Lucid Studio is installed and what specifically is included in the license and includes third party licenses. Normally, Lucid Studio is licensed with a USB dongle.

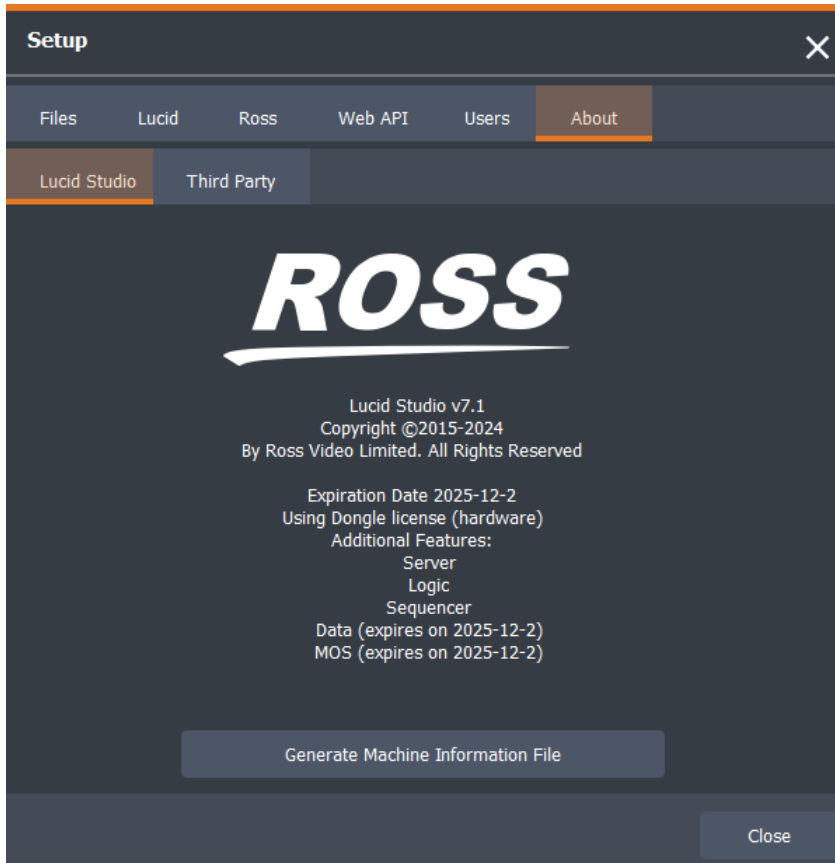

Lucid Studio Setup - About Tab

If your license is invalid, you can get a new one. This should only be necessary when a new system (computer, network card, disk drive) is being licensed (or relicensed) and you don't have a license dongle.

To get a new license, see:

[Contacting Technical Support](#)

Customizing and Managing Layouts

You can customize the layout, save and edit your layouts and create multiple layouts to suit your needs, as described in the following sections:

Customizing Layouts

Managing Layouts

Customizing Layouts

When you first launch Lucid Studio, it opens with as much of the default layout as fits on the screen. Thereafter, when you launch Lucid Studio, it will open with the last selected layout. Each panel occupies one or more cells, depending on its size. You can change the layout of the UI by adding or removing panels and resizing or rearranging panels.

To add a panel to the layout:

1. Select on a panel in the left-hand column and drag it into the layout where you want it.
2. As you drag the panel into the layout, a grid of cells is highlighted.

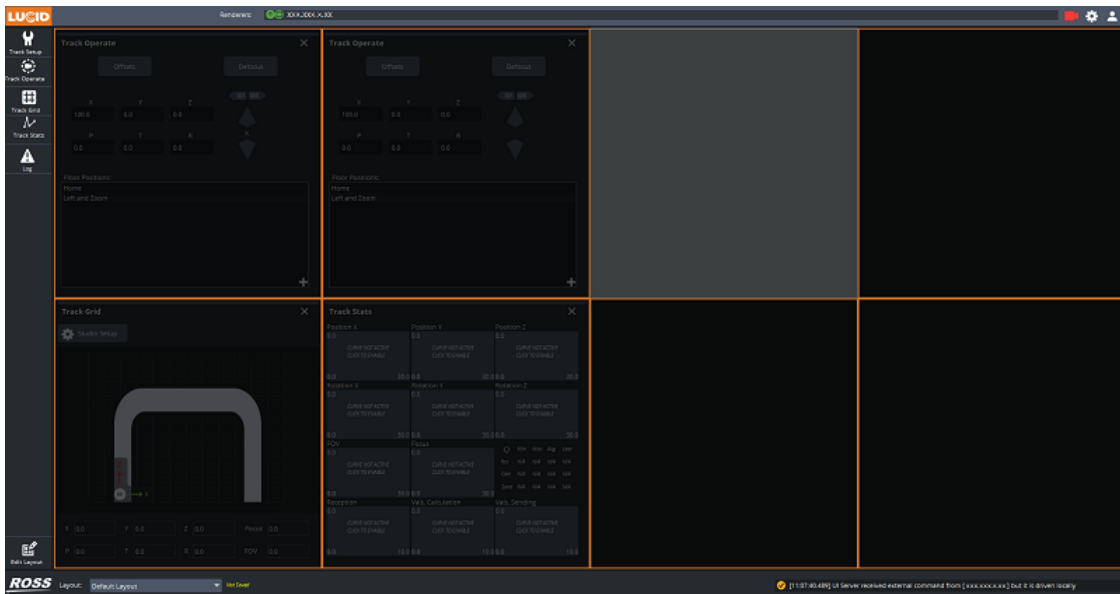

Edit Layout

3. Drag the panel into an empty cell.
If you drag the panel on top of another panel, the original panel will be removed.
4. Select the **Edit Layout** button again to return to the layout.

To remove a panel from the layout:

- Select the **X** in the top-right corner of the panel.

To resize a panel:

1. Select the **Edit Layout** button in the bottom-left corner of the UI.

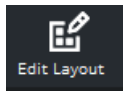

Edit Layout Button

A grid of cells is highlighted.

2. Select a corner square of the panel you want to re-size and drag it through the adjacent empty cell(s).

If there are no corner squares, it's because making that panel larger wouldn't provide any benefit.

A panel can take over any number of cells. If you drag it over a cell that already contains a panel, the original panel will be shifted right into an empty cell or if the new panel is taking over all the cells, the original panel(s) will be removed.

In the image below, the **Position** panel is taking up six cells.

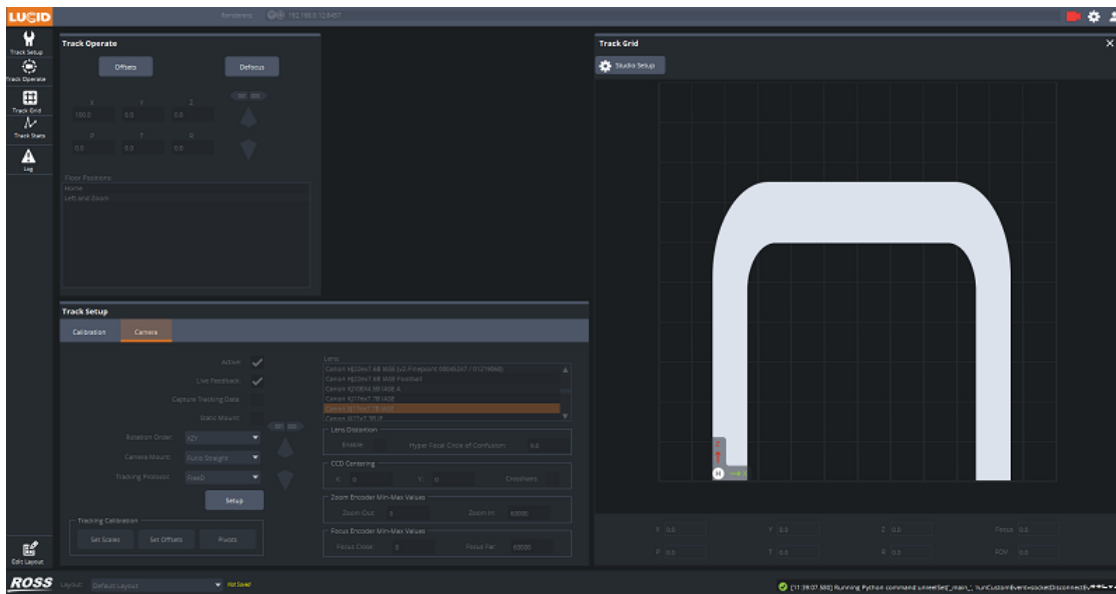

Resizing Panels

3. Select the **Edit Layout** button again to return to the layout.

To rearrange panels:

1. Select the **Edit Layout** button in the bottom-left corner of the UI.



Edit Layout Button

A grid of cells is highlighted.

2. Left-click the **Move** icon  in the center of the panel and while holding the mouse button down, drag the panel to a different cell and release the mouse button.
3. Select the **Edit Layout** button again to return to the layout.

Managing Layouts

Once you've customized your layout you can save it for future use and then edit it, when necessary. You can also

create multiple layouts. Save a layout anytime you make changes to it.

To save a layout:

1. From the **Layout** drop-down below the grid, select **Save Recent Changes** .
2. If this is the first time you are saving a layout, in the **Save Layout As** window, enter a name for the layout and select **OK**.

Thereafter, selecting **Save Recent Changes** will save the changes to the currently selected layout.

To select a saved layout:

- From the **Layout** drop-down below the grid, select the layout you want.

To discard changes to a layout:

- From the **Layout** drop-down below the grid, select **Discard Recent Changes**.

To edit a layout name or delete a layout:

1. From the **Layout** drop-down below the grid, select the layout you want to edit or delete.
2. Then from the drop-down, select **Edit Layout**.
3. In the **Edit Layout** window, enter a new name for the layout and select **OK**.

OR

Select the **Delete** button to remove the layout and in the confirmation dialog, select **OK**.

To add a new layout:

1. From the **Layout** drop-down below the grid, select **Save Layout As**.
2. In the **Save Layout As** window, enter a name for the layout and select **OK**.

Server

In the **Server** panel you connect Lucid Tracks to renderers, allowing the final camera data of any Lucid Track to be sent to any renderer.

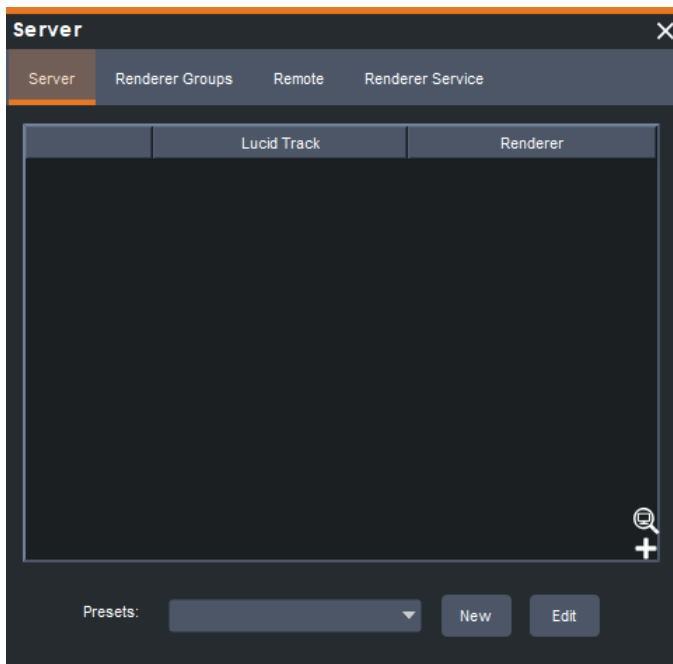

Server Panel

The **Server** panel also provides the following functionality:

- **Single point control:** you can manage several Lucid Tracks from one computer.
- **Single source** for multiple renderers: you can create groups of renderers and assign a group to one Lucid Track, so all of the renderers receive the same camera data.
- **Backup renderer:** you can have a spare renderer to which you can reroute the camera data.
- **Reassignment:** for example, if you have a Jib and 3 Furios, you can reroute the Jib data (from a Lucid Track) to one of the Furio renderers (you then have 2 Furios and 1 Jib).

The **Server** panel contains the following tabs:

[Server](#)

[Renderers Groups](#)

[Remote](#)

[Renderer Service](#)

Server

This tab allows you to add, edit and delete Lucid Tracks and renderers and assign them to one another. You can also save your Lucid Track/Renderer configurations as **Presets**, so that you can have several setups and be able to recall them as needed.

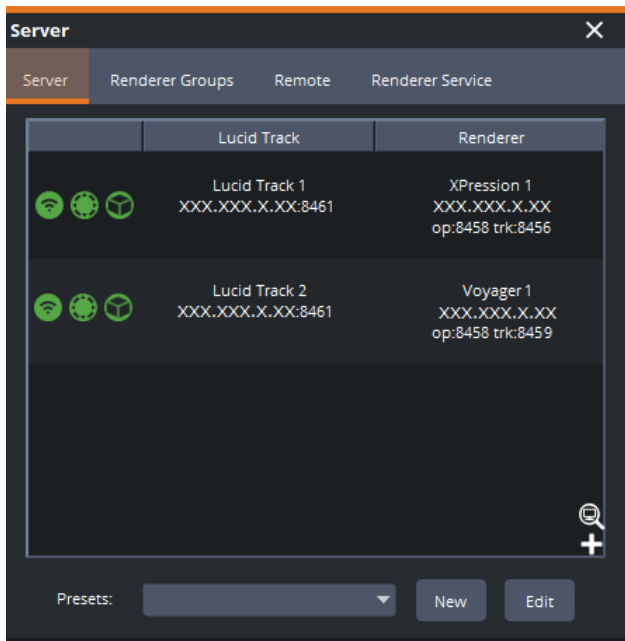

Lucid Tracks and Renderers

This section describes the following procedures:

[To add Lucid Tracks and Renderers using Auto-Discovery](#)

[To add a Lucid Track manually](#)

[To edit a Lucid Track](#)

[To delete a Lucid Track](#)

[To add a renderer manually](#)

[To edit a renderer](#)

[To delete a renderer](#)

[To assign a renderer to a Lucid Track](#)

[To add a server preset](#)

[To edit or delete a server preset](#)

To add Lucid Tracks and Renderers using Auto-Discovery:

1. If **Auto-Discovery** is selected in **Lucid Setup > Lucid > Auto-Discovery (SLP)**, select the magnifying glass icon in the bottom-right corner to open the **Add New Element from Network** window.

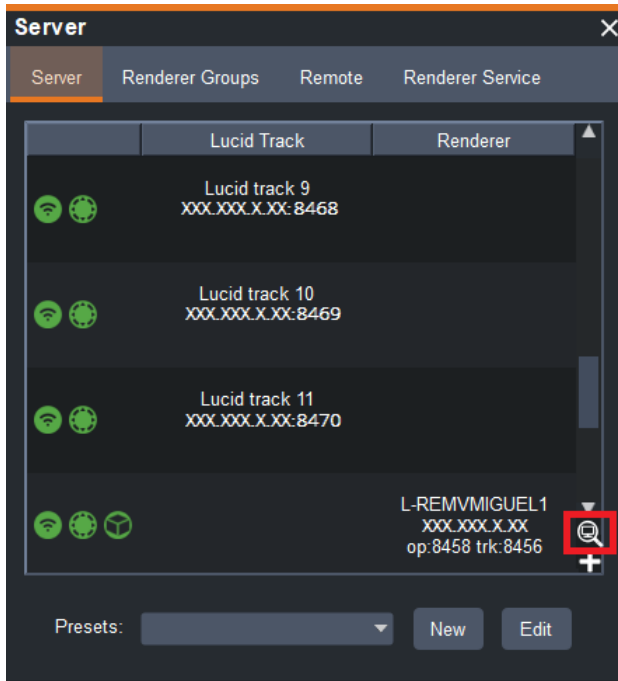

Auto-Discovery

The **Add New Element from Network** pane opens, displaying a list of the Lucid Tracks and renderers on the network.

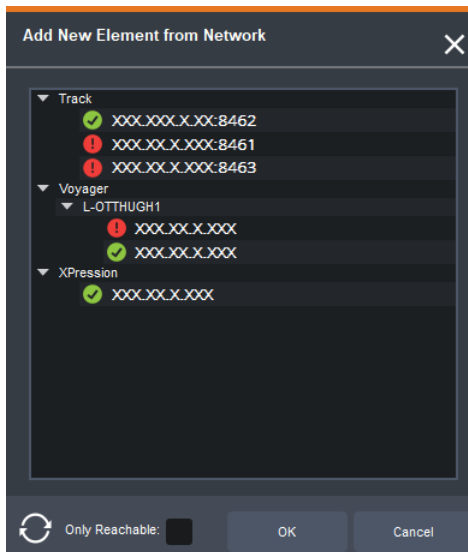

Add New Element from Network

- To display only those tracks and renderers that are reachable, select the **Only Reachable** checkbox. The results are filtered and the above window would look like this:

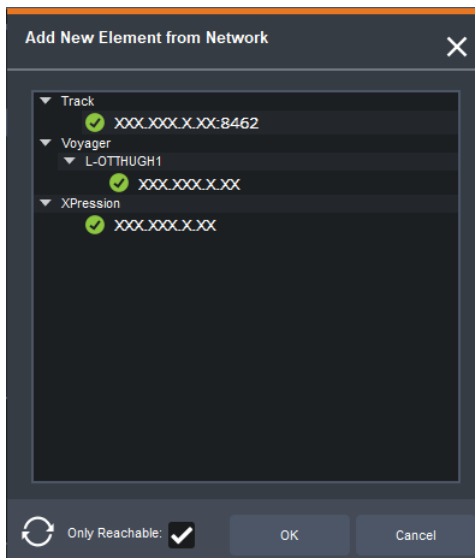

Add New Element from Network (Only Reachable Elements)

- Select the tracks and renderers you want to use and select **OK**.

To add a Lucid Track manually:

- Select the **+** icon in the bottom-right corner of the **Server** tab.
- In the **Add New Element** window that opens, select **Lucid Track** from the drop-down.

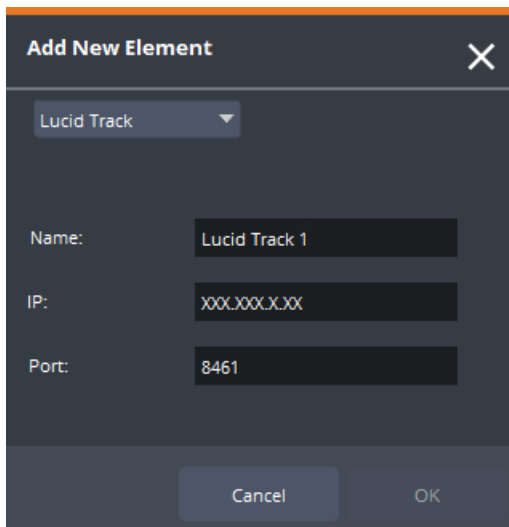

Add Lucid Track

3. In the **Name** field, enter a name to identify this instance of Lucid Track (eg. Lucid Track 1).
If using multiple Lucid Tracks, create names in numeric order.
4. In the **IP** field, enter the IP address of the machine hosting the Lucid Track.
5. In the **Port** field, enter the number of the Local Port set in the Lucid Track.
The default port is **8461**. If this port is in use already, then you can change it to an unused port, but it needs to match the port selected in the Lucid Track.
6. To verify what port number has been set in Lucid Track, select the **Lucid** tab from the **Lucid Track Setup** tool and check the **Local Port** number.
7. Select **OK** to save the Lucid Track.

To edit a Lucid Track:

1. In the **Server** tab, right-click the Lucid Track you want to edit.
2. Select **Properties**.
3. In the **Edit Element** window, edit the properties as needed.
4. Select **OK**.

To delete a Lucid Track:

1. In the **Server** tab, right-click the Lucid Track you want to delete.
2. Select **Delete**.
3. In the confirmation dialog that opens, select **OK**.

To add a renderer manually:

1. Select the **+** sign in the bottom-right corner of the **Server** tab.
2. In the **Add New Element** window that opens, select **Renderer** from the drop-down.

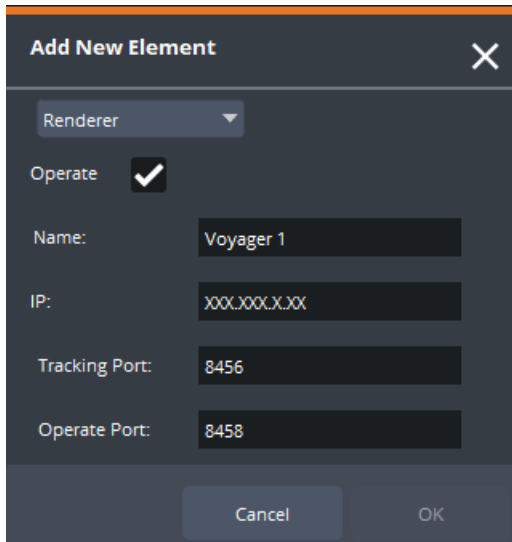

Add Renderer

3. Select the **Operate** checkbox to be able to make changes to the renderer from Lucid Studio or clear the checkbox if you are only using the tracking capabilities of Lucid Studio.
4. In the **Name** field, enter a name to identify the renderer.
If using multiple renderers, create names in numeric order.
5. In the **IP** field, enter the IP address of the machine hosting the renderer.
6. In the **Tracking Port** field, enter the corresponding port number used in the renderer.
For XPression, the corresponding port is the UDP Server Port set in Edit > Hardware Setup > Camera Tracking > Lucid Track.
For Voyager, the corresponding port is the UDP Port set in the Voyager Tracker editor.
The default Tracking Port is 8456.
7. If you selected the Operate checkbox, the Operate Port field is added. Enter the corresponding port from the renderer.
For XPression, the corresponding port is the TCP Port set in Lucid Driver for XPression > Settings.
For Voyager, the corresponding port is the communication port set in Lucid Configuration > Port.
The default **Operate Port** is **8458**.
8. Select **OK** to save the renderer.

To edit a renderer:

1. In the **Server** tab, right-click on the renderer you want to edit.
2. Select **Properties**.
3. In the **Edit Element** window, edit the properties as needed.
4. Select **OK**.

To delete a renderer:

1. In the **Server** tab, right-click on the renderer you want to delete.
2. Select **Delete**.
3. In the confirmation dialog that opens, select **OK**.

To assign a renderer to a Lucid Track:

1. Right-click on the table cell containing the renderer and select the **Assign To** option.

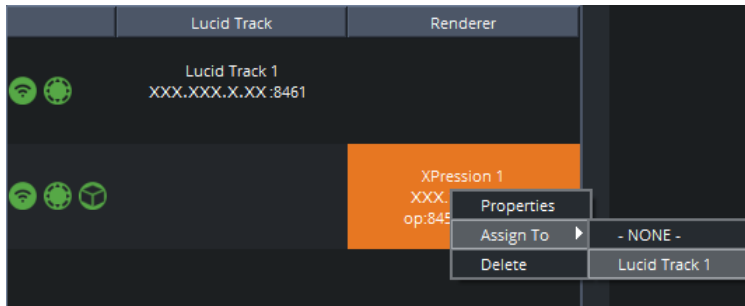

Assign Renderer

2. From the drop-down, select the Lucid Track to which you want to assign the renderer.

To add a server preset:

1. Once you've assigned your renderer(s) to a Lucid Track, select the **New** button beside the **Presets** drop-down.

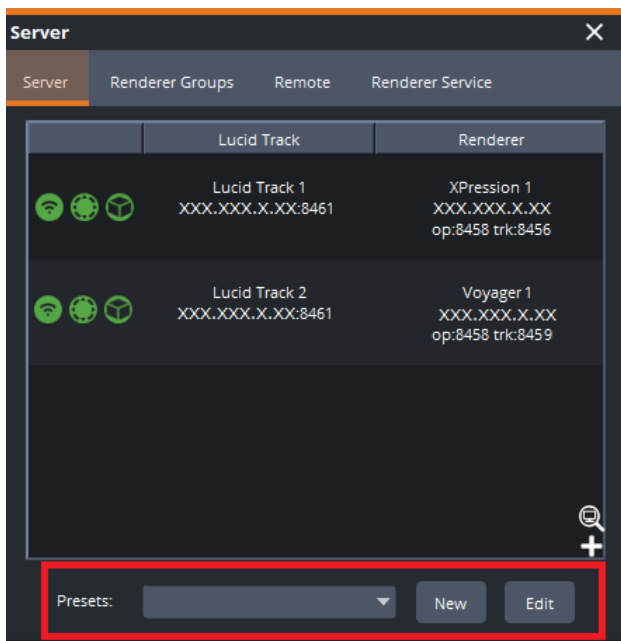

Lucid Studio Server Presets

The **New Server Preset** window opens.

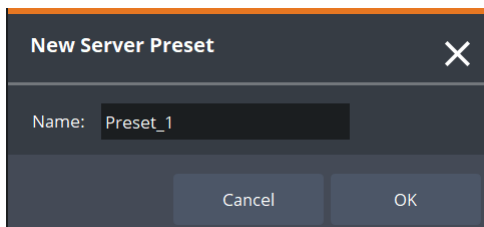

New Server Preset

2. Enter a name for the preset and select **OK**.

To edit or delete a server preset:

1. From the **Presets** drop-down, select the server preset you want to edit.
2. Select the **Edit** button to the right of the **Presets** drop-down.
3. Then do any of the following:
 - In the **Name** field, enter a new name the preset.
 - Select the **Use on Startup** checkbox to use the selected preset when Lucid Studio is launched.
 - Select the **Delete** button to delete the preset.

Status Icons

To the left of each Lucid Track instance and Renderer or Lucid Track/Renderer pair, you will see 2 or 3 status icons, representing:

• Network status

A green icon indicates that the Lucid Track and renderer are available on the network.

A red icon indicates that they are not.

An orange icon icon indicates that one or the other is not available.

• Tracking status

A green icon indicates that the Lucid Track is connected to the renderer and receiving tracking data from the camera and the renderer is receiving tracking data from Lucid Track.

An orange icon indicates that either Lucid Track or the renderer is not receiving tracking data.

A red icon indicates that neither Lucid Track or the renderer is receiving tracking data.

A yellow or half red and half green icon indicates that either Lucid Track is not connected or the renderer is not receiving tracking data.

• Renderer status

A green icon indicates that the **Operate Driver** is connected.

A red icon indicates that it is not.

Tip: When you hover your mouse over the icons, a tool tip describes the status.

Renderers Groups

The **Renderers Groups** tab allows you to create groups of renderers and assign available renderers to the groups. This enables one Lucid Track to send camera data to several renderers at once.

Once a renderer is part of a group, it can't be assigned individually to a Lucid Track. Only the group can be assigned to a Lucid Track.

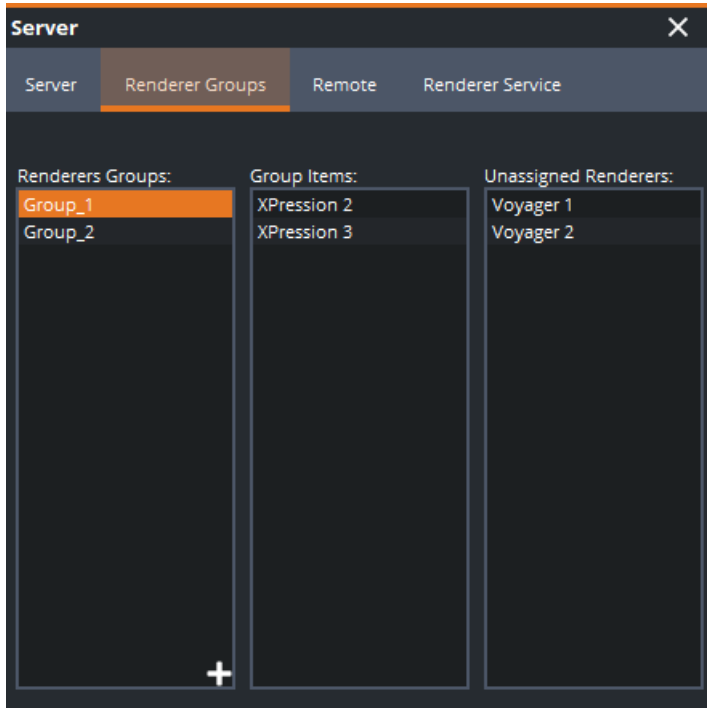

Server - Renderers Groups

This section describes the following procedures:

- To add a renderers group
- To edit a renderers group name
- To delete a renderers group
- To assign a renderer to a group
- To assign several renderers at a time to a group
- To view the renderers assigned to a group
- To delete a renderer from a group
- To assign a renderer group to a Lucid Track

To add a renderers group:

1. Select the **+** icon in the bottom-right corner of the **Renderers Group** pane.
2. In the **New Renderers Group** window, enter a name for the group and select **OK**.

To edit a renderers group name:

1. Right-click on the group name and select **Edit**.
2. In the **Edit Renderers Group** window, enter a new name for the group and select **OK**.

To delete a renderers group:

1. Right-click on a group name and select **Delete**.
2. In the confirmation dialog, select **OK**.

To assign a renderer to a group:

1. In the **Renderers Groups** pane, select the group name to which you want to assign renderers.
2. In the **Unassigned Renderers** pane, left-click on the renderer you want to add and drag it into the **Group Items** pane.

To assign several renderers at a time to a group:

1. In the **Renderers Groups** pane, select the group name to which you want to assign renderers.
2. Press and hold the **Shift** (or **Ctrl**) key and left-click on each renderer you want to add to the group.
3. Release the **Shift** (or **Ctrl**) key and then right-click and drag the selected renderers into the **Group Items** pane.

To view the renderers assigned to a group:

- In the **Renderers Groups** pane, select on the group name to see which renderers are assigned to it.

To delete a renderer from a group:

1. In the **Renderers Groups** pane, select on the group name from which you want to delete a renderer.
2. In the **Group Items** pane, left-click to select the renderer you want to delete.
3. Then right-click the renderer and select **Delete**.

The renderer is removed from the group and returned to the **Unassigned Renderers** pane.

To assign a renderer group to a Lucid Track:

1. Right-click on the table cell containing the Lucid Track and select the **Assign To** option.

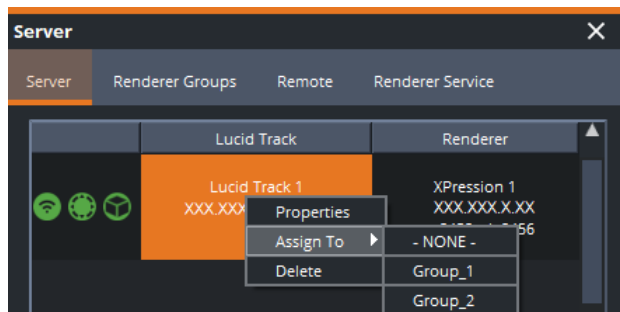

Assign Renderer Group

2. From the drop-down, select the renderer group you want to assign to the selected Lucid Track.

Remote

In the **Remote** tab you can add, edit and delete remote Lucid Studio servers.

The ability to connect several instances of Lucid Studio is not only for backup purposes, but also for flexibility of use and indication of availability. You can have multiple Lucid Tracks, renderers, and control rooms conducting multiple shows with Lucid Track and renderer awareness.

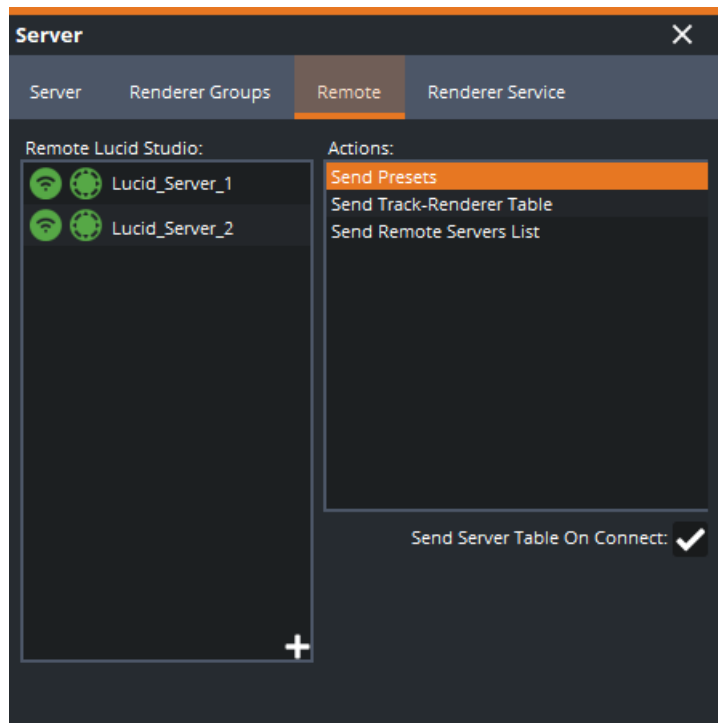

Remote Lucid Studio Servers

This section describes the following procedures:

[To add a remote Lucid Studio server:](#)

[To edit a remote Lucid Studio server:](#)

[To delete a remote Lucid Studio server:](#)

You can also execute the following actions:

- **Send presets:** sends the presets list of Lucid Track/Renderer pairs to the selected servers (easier commission if several servers have to be configured).
- **Send Track-Renderer table:** sends the current Lucid Track/Renderers table to the selected Lucid Studio servers.
- **Send Remote Servers List:** sends the list of remote servers to the selected Lucid Studio server.
- **Send Server Table on Connect:** when this checkbox is selected, the list of **Remote Lucid Studio servers** will be sent to the selected Lucid Studio server as soon as the connection is established.

To add a remote Lucid Studio server:

1. In the **Remote** tab, select the **+** icon in the bottom-right corner of the **Remote Lucid Studio** pane.
2. In the **New Remote Lucid Studio Server** window, enter a name for the server.
3. Enter the **IP** address and **Port** number of the machine running the remote Lucid Studio Server and select **OK**.

To edit a remote Lucid Studio server:

1. In the **Remote** tab, in the **Remote Lucid Studio** pane, right-click on the remote server you want to edit.
2. Select **Edit**.
3. In the **Edit Remote Lucid Studio Server** window, make the necessary changes and select **OK**.

To delete a remote Lucid Studio server:

1. In the **Remote** tab, in the **Remote Lucid Studio** pane, right-click on the remote server you want to delete.
2. Select **Delete**.
3. In the confirmation dialog that opens, select **OK**.

Status Icons

There are two icons to the left of each remote Lucid Studio Server in the Remote Lucid Studio pane.

- **Network status:** A green icon indicates that the Lucid Studio machine is available on the network. A red icon indicates that it is not.
- **Render status:** A green icon indicates that the renderer is connected. A red icon indicates that it is not.

Renderer Service

This tab allows Lucid Studio to load and run projects from multiple instances of the **RVS Engine Service**.

Tip: RVS Engine Service needs to be running on the Voyager or XPression machine in order for Lucid Studio to connect to it.

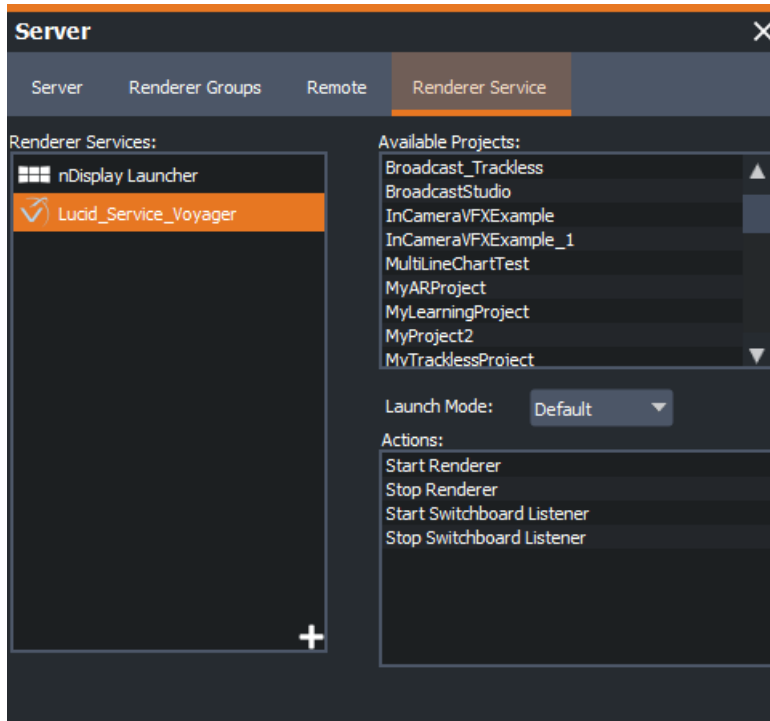

Renderer Service

This section describes the following procedures:

[Adding a Renderer Service](#)

[Editing a Renderer Service](#)

[Deleting a Renderer Service](#)

[Running or Changing a Project](#)

[Stopping a Project](#)

Starting Switchboard Listener

To add a Renderer Service:

1. Select the **+** icon in the bottom-right corner of the **Renderer Services** pane.
2. In the **New Lucid Service** window, enter a name for the renderer service.
3. Enter the **IP** address and **Port** number of the machine on which the **Renderer Service** is running.
The default port is **8911**.
4. Select **OK**.

To edit a Renderer Service:

1. In the **Renderer Services** pane, right-click the name of the service you want to edit.
2. Select **Edit**.
3. In the **Edit Lucid Service** window, make the necessary changes and select **OK**.

To delete a Renderer Service:

1. In the **Renderer Services** pane, right-click the name of the service you want to delete.
2. Select **Delete**.
3. In the confirmation dialog that opens, select **OK**.

To run or change a project:

1. Double-click the name of a Renderer Service.

The projects that are associated with that instance of **RVS Engine Service** are displayed in the **Available Projects** pane. Only the projects for one **RVS Engine Service** can be displayed at a time.

2. If this is a Voyager service, from the **Launch Mode** drop-down, select one of the following options:

Default — launch Voyager in the mode selected in RVS Engine Service.

Editor — launch Voyager in **Editor** mode (overwrites RVS Engine Service).

Game — launch Voyager in **Game** mode (overwrites RVS Engine Service).

★ If this is an XPression service, the **Launch Mode** drop-down does not appear.

3. Double-click a project to run or change to that project.

The **Loading Project** message is displayed and the new project is loaded to the renderer and begins to play. If another project was running previously, Lucid Studio will automatically stop that project before starting the new one.

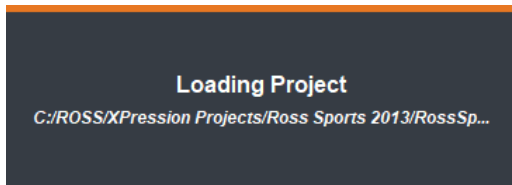

Loading Project Message

To stop a project:

1. In the **Available Projects** pane, select the project.
2. In the **Actions** pane, select **Stop Renderer**.

Track Setup

The **Track Setup** panel is used to configure the camera calibration, the camera parameters and the tracking calibration.

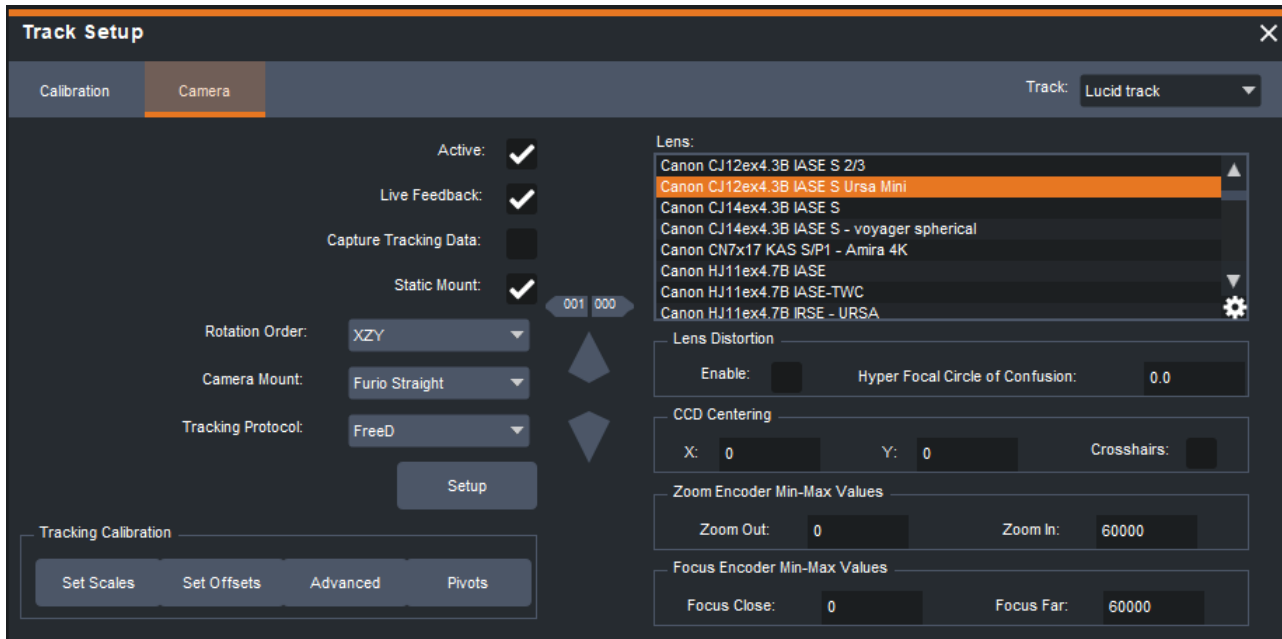

Track Setup Panel

The Track drop-down on the right allows you to select the Lucid Track you want to control. Any camera-specific configuration parameters or commands will be applied to the selected Lucid Track.

★ Lucid Track represents the real camera and the Renderer represents the virtual camera.

Tip: For any numeric editor in Lucid Studio, the mouse wheel will modify the digit where the mouse cursor is. For example, in the number 123.45, if the cursor is between 1 and 2, the number will change to 133.45, 143.45, etc as you scroll the mouse wheel up; or 113.45, 103.45 as you scroll the mouse wheel goes down.

This section covers the following topics:

[Calibration](#)

[Camera](#)

Calibration

The content of the **Calibration** tab varies depending on the camera mount selected in the **Camera** tab. At a minimum, it contains the three offset values of the camera relative to the three axes of rotation. In each case, the offset is the distance from the center of the camera's lens (at the point where the lens meets the camera body) to the rotational axis.

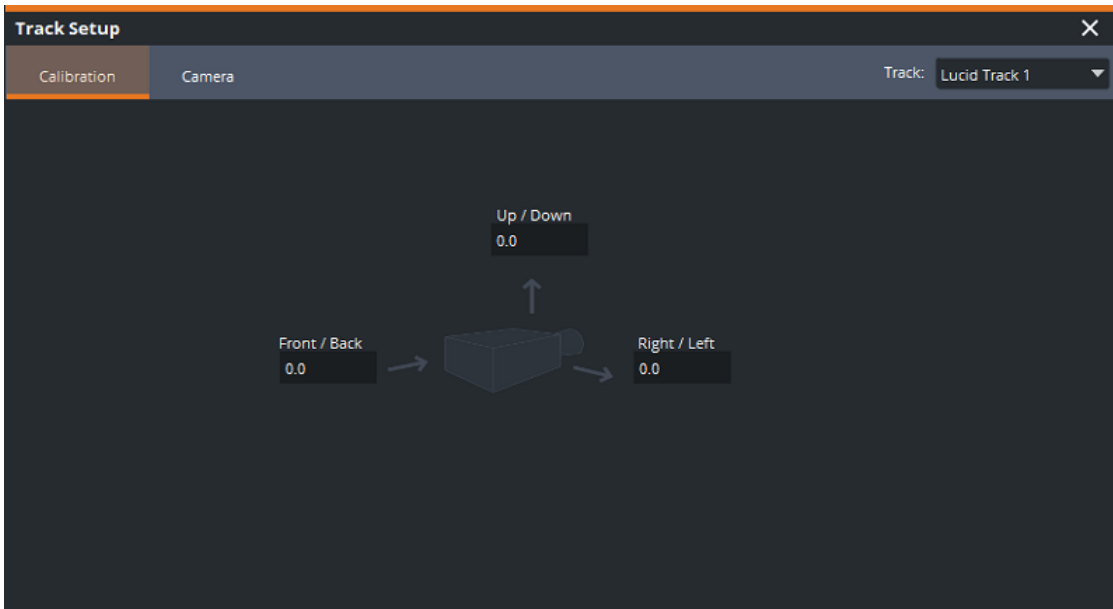

Calibration

The **Up/Down** offset is the vertical distance from the center of the lens to the horizontal axis on which the camera tilts.

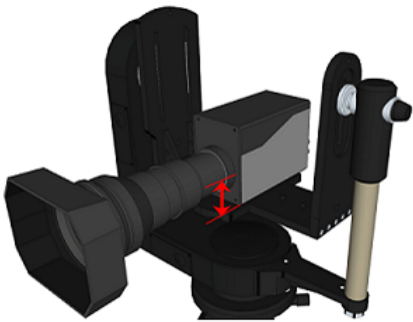

Up/Down Offset

The **Right/Left** offset is the horizontal distance from the center of the lens to the vertical axis around which the camera pans.



Right/Left Offset

The **Front/Back** offset is the horizontal distance forward or back from the point at which the pan and tilt axes intersect.



Front/Back Offset

In addition to these three basic offsets, there may be additional offsets required depending on the mount type (see description below). If, for example, the mount type is a jib, you will need to enter:

- the height of the main pivot
- the jib arm length
- the nose pivot up-down offset (relative to the arm)
- the nose length
- the tilt from pan-axis offset

The screen shows a graphic depiction of a the selected camera to indicate where these measurements are taken.

Camera

The **Camera** tab captures information about the camera's setup. The left side contains tracking parameters and the right side contains lens information.

After being updated by the scales, offsets and other calibration modifiers, the render-ready data is sent to a renderer which manipulates existing cameras in the virtual set.

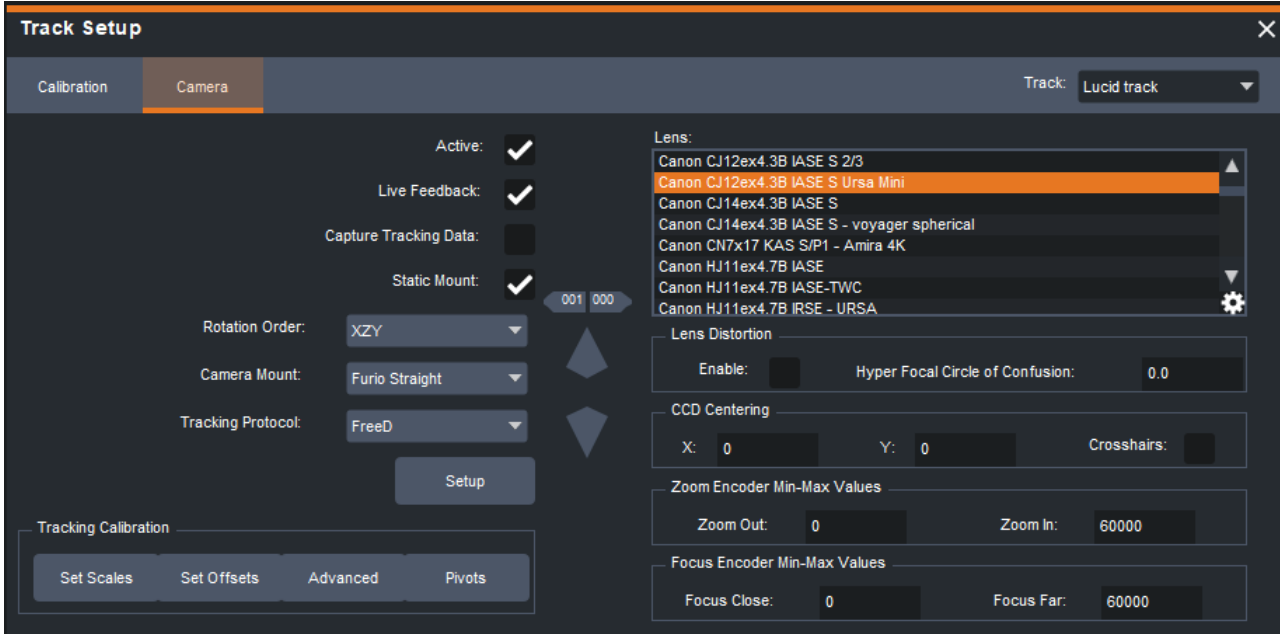

Camera

The **Camera** tab contains the following parameters:

[Tracking Parameters](#)

[Tracking Calibration](#)

[Lens Information](#)

Tracking Parameters

- **Active**

If this box is selected (default), the tracking for the selected camera is enabled. Clearing this box will cause the driver for the selected camera to stop accepting tracking data from the camera.

- **Live Feedback**

If this box is selected (default), the tracking data received by the driver for the selected camera will be continually sent to the UI for the operator to see. If this box is unchecked, the driver will continue receiving and processing tracking data, but will not send updates to the UI.

- **Capture Tracking Data**

Saves data to a file in the Track Log folder. By default, the file will be saved in **C:\ROSS\Lucid\ Lucid Track**.

To change the location of the track-logging folder:

1. Select the **Setup** button under the **Tracking Protocol** field.
2. Select the **Browse** button beside the **Track Log Folder** field.
3. Navigate to the location where you want to store the Track logs and select **Open**.

- **Static Mount**

When selected, this checkbox indicates that the camera is stationary. When cleared, it indicates that the camera is mounted on a moving tracking system and allows for positional data to be transmitted.

- **Rotation Order**

Selects the order of axis of rotation used for adjusting camera position. For example, **XZY** will apply the rotation in the X axis first, then the Z axis, then the Y axis. The default setting is **XZY**.

- **Camera Mount**

Selects what type of head and mount the selected camera is using. This is very important, as it may enable or disable certain axes, change tracking data scale values, etc.

- **Tracking protocol**

Specifies which protocol is being used for tracking telemetry data. Different heads or mounts may use different protocols, and some heads (e.g., Furio) can use more than one protocol. The tracking protocol that matches the selected camera mount is displayed by default. Make sure the protocol selected here matches what is being produced by the selected head and mount. More protocols can be added if required.

- **Setup**

Located under the **Tracking Protocol** drop-down, the **Setup** button opens a window that displays the values Lucid Track will send to the tracking parser in the renderers and configuration for the **Track Anomaly Filtering** on the left side. Not every parameter is supported by every protocol. The right side contains setup parameters specific to the selected protocol.

The **Tracking Data UDP Port** is the listening port for the selected protocol. This port must match the **Tracking** port of the renderer.

Some protocols will have more specific traffic handling parameters.

A few protocols (Trackmen, Stype and NCam) provide lens distortion data. In this case, you can select which lens distortion data you want to use, either the protocol specific data or the **Lucid Curves** data, from the **Lens Distortion** drop-down.

When using protocol-specific lens distortion, ensure that the **Lens Distortion** checkbox is selected in the **Values to Send to Renderers** section.

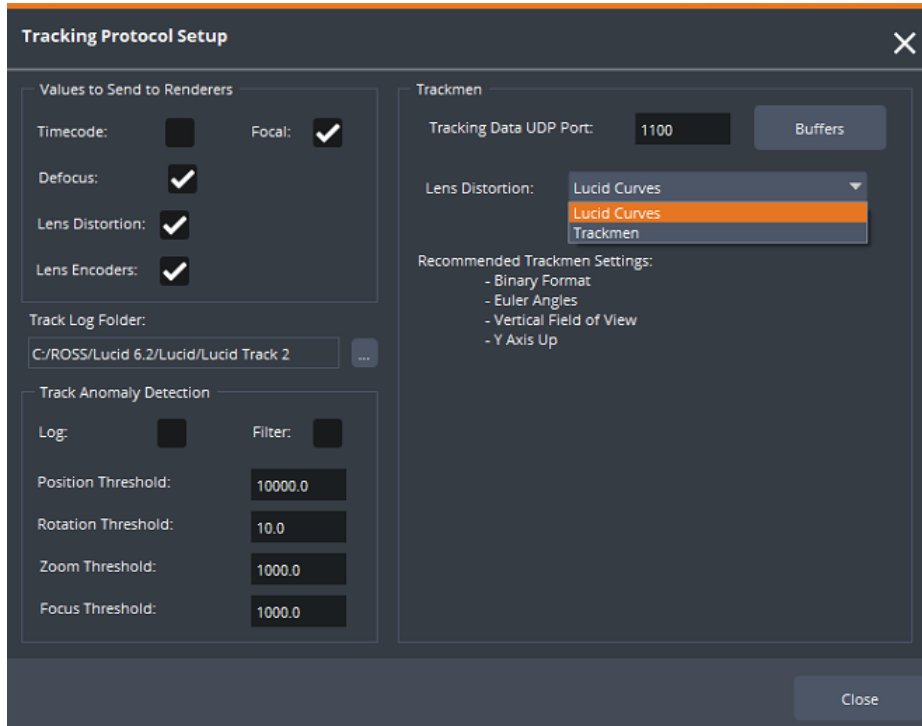

Tracking Protocol Setup - Trackmen

The **Buffers** parameter is common to all protocols. When you select **Buffers**, a window opens with positional data fields that allow you to manually adjust for delays. If you need to use this adjustment, match the delays to the slowest encoder.

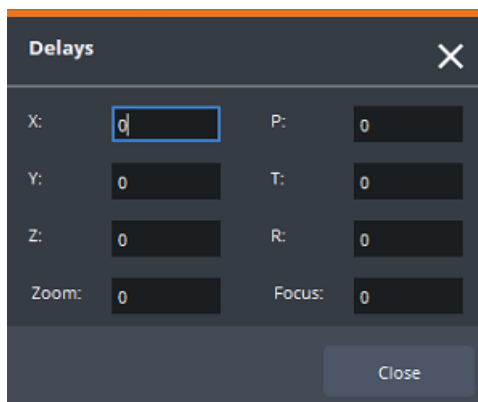

Buffers

Tracking Calibration

The [Set Scales](#) and [Set Offsets](#) buttons in this section set the global scales and offsets respectively. These global values are established as part of the calibration process.

The [Advanced](#) button opens a window where you can select the order in which the camera rotations should be applied for the final values calculation.

The [Pivots](#) button opens a read-only window with the **Pivots Values** displayed.

These global values establish the relationship between the real world of the physical studio and the 3D volume within which each of your cameras are being tracked. This is necessary, for example, to align disparate tracking technologies that may have different tracking-system-dictated origins. It could also be necessary to align multiple tracked cameras using the same tracking technology, but which are bound to different locations (e.g., a curved-track Furio system and a straight-track Furio system).

Set Scales

This button opens a pop-up window in which you can enter scale values for a number of calculated values. This is where, for example, the scale value is applied to translate from a Furio track system's encoder values to real-world units (e.g., inches or centimeters). You can also reverse direction of a given parameter. For example, to make tilt reverse its direction, enter a negative value in the **Tilt Scale** field. The fields in the pop-up are as follows:

- **Dolly**

Movement along a dolly track, if one is in use.

- **Swing**

For jib mounts, this refers to the jib-arm swing (Y-axis rotation).

- **Elevate**

For jib mounts, this refers to the jib-arm elevation (X-Axis rotation).

- **Extend**

If a telescopic jib is in use, this refers to the extension of the telescopic jib arm.

- **Pan**

This is the standard **Y** rotation movement.

- **Tilt**

This is the standard **X** rotation movement.

- **Roll**

This is the standard **Z** rotation movement.

- **X, Y, and Z Positions**

These are the standard location **X**, **Y** and **Z** coordinates in 3D space.

- **Zoom**

This refers to changes in lens zoom.

- **Focus**

This refers to changes in lens focus.

- **Value Change Control**

The **Value Change Control** determines the increment by which change is applied for each click of the **Up/Down** arrows.

To use it, select the input field whose value you want to change, select the desired scale value (i.e., how much change should occur for each click of an arrow button - ranging from **0.001** to **100**), and then select the up or down arrow to make the change.

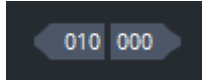

Value Change Control

- **Up/Down Arrows**

These arrows increase or decrease the selected value by the increment chosen in the **Value Change Control**.

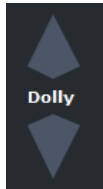

Up/Down Arrows - Tracking Scales

Set Offsets

This button opens a window in which you can enter offset values for the tracked 3D space relative to the global, or real world 3D space. This is particularly useful if you're using a track system that is not aligned along an axis in the physical space. If, for example, you had a Furio track that was at a 15-degree angle relative to the physical space, you could apply a 15-degree offset to the **Y Rotation** so that the track, in tracked space, is properly aligned along the X-axis. The fields in the pop-up are as follows:

- **X Position, Y Position, Z Position**

These are the standard location coordinates in 3D space.

- **X Rotation, Y Rotation, Z Rotation**

These are the standard rotation movements (**Tilt**, **Pan**, and **Roll** respectively).

- **Value Change Control**

The **Value Change Control** determines the increment by which change is applied for each click of the **Up/Down** arrows.

To use it, select the input field whose value you want to change, select the desired scale value (i.e., how much change should occur for each click of an arrow button - ranging from **0.001** to **100**), and then select the up or down arrows to make the change.

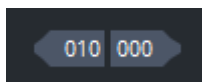

Value Change Control

- **Up/Down Arrows**

These arrows increase or decrease the selected value by the increment chosen in the **Value Change Control**.



Up/Down Arrows - Tracking Offsets

Advanced

This button opens the **Advanced Tracking Calibration Settings** window.

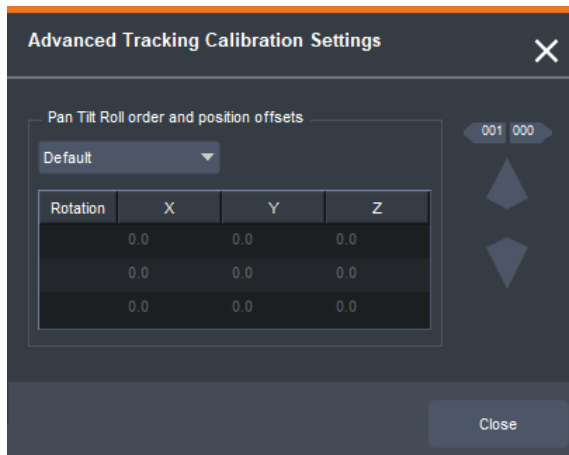

Advanced Tracking Calibration Settings

The table contains **X**, **Y**, **Z** values that are possible offsets to be used before applying the next rotation. You can select the order in which the offsets are applied.

For example, in the image below, an offset in the **Z** axis of the **Tilt** rotation will be applied after the **Pan** rotation and before the **Roll** rotation.

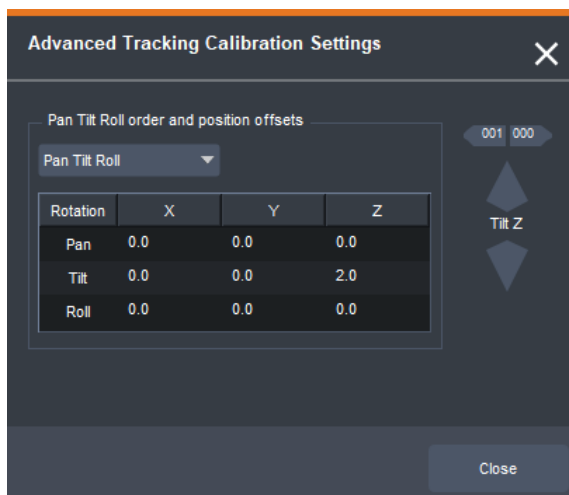

Advanced Tracking Calibration - Tilt Offset

To change the calibration mode and offsets:

1. From the **Rotation** drop-down, select the rotation order.
2. In the **Rotation** table, select the **X**, **Y**, or **Z** column of the camera motion you want to offset and enter the value of the offset.
3. Select **Close** to exit the window.

Pivots

This button opens the **Pivots Values** window.

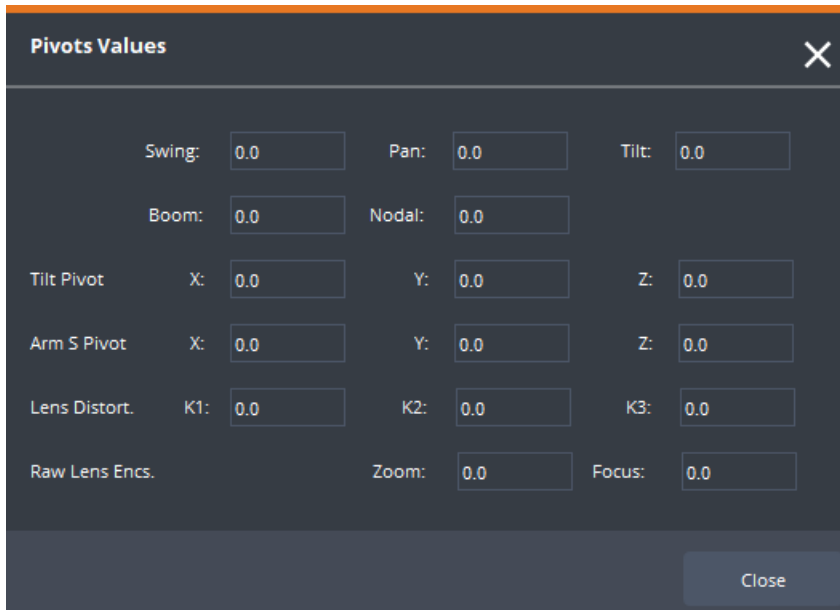

The screenshot shows a window titled "Pivots Values" with a close button (X) in the top right corner. The window contains several input fields for camera motion parameters, all currently set to 0.0:

Swing:	0.0	Pan:	0.0	Tilt:	0.0
Boom:	0.0	Nodal:	0.0		
Tilt Pivot	X: 0.0	Y: 0.0	Z: 0.0		
Arm S Pivot	X: 0.0	Y: 0.0	Z: 0.0		
Lens Distort.	K1: 0.0	K2: 0.0	K3: 0.0		
Raw Lens Encls.		Zoom: 0.0	Focus: 0.0		

A "Close" button is located at the bottom right of the window.

Pivot Values Window

Pivots Values Window

The read-only fields in this window provide additional detail regarding the camera-tracking data. The fields in this window are:

- **Swing, Boom**

For jib-mounts, these fields show the angle values (degrees) coming in for jib-arm swing (Y-axis rotation) and boom (X-axis rotation) respectively. The **Swing** value combined with the **Pan** value, results in the final camera pan angle. The **Boom** angle determines the height of the camera.

- **Pan, Tilt**

These fields show the angle values (degrees) for **Pan** and **Tilt** respectively, before any scaling or offsetting has been applied.

- **Nodal**

The calculated nodal offset from the lens curve.

- **Tilt Pivot X, Y, Z**

The **Tilt Pivot** represents the point of intersection between the **Pan Pivot** and the **Tilt Pivot**. These fields show the camera **X**, **Y**, and **Z** values before any camera offsets or any lens-curve positional shifts are applied.

- **Arm S Pivot X, Y, Z**

For jib mounts, this is the jib arm swing pivot - and represents the intersection of this swing pivot with the jib-arm boom pivot. The **X**, **Y**, and **Z** location of this intersection is typically directly above the jib's floor position - and allows you to confirm that the jib arm's starting height is correct.

- **Lens Distort. K1, K2, K3**

These are distortion coefficients used so the renderer can apply the lens distortion in the final image.

- **Raw Lens Encoders: Zoom, Focus**

These fields show the lens zoom and focus raw encoder values as they come from the lens, before any scaling or offsetting is applied.

Lens Information

• Lens

Selects the specific lens being used on the selected camera. An extensive matrix of data for each lens in the list has been compiled and stored in the Lucid Studio database. The right lens ensures accurate tracking data.

Hover your mouse over a lens to see a tooltip indicating if that lens contains **Distortion** or **Defocus** information.

You can also add paths to custom lens files if you have them and want to use them. If you choose this option, be sure to add the path or paths to both the Lucid Track where you want to use it and to Lucid Studio (if you're not using a standalone Lucid Track) using the same procedure. The path doesn't have to be the same but the lens file has to be added in both.

If any of the following conditions occur, you will see a warning message.

- Lucid Studio doesn't have one or more lenses that are present in Lucid Track.
- Lucid Track doesn't have one or more lenses that are present in Lucid Studio.
- Lucid Track and Lucid Studio have different versions of the same lens.

Your custom lens file needs to have the extension **.uxl** to be valid.

To use a custom lens file:

1. Select the cog wheel in the bottom-right corner of the **Lens** pane.

This opens the **Lenses Options** window.

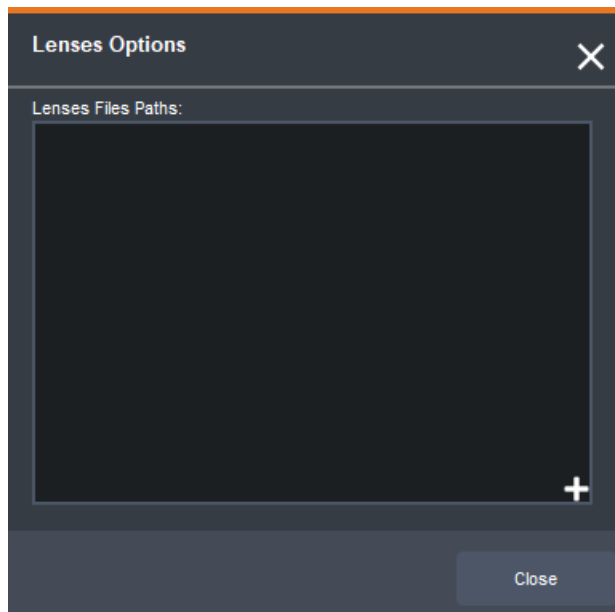

Lenses Options

2. Select the **+** icon in the bottom-right corner of the **Lenses Options** window.

3. In the **Select Folder** window, navigate to the location of your lens file and select **Select Folder**.

The path to your custom lens will appear in the **Lenses Options** window and also in the **Lens** list, from where you can then select it.

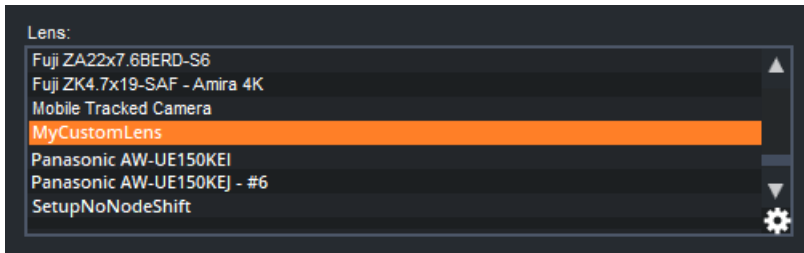

Custom Lens Added to Lens List

4. From the **Lens** list, select your custom lens.

The **Lens Changed** dialog opens, asking if you want to apply the default min/max values for **Zoom** and **Focus** encoders.

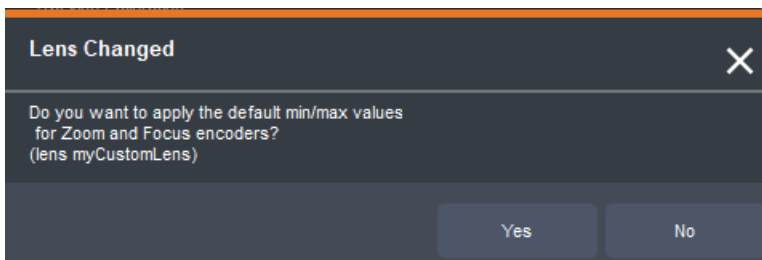

Lens Changed Confirmation

5. Select **Yes** to apply the default values for your custom lens.

- **Lens Distortion**

- **Enable**

- Enables lens distortion modeling. This feature can be critical for certain types of lenses or settings, but often is not necessary. Disabling it frees up graphics processor bandwidth for other uses. Default is **Disabled**.

- **Hyper Focal Circle of Confusion**

- This value is used for defocus calculations and is dependent on the image size. For 2/3" images, the value is 0.009.

- **CCD Centering**

- Each camera lens has a certain amount of offset from center based on its manufacture and how it is attached to the camera body. For tracking purposes, you need to determine how far it is offset in the X and Y directions from center on the charge-coupled device (CCD sensor) inside the camera.

- **X and Y**

- These values are determined using the CCD-Centering process. Once these values are determined, they are entered in their respective fields here.

- **Crosshairs**

- This checkbox enables or disables visual crosshairs on the renderer associated with the selected camera. These crosshairs are used in the CCD-Centering process.

- **Zoom Encoder Min-Max Values**

- These two fields are used to enter the minimum and maximum encoder values produced by the

encoded lens on the selected camera. The default values are 0 and 60,000 respectively (Canon) or 0 and 65,530 (Fuji), but these values should be replaced with actual values observed from the lens when it is at the extremes of its zoom range.

These values can be seen in the **Pivot** window.

- **Focus Encoder Min-Max Values**

These two fields are used to enter the minimum and maximum encoder values produced by the encoded lens on the selected camera. The default values are 0 and 60,000 respectively (Canon) or 0 and 65,530 (Fuji), but these values should be replaced with actual values observed from the lens when it is at the extremes of its focus range.

These values can be seen in the **Pivot** window.

- **Value Change Control**

The **Value Change Control** determines the increment by which change is applied for each click of the **Up/Down** arrows.

To use it, select the input field whose value you want to change, select the desired scale value (i.e., how much change should occur for each click of an arrow button - ranging from **0.001** to **100**), and then select the up or down arrow to make the change.

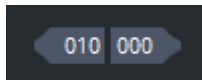

Value Change Control

- **Up/Down Arrows**

These arrows increase or decrease the selected value by the increment chosen in the **Value Change Control**.

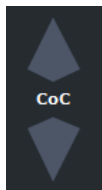

Up/Down Arrows - Lens Information

Track Operate

In the **Track Operate** panel, you can create and apply garbage mattes, adjust the camera offsets and defocus parameters and create and store floor positions. The **Track** drop-down allows you to select the instance of Lucid Track you wish to control. Any camera-specific configuration parameters or commands will be applied to the selected Lucid Track.

★ Lucid Track represents the real camera and the Renderer represents the virtual camera.

Tip: For any numeric editor in Lucid Studio, the mouse wheel will modify the digit where the mouse cursor is. For example, in the number 123.45, if the cursor is between 1 and 2, the number will change to 133.45, 143.45, etc as you scroll the mouse wheel up; or 113.45, 103.45 as you scroll the mouse wheel down.

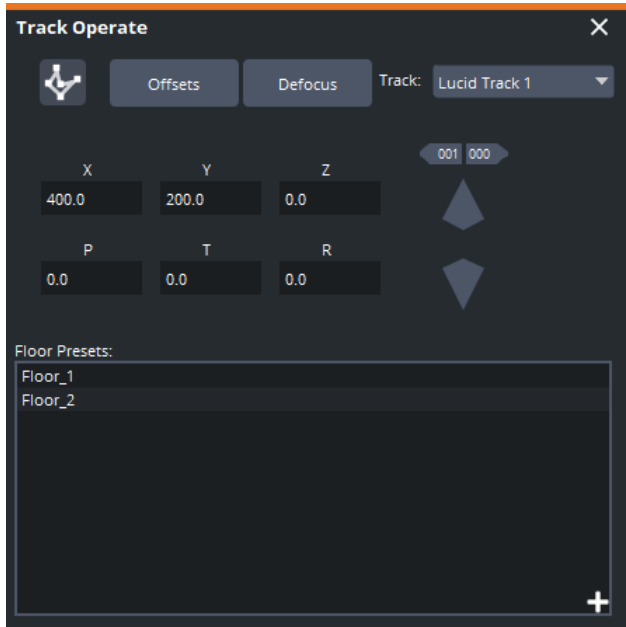

Track Operate Panel

This section describes the following features:

- [Garbage Mattes](#)
- [Offsets](#)
- [Defocus](#)
- [Floor Presets](#)

Garbage Mattes

In the **Garbage Mattes** pane, you can define and position virtual walls. Garbage mattes are typically used to extend the virtual set beyond the limits of the cyclorama. A garbage matte is typically a transparent rectangular plane that, when turned on, is put in the foreground (with respect to the chromakeyer), obscuring any physical objects that might be seen by the camera and ensuring that, in the area of the garbage matte, only the computer-generated scene is visible.

To see a visual representation of the garbage mattes you are creating, add the **Track Grid** panel to the layout, if it's not already there.

Only administrators and operators can manage garbage mattes. Both can save garbage matte positions to presets and play those presets. An administrator can edit and delete any garbage mattes. An operator can only edit and delete garbage mattes they've created themselves.

Selecting the  icon opens and closes the **Garbage Mattes** pane.

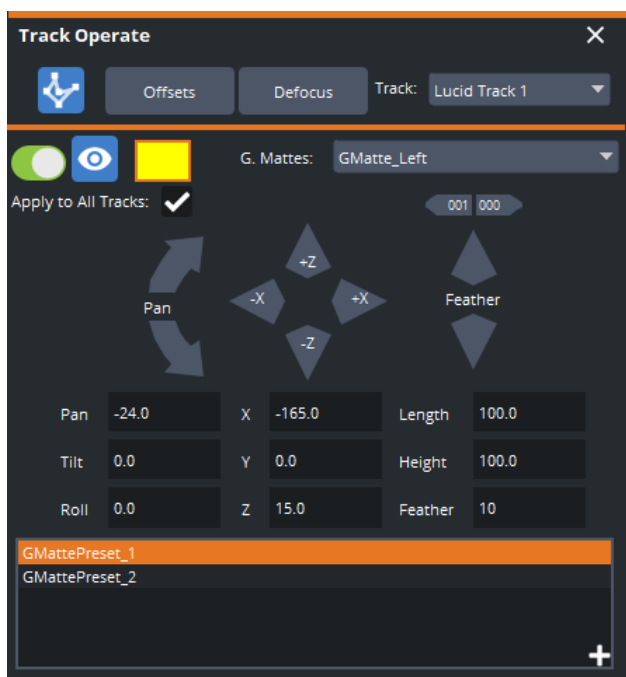

Garbage Mattes

Icons

There are three icons in the top-left corner of the pane, as described below:

- **Enable/Disable Garbage Mattes** 

This icon toggles on selection. It will be green when the selected garbage matte is enabled in the scene and gray when the selected garbage matte is disabled.

If a garbage matte is disabled and hidden, it will have no impact on the rendered scene.

- **Show/Hide Selected Garbage Matte** 

This icon toggles on selection. A gray icon indicates that the garbage matte is hidden and a blue icon indicates that the garbage matte is visible.

Garbage mattes can be made visible to assist in positioning them within the scene. After you have the mattes properly positioned for a given production, turn off visibility.

- **Color** 

The color icon brings up a standard color selector, so you can show each matte in a unique solid color in the renderer, when **Show Selected Garbage Matte** is selected.

Apply to All Tracks

This checkbox (unchecked by default) indicates that the configured garbage mattes should be used for all cameras/renderers in the Lucid Studio production. If, for example, the Left garbage matte is placed three feet to the left of the anchor's desk in 3D space, then each renderer will have the Left matte in that same position. This is the most common way to run a virtual production.

If you want these mattes to be in different positions for different cameras, unchecking this box will cause Lucid Studio to create "**N**" sets of garbage mattes, where "**N**" is the number of cameras. In this case, selecting a different active camera (from the **Track** drop-down list in Lucid Studio), will load the garbage mattes for the selected camera, complete with their own separate position and rotation data.

G. Mattes

From the **G.Mattes** drop-down, you can add and edit garbage mattes. To see a visual representation of the garbage matte you are creating, add the **Track Grid** panel to the layout, if it's not already there.

To add a garbage matte:

1. From the **G. Mattes** drop-down, select **New Garbage Matte**.
2. In the **New Garbage Matte** window, enter a name for the garbage matte and select **OK**.
3. Select the **Apply to All Tracks** checkbox to use the same garbage matte for all tracks or leave it blank to only use the garbage matte for the current track.
4. Use the [Garbage Matte Control Block](#) and/or the [Garbage Matte Data Fields](#) to position the matte.
5. Then select the **Show/Hide Selected Garbage Matte** (icon will be gray) so that the matte will not be visible in the rendered output.

Garbage Matte Control Block

Below the **Apply to All Tracks** checkbox is a standard set of position/rotation/length/height/feather controls used to configure the garbage matte:

- **Two curved arrows for changing rotation values**

These arrows control garbage matte rotation. They will affect the visual representation of the currently selected garbage matte, and will change values in the selected rotation field (**Pan**, **Tilt**, or **Roll**), with **Pan** being the default.

- **Four arrows in a star formation for changing position values**

By default, the left and right arrows within this star control movement along the X-axis. Selecting these arrows affects the value shown in the **X Position** field.

The up and down arrows in the star move the garbage matte along the Y-axis (vertically relative to the floor), or the Z-axis (forward and back along the floor) depending on whether the **Y Position** field or **Z Position** field is selected.

- **Up/Down Arrows**

These arrows increase or decrease the **Length**, **Height** and **Feather** value of the garbage matte by the increment chosen in the **Value Change Control**.

Value Change Control

The **Value Change Control** determines the increment by which change is applied for each click of the arrows.

To use it, select the input field whose value you want to change, select the desired increment (i.e., how much change should occur for each click of an arrow button - ranging from 0.001 to 100), and then click on the up or down arrows to make the change.

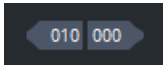

Value Change Control

Garbage Matte Data Fields

Below the **Control Block** is an array of data fields arranged in three vertical columns for rotation, position, and size/effect respectively: These values change as you click in the **Garbage Matte Control Block**. You can also enter values directly in the data fields.

- **Pan, Tilt, Roll**

Values that control the rotation of the selected garbage matte.

- **X Position, Y Position, Z Position**

Values that control the position in 3D space of the selected garbage matte.

- **Length, Height**

Values that control the size of the selected garbage matte. As garbage mattes are flat planes, they only have two dimensions.

- **Feather**

Controls the amount of feather effect applied to the edges of the selected garbage matte. Feathering the edges of garbage mattes can smooth the transition from the virtual set, which is a composite of foreground and computer-generated background, to the garbage matte, which is pure computer-generated graphics.

To edit or delete a garbage matte:

1. From the **G. Mattes** drop-down, select the garbage matte you want to edit or delete.
2. Then select **Edit Garbage Mattes**.
3. In the **Edit Garbage Matte** window, enter a new name for the garbage matte and select **OK**.

OR

Select **Delete** to remove the garbage matte and in the confirmation dialog, select **OK**.

Garbage Matte Presets

You can add a **Preset** to be able to move a garbage matte to a saved position as needed. The preset can be applied to any garbage matte. To see a visual representation of the garbage matte preset you are creating, add the **Track Grid** panel to the layout, if it's not already there.

You can also edit the name or position of a preset or delete it.

To add a preset:

1. From the **G. Mattes** drop-down, select **New Garbage Matte**.
2. In the **New Garbage Matte** window, enter a name for the garbage matte and select **OK**.
3. In the **Garbage Matte Data** Fields, enter values to position the garbage matte as needed.
4. Select the **+** icon in the bottom-right corner of the pane.

The **New Garbage Matte Preset** window opens.

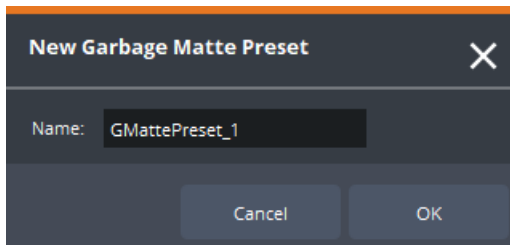

New Garbage Matte Preset

5. Enter a name for the **Preset** and select **OK**.

The position then appears in the **Presets** pane.

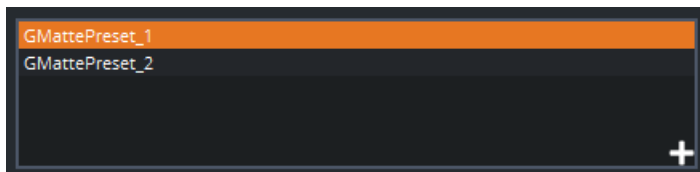

Garbage Mattes Presets Pane

To apply a preset:

1. From the **G. Mattes** drop-down, select the garbage matte to which you want to apply a preset.
2. Then in the **Presets** pane, double-click the preset.

To edit the name of a preset:

1. In the **Presets** pane, right-click the preset you want to edit.
2. From the context menu, select **Edit**.

The **Edit Garbage Matte Preset** window opens.

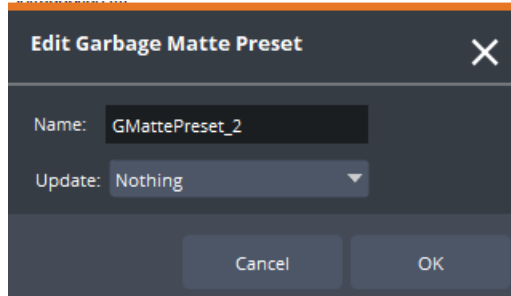

Edit Garbage Matte Preset

3. Enter a new name for the preset.
4. Leave the **Update** drop-down at the default option of **Nothing** and select **OK**.

To edit the position of a preset:

1. In the **Presets** pane, select to select the preset you want to edit.
2. In the **Garbage Mattes Data Fields**, enter new position values for the preset.
3. Then right-click the preset and from the context menu, select **Edit**.

The **Edit Garbage Matte Preset** window opens.

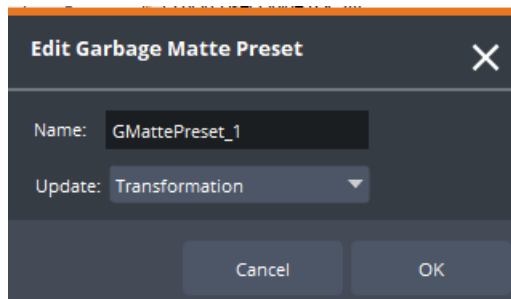

Edit Garbage Matte Preset Position

4. From the **Update** drop-down, select **Transformation** and select **OK**.

Offsets

The **Offsets** button opens a window where you can adjust position and/or rotational offsets. The values are added to their respective global offsets (**Set Offsets** section of the **Track Setup** panel).

For example, if you establish a 30-degree pan offset in your global offsets, but during a production the camera was bumped and rotated 2 degrees, the operational offsets allow you to quickly make this 2-degree tweak (by entering **2.0** in the **Pan** field) while leaving the calibrated 30-degree offset intact.

The following fields are available in the **Offsets** list:

- **Dolly**

This is an offset along the dolly track (not used with Furio tracking systems).

- **Swing, Elevate**

For jib mounts, offset the jib-arm swing (Y-axis rotation) and jib-arm elevate (X-axis rotation).

- **Extend**

For telescopic jib mounts, offsets the jib-arm extension.

- **Pan, Tilt, Roll**

Offset the three degrees of rotation (Y rotation, X rotation, and Z rotation respectively).

- **X Position, Y Position, Z Position**

Offset the camera location in 3D space.

- **FOV, Zoom, Focus**

Lens-related offsets. The **Zoom** value offsets the raw encoder count coming from the lens, before any **FOV** (Field of View) calculation is performed. The **FOV** value, on the other hand, offsets the calculated FOV.

- **Value Change Control**

The **Value Change Control** determines the increment by which change is applied for each click of the **Up/Down** arrows.

To use it, select the input field whose value you want to change, select the desired increment (i.e., how much change should occur for each click of an arrow button - ranging from 0.001 to 100), and then select the up or down arrows to make the change.

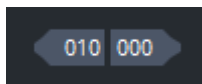

Value Change Control

- **Up/Down Arrows**

These arrows increase or decrease the selected value by the increment chosen in the **Value Change Control**.



Up/Down Arrows

Defocus

The **Defocus** button opens the **Defocus Parameters** window. By default, it also tells the driver for the selected camera to begin outputting depth-of-field detail.

The **Defocus Parameters** are described below:

- **Enable**

When checked, indicates that the defocus effect is activated.

Default is unchecked.

- **Show DOF Marks**

When checked, tells the renderer associated with the selected camera that it should visually display depth-of-field indicators in the scene. Exactly how these indicators appear is renderer-specific, but in general, they allow the user to see how much of the defocus effect is being applied to different parts of the rendered scene.

➤ Blue is the far plane, showing where things go out of focus behind the focus point.

➤ Green is the near plane, showing where things go out of focus in front of the focus point.

➤ Black (in between blue and green) is the actual in focus region.

- **Manual**

Allows you to manually change the lens-related defocus parameters (i.e., **Focus Distance**). If unchecked, these values will be calculated automatically based on the lens-curve data for the lens in use by the selected camera.

- **Circle of Confusion**

Specifies the **Circle of Confusion** value to be used by the renderer's defocus algorithm. In general, the higher this number, the more defocus is applied.

- **Up/Down Arrows**

These arrows control the values in the **Circle of Confusion**, **FNum**, **Distance Offset** and **Focus Distance** fields.

When selecting an up or down arrow, holding the right mouse button down and moving the mouse in any direction will increase or decrease (depending on the arrow) the value more quickly.

- **Value Change Control**

The **Value Change Control** determines the increment by which change is applied for each click of the **Up/Down** arrows.

To use it, select the input field whose value you want to change, select the desired increment (i.e., how much change should occur for each click of an arrow button - ranging from 0.001 to 100), and then select the up or down arrows to make the change.

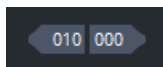

Value Change Control

- **Focus Near/Far**

Read-only fields that show the calculated focus range. The **Near** value indicates the point closest to the camera where objects come into focus. The **Far** value indicates the furthest point where objects are in focus. Any objects closer than the **Near** value or farther away than the **Far** value will be blurred based on the defocus algorithm.

- **FNum**

Specifies the **F-Stop** number to use for the focus calculations.

- **Distance Offset**

Specifies an offset to be applied to the entire focus range. For example, if you entered 5.0, both the near and far values would be offset by 5 feet. A positive value will move the focus range away from the camera, negative will move it closer.

- **Focus Distance**

If the **Manual** checkbox is checked, this slider allows you to explicitly set the distance to the focus point.

If the **Manual** checkbox is not checked, this slider will be grayed out (unavailable), as the focus distance will be automatically calculated.

Floor Presets

In the **Floor Presets** section, you can define and store floor presets for the base of the physical camera mount within the virtual studio, to allow you to change the camera position quickly.

To see a visual representation of the physical camera position you are creating, add the Track **Grid** panel to the layout, if it's not already there. The blue camera icon represents the physical camera position.

This section describes the following procedures:

[Defining Floor Presets](#)

[Saving Floor Presets](#)

[Recalling Floor Presets](#)

[Editing and Deleting Floor Presets](#)

Defining Floor Presets

The floor preset is defined in the following fields:

- **X, Y, Z**

Specify the measured floor position of the base of the selected physical camera mount, in the tracked 3D space.

- **P**

Pan specifies the measured pan of the base of the selected physical camera mount, in the tracked 3D space.

Tilt and **Roll** are not applicable to floor positions.

Saving Floor Presets

Once you've defined a floor preset, you can save it for quick recall on air. Storing a floor preset can only be done with Administrator privileges. See Users for information about user privileges.

To save a floor preset:

1. Select the **+** icon in the bottom-right corner of the **Saved Floor Positions** pane.

The **New Floor Position** window opens.

2. In the **New Floor Position** window, enter the following information:

- **Name** - enter an easily identifiable name for the position (eg. Middle-Front).
- **Duration** - enter the time in seconds that you want it to take for the camera to move from the current position to the selected position.
- **Delay** - enter the time in seconds, to delay the start of the camera move.
- **Ease In/Out** - selects an easing algorithm to be used when a camera is animated from its current position to the new one.

Without any easing applied, the camera will move at a consistent speed from point **A** to point **B**. This can result in animations that look somewhat abrupt at the start and end of the movement. With easing, the camera will gradually accelerate from a standstill at the start, and decelerate to a stop at the end of the movement.

The options are:

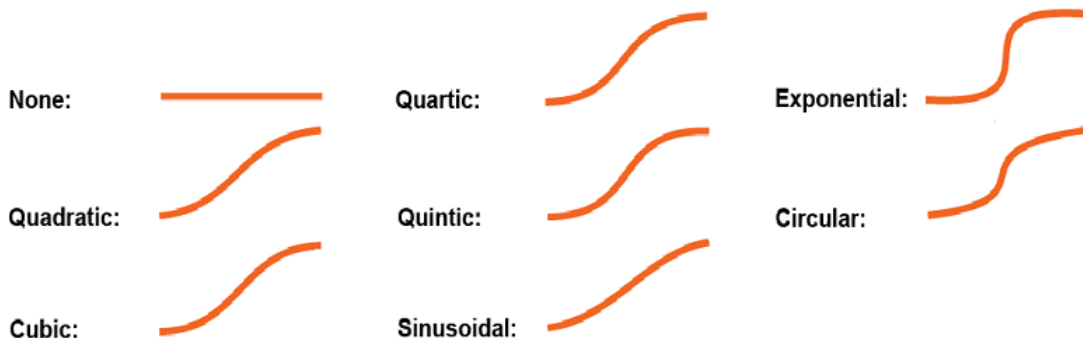

Easing In/Out Options

- **Update Defocus**

When checked, the stored preset will also capture the parameters that control the defocus effect.

3. Press **OK** to save the stored preset.

Recalling Floor Presets

Once you have a floor preset saved, you can quickly recall the preset, moving the camera to the new position.

To recall a floor position:

- Double-click the name of the floor preset you want to use.

Editing and Deleting Floor Presets

Any saved floor preset can be edited or deleted as necessary.

To edit a floor preset:

1. In the **Floor Presets** pane, right-click on the floor preset you want to edit.
2. From the context menu, select **Edit**.

3. In the **Update Floor Preset** editor, change the settings as needed and select **OK**.

To delete a floor preset:

1. In the **Floor Presets** pane, right-click on the floor preset you want to delete.
2. From the context menu, select **Delete** and in the confirmation dialog that opens, select **OK**.

Track Grid

In the **Track Grid** panel, you can define your studio space and see a visual representation of the space in a grid.

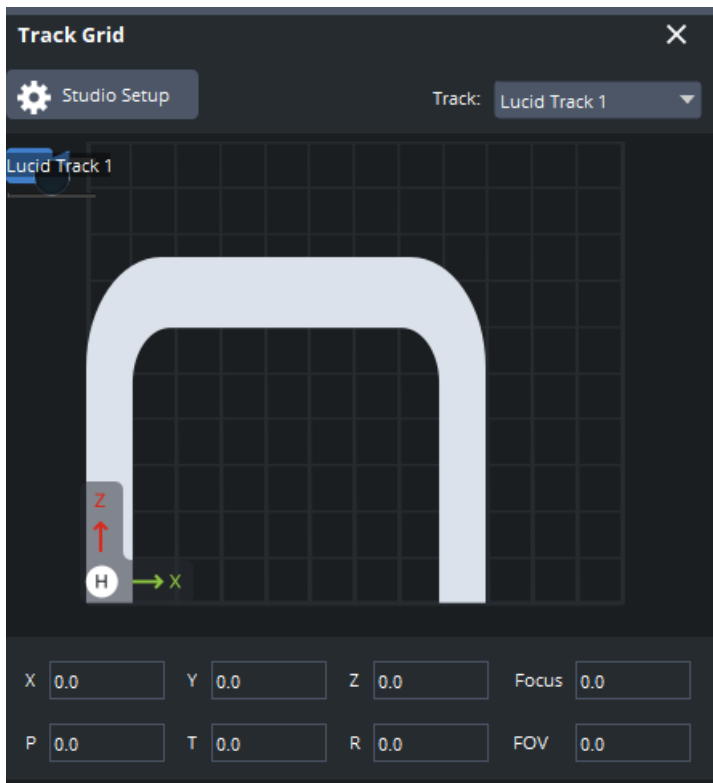

Track Grid Panel

This section describes the following features:

- [Studio Setup](#)
- [Track](#)
- [Grid](#)
- [Feedback Fields](#)

Studio Setup

The **Studio Setup** button opens a tool in which you can enter information about the physical studio space. The information is reflected in the grid creating a visual representation of the studio layout. Studio settings do not affect calibration or how data is calculated. The tool contains the following elements:

- **Studio Dimensions**

Maps the size (in X, Y, and Z dimensions) of the physical studio to the feedback grid.

- **Grid Unit Size**

The size of the grid.

- **Cyc Size**

Defines the size (X, Y, Z) of the cyclorama.

- **Cyc Shape**

Selects the shape of the cyclorama. A top view of the cyclorama will be reflected in the feedback grid.

- **Studio Offset**

Specifies the zero position of the studio (in X, Y coordinates) relative to the back left corner of the room.

- **Cyc Position**

Specifies the X and Z coordinates of the cyclorama's back left corner.

- **Apply to All Tracks**

When enabled, applies the settings to all connected Lucid Track instances. Default is disabled.

Track

The **Track** drop-down allows you to select the instance of **Lucid Track** you wish to control. Any camera-specific configuration parameters or commands will be applied to the selected instance.

★ **Lucid Track** represents the real camera and the **Renderer** represents the virtual camera.

Grid

The grid displays a representation of the tracked space with the cyclorama positioned and shaped as specified. It also shows the real-time position of the selected camera within the space (shown as a blue icon).

Feedback Fields

Below the grid are read-only data fields that provide the following real-time feedback:

- **X, Y, Z:** The calculated final camera position being sent to the renderer.
- **P, T, R:** The calculated final camera rotation (**Pan, Tilt, Roll**) being sent to the renderer.
- **Focus, FOV:** The lens' focus value and calculated FOV of the camera being sent to the renderer.

Position

The **Position** panel enables the manipulation of items in the virtual studio. Only those items that have been published in the renderer will appear in the **Position** panel.

★ When items have been published or unpublished in the virtual studio, their status is automatically updated in Lucid Studio.

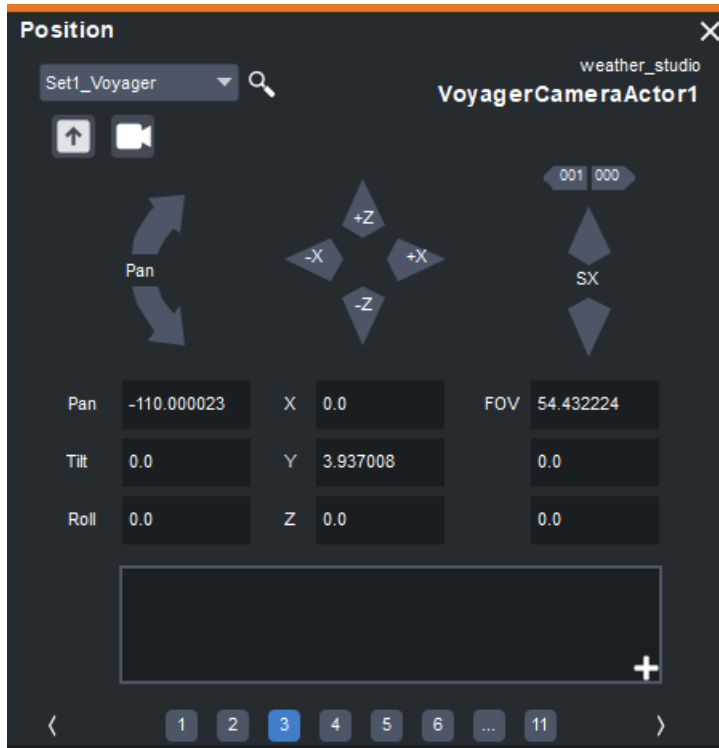

Position Panel

The panel is essentially a window into a number of sets. The panel shows controls for one item at a time. The number buttons at the bottom reflect how many pages exist in the set. If there are more than 7 pages in the set, a **Browse** button appears, allowing you to select further pages.

Item Types

There are five types of items that can be manipulated in the **Position** panel:

- **Objects** - virtual 3D items
- **Cameras** - representing the perspective from which the entire virtual scene is viewed
- **Text** - headings, subheadings, etc.
- **Lights** - virtual lights that can be turned on or off and change in color and intensity
- **Movable** - items that have been configured as movable in Voyager (in Voyager versions 4.26 and newer). For information on how to configure items as movable, see the Voyager documentation.

★ Any values that are being controlled through a logic graph will appear in red in the **Position** panel and will not be editable. They can be edited in the logic graph or in the associated file.

Position Panel Components

The **Position** panel components are described below:

- **Set drop-down**

The **Set** drop-down allows you to create, select or edit a set of items.

- **Search icon**

Brings up a list of all the published items in each set to make it easier to find a specific item.

- **Display Name and ID Name**



At the top-right corner of the panel is the scene name and item name. If the name doesn't fit, the last part of the name will be displayed, preceded by an ellipsis and the full name can be seen as a tool tip when you hover over the name.



In Voyager, an item has 2 names: an **ID Name** and a **Display Name**. It is possible to have 2 items with the same **Display Name** but a different **ID Name**.

Lucid Studio uses the **Display Name** of the item and when you hover over the name, the **ID Name** is displayed as a tooltip.

- **Icons**

There are a number of icons displayed beneath the **Set** drop-down, which differ depending on the selected item. They are described in the table below:

Control	Name and Where Found	Description
	Foreground/Background (Object and Text items)	External Compositing This button controls whether the item appears in front of the physical items seen by the camera (foreground), or behind them (background). The icon on the button toggles to represent the current state, showing either a full figure of a person (foreground) or a partially obscured figure (background). Using this button during a live production, you can enhance the realism of virtual objects in the scene. For example, you can have the talent walk out from behind an item (with the item in the foreground), and then turn and walk in front of the item (with the item set to background). Internal Compositing Toggles visualization of the composite plane, making it either white or transparent.
	Visible/Hidden (Object, Text, and Light items)	Controls whether the item is visible or not. The icon on the button shows either an open eye (visible) or a closed eye (hidden).
	Write (All items)	Write the properties of the item to a CSV or XML file, which is saved by default to: C:\ROSS\Lucid\Lucid Studio. See To write item properties to a file for more information.

Control	Name and Where Found	Description
	Change Text String (Text items only)	<p>Opens a window containing a drop-down with two options for changing text:</p> <p>Text - type the text you want to add to the scene directly in the window.</p> <p>CSV - point Lucid Studio to a .csv file that contains the text you want to add to the scene - changes to the file can be dynamically accessed from Lucid Studio.</p> <p>User Input Control - configure user input controls to allow easy selection of text (from a static or global list or DataLinq source) to add to the scene.</p> <p>See User Input Control for more information.</p> <p>Text changes can be updated automatically as you type by selecting the Auto Send checkbox or manually when you're ready by selecting the Send button.</p>
	Light Properties (Light items only)	<p>Change the RGB color values and intensity of a light.</p> <p>These settings are supported in Voyager version 3.0 and XPression version 8.0 and newer.</p> <p>You can enter the RGB values in the appropriate fields or left-click on the rectangle to the left of the RGB fields to open a Color Selector and choose your color from there.</p> <p>After selecting a new color, right-clicking will return the light item to its original color.</p>
	Activate Camera (Camera items only)	<p>Selects the camera view that will be output by the renderer.</p> <p>For example, you might have three virtual cameras defined within your scene/project, Cam_1 (which is receiving the physical camera position data and is currently selected), Cam_2, and Cam_3, each of which has a different position, rotation, and FOV setting.</p> <p>If you select the Activate Camera icon for Cam_2, the renderer will output the view of Cam_2, but the camera position data is still going to Cam_1. Switching to a different camera output gives the illusion that a stationary camera is moving.</p> <p>The same effect can be achieved in a more flexible way (i.e., with animations) by simply defining multiple stored positions for a single virtual camera.</p>

- **Position Control Block**

Below the icons is a standard set of position/rotation controls. Moving, rotating or scaling an item is done from the item's pivot point.



Position Control Block

The **Position Control Block** includes:

- **Two curved arrows for changing rotation values**

These curved arrows allow control of item rotation. They will change values in the selected rotation field (**Pan**, **Tilt**, or **Roll**), with **Pan** being the default.

The label for the selected rotation field will be displayed between the two curved arrows. If, for example, you select the **Tilt** field, the label **Tilt** will be displayed between the arrows.

- **Four arrows in a star formation for changing position values**

By default, the left and right arrows within this star control movement along the **X-axis**. Selecting these arrows moves the item along this axis and changes the value shown in the **X** field.

The up and down arrows in the star move the item along either the **Y-axis** (vertically relative to the floor) or the **Z-axis** (forward and back along the floor) depending on which field has been selected and change the values in the selected field. The labels within the arrows confirm the selection.

The position change is relative to the world orientation, not the camera orientation. If the camera orientation is not aligned with the world, changing the X value could move the item forward/backward.

- **Up/down arrows**

These arrows control the scale (size) of object and text items in the **X**, **Y**, and **Z** dimensions.

The label for the selected scale field (**SX**, **SY**, and **SZ**) will be displayed between the up/down arrows. If for example, you select the SX field, the label SX will be displayed between the arrows.

For camera items, the up/down arrows change the **FOV** value.

The up/down arrows are not applicable to light items.

When selecting an up or down arrow, holding the left mouse button down and moving the mouse in any direction will increase or decrease (depending on the arrow) the value more quickly.

- **Value Change Control**

The **Value Change Control** determines the increment value by which change is applied for each click of the arrows. This value affects all arrows in the **Position Control Block**.

To use it, select the input field whose value you want to change, select the desired increment (i.e., how much change should occur for each click of an arrow button - ranging from 0.001 to 100), and then select the up or down arrow to make the change.

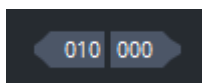

Value Change Control

- **Position Data Fields**

Below the **Position Control Block** is an array of data fields arranged in three columns for rotation, position, and scale (or FOV for camera items) respectively.

Values in the **Position Data Fields** that have been set by Visual Logic are displayed in red. These values are locked and can only be changed in the source data text file referenced by the logic graph.

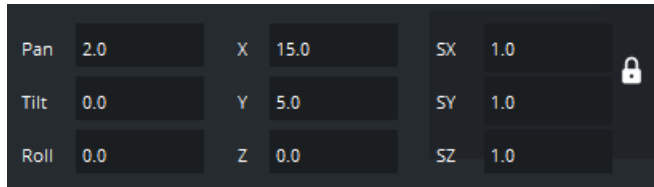

Position Data Fields

➤ **P, T, R (Pan, Tilt, Roll)**

These fields contain values that reflect the rotation of the item

➤ **X, Y, Z**

These fields contain values that reflect the item’s position in 3D space.

➤ **SX, SY, SZ**

These fields contain values that reflect the scale applied to the item. If, for example, the item was designed to be two feet tall in the scene project, changing the SY value to 2.0 will make the item appear four feet tall.

➤ **Scale Lock Control**

To the right of the scale values is a padlock icon. The padlock can appear either locked (closed), unlocked (open) or blue.

Icon	Meaning
	Changing the value of one axis will change the others to the same value.
	The value of each axis can be changed individually.
	Changing the value of one axis will change the value of the others to maintain the original aspect ratio.

➤ **FOV**

Only virtual cameras have this single FOV (field of view) data field.

The FOV arrows (also used for **Scale**) control this value when it is selected.

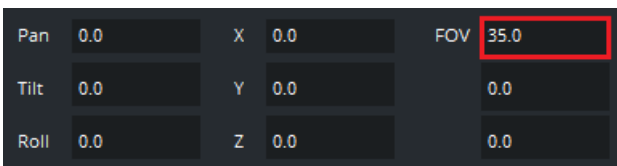

Position Data Fields - FOV

- **Item Position Presets**

Below the data fields is a pane in which you can add item positions presets. This list allows you to capture and then recall, any number of different item positions within the virtual scene.

When adding positions for the virtual camera (which represents the perspective from which the entire virtual scene is viewed), animated moves from one camera position to another can be quite dramatic.

If, for example, the camera is on the left side of the scene low down toward the floor, and you execute a five-second animated move to high on the right side of the scene, you will see a dramatic sweep of the scene from the camera's perspective.

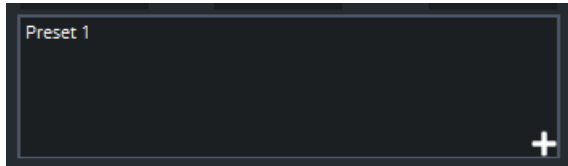

Position Presets Pane

Capturing/Adding an Item Position

Only Administrators and Operators can capture/add a new item position. Administrators can edit or delete any position. Operators can only edit or delete positions they have created.

See [Users](#) for more information about user privileges.

Positions can be recalled as needed.

Managing Items in the Position Panel

When adding items to the panel, you can group them into sets. Each set can contain up to 30 items. Sets can be renamed and their content changed. Items within the sets can be reordered.

You can also add an empty actor to a set, allowing you to manipulate a number of items at the same time (supported in Voyager versions 4.27 and newer).

This section describes the following procedures:

[Adding a set](#)

[Adding items to a set](#)

[Going to an item in the Position panel](#)

[Searching for an item](#) (applies to Voyager versions 4.26 and newer)

[Capturing an item's position](#)

[Recalling an item position](#)

[Editing an item position](#)

[Reordering an item position](#)

[Deleting an item position](#)

[Renaming a set](#)

[Editing a text item directly](#)

[Drawing text from a .csv file](#)

[Writing item properties to a file](#)

To add a set:

1. From the **Set** drop-down, select **Edit Sets**.
The **Position Sets & Items** panel opens.
2. Select the **+** icon in the bottom-right corner of the **Sets** pane.
3. In the **New Position Set** window, enter a name for the set and select **OK**.
4. Select **Close** or the **X** in the top-right corner to exit the panel.

To add items to a set:

1. From the **Set** drop-down, select **Edit Sets**.

The **Position Sets & Items** panel opens.

2. In the **Sets** list, select the set to which you want to add items.
3. In the **Items in Set** list, select the **+** icon in the bottom-right corner.

The **Selection** panel opens.

4. From the drop-downs at the top of the panel, select the type of item you want to add and the renderer from which to draw the items (if there is more than one renderer connected).

A list of folders that are available in that renderer is displayed. Selecting the icon just before the list menu for the item type selection will change the list of items found in the selected renderer from folder to an alphabetically ordered list view, making it easier to find items.

★ Only those items that have been published in the renderer will be displayed.

5. Expand a folder to navigate to the item you want to add or select the icon to the left of the drop-downs to expand all the folders at once.

Alternatively, you can begin entering the name of the item in the **Search** field to filter the results and quickly find the item you want.

6. Double-click the item.

OR

Select the item and then select **ADD**.

If there is an item in the project that has the same internal name as the item you are trying to add, the following notification appears.

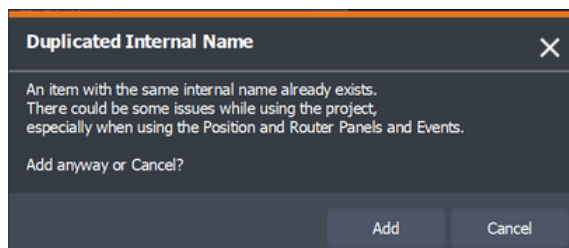

Duplicated Names - Position Panel

★ If you select **Add**, the following dialog appears, warning that adding an item with a duplicate internal name could cause some issues in the project. Select the warning to close the dialog.

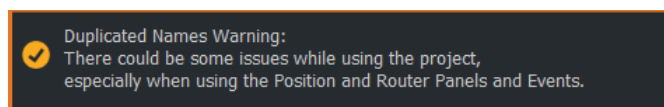

Duplicated Names Warning

7. Select **Cancel** to avoid adding an item with a duplicate internal name and select another item.

The item appears in the **Items in Set** panel.

8. Select **Hide** to close the **Selection** panel and then **Close** to exit the **Position Sets & Items** panel.

To go to an item in the Position panel:

1. At the bottom of the panel, select the number button corresponding to the page containing the item.



Page Number Buttons

2. If the page number is higher than 7, select the **Browse** button.

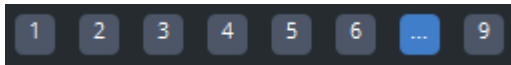

Page Browse Button

If the **Position** panel is occupying one cell in the layout, each page will contain only one item. If you expand the panel to occupy two or more cells, each page will contain the corresponding number of items.

To search for an item:

1. From the **Set** drop-down, select the set containing the item you want to find.
2. Then select the **Search** icon.

A window opens with the list of items in the selected set.

3. In the **Search** field, start typing the name of the item.

Items beginning with the entered characters will be displayed in a list.

★ Only those items that have been published in the renderer will be displayed.

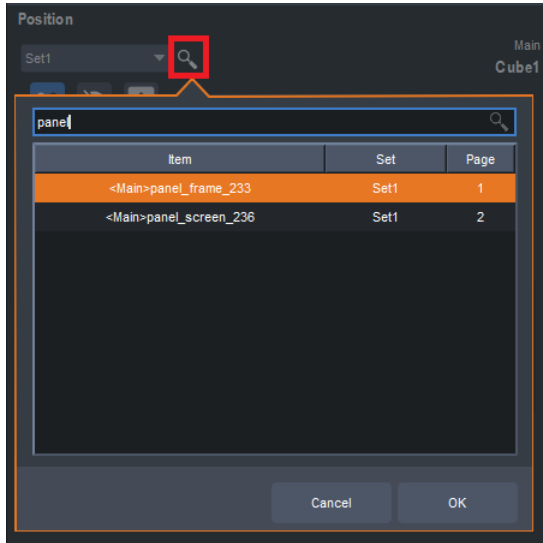

Position - Search

4. Use the keyboard **Up/Down** arrows to move the highlight to the item you want and then press **Enter** to go directly to that page in the **Position** panel.

Alternatively, you can move the mouse to the item you want and double-click to select it and go to the page.

To capture an item's position:

1. Set the item's position by changing the rotation, position, and scale values in the [Position Data Fields](#).

You could also capture the item's current position without changes.

If you have selected the **auto create new item preset** option in the [Lucid Setup > Lucid](#) tab, the current position of any item added to the **Position** panel after selecting the option, will automatically be saved to a preset called **Original**.

2. Then select the **+** icon in the lower-right corner of the **Item Position Presets** pane.

If the **+** is not there, you are not logged in as the Administrator.

The **New Position Preset** window opens.

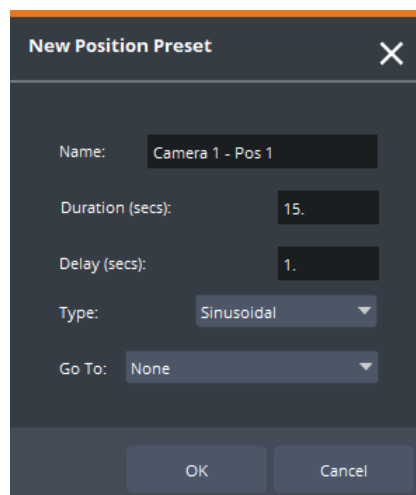

Add Item Position Preset

3. In the **Name** field, enter a descriptive name for the position.
4. In the **Duration** field, enter the amount of time (in seconds) it should take for the item to move from the current position to this new position.

For example, if you enter **2.0** in this field, then whenever this position is recalled, the item will take two seconds to get to this position.

Leaving the value at **0.0** will result in a cut from the current position to this new position.
5. In the **Delay** field, enter a delay (in seconds) to be applied before the item moves from its current position to this new position.

For example, if you enter **3.0** in this field, then whenever this position is recalled, the item will remain in its current position for three seconds before beginning its move to the new position.
6. From the **Ease In/Out** drop-down, select an easing algorithm to be used when an item is animated from its current position to this new one.

Without any easing applied, the item will move at a consistent speed from point A to point B. This can result in animations that look somewhat abrupt at the start and end of the movement. If you apply easing, the item will gradually accelerate from a standstill at the start, and decelerate to a stop at the end of the animated movement.

Experiment with different easing algorithms to find the desired animation effect.

7. From the **Go To** drop-down, select an option to move the item to a new location (optional).

Selecting **Back to Original** will move the current item to its original start-up position.

Selecting another item will move the current item to the same position as the selected item.

Selecting **Tracked Camera** will move the current item to the same position as the tracked camera.

Light items that are set to go **Back to Original** return to their original position only, not to the original light color property.

This allows you to move items in 3D space that are far apart by pointing to another item. This requires less manual position control.

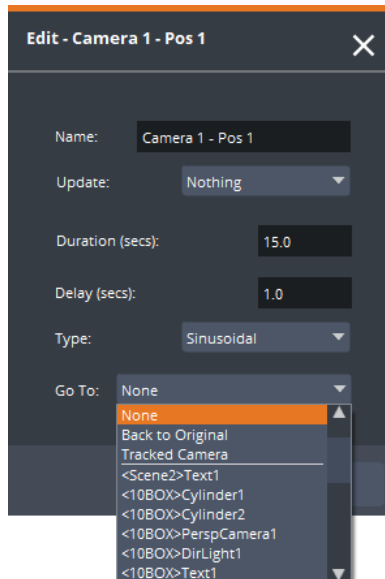

Go To Drop-down

8. Press **OK** to save the item position.

After saving a new position, you will see the name you entered appear in the list of item positions.

To recall an item position:

- Double-click the item position in the list.

The item moves to the new position (with animation, if defined in the position).

To edit an item position:

1. Right-click on a position in the list.
2. Select the **Edit** button.
3. Change the parameters of the position.
4. From the **Update** drop-down, select whether you want to update:
 - **Nothing**: All properties will stay the same.
 - **Transformation**: The **XYZPTR** values will be updated as well as any changes to the **Duration**, **Delay** and **Ease In/Out** values.
5. Select **OK** to save your changes.

To reorder an item position:

1. From the **Set** drop-down, select the set containing the item whose order you want to change and select **Edit Sets**.
2. In the **Items in Set** pane, select the item you want to reorder.
3. Left-click and drag it to a new position in the list and release the mouse button.

To delete an item position:

1. From the **Set** drop-down, select the set containing the item you want to delete and select **Edit Sets**.
2. In the **Items in Set** pane, select the item you want to delete.
3. Right-click the item and select **Delete**.
4. In the confirmation dialog that opens, select **OK**.

To rename a set:

1. From the **Sets** drop-down, select the set you want to rename and select **Edit Sets**.
2. In the **Sets** list, right-click on the set and select **Edit**.
3. In the **New Position Set** window, enter a new name for the set and select **OK**.

To edit a text item directly:

1. Select the text item you want to edit from the number icons at the bottom of the panel.
You can also use the scroll arrows to move through the items.
2. Select the **Text** icon.

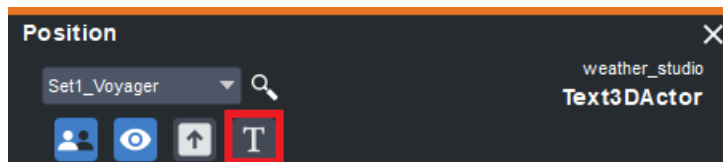

Text Icon

3. From the drop-down, select **Text**.



Select Text

4. Select the **Auto Send** checkbox if you want the new text to be added to the scene as you type it or deselect the checkbox if you want the text to only be added when you select **Send**.

5. Select the text in the window and type in your new text.
 - If you selected **Auto Send**, the new text will appear in the scene as it's entered.
 - If you deselected **Auto Send**, the change will only appear after you select **Send**.
6. Select the **Text** icon again to close the window.

To draw text from a .csv file:

1. Select the text item you want to edit from the number icons at the bottom of the panel.
You can also use the scroll arrows to move through the items.
2. Select the **Text** icon and from the drop-down, select **CSV**.



Text Icon

3. Select the **Browse** button beside the **CSV File** field.
The **Select File** window and the **CSV Parsing Options** window open.
4. In the **Select File** window, navigate to the **.csv** file containing the content for your text item and select **Open**.
5. In the **CSV Parsing Options** window, select the options for how the text is displayed and when you have finished, select **OK**.

See [Parsing Options](#) for more information.



CSV Parsing Options

A window opens displaying the **CSV** file parameters:

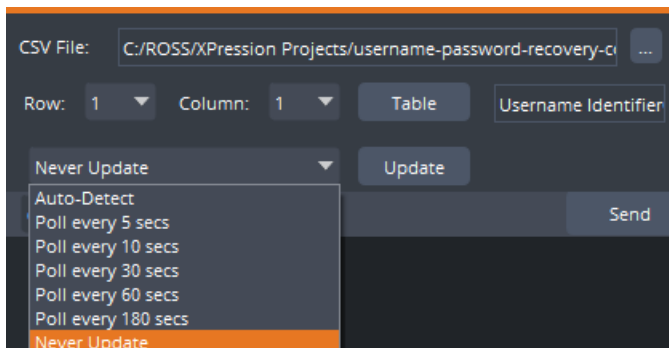

CSV File Parameters

6. From the **Row** drop-down, select the row of the **.csv** file that contains the text you want to use.

Alternatively, you can select the **Table** button to see a representation of the **.csv** file and double-click a cell to select the content you want to use.

7. From the **Column** drop-down, select the column of the **.csv** file that contains the text you want to use.

Alternatively, you can select the **Table** button to see a representation of the **.csv** file and click a cell to select the content you want to use.

The text contained in the selected row and column appears in the **Preview** field to the right of the **Table** button.

8. From the **Update** drop-down, select the frequency with which Lucid Studio should poll the **.csv** file for changes to the text.

The options are:

- **Never Update** (recommended if you only want the text to be updated manually by the operator)
- **Auto-Detect** (recommended for local drives only; text will be updated as soon as any parameter is changed)
- **Poll every 5 secs**
- **Poll every 10 secs**
- **Poll every 30 secs**
- **Poll every 60 secs**
- **Poll every 180 secs**

The **Preview** window is updated as soon as any parameter is changed.

9. Select the **Auto Send** checkbox to have the new text added to the scene as soon as it is read or clear the checkbox if you want the text to be sent manually by selecting **Send**.

10. Select the **Text** icon again to close the window.

To write item properties to a file:

1. Select the item whose properties you want to write to a file from the number icons at the bottom of the panel.

You can also use the scroll arrows to move through the items.

2. Select the **Write** icon.

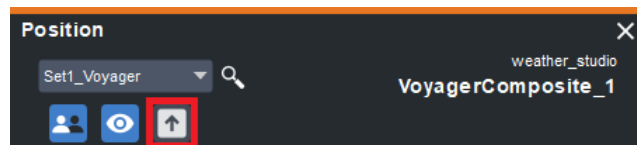

Write Icon

The **Write** parameters window opens.

3. From the drop-down, select whether to save the properties in a **CSV File** or an **XML File**.

For CSV Files:

a. Select the parsing options for how you want a table to be displayed. See [Parsing Options](#) for more information.

- b. Then select the **Browse** button beside the **CSV File** field and navigate to the location where you want to save the file.
- c. Enter a name for the file and select **Save**.

For XML Files:

- a. Select the **Browse** button beside the **XML File** field and navigate to the location where you want to save the file.
- b. Enter a name for the file and select **Save**.

4. Select the **Write** icon again to close the window.

Parsing Options

- **Delimiter** - selects the key stroke that is used to separate the text fields, either a comma, colon, semi-colon or tab.

For example, if **Comma** is selected, the following CSV text:

Monday, Tuesday, Wednesday, and Thursday are work days.

appears in the table as:

	1	2	3	4
1	Column1	Column2	Column3	Column4
2	Monday	Tuesday	Wednesday	and Thursday are work days.

The commas place the text preceding them into separate cells.

- **Text Quotation** - selects whether to use **Normal** (double quotation marks) or **Apostrophes** to identify a block of text in which you want the selected **Delimiter** (a comma for example) to be ignored and treated as regular punctuation. This will place the block of text in one cell.

For example, if **Comma** and **Normal** are selected, the following CSV text:

"Monday, Tuesday, Wednesday, and Thursday are work days."

appears in the table as:

	1	2
1	Column1	Column2
2	Monday, Tuesday, Wednesday, and Thursday are work days.	

The opening and closing quotation marks around the sentence cause the commas to be treated as regular punctuation and moves the text into one cell.

- **Escape Quotes** - selects whether to use **Two** signs (double the character chosen from the **Text Quotation** drop-down) or a **Backslash** to signify escape from the usual CSV function of the quotation marks. This character ignores the CSV function of **Normal** or **Apostrophe** selected as **Text Quotation** and treats them as regular punctuation.

For example, if **Comma**, **Normal** and **Backslash** are selected, the following CSV text:

"Monday, Tuesday, Wednesday, and Thursday are \"work\" days."

appears in the table as:

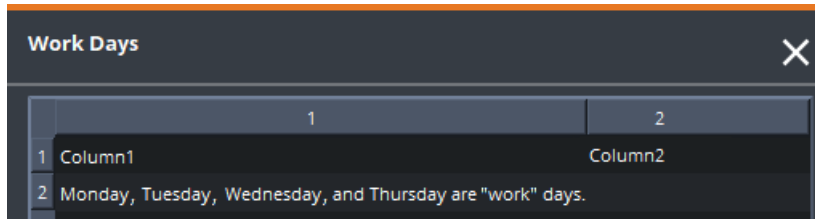

	1	2
1	Column1	Column2
2		Monday, Tuesday, Wednesday, and Thursday are "work" days.

The opening and closing quotation marks around the sentence cause the commas to be treated as regular punctuation and moves the text into one cell.

The backslashes preceding the opening and closing quotation marks around the word "work" cause those quotation marks to be treated as regular punctuation.

- **Encoding** - selects which encoding method to use to replace existing character sets.

Events

The **Event** panel allows users to configure up to 40 pages, each containing 20 **Event** buttons (800 buttons in total).

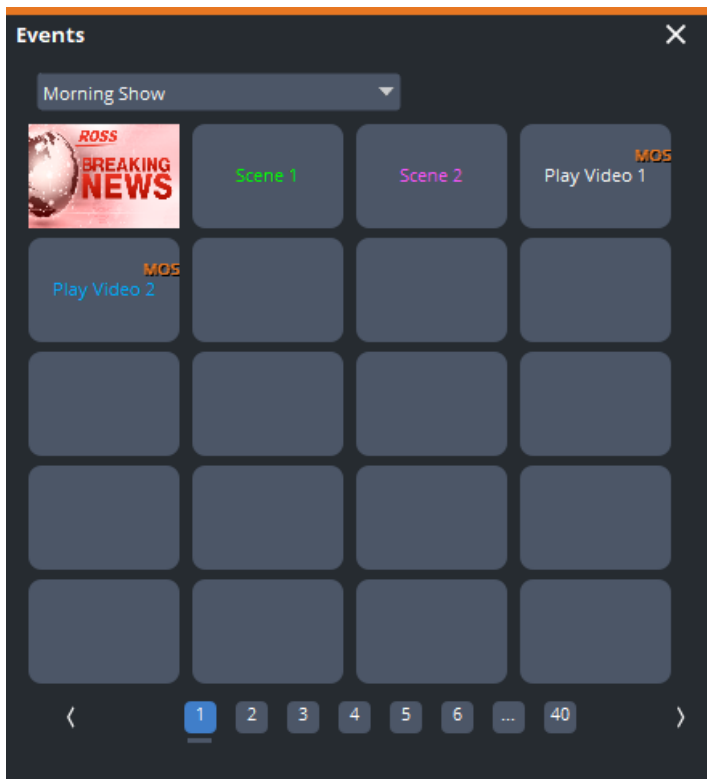

Events Panel

This section contains the following topics:

[Event Page Navigation](#)

[Event Page Editing](#)

[Event Editing](#)

Event Page Navigation

The event pages can be navigated using the drop-down in the upper-left corner of the panel or by selecting the directional indicators and page indicator icons at the bottom of the panel.

When using the drop-down, pages containing content are indicated by the use of bold, white font as shown in the image below.

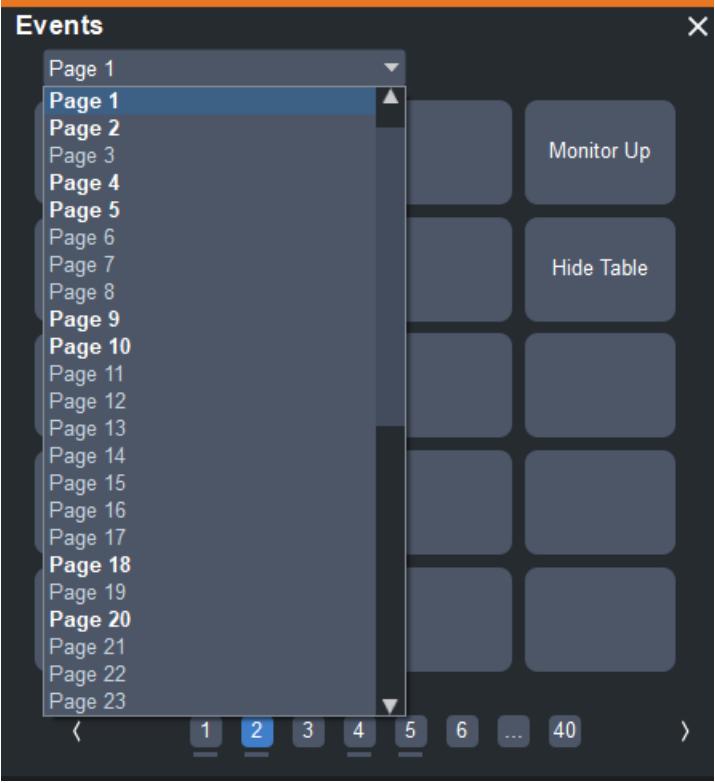

Events Page Drop-Down

Event Page Editing

Page names and order of pages can be edited from the drop-down in the upper-left corner of the panel.

To rename an event page:

1. Select in the **Page** drop-down.
2. Scroll to the bottom of the page list and select **Edit**.
3. In the **Edit Events Pages** window, right-click the page you want to rename and select **Edit**.
4. In the **Rename Events Page** window, enter a new name for the page and select **OK**.
5. Select **Close** to exit the **Edit Events Pages** window.

To reorder pages:

1. Select in the **Page** drop-down.
2. Scroll to the bottom of the page list and select **Edit**.
3. In the **Edit Events Pages** window, select a page and drag it to a new position.
4. Select **Close** to exit the **Edit Events Pages** window.

To publish events to the Web API:

1. Select in the **Page** drop-down.
2. Scroll to the bottom of the page list and select **Edit Web API events**.
3. In the **Edit Events Published in Web API** window, expand the pages to view the events on each page.

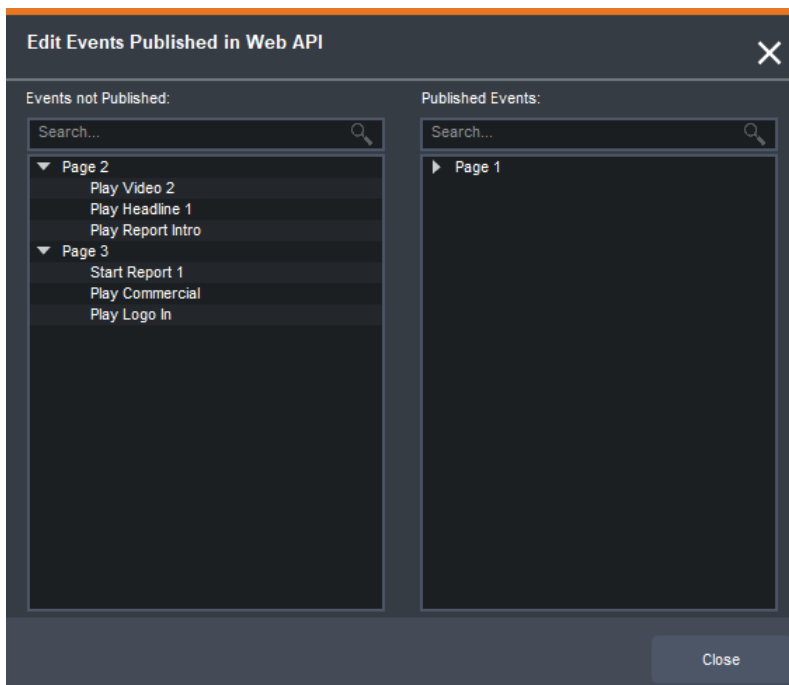

Edit Events Published in Web API

4. Select and drag an event from the **Events not Published** list to the **Published Events** list.

Alternatively, you can press **Shift** and select multiple events or select a page to move all the events on a page to the **Published Events** list.

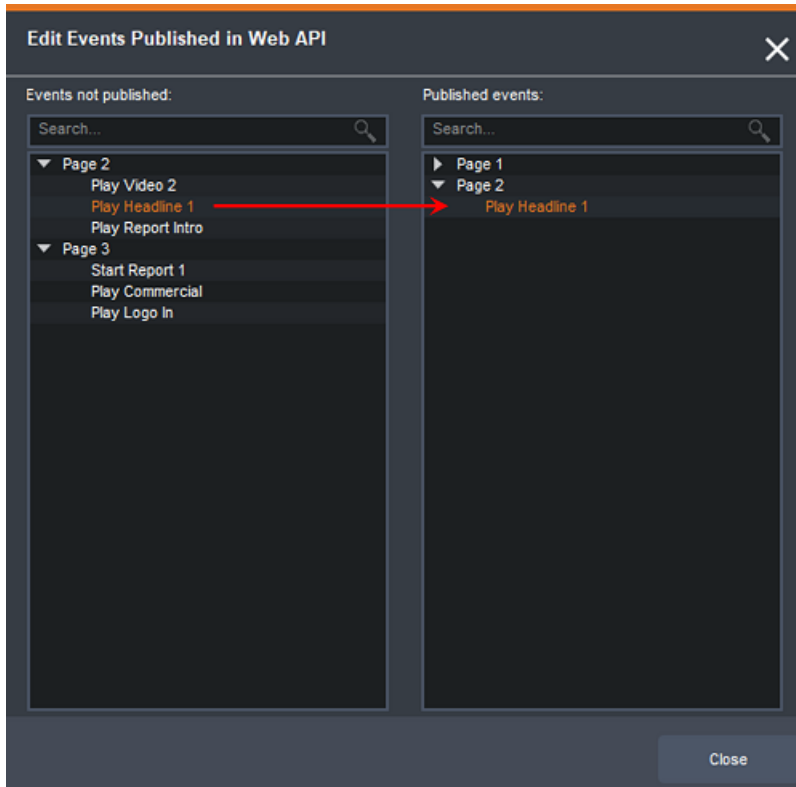

Publish Event

5. Select **Close** to exit the **Edit Events Published in Web API** window.

To remove events from the Published Events list:

- Select the page or event(s) you want to remove and drag them back to the **Events not Published** list.

Event Editing

You can edit existing events or create new ones using the **Event Editor**. The **Event Editor** is accessed by right-clicking an event button in the panel.

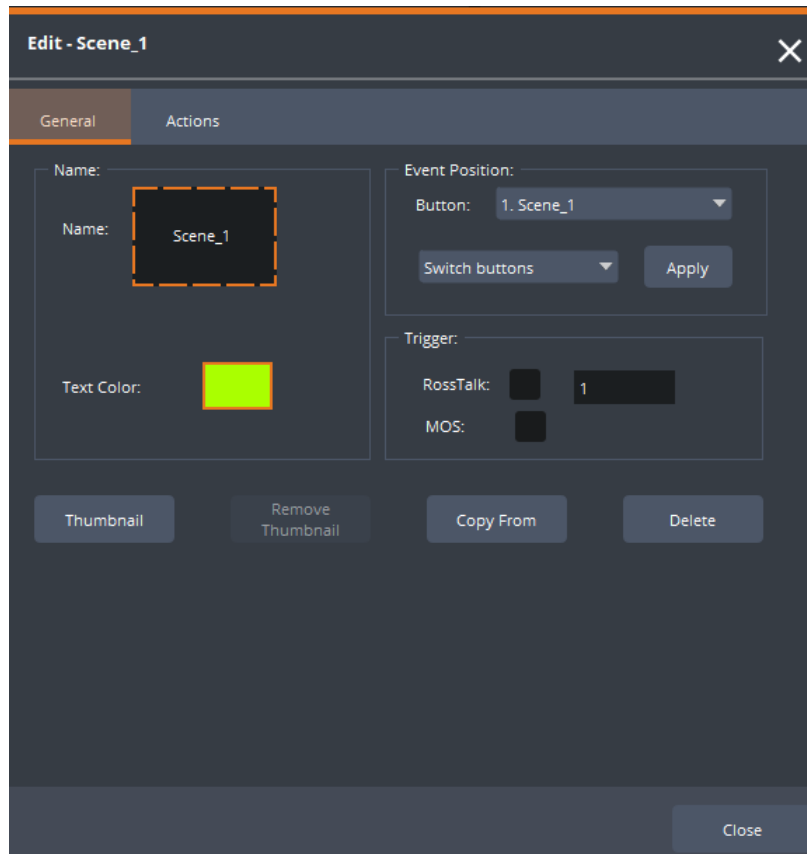

Events - Event Editor

The **Event Editor** contains the following tabs:

[General Tab](#) (opens by default)

[Actions Tab](#)

General Tab

In the **General** tab you can give the event button a name and text color, change the button's location, specify a trigger for the event, add and remove thumbnail images for the event buttons and delete buttons.

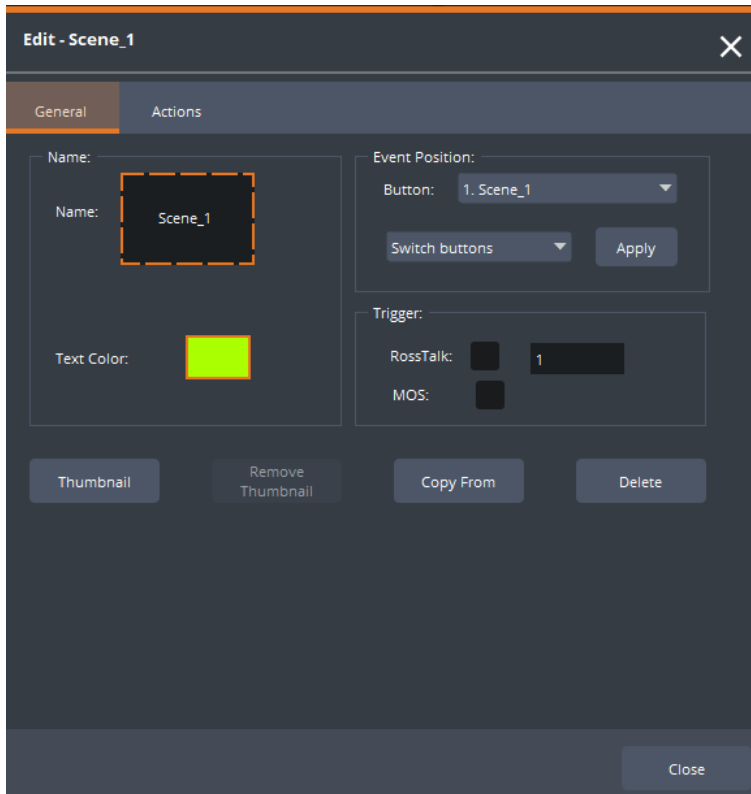

Events Editor - General Tab

Name

The event name is saved automatically when it's changed.

This name will appear on the event button and in the Sequencer panel if the event has been added to a sequence, so it's best to choose concise names.

To name an event button:

1. In the **Name** field, select the default name and enter a new name.
2. If the name is too long to fit on one line in the button, press **Enter** to move one or more words to another line.
3. Select the **Text Color** block to open the **Color Selector**.
4. Select a color for the event name and select **OK**.
5. Select **Close** to exit the editor.

Event Position

You can move the event button to another position on the same page or to a different page.

To move an event:

1. Right-click the event button.
2. In the **Event Position** section, the **Button** drop-down indicates the current position of the button.
3. From the **Button** drop-down, select the page and button position on which you want the event to appear, for example, **Page 3-1**.
4. Then select one of the options below and select **Apply**:
 - **Switch buttons**: Switches the event to the selected page and position.
 - **Displace to right**: Offsets all following events by one cell, to allow the selected event to get to the new position.

Trigger

Events are typically triggered manually when the Lucid Studio operator presses the appropriate event button. In this case, nothing needs to be done in the **Event Trigger** settings. In automated settings, you'll need to configure the Trigger for either RossTalk commands or MOS events.

RossTalk

In an automation system like Ross OverDrive, you can have Lucid Studio operate under the control of the automation system or remotely trigger an event from an external application like DashBoard.

To configure an event for external triggering by an automation system:

1. Select the **RossTalk** checkbox.
2. In the **ID** field, enter the **ID** of the RossTalk message that will trigger the event.

This number must match the number defined in and used by the automation system for this event.

The settings are saved automatically when they're changed.

★ If the **RossTalk Trigger** checkbox is cleared, the message ID is saved and when the **RossTalk Trigger** checkbox is again selected, the RossTalk message will again become active.

MOS

To make an event available for use in a Newsroom Control System (NCS), select the **MOS** checkbox. A **MOS ID** is automatically created for the event. In the NCS, a Lucid tab is created listing the MOS-enabled events.

★ The **Published Field** checkbox in the event action must also be selected to make the action available in an NCS.

The event button displays a MOS indicator in the top-right corner.

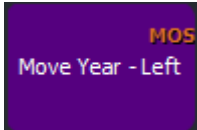

Event Editor - MOS Trigger Indicator

Thumbnail

Select this button to navigate to a thumbnail image to be applied to the event button. This image typically is representative of the event as a whole and will appear in the **Sequencer** panel, if the event is added to a sequence. The thumbnail image will be embedded in the Lucid Project File (**.uxp**) to allow its portability without having to copy thumbnail files into the project.

The image can come from a file or directly from a Voyager renderer. Select the **Thumbnail** button and select **File** or **From Renderer** to select the renderer from which you want to copy the image.

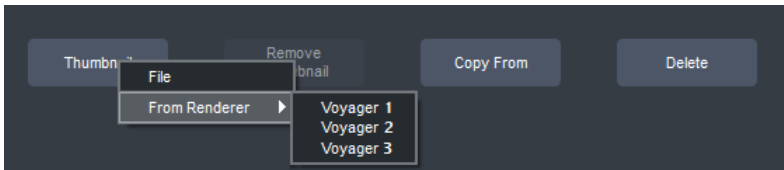

Event Thumbnail from Voyager

If the event button has a name, when you add the thumbnail image, an optional checkbox appears that, if selected, hides the name.

Remove Thumbnail

Deletes the thumbnail image from an event button.

Copy From

Duplicates the properties and actions of an existing event, except for the name.

Delete

Deletes an event. Once an event is deleted, its button will revert to the standard inactive look, and will be completely deactivated.

Actions Tab

The **Actions** tab allows a number of actions to occur with the press of one event button and provides the flexibility to control how each action within the event is performed.

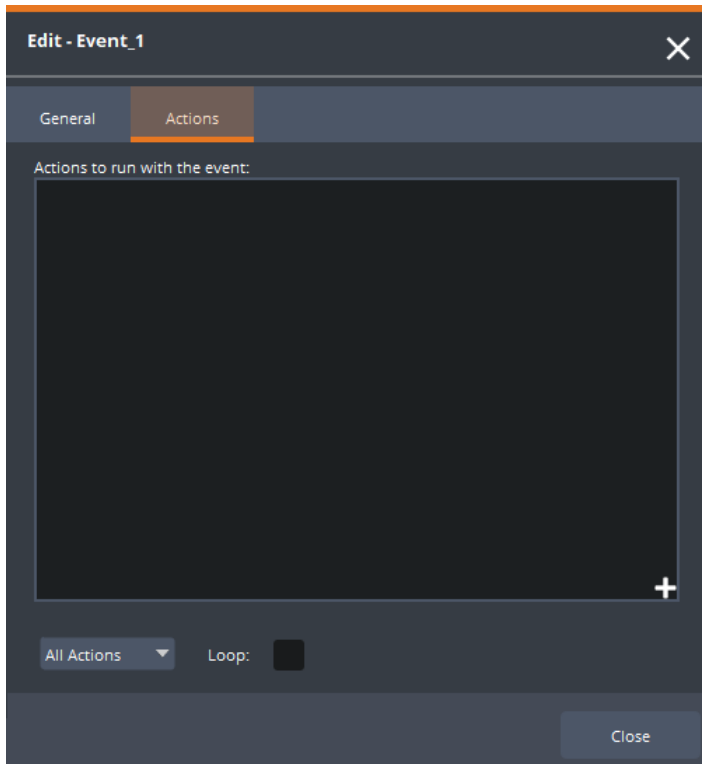

Event Editor - Actions Tab

- **Actions to run with the event:** This scrolling list contains the actions to be run by this event, above and beyond any base action assigned to the event. When you are creating a new event, there is no base action.
- Located below the **Actions to run with the event** list, is a drop-down that allows you to select a mode of execution for the actions in the list. The available modes are described below:
 - **All actions**

All actions will be executed immediately (at the same time as pauses, if any).
 - **As playlist**

Actions will be executed one at a time, for each button press. This allows the operator to control a defined play list all within a single event.

When this mode is selected, the **Next Action** indicator appears. This is a read-only element that indicates which action will be played next.

In addition, the **Reset** button appears. This resets the playlist, making the first item in the list the next action.

Play lists cannot be triggered by a MOS event.
 - **Loop**

Specifies whether the playlist should loop back to the top when the bottom of the list is reached.

To add actions to an event:

1. Select the + sign in the lower-right corner of the pane.

The **Action Editor** opens with the **Event** type displayed.

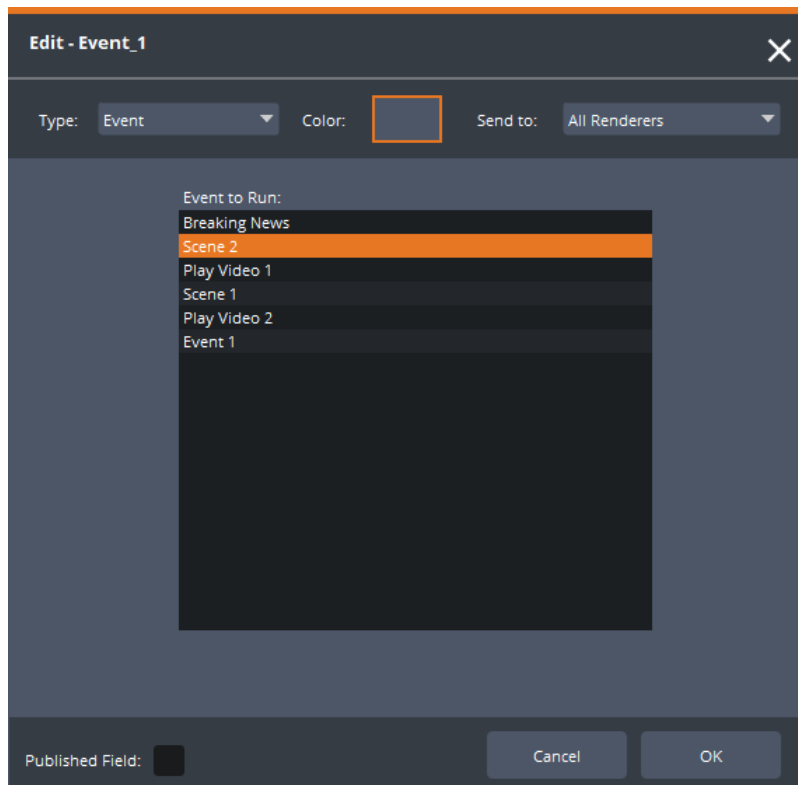

Action Editor

2. From the **Type** drop-down, select the type of event you want to run.

The options are:

Event (default)	Renderer	Chroma
Router	Sequencer	Color Correction
Position	Logic	Video Walls
Floor	Pause	Script
G.Mattes	Send	Misc
Animation	Robotics	

Some of these event types (**Event**, **Router**, **Position**, **Sequencer**, **Misc**) mimic the capabilities in the **Event**, **Router**, **Position** and **Sequencer** panels.

Depending on the action type selected, the remaining elements in the editor change, except for the **Color** checkbox, which is common to all types. Selecting the **Color** checkbox opens a standard **Color Selector** window, from which you can assign a specific color to the event button.

Each action type is described in the following sections.

EVENT

The **Event** action type allows you to assign one or more events to an event button and then run the event/events by selecting the button. You can also reset the play list in an event so that it begins again at the first action.

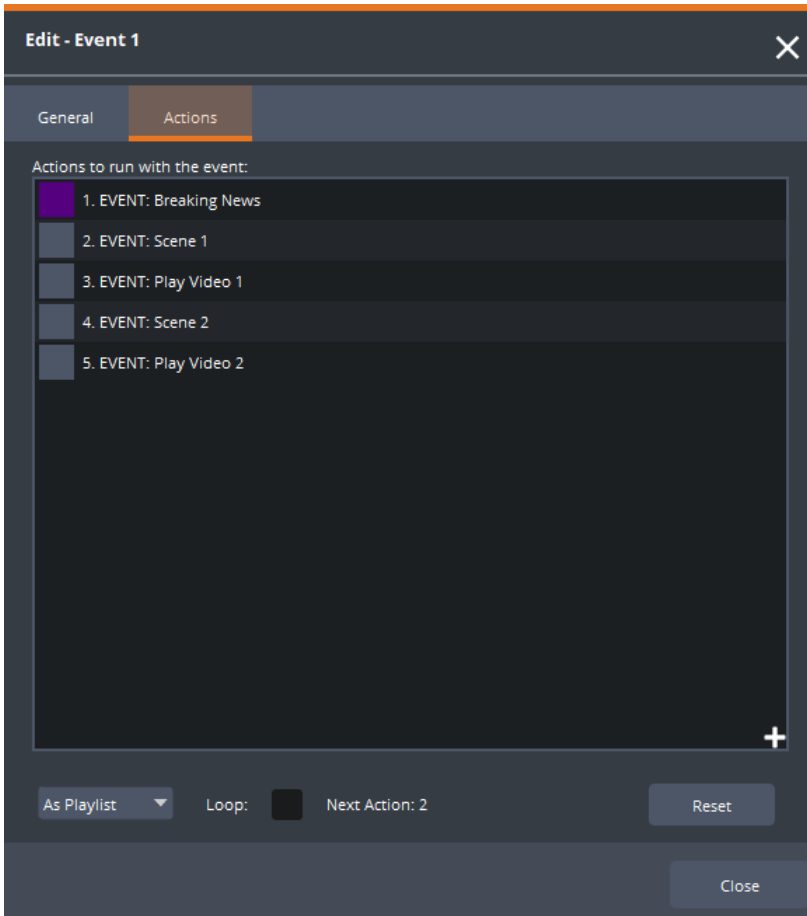

Event Action Type - Event

The **Event** action editor contains the following elements:

- **Event to Run**

This list is populated with the events that are currently defined.

You can select an event and select **OK** to add it to the actions list. In this way, you can have a single event that executes one or more of the other defined events.

- **Reset**

If the selected event has been configured to run as a playlist, this option appears, allowing you to reset the playlist in that event to the first action.

ROUTER

The **Router** action type allows you to control movies and images that have been set up in the Router panel. See Router for more information.

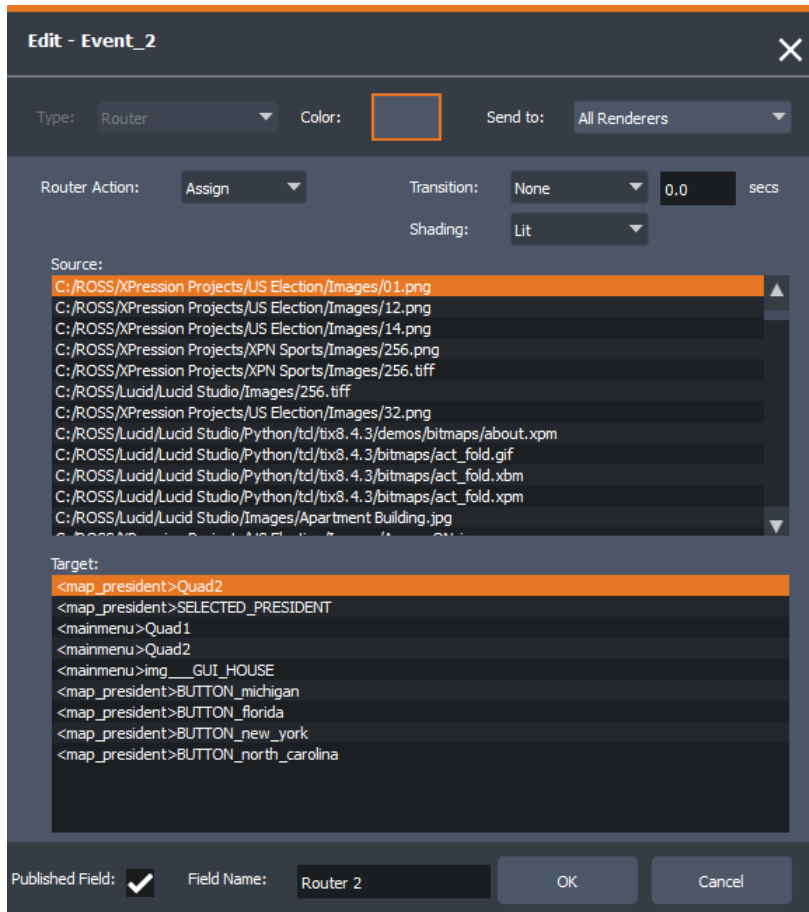

Event Action Type - Router

The **Router** action editor contains the following elements:

- **Send to**

A drop-down list from which you can choose whether to send this action to:

- **All Renderers**
- **All Tracks**
- **Track:** "name of selected track" or
- **REN:** "name of selected renderer"

- **Router Action**

Selects the type of router action to add. Depending on the option selected, the remaining elements change.

➤ **Movie:** Contains the following elements:

- **Movie List:** Displays the movies known to Lucid Studio for this project. Select the movie you want to control.
- **Movie Action:** From the drop-down, select the action you want to apply to the selected movie.

The options are **Play**, **Stop**, **To Start** and **To End**.

- **Assign:** Contains the following elements:
- **Transition:** From the drop-down, select a transition type.
 - Time:** Enter a duration (in seconds) to the transition.
- **Shading:** From the drop-down, select either **Lit** or **Unlit**.
- **Source:** Displays the sources (stills and movies) known to Lucid Studio for this project. Select the source you want to assign to a target.
- **Target:** Displays the target items known to Lucid Studio for this project. Select the target object to which you want to assign the selected source.

- **Published Field**

Indicates whether or not the field is published in a MOS event. Clear the checkbox if you don't want the field published.

★ The MOS checkbox in the [General](#) tab must also be selected for the field to be published.

- **Field Name**

The name of the field as it appears in a MOS event. You can change the name.

POSITION

The **Position** action type allows you to move items to positions that have been defined in the **Position** panel. See [To capture an item's position](#): for more information.

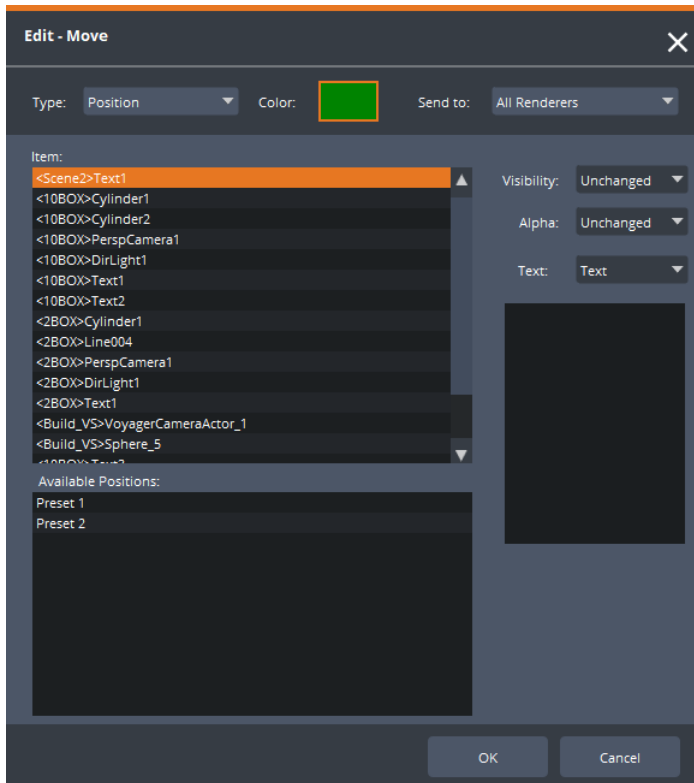

Event Action Type - Position

The **Position** action editor contains the following elements:

- **Send to**

A drop-down list from which you can choose whether to send this action to:

- **All Renderers**
- **All Tracks**
- **Track:** "name of selected track" or
- **REN:** "name of selected renderer"

- **Item**

A list of items that can be moved to another position.

- **Available Positions**

Displays the pre-defined positions for the selected item. These positions are created in the **Position** panel. The item selected in the **Item** list will start at its current position and will end at the position selected.

- **Editing Items**

As an item is selected, the options for editing the item appear to the right of the **Item** list. The options change depending on the item type and are described in the table below:

Item	Description
Object items	<p>Change the Visibility and Alpha of an object item.</p> <p>Visibility — Show or Hide the item or leave it Unchanged, when the move is complete.</p> <p>Alpha — Position the item in the Foreground or Background or remain Unchanged.</p> <p>Alpha applies to XPression objects (all) and Voyager objects (External Compositing only).</p>
Text items	<p>Change the Visibility, Alpha or content of a text item.</p> <p>Visibility — Show or Hide the item or leave it Unchanged, when the move is complete.</p> <p>Alpha — Position the text item in the Foreground or Background or remain Unchanged.</p> <p>Alpha applies to XPression objects (all) and Voyager objects (External Compositing only).</p> <p>Text — can be changed by selecting one of the following options from the Text drop-down:</p> <ul style="list-style-type: none"> • Text - Type the new text into the field below the drop-down. • CSV - Browse to a .csv file and identify the row and column from which to draw the new text. You can also change the parsing options. <p>★ Select the Table button to preview the selected CSV file as a table. Select Update to accept any changes made in the parameters.</p> <ul style="list-style-type: none"> • User Input Control - Access a Static or Global list or a DataLinq source from which to select text to add to the scene. The Static list must have been created in the corresponding text item in the Position panel. The Global list and DataLinq source are accessible regardless of where they were created. See User Input Control for more information.
Camera items	<p>Select the checkbox to set the camera as active.</p>
Light items	<p>Change the Visibility, the Color, and Intensity of a light item.</p> <p>Visibility — Show or Hide the item or leave it Unchanged, when the move is complete.</p> <p>Properties to Change — From the drop-down select whether you want to change one or all of the properties.</p> <p>Color — Select the Color icon to open a Color Selector and choose the color to be applied to the light item when the move is complete.</p> <p>Intensity — Enter a value in this field to increase or decrease the intensity of the light.</p>

FLOOR

The **Floor** action type allows you to move the virtual camera to positions that are defined in the **Floor Presets** pane of the **Track Operate** panel. See [Saving Floor Presets](#) for more information.

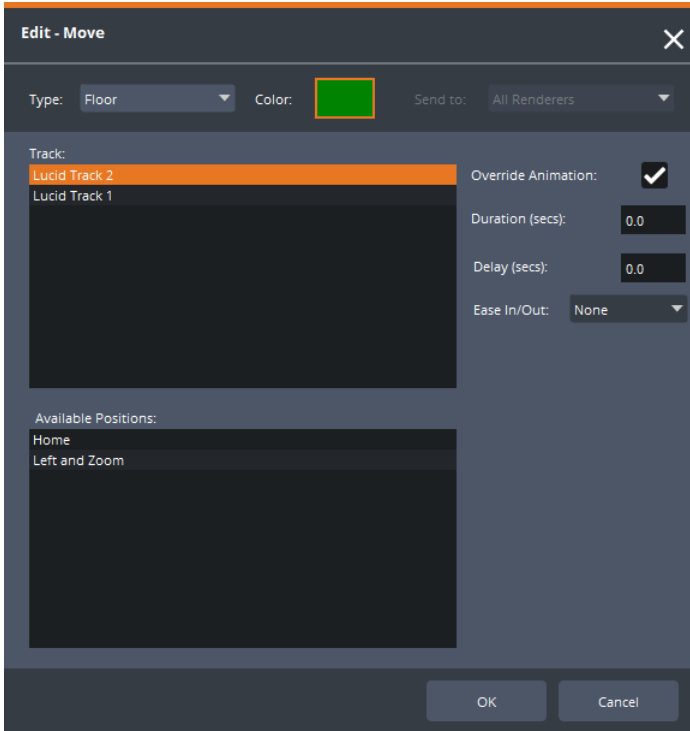

Event Action Type - Floor

The **Floor** action editor contains the following elements:

Track	A list of the connected tracks.
Available Positions	Selecting a track generates a list of the available floor positions.
Override Animation	Enabling this checkbox allows the user to change the preset Duration , Delay and Ease In/Out settings of the selected floor position.
Duration (secs)	Specifies the duration for an animated move from the camera's current position to this new position. If, for example, you enter 2.0 in this field, then whenever this position is recalled, the camera will take two seconds to get to this position from wherever it is.
Delay (secs)	Specifies a delay to be applied before the camera moves from its current position to this new position. If, for example, you enter 3.0 in this field, then whenever this position is recalled, the camera will remain in its current position for three seconds before beginning its move to this position.
Ease In/Out	Selects an easing algorithm to be used when a camera is animated from its current position to this new one. Without any easing applied, the camera will move at a consistent speed from point A to point B. This can result in animations that look somewhat abrupt at the start and end of the movement. If you apply easing, then the camera will gradually accelerate from a standstill at the start, and decelerate to a stop at the end of the animated movement.

G.MATTES

The **Garbage Mattes** action type allows you to enable or disable one or more garbage matte presets. Garbage mattes are defined in the **Track Operate** panel.

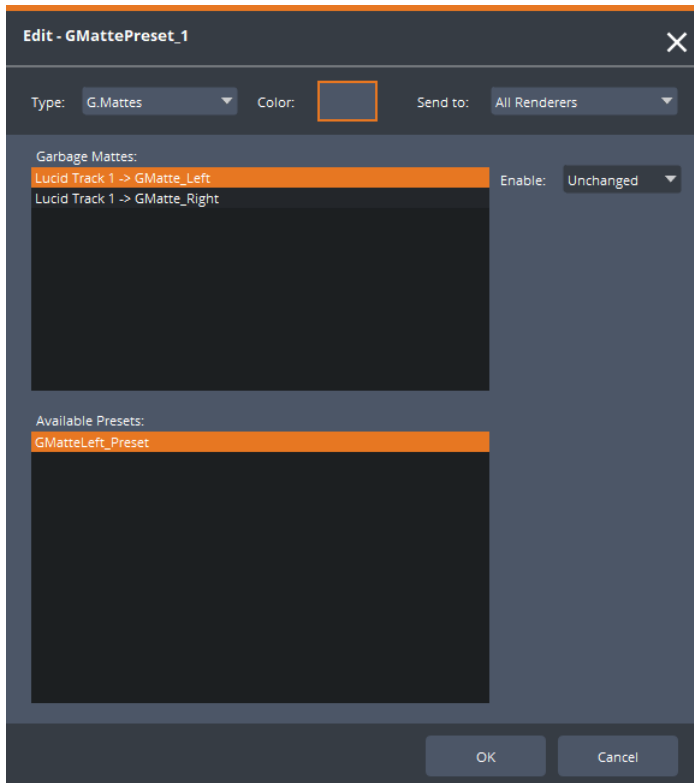

Event Action Type - Garbage Mattes

The **Garbage Mattes** action editor contains the following elements:

- **Send to**

A drop-down list from which you can choose whether to send this action to:

- All Renderers
- All Tracks
- Track: "name of selected track" or
- REN: "name of selected renderer"

- **Garbage Mattes**

After selecting a preset, use the **Garbage Mattes** list to indicate which garbage matte it refers to.

- **Available Presets**

A list of the presets that have been defined for floor positions in the **Track** panel.

- **Enable**

Use the **Enable** drop-down to select whether to leave the preset unchanged (**Unchanged**), enable the preset (**Yes**), or disable it (**No**).

ANIMATION

The **Animation** action type runs an animation that has been defined in the renderer project.

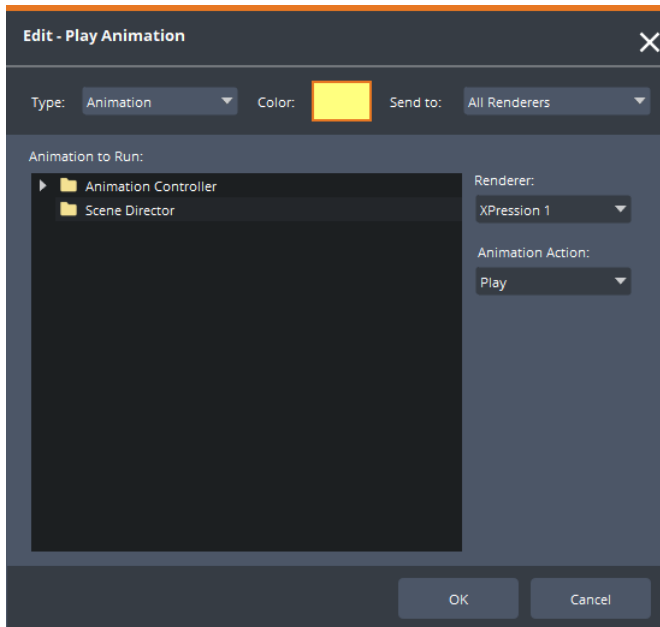

Event Action Type - Animation

The **Animation** action editor contains the following elements:

- **Send to**

A drop-down list from which you can choose whether to send this action to:

- **All Renderers**
- **All Tracks**
- **Track:** "name of selected track" or
- **REN:** "name of selected renderer"

- **Animation to Run**

A list of the available animations in the project.

- **Renderer**

Selects the rendering machine running the project.

- **Animation Action**

Selects the action to apply to the animation. Options are: **Play**, **Play Reverse**, **Play Loop**, **Play Loop Reverse**, **Play From Start** (Voyager v4.7R2 and newer), **Play From Start Loop** (Voyager v4.7R2 and newer), **Play From End** (Voyager v4.7R2 and newer), **Play From End Loop** (Voyager v4.7R2 and newer), **To Start**, **To End**, **Pause** and **Resume**, as shown below.

RENDERER

The **Renderer** action type allows the setting of specific Voyager renderer values without having to edit a logic graph.

- Your Voyager project must be playing in **PIE** mode for the logic graph to work.
- If no renderer is specified, the data will be sent to all connected renderers.
- If a renderer is selected from the **Send to** drop-down, the data will be sent to that renderer.
- The renderer values that can be set are displayed in the **Renderer Items** pane.
- The following renderer items can be edited in this event:
 - Lucid Exec
 - Lucid Float Async/Lucid Float
 - Lucid Rotator Async/Lucid Rotator
 - Lucid String Async/Lucid String
 - Lucid Vector Async/Lucid Vector
 - Send Message
 - Blueprint Functions — support for calling Blueprint functions with the following type of parameters: Boolean, Integer, Integer64, Float, Name, String, Text, Vector, Rotator and Transform. Only those functions that have been selected to be published in the Voyager Template Links window will appear.

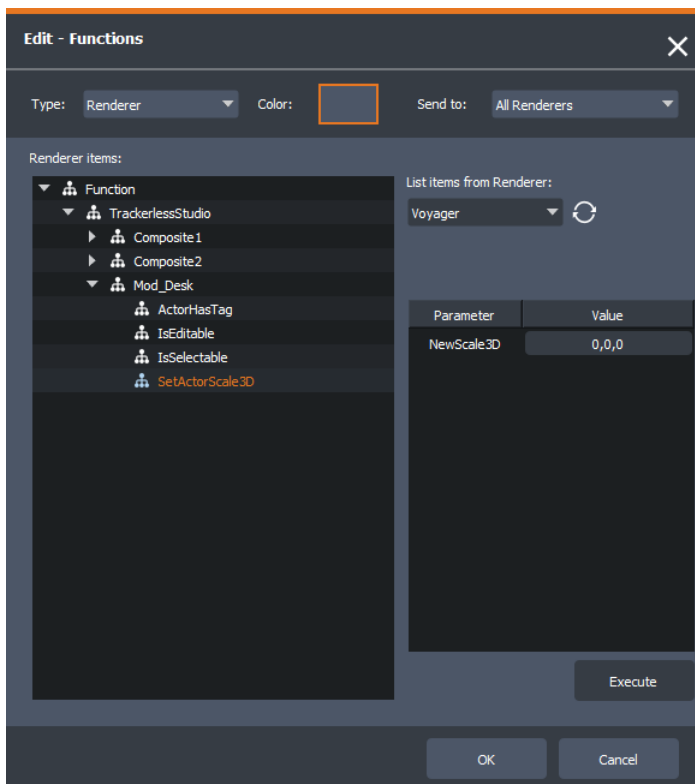

Event Action Type - Renderer

To use the Renderer action type:

1. From the **Send to** drop-down, select the renderer(s) to which you want to send the change you are making.
2. From the **List items from Renderer** drop-down, select the renderer you want to query.
3. From the **Renderer Items** list, expand the item you want to edit and select the function to be edited.
The appropriate input field(s) appears beneath the **List items from Renderer** drop-down.
4. Enter the new value in the input field(s).
5. Select **OK**.

OR

Select **Execute** to send the updated values immediately.

PAUSE

The **Pause** action type waits for a specified period of time. This can be used between other types of actions to create a pause between actions. Pauses are not executed when the actions are run in [As playlist](#) mode.

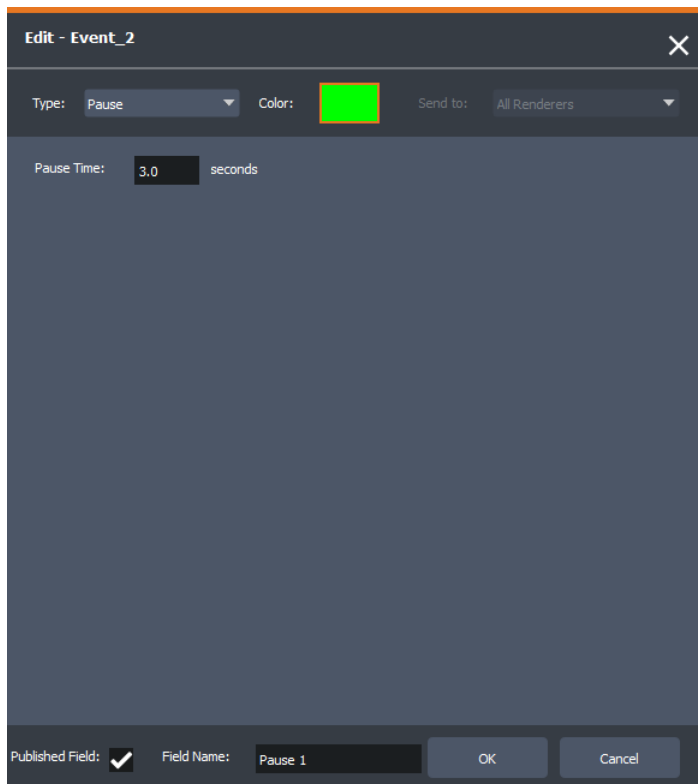

Event Action Type - Pause

The **Pause** action editor contains the following elements:

- **Pause Time**

Specifies the length of time (in seconds) that the pause should last.

- **Published Field**

Indicates whether or not the field is published in a MOS event. Clear the checkbox if you don't want the field published.

★ The MOS checkbox in the [General](#) tab must also be selected for the field to be published.

- **Field Name**

The name of the field as it appears in a MOS event. You can change the name.

SEQUENCER

The **Sequencer** action type allows you to select, take, skip or reset a sequence. Sequencer actions can only be run from one location; if a sequencer action is added to an event button, that action will not be run when running the event from a sequence. See [Panels > Sequencer](#) for more information.

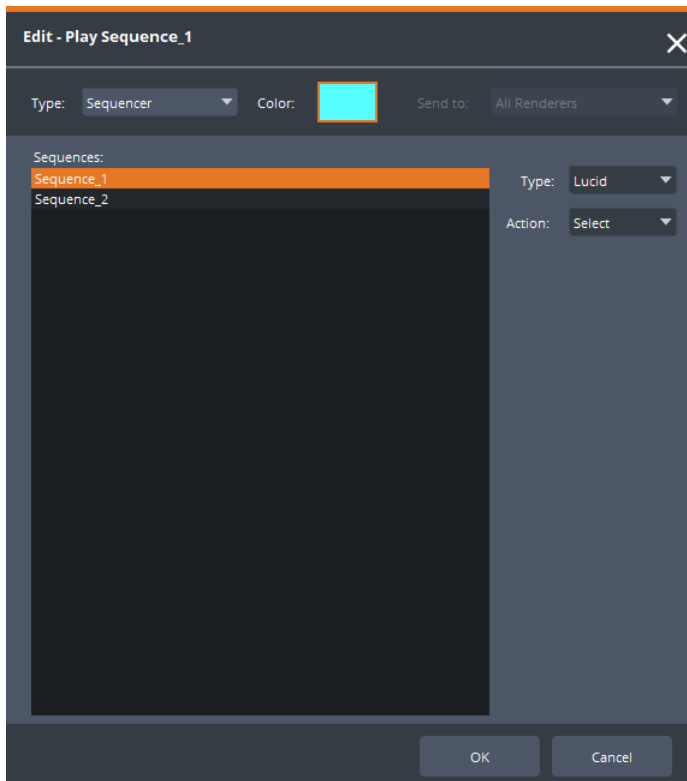

Event Action Type - Sequencer

The **Sequencer** action editor contains the following elements:

- **Sequences**

A list of the sequences that have been defined in the **Sequencer** panel. See [Panels > Sequencer](#) for more information.

- **Type**

Selects either a Lucid or MOS sequence.

- **Action**

Assigns an action to the selected sequence.

Options are:

- **Select**
- **Take**
- **Skip**
- **Reset**

LOGIC

The **Logic** action type allows you to enable a logic graph that was created in the Logic panel. See [Using Visual Logic](#) for more information.

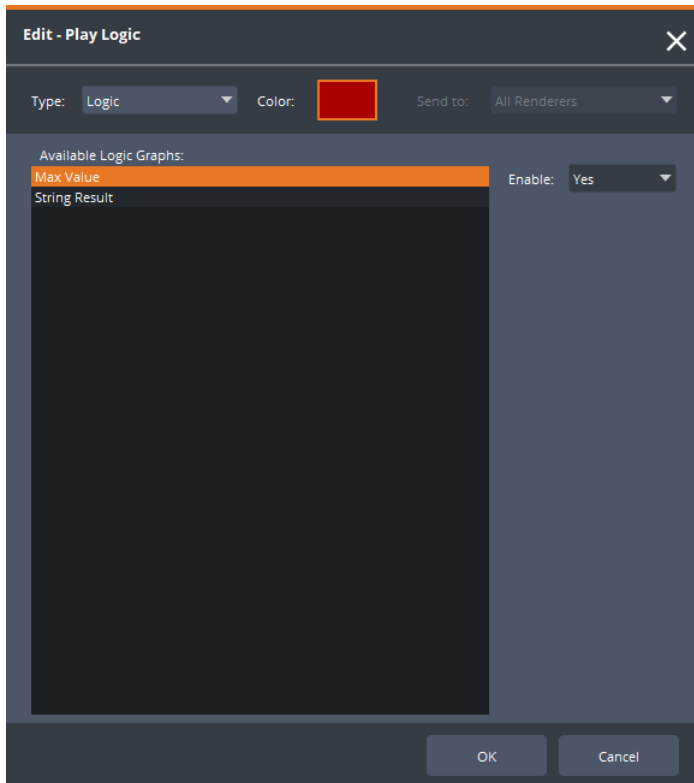

Event Action Type - Logic

The **Logic** action editor contains the following elements:

- **Available Logic Graphs**
A list of the logic graphs that have been created.
- **Enable**
Select **Yes** to enable the logic graph or **No** to disable it.

SEND

The **Send** action type sends a message through the network using the specified IP address and Port.

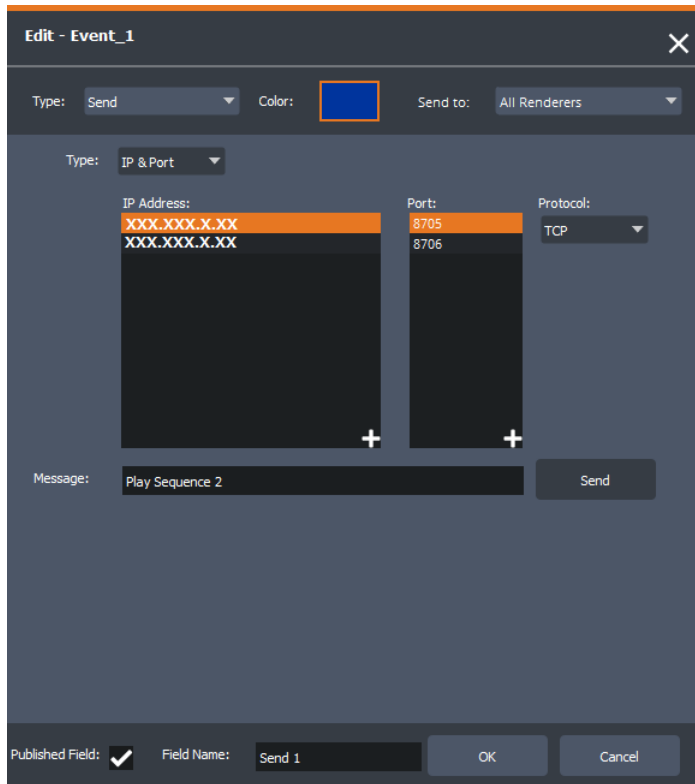

Event Action Type - Send

The **Send** action editor contains the following elements:

- **Type**

Select one of the following:

IP & Port — select the **+** icon in the lower-right corner of each list to add IP addresses and ports to which to send a message.

EndPoint — select the **EndPoint** icon  in the lower-right corner of the **EndPoints** box to open the **EndPoints** editor. If you have already created an **EndPoint** or **Preset**, you can select it from the editor. If you haven't yet created an **EndPoint**, you can create one in the editor. See [EndPoints](#) for further information.

- **Port**

A list of known ports from which to select. To add a new port, select the **+** symbol in the lower-right corner of the list. This is a required field.

- **Protocol**

Select one of three protocols: **TCP**, **UDP**, or **GPI**.

- **Message**

Select an IP address and port from the list, to which to send your message, and then type the message you want to send.

- **Send**

To test that the message is being sent correctly, select **Send**.

- **Published Field**

Indicates whether or not the field is published in a MOS event. Clear the checkbox if you don't want the field published.

★ The MOS checkbox in the [General](#) tab must also be selected for the field to be published.

- **Field Name**

The name of the field as it appears in a MOS event. You can change the name.

ROBOTICS

The **Robotics** action type allows users to select camera head positions that have been captured by Ross's **SmartShell Control System** software. Note that Furio also has moves stored as **Pre-saved Positions**.

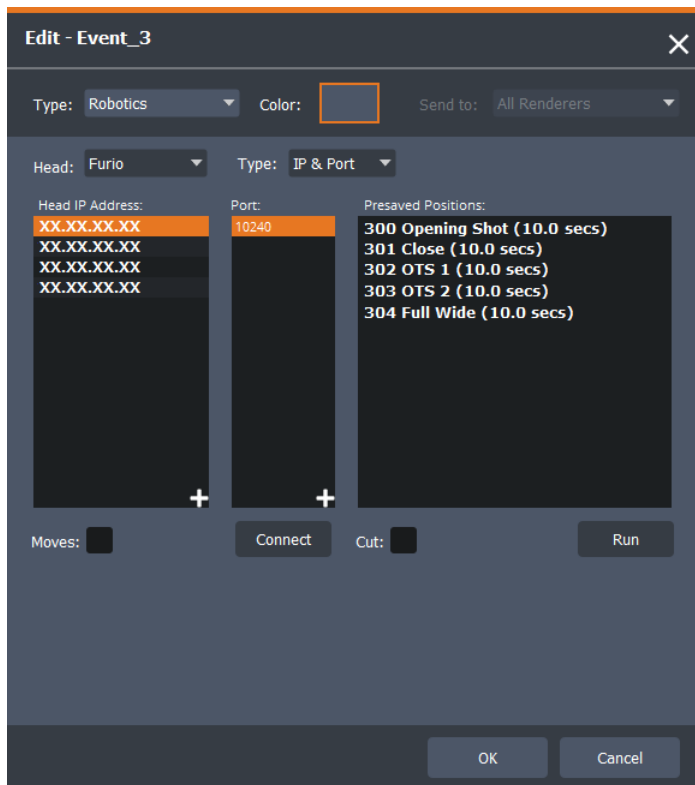

Event Action Type - Robotics

The **Robotics** action editor contains the following elements:

- **Head**

Selects the type of camera head for which you want to set a presaved position. Options are **Furio** and **Cambot**.

- **Type**

IP & Port — select the **+** icon in the lower-right corner of each list to add the IP addresses and ports of the camera heads.

EndPoint — select the **EndPoint** icon  in the lower-right corner of the **EndPoints** box to open the **EndPoints** editor. If you have already created an **EndPoint** or **Preset**, you can select it from the editor. If you haven't yet created an **EndPoint**, you can create one in the editor. See [EndPoints](#) for further information.

- **Head IP Address/Robotics Server IP**

The IP address of the Furio (Head IP Address) or CamBot (Robotics Server IP). This is a required field.

- **Port**

The port number of the head. This is a required field.

- **Presaved Positions**

Positions captured and stored by the SmartShell Control System. A list of the stored positions is generated when the **Connect** button is selected.

- **Moves**

When checked, enables stored moves to be selected. Moves are a sequence of presaved positions.

- **Connect**

After selecting the IP address and port, selecting **Connect** generates a list of the stored positions in the **Presaved** positions pane. If **Moves** is checked, these will also be displayed.

- **Cut**

- Executes an action as quickly as the robot axes configuration allows, regardless of any duration defined in the presaved position. When **Moves** is selected, **Cut** is a cue. Furio moves must first be cued.

- **Run**

- Executes an action at the speed defined in the **Preset**.

CHROMA

The **Chroma** action type allows you to apply a chroma key preset to the selected composite plane.

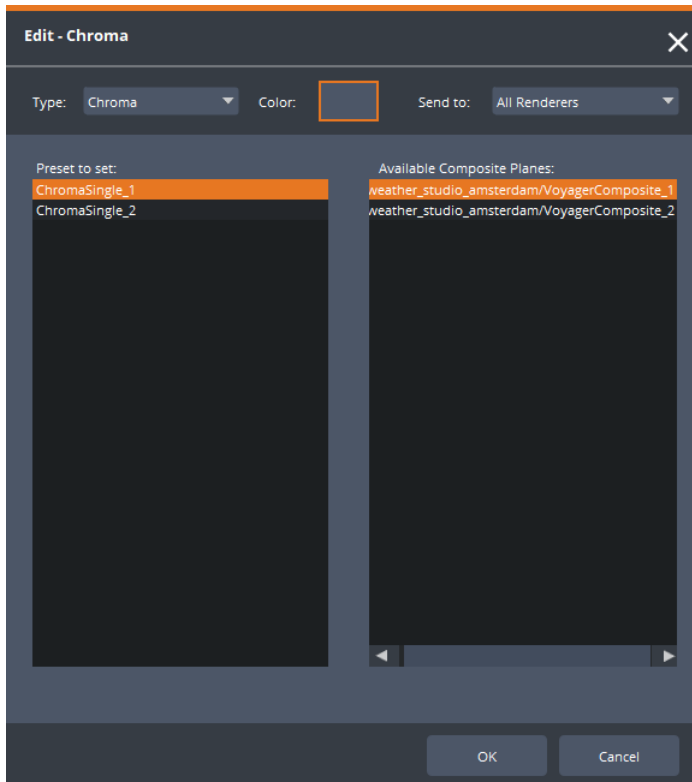

Event Action Type - Chroma

The **Chroma** action editor contains the following elements:

- **Preset to set**

Lists the presets configured in [Panels > Chroma](#).

- **Available Composite Planes**

Lists the composite planes available in the project to which you can apply the selected preset.

To apply a chroma key preset to a composite plane:

1. Select the preset you want to use and then select the composite plane to which you want to apply the preset.
2. Then select **OK**.

COLOR CORRECTION

The **Color Correction** action type allows you to assign preset color corrections or no correction to the selected camera feed.

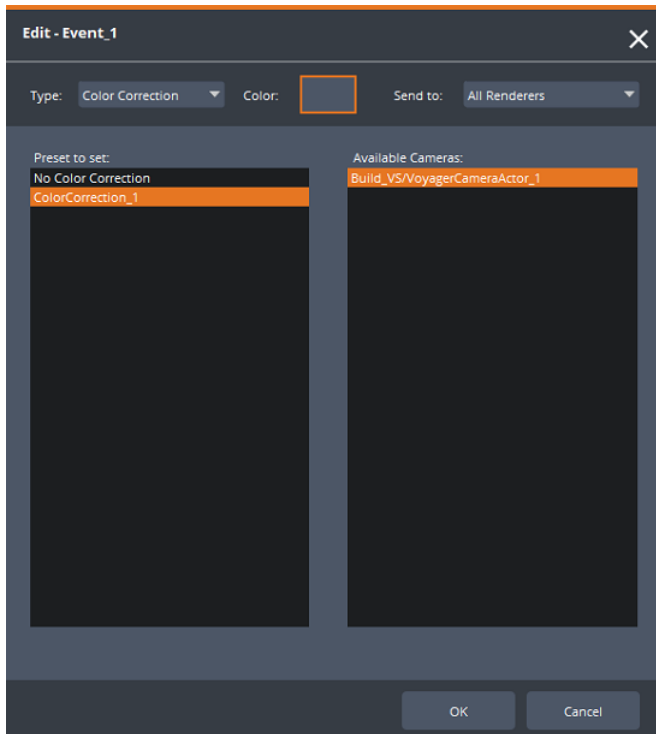

Event Action Type - Color Correction

The **Color Correction** action editor contains the following elements:

- **Preset to set**

Lists the preset color corrections that have been created as well as the **No Color Correction** option.

- **Available Cameras**

Lists the connected cameras to which the color correction preset can be applied.

To assign a preset color correction to a camera:

1. Select the preset and then select the camera to which you want to apply the preset.
2. Then select **OK**.

VIDEO WALLS

The **Video Walls** action type allows you to assign presets to a Brompton controller.

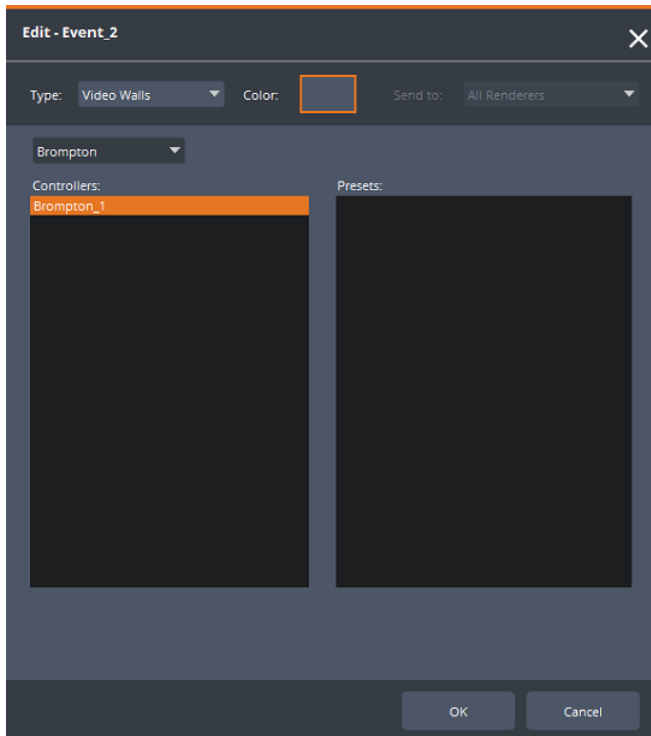

Event Action Type - Video Walls

The **Video Walls** action editor contains the following elements:

- **Controllers**

Lists the controllers supported by Lucid Studio.

- **Presets**

Lists the presets that have been set up in the controller.

To assign a preset to a Brompton controller:

1. Select the controller and then select the preset you want to use.
2. Then select **OK**.

SCRIPT

The **Script** action type allows advanced users to run an external Python script, that could be doing anything inside or outside of Lucid Studio.

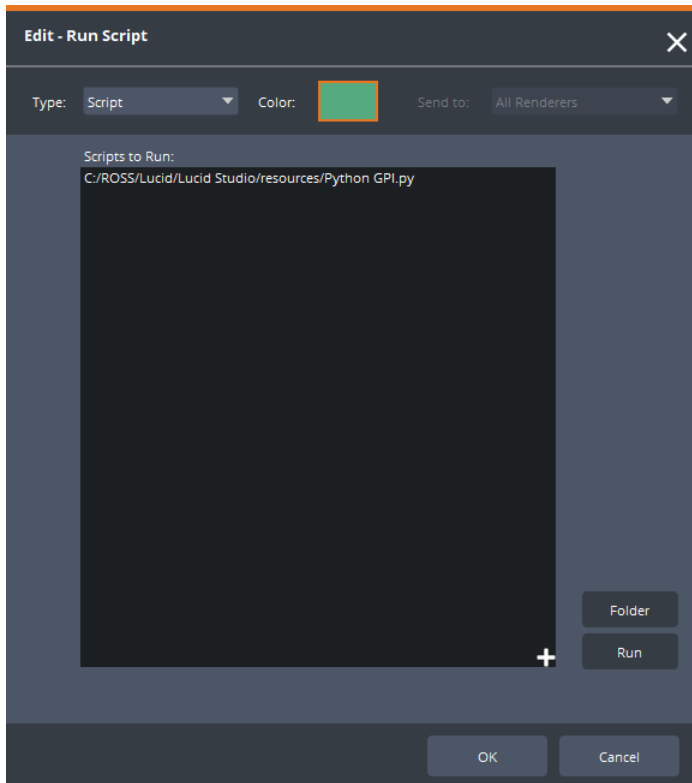

Event ActionType - Script

The **Script** action editor contains the following elements:

- **Scripts to Run**

Creates a list of scripts that can be selected and run.

To add a script, select the **+** symbol in the bottom-right corner of the pane.

- **Folder**

This button is activated when a script is added to the **Scripts to run** list. Select a script and then select **Folder** to open the folder containing the selected script, for editing purposes. The edited script is then available in the list.

- **Run**

To test that the script is running correctly, select **Run**.

MISC

The **Misc** action type allows you to run commands for a variety of actions that don't fit into any of the other event types.

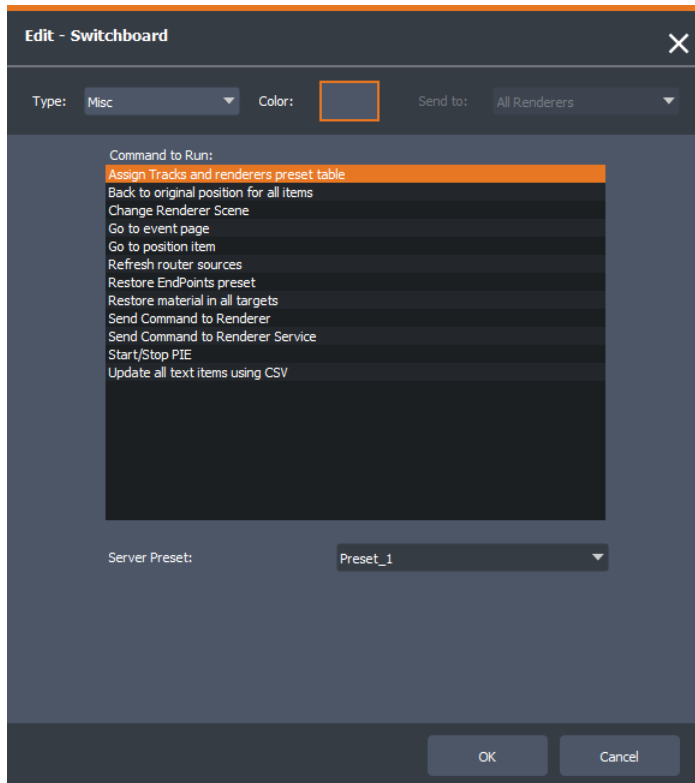

Event Action Type - Misc

The **Misc** action editor contains the following commands:

- **Assign Tracks and renderers preset table**
Selects a Lucid Track/Renderer preset that has been defined in the [Server](#) panel, in the **Server** tab.
- **Back to original position for all items**
Sets the original position for each item in the Position panel (does not apply to the light color property).
- **Change Renderer Scene**
Allows you to change the current scene for any renderer.
Select the renderer, then the scene and select **OK**.
- **Go to event page**
Goes to the event page selected in the **Events Page** drop-down.
- **Go to position item**
Goes to the page in the **Position** panel of the item selected in **the Position Item** drop-down.
- **Refresh router sources**
Reloads the source

- **Restore EndPoints preset**

When selected, **Server Preset** changes to **EndPoints Preset**. You can then restore the **EndPoint** selected from the **EndPoints Preset** drop-down. See [EndPoints](#) for further information.

- **Restore material in all targets**

Sets the original material for each target in the **Router** panel,

If you get error messages from Lucid Studio and Windows, it means that a target(s) was originally created with no material applied, so there is nothing to be restored.

- **Send Command to Renderer**

Sends one of the following commands to the selected renderer or to all renderers:

- **Clear Stats** (Voyager and XPression renderers)
- **Media Stats** (Voyager renderers only)
- **Performance Stats** (Voyager and XPression renderers)
- **Custom** (Voyager renderer only) - when selected, the **Custom Command** field becomes active and you can enter a command.

Select the **Send** button to send the command immediately or select close to save it as an event. Then you can send the command from the event button.

The selected stats will be displayed on the screen in **PIE** mode in Voyager and in the **Virtual Output** window in XPression (provided the **Use Lucid Overlay Information Scene** checkbox is selected in Lucid Driver for XPression). See [Lucid Driver for XPression > XPression](#) for more information.

- **Send Command to Renderer Service**

Allows you to select a **Renderer Service** and start or stop a project from it in one or all services.

- **Start/Stop PIE**

Allows you to start or stop playing the project in the editor window of a Voyager renderer (applies to Voyager versions 4.27 and newer).

To start/stop playing in the editor:

- Select the renderer (or **Apply to all Renderers**) and then select whether to start or stop playing the project.

- **Update all text items using CSV**

Updates text items using CSV; use when the **Never Update** option has been selected to trigger an update.

Sequencer

You can use the **Sequencer** panel to run a sequence of Lucid events or MOS stories. The original Lucid event is created in the Events panel. The MOS stories are created in a Newsroom Control System (NCS).

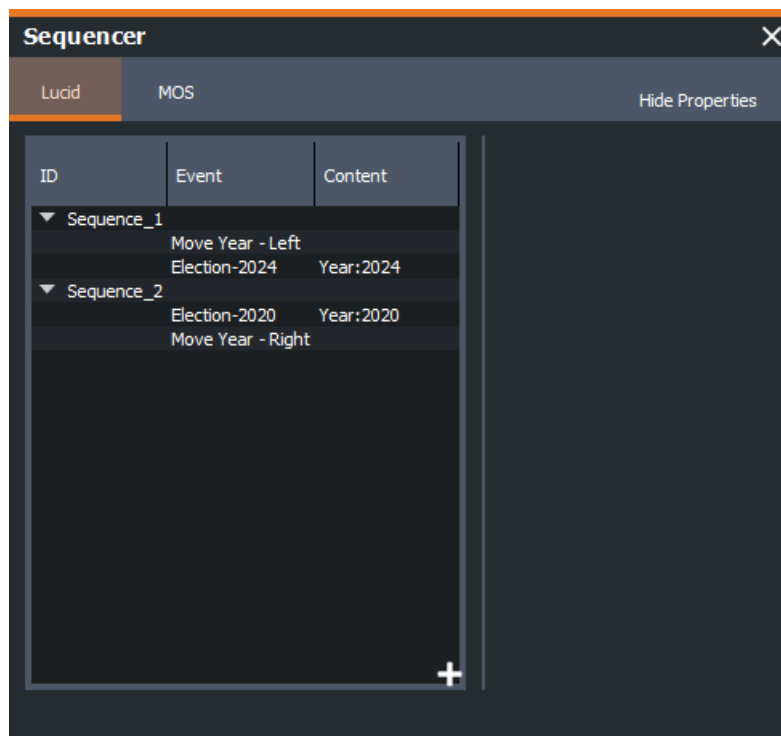

Sequencer Panel

Once added to a sequence, you can play or modify the events or stories without affecting the originals. You can play a MOS story in a Lucid Sequence and a Lucid event in a MOS sequence.

For further information see:

[Lucid Event Sequences](#)

[MOS Story Sequences](#)

Lucid Event Sequences

The following section provides instructions for creating, playing and modifying a sequence of Lucid events.

★ Events in the **Sequencer** panel are not automatically updated if you add, remove or change the order of actions in a source event. If the event in the **Sequencer** is different from the source event, you will see a red exclamation mark to the left of the event. See [To update the events in a Lucid sequence](#): for further information.

To create a Lucid event sequence:

1. In the **Sequencer** panel, select the **Lucid** tab and select **Hide Properties** to expand the **Sequences** pane.
2. Select in the **Sequences** pane, and then select the **+** symbol in the bottom-right corner.

The **New Sequence** window opens.

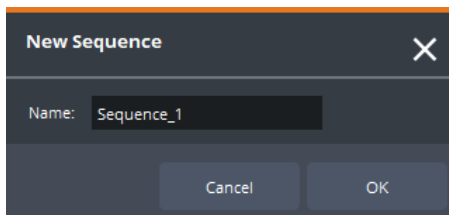

Sequencer - Add New Sequence

Alternatively, you can right-click in the empty space in the **Sequences** pane and select **New Sequence**.

3. Enter a name for the new sequence and select **OK**.
4. In the **Lucid** tab, select the sequence and select the **+** icon in the bottom-right corner.

OR

Right-click on the sequence and from the context menu, select **Append Event**.

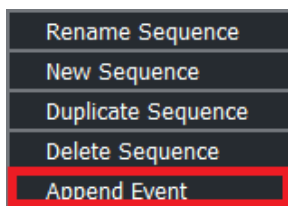

Sequencer - Append Event

5. From the **Append Event** list, select the Lucid event you want to add to the sequence.

Alternatively, you can enter the name of the event in the **Search** field.

Only add events that are set to run as **All Actions**. Events set to run as **As Playlist** will not work correctly in the sequencer. See [All actions](#) for more information.

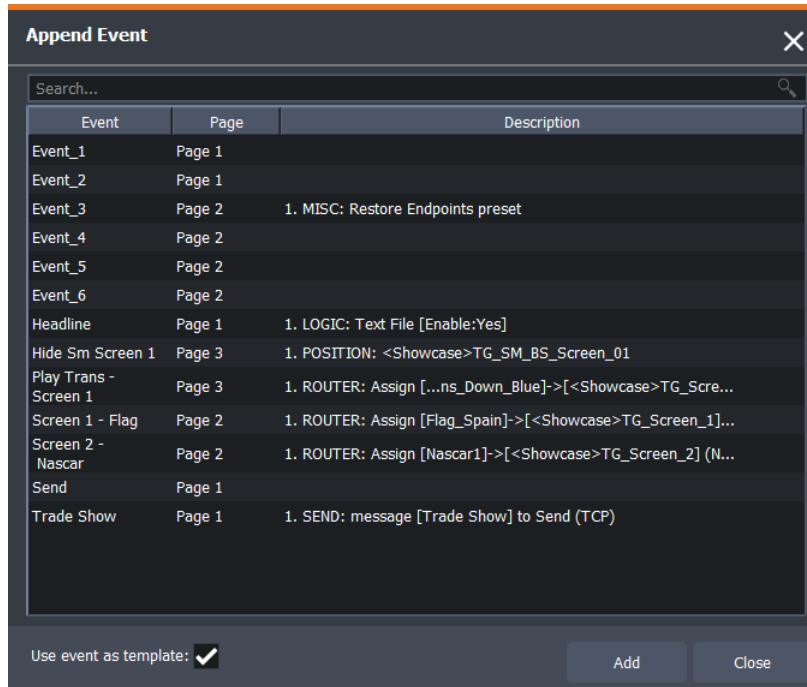

Sequencer - Append Event List

6. Select **Add**.

Alternatively, you can double-click on an event to add it but keep the event list open, so that you can continue adding events.

7. Repeat Steps 4 to 6 to add more Lucid events to the sequence.

8. Select an event and drag it to move it to a new position in the sequence or to another sequence.

To rename a sequence:

1. In the **Sequencer** panel, with the Lucid tab selected, right-click on a sequence in the **Sequences** list.

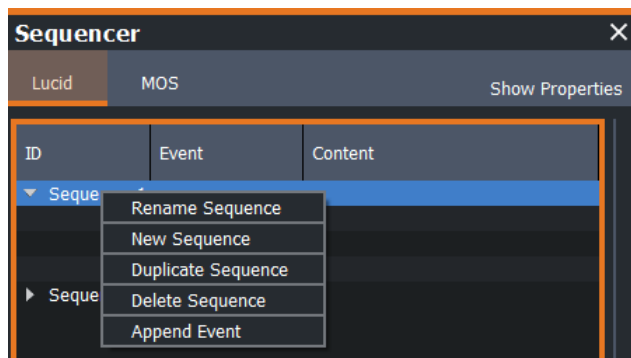

Sequencer - Context Menu

2. From the context menu, select **Rename Sequence**.
3. In the **Rename Sequence** window, enter a new name for the sequence and select **OK**.

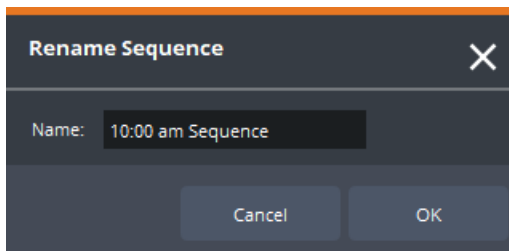

Sequencer - Rename Sequence

To modify a Sequencer event:

1. In the **Sequencer** panel, with the **Lucid** tab selected, select a sequence in the list of **Sequences**.

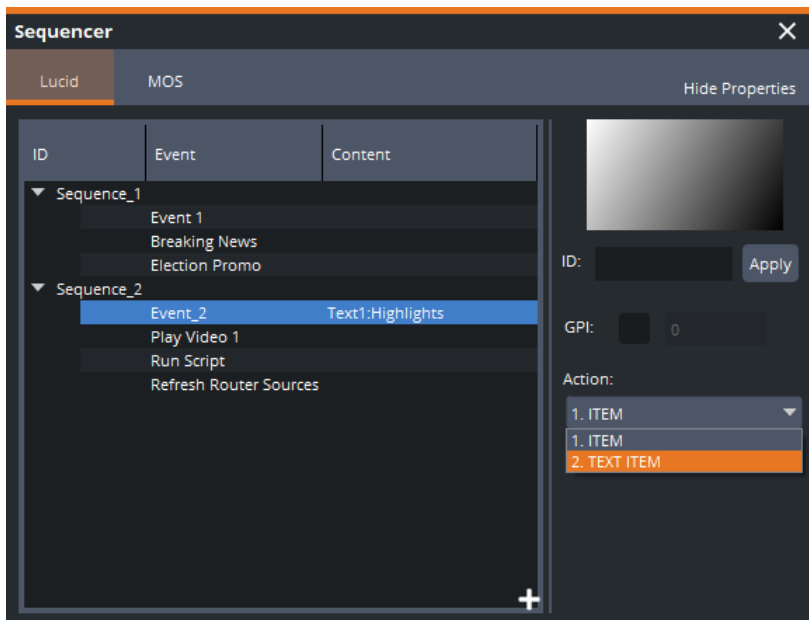

Sequencer - Editing Sequencer Events

2. In the **Events** column, select an event to modify.
3. Then select **Show Properties**.
A second panel opens to the right of the sequences, showing the parameters that can be modified.

- From the **Action** drop-down in the **Properties** panel, select the action to modify.

The **Action** drop-down contains all the actions created for the selected event. If the selected event contains a **Thumbnail** image, this image appears above the **Action** drop-down.

The possible modifications are listed in the following table:

Action	Modifications
ROUTER	<p>Resource path: Select the Browse button to navigate to a new image.</p> <p>Seconds: Enter the amount of time you want the image to take to fade in. A value of 0.00 will make the image cut in rather than fade.</p>
ITEM	Indicates a video clip or still image.
TEXT ITEM	<p>Text Drop-down: The Text drop-down appears when there is a text item in the selected event. It contains 2 options, Text and User Input Control.</p> <p>To replace text:</p> <ol style="list-style-type: none"> From the Text drop-down, select the Text option. In the Text lines pane, select the text you want to replace and enter the new text. <p>To delete text:</p> <ol style="list-style-type: none"> From the Text drop-down, select the Text option. In the Text lines pane, select the text you want to delete and press the Delete key. <p>To use the user input controls:</p> <ol style="list-style-type: none"> From the Text drop-down, select the User Input Control option. From the List Type drop-down, select Static List, Global List, or DataLinq. From the list or drop-down, select the text you want to use. The Static list must have been created in the corresponding text item in the Position panel. The Global list and DataLinq source are accessible regardless of where they were created. See User Input Control for more information. <p>To edit a Global List:</p> <ol style="list-style-type: none"> From the List Type drop-down, select Global List. Select the Options button  beside the List drop-down. In the User Input Control - Global Lists window, from the Global Lists pane, select the list you want to edit. The list is displayed in the Label/Value pane. Right-click the list item you want to edit and from the menu, select Edit. In the Edit - User Input Control dialog, edit the Label and/or Value and select OK. Select Close to exit the User Input Control - Global Lists window.

Action	Modifications
	<p>The list is updated with the new information.</p> <p>To edit a DataLinq source:</p> <ol style="list-style-type: none"> From the List Type drop-down, select DataLinq. <p>The currently configured DataLinq source description is displayed below the List drop-down.</p> <ol style="list-style-type: none"> Select the Edit button. In the Edit DataLinq Configuration window, use the drop-downs to edit the DataLinq source details, or select Browse to open the Table view and edit the Column Label and Value only. When finished editing, select OK. <p>The DataLinq source description is updated with the new information, which can now be selected from the drop-down.</p>
PAUSE	<p>Seconds:</p> <p>Enter the duration of the pause.</p>

To play a Lucid sequence:

- In the **Sequencer** panel, in the Lucid tab, expand the sequence to play.

An orange frame around the pane indicates that the sequence is ready to play.

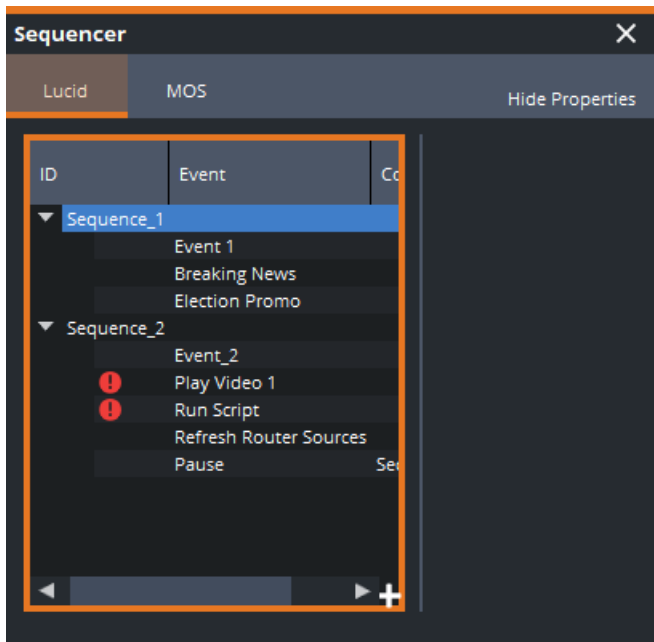

Sequencer - Play Lucid Sequence

- Double-click the event you want to play to trigger it.

The event name turns orange to indicate that it is being played.

- Double-click the next event.

Alternatively, you can press the **Space** bar or the **+** key on the number pad to play the event and automatically advance to the next event.

To update the events in a Lucid sequence:

1. Right-click on an event that has a red exclamation mark beside it.

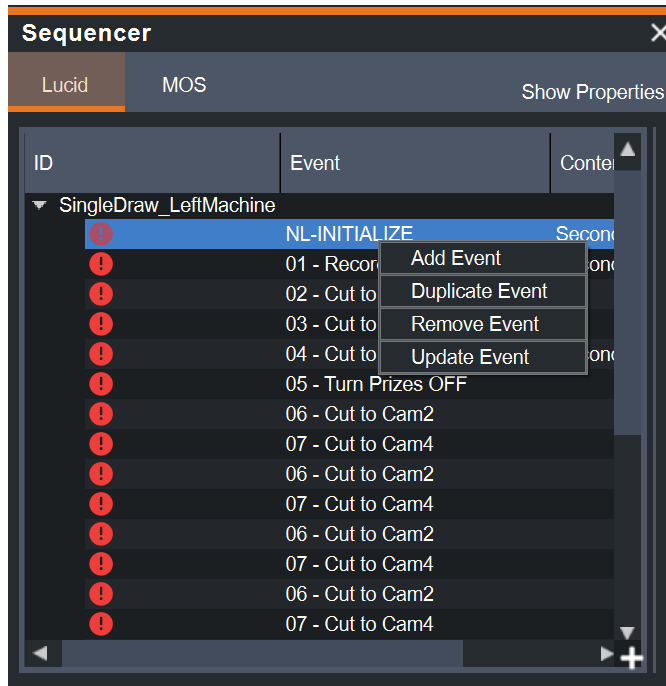

Sequencer - Update Event

2. Select **Update Event**.

The source event will be copied to the sequence. If any field has been changed in the **Sequencer**, the value will be lost and the value from the source event will be used.

Alternatively, you can select an empty area of the **Sequencer** panel and select **Update All Mismatched Events** to update multiple events.

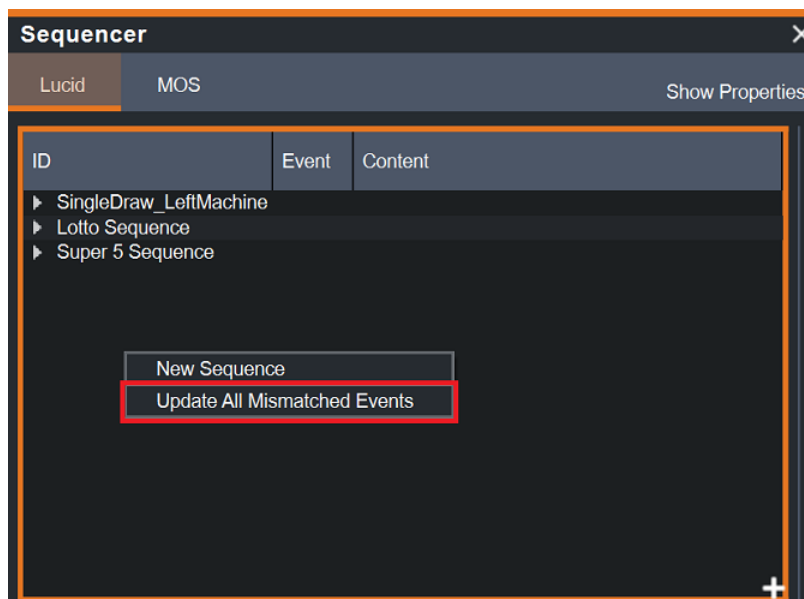

Sequencer - Update All Mismatched Events

3. In the **Confirmation** dialog that opens select **OK**.

To remove an event from a Lucid sequence:

1. In the **Sequencer** panel, in the **Lucid** tab, expand the sequence that contains the event you want to remove.
2. In the **Event List** panel, select the event you want to remove.
3. Right-click and from the context menu, select **Remove Event**.
4. In the **Confirmation** dialog, select **OK**.

To delete a Lucid sequence:

1. In the **Sequencer** panel, in the **Lucid** tab, from the **Sequences** list, select the sequence you want to delete.
2. Right-click and from the context menu, select **Delete Sequence**.
3. In the **Confirmation** dialog, select **OK**.

To find an event in a Lucid sequence:

1. Make sure both the **Events** panel and the **Sequencer** panel are open in the layout.
2. In the **Sequencer** panel, in the **Lucid** tab, expand a sequence, right-click an event and select **Go to Event**.

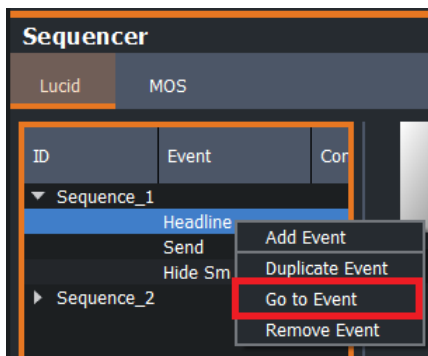

Sequencer - Go to Event

In the **Events** panel, the focus will go to the page containing the event and the event button will flash briefly.

MOS Story Sequences

MOS story sequences are generated by the NCS (Newsroom Control System) being used and appear in the MOS sequence panel automatically, when Lucid Studio has been configured to communicate with the NCS through the XPression Gateway.

For information about setting up the communication between the NCS and the XPression Gateway, see [XPression Gateway Setup](#).

The following section provides instructions for creating and playing a sequence of MOS events. MOS events and sequences are edited or deleted in the NCS.

To create a MOS sequence:

1. In the **NCS**, create a story.
2. In the **NCS**, in the **MOS Plugin**, select the **Lucid** tab.

The MOS-enabled Lucid events that have been created in Lucid Studio will appear in the **Lucid** tab.

For information about enabling MOS for an event, see [Lucid MOS Service > Exploring the Lucid MOS Service Interface > MOS](#).

3. Add MOS-enabled Lucid events to the story.
4. Save and publish the story.

In the **Sequencer** panel, in the **MOS** tab, the story and the MOS-enabled Lucid events are displayed. If there are no MOS-enabled Lucid events in the story, the **Event** panel will be empty.

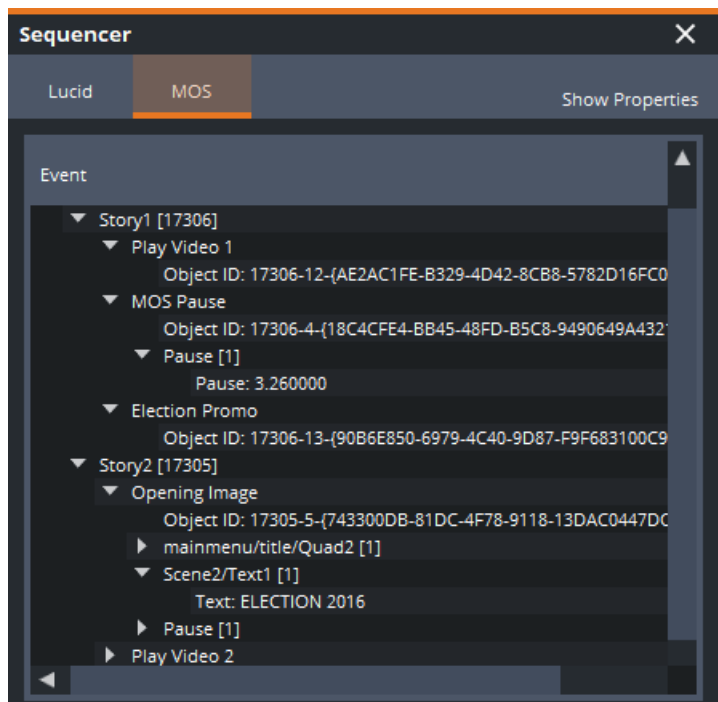

Sequencer Panel - MOS Tab

To play a MOS sequence:

1. In the **Sequencer** panel, select the **MOS** tab.
2. Then select the sequence list.

An orange frame is displayed around the list, indicating that it has focus.

3. Select the first event and then press the **Space** bar or the **+** key to play each event in the order in which they are listed.

To view MOS event properties:

1. With the MOS tab selected, select **Show Properties**.

The **Properties** panel opens.

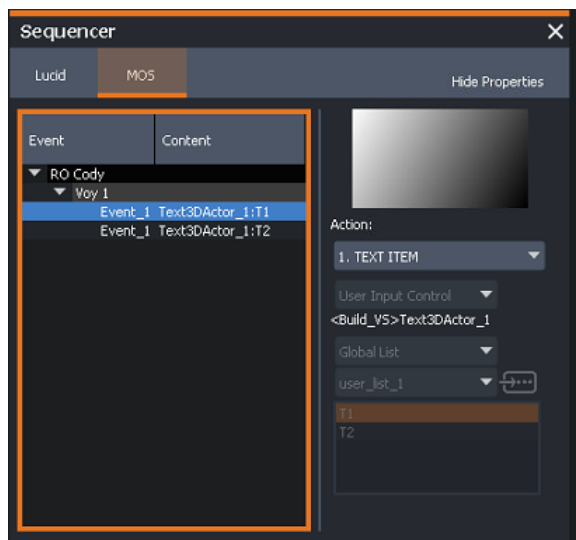

Sequencer - MOS Properties

The possible read-only properties are listed in the following table:

Action	Modifications
ROUTER	Resource path: Shows the path to the currently selected image. Seconds: Indicates the amount of time the image will take to fade in.
ITEM	Indicates a video clip or still image.
TEXT ITEM	Text Drop-down: The Text drop-down appears when there is a text item in the selected event. It contains 2 options, Text and User Input Control . If Text has been selected, the pane will show the text currently contained in the event. If User Input Control has been selected, the pane will show the name of the list, whether it is a Static List, Global list, or DataLinq, and which item in the list is selected for that event.
PAUSE	Seconds: Indicates the duration of the pause.

To find an event in a MOS sequence:

1. Make sure both the **Events** panel and the **Sequencer** panel are open in the layout.
2. In the **Sequencer** panel, in the MOS tab, right-click an event and select **Go to Event**.

In the **Events** panel, the focus will go to the page containing the event and the event button will flash briefly.

Router

The **Router** panel can be used to place still images, materials, and videos on objects within any renderer, without having to further interact with the renderer UI. This is done by assigning a Source or Material to a Target.

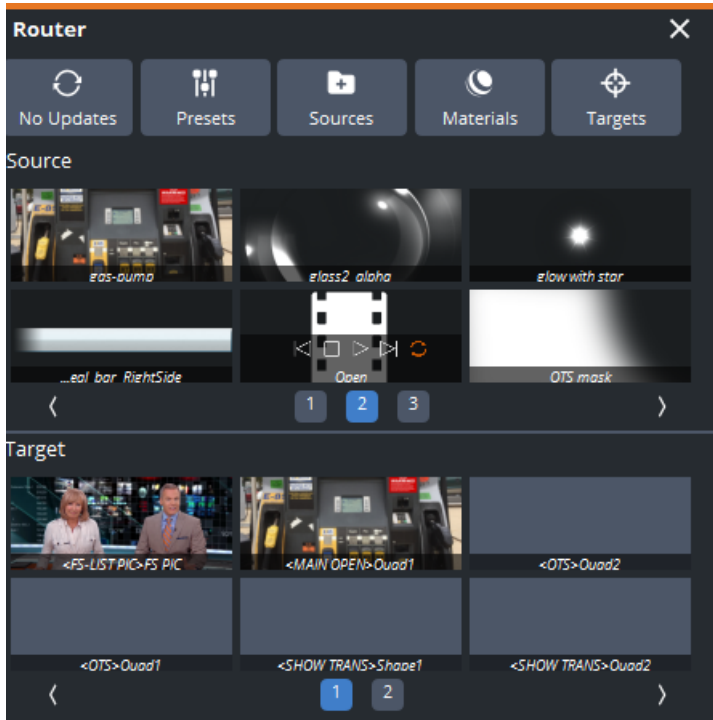

Router Panel

This section contains the following topics:

[Sources](#)

[Materials](#)

[Targets](#)

[Presets](#)

[Groups](#)

[No Updates/Updates](#)

Sources

Sources are images, materials and videos usually located on a network. You can also add sources directly from a Streamline server.

This section describes the following procedures:

[To add sources from a network:](#)

[To delete network sources:](#)

[To add sources from Streamline:](#)

[To reload or delete Streamline sources:](#)

To add sources from a network:

1. Select the **Sources** button.

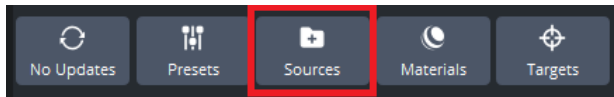

Router - Add Sources from a Network

The **Router Sources** window opens.

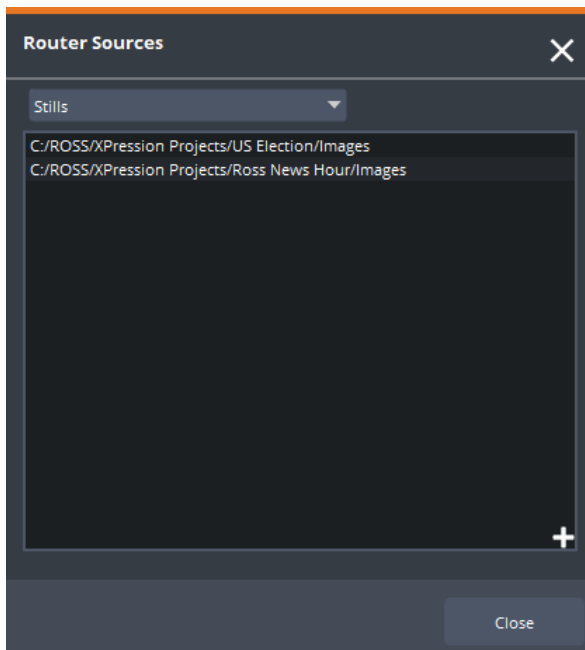

Router - Router Sources

2. In the **Router Sources** window, from the drop-down, select one of the following source types:

- **Stills**
- **Movies**
- **Movie Thumbnails**

Movies do not auto-generate thumbnails within Lucid Studio, so users can import stills from a folder with images and names of respective movies. Thumbnails must have the same file name (with an image file extension) as the movie file they are referencing.

- **Material Thumbnails**

Materials also do not auto-generate thumbnails within Lucid Studio. Thumbnails must have the same file name (with an image file extension) as the material file they are referencing.

3. Select the **+** sign in the bottom-right corner to open a file browser window.
4. Navigate to the folder containing the selected source (typically on the X: drive) and select **Select Folder**.

The path appears in the pane beneath the drop-down.

5. Select **Close** to exit the window.

All the sources contained in the selected folder appear in the **Source** section of the **Router** panel.

To delete network sources:

1. Select the **Sources** button.
2. In the **Router Sources** window, from the drop-down, select the source type you want to delete.
3. Right-click the path to the source you want to delete and select **Delete**.

To add sources from Streamline:

1. Open **Streamline** in the **Web** panel.
2. Select on an asset in **Streamline** and drag it to an empty **Source** slot in the **Router** panel.

To reload or delete Streamline sources:

1. Select the **Web** icon  in the upper-right corner of the **Streamline** source thumbnail.
2. From the menu, select **Reload** to refresh the source or **Delete** to remove the source from the **Router** panel.

Materials

Materials are texture, colors, effects, etc (XPression) applied to an object or live video inputs (Voyager).

★ When using Voyager in **Game** mode, materials that haven't been assigned to an object will not be available in Lucid. It is best practice to create a few objects that are positioned beneath the floor in the scene, and assign all the materials you want to be able to access in the router to those objects, creating a "material library" for Lucid.

This section describes the following procedures:

[To add materials](#)

[To delete materials](#)

To add materials:

1. Select the **Materials** button.

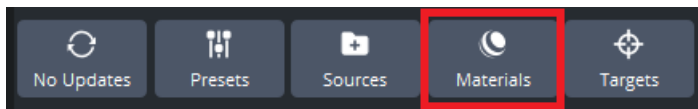

Add Sources From Project Materials

2. In the **Materials** window, from the **Renderer** drop-down, select your renderer.

Any available materials in that renderer will populate the **Project Materials** field box.

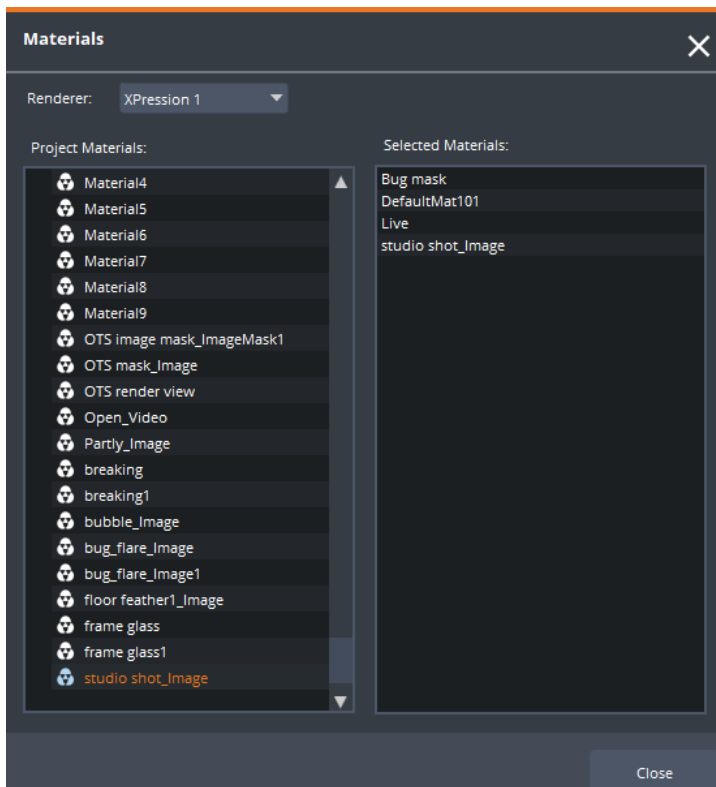

Router - Project Materials

3. Double-click a material in the **Project Materials** field box to move it to the **Selected Materials** field box.
4. Select **Close** to exit the window.

To delete materials:

1. Select the **Materials** button.
2. In the **Materials** window, in the **Selected Materials** pane, right-click the material you want to delete and select **Delete**.

Targets

Targets are objects in the project on which the Router sources will be applied. They can be added to the Router panel to make them easily accessible and manageable. You can change the material that is applied to the target, select whether the material will be lit or not, select the transition mode in which the material is applied and how long it takes for the new material to be applied.

This section describes the following procedures:

[To add targets](#)

[To add a source material to a target](#)

[To edit a target](#)

[To delete a target](#)

[To restore a target](#)

To add targets:

1. Select the **Targets** button.

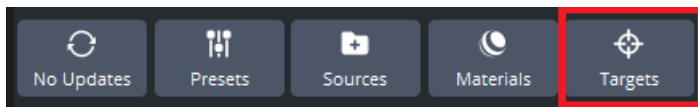

Router - Add Target Button

2. The **Router Targets** pane opens.

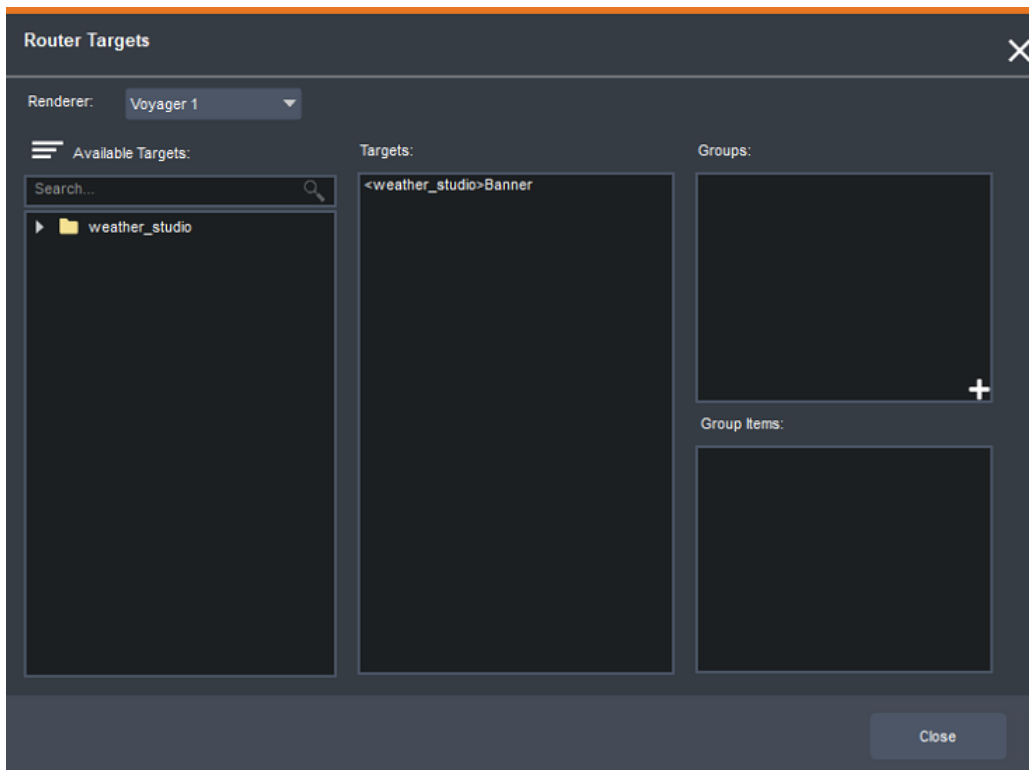

Router Targets Pane

3. From the **Renderer** drop-down, select the renderer from which you want to add targets.

The scene folders in the project will populate the **Available Targets** field box.

4. Select the **List** icon to the left of the **Available Targets** label to select how you want to view the items, either in a hierarchical tree format or in a flattened tree, with each item listed alphabetically within the scene folder.
5. Select the arrow beside a scene folder to open it and find targets.

Alternatively, you can begin entering the name of the target in the **Search** field to filter the results and quickly find the target you want.

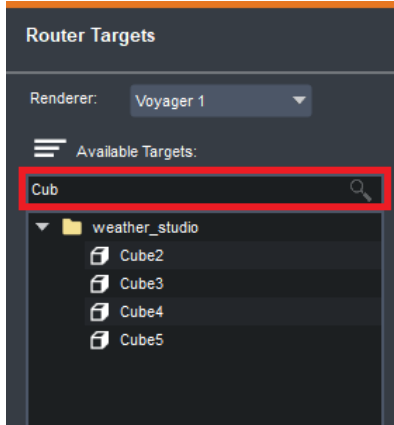

Router Targets - Search

6. Double-click targets to add them to the **Targets** field box.
7. Select **Close** to exit the **Router Targets** pane.

To add a source material to a target:

- Select the source and then select the target to which you want to apply it.
- OR**
- Select the target and then select the source material you want to apply to it.

To edit a target:

1. Right-click on a target.
2. A set of target actions is displayed.

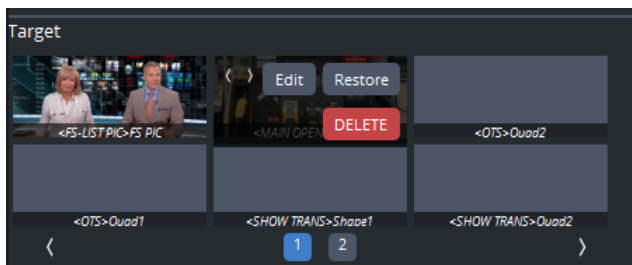

Target Actions

3. Select **Edit**.

The **Target Editor** opens.

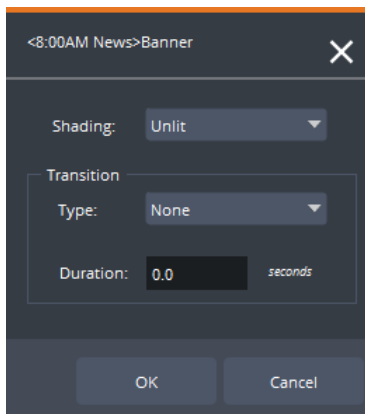

Target Editor

4. From the **Shading** drop-down, select whether the material that is applied to that target will be affected by light or not.

The options are:

- **Lit**
- **Unlit** (Default)

5. From the **Transition Type** drop-down, select the transition mode in which a material is applied to the target.

The options are:

- Linear (Default)
- Cubic
- Quintic
- Exponential
- Quadratic
- Quartic
- Sinusoidal
- Circular

6. In the **Duration** field, enter the number of seconds it will take for the current source to transition to the new source on the target (cross-fade duration).

7. Then select **OK**.

To delete a target:

1. In the **Router** panel, right-click on a target.
2. Select **Delete**.
3. In the confirmation dialog, select **OK**.

To restore a target:

1. Right-click on a target.
2. Select **Restore**.

The target reverts to its original state, either blank or with the original source or material applied.

Groups

You can assign targets to a group, allowing you to change the source on multiple targets (for example, one image on 3 different screens) all at once. Once assigned to a group, a target is no longer available as a single target.

[To create a group](#)

[To delete a target from a group](#)

To create a group:

1. In the **Groups** field, click the **+** sign in the bottom-right corner of the field to add a group.
2. Enter a name for the group and select **OK**.
3. Select the group you just created.

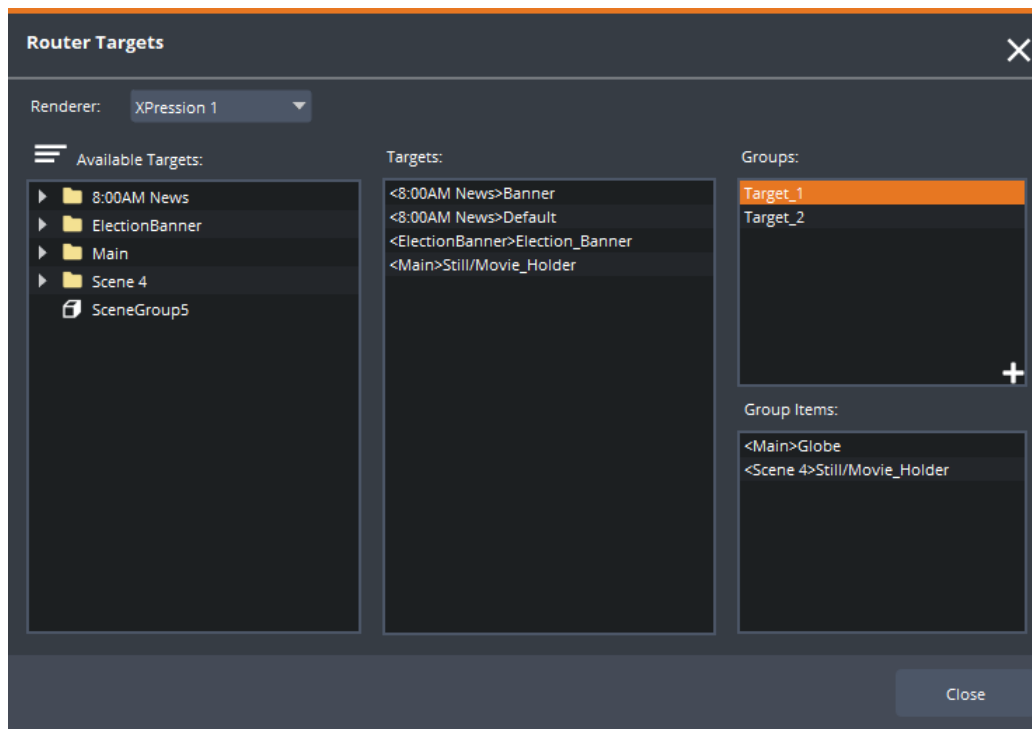

Router - Target Groups

4. Left-click and drag items from the **Targets** field box into the **Group** Items field box to add them to the selected group.
5. Select **Close** to exit the **Router Targets** pane.
6. The new group appears in the **Targets** section of the **Router** panel with the **Target Group** icon  in the top-right corner.

To delete a target from a group:

1. Select an item in the **Group Items** field box.
2. Then right-click and select **Delete** to remove the item from the group.

Presets

There can be many sources and targets for one project so the Router panel includes Presets, which stores assignments for sources and targets.

This section describes the following procedures:

[To create a Preset](#)

[To play a Preset](#)

[To rename a Preset](#)

[To delete a Preset](#)

To create a Preset:

1. Select the **Router Presets** button.

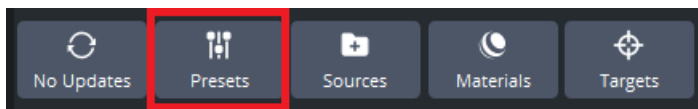

Router Presets Button

2. Then select the **+** icon in the bottom-right corner of the **Router Presets** field to save the current **Source** to **Router** assignment.

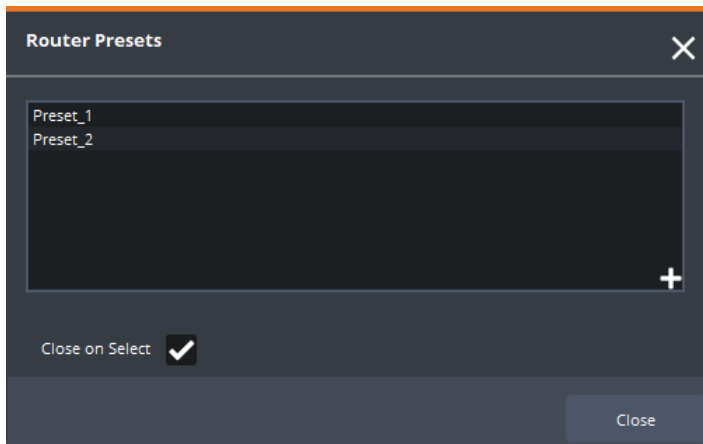

Router Presets

3. Select the **Close on Select** checkbox to close the **Router Presets** pane immediately after activating a preset or leave it unchecked to keep the pane open until all selections have been made.

To play a Preset:

1. Select the **Router Presets** button to select the preset you want to use.
2. Double-click the **Preset** name to activate the preset.

To rename a Preset:

1. Right-click the preset name and select **Edit**.
2. In the **Edit Preset** window, enter a new name for the preset and select **OK**.

To delete a Preset:

1. Right-click the preset name and select **Delete**.
2. In the confirmation dialog, select **OK**.

No Updates/Updates

When files are added, removed or overwritten (with the same name as before) within the source path folder, the **Updates** button pulses, indicating that you need to select the button to update the sources in Lucid Studio. If there have been no changes, the **No Updates** button is displayed.



No Updates/Updates Buttons

Logic

You can use the Logic panel to automate processes or create advance features or interactivity with the renderer. Select [Function Blocks](#) from the drop-down menus and connect them to create a logic graph.

Using logic, it is possible to create a process that doesn't work as intended and can have unforeseen consequences in your Lucid Studio project. Use logic carefully and test it thoroughly.

The items that are being controlled by the logic graph need to first be added to a set in the Position panel. For instructions, see [To add items to a set:](#).

An indicator in the bottom-right corner of the panel provides information about the average computing time of the selected logic graph. This time is only calculated when there is a change in any of the function blocks in the logic graph. The logic only runs when there has been a change.

When you create a new logic graph, you'll see information in the top-left corner, indicating the number of nodes, number of connections and the average computing time.

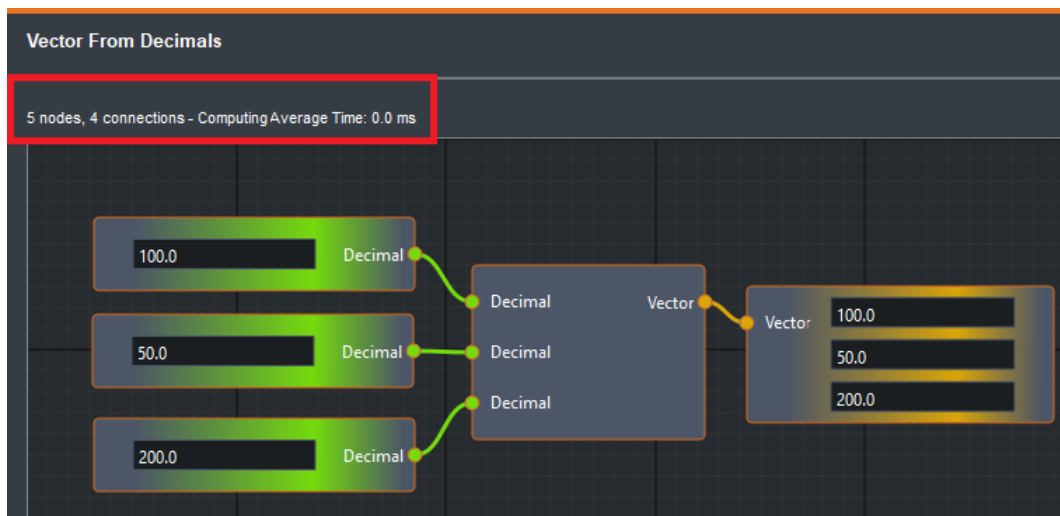

Logic Graph - Information

This section contains the following topics:

[Using Visual Logic](#)

[Function Blocks](#)

Using Visual Logic

The following section provides instructions for creating visual logic flows and graphs to use in your projects.

- A logic flow is a small group of logic blocks that execute a particular function.
- A logic graph is comprised of a number of logic flows that work together to create an automated process.
- Logic flows are not linear. If you have two or more logic flows running in parallel, they may not be in sync, i. e., one may finish before the other, causing a temporarily incorrect value that will correct itself when the other flow finishes.

It can be useful to create and export logic flows that you think you may want to use again in other projects. These flows can then be merged into a new logic graph, rather than recreating the flow each time.

To add a function block to the Logic workspace:

1. In the **Logic** panel, select the **+** icon in the bottom-right corner of the pane.

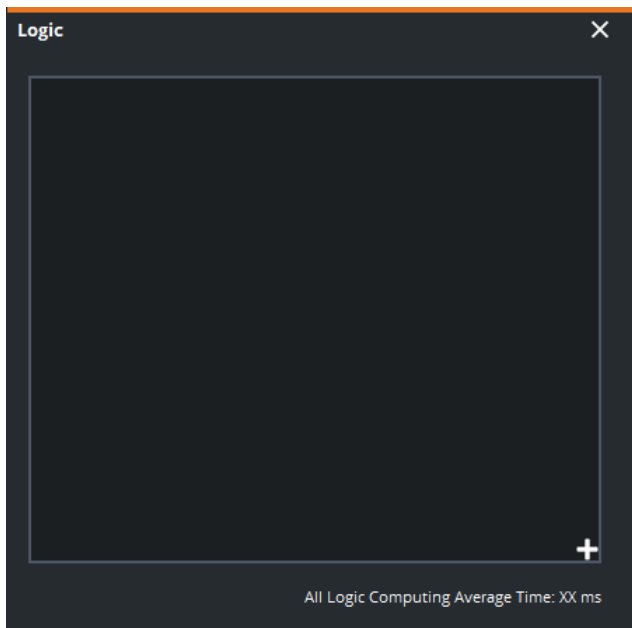

Logic panel

2. The logic workspace opens.

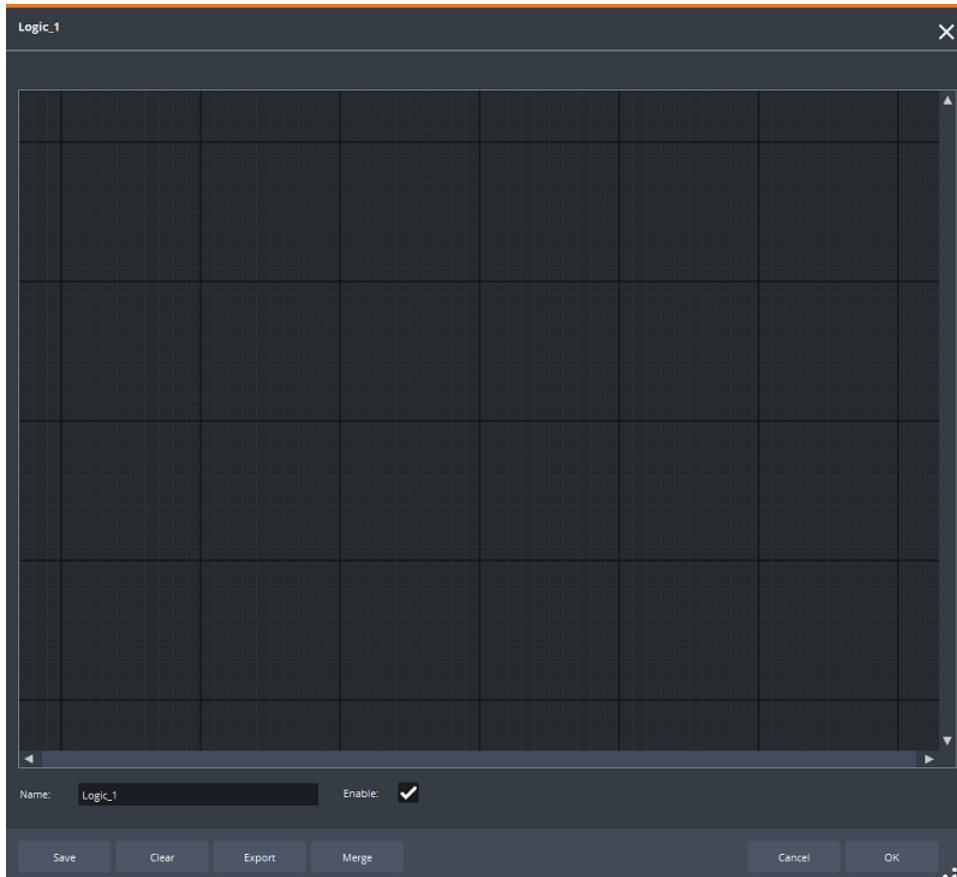

Logic Workspace

3. Right-click anywhere in the workspace and from the **Function Group** menu, select one of the groups.

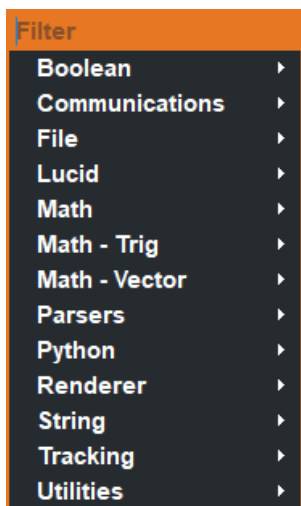

Logic Function Group Menu

4. Hover your mouse over a function group to access the function block list for that group.

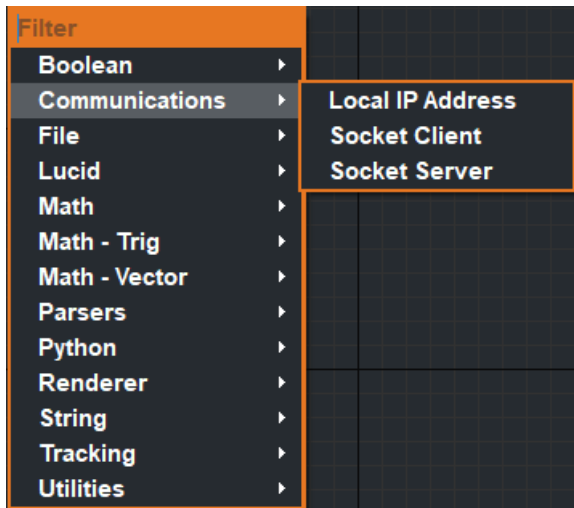

Logic - Expanded Function Group

You can also type the name of a function block in the **Filter** field to bring up the specific block or start typing the name of a function block in the **Filter** field, to bring up a list of blocks containing those letters.

5. In the expanded function block list, select to select a function block.

The function block is added to the workspace.

6. Hover your mouse over the function block to see a tooltip with a description of the block.

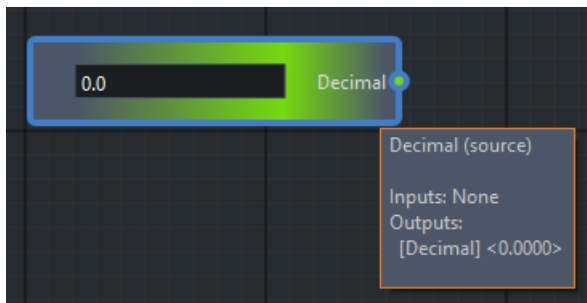

Logic - Function Block with Tooltip

Descriptions and examples of the function blocks are also available in the [Function Blocks](#) section of this document.

7. Continue adding function blocks to create a logic flow that will execute a particular function.

8. Left-click and drag off an input or output pin of any function block to see only the function blocks that are compatible with that pin.

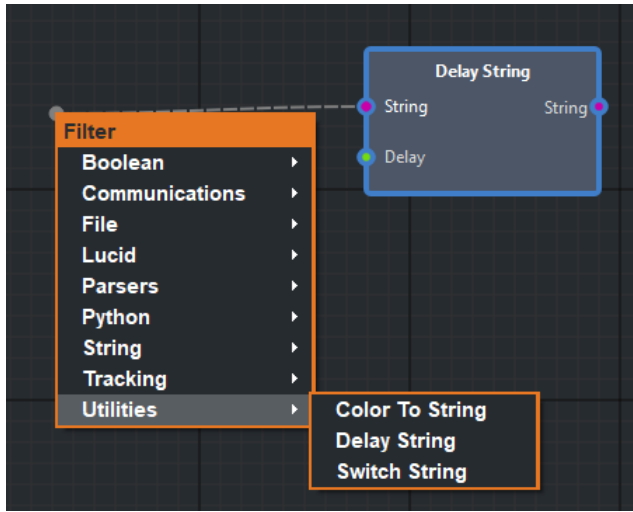

Logic - Context Aware Menu

9. In the bottom-left corner of the screen, below the logic workspace, enter a name for your logic flow and then select **OK**.

The logic flow is saved and appears in the **Logic** pane.

- logic flows or graphs that are enabled have a green check mark icon beside them.
- logic flows/graphs that are disabled have a yellow check mark icon beside them.

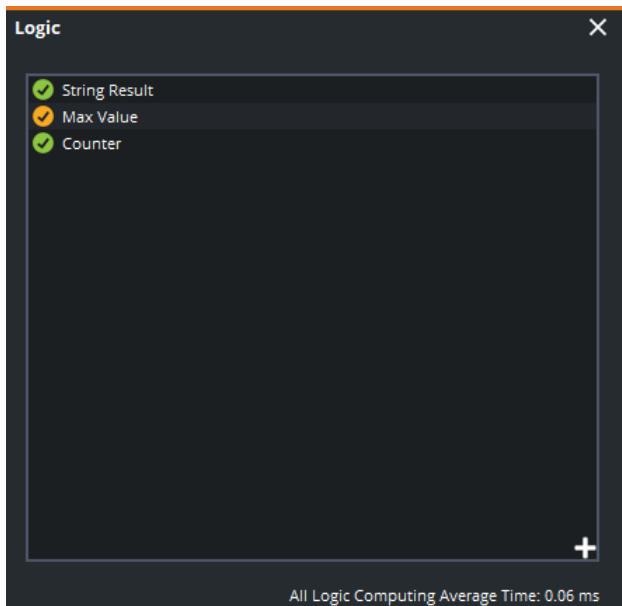

Saved Logic Flows

To clear the logic workspace:

1. In the bottom-left corner of the logic workspace, select **Clear**.

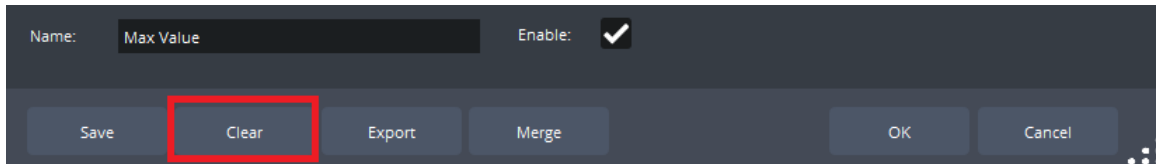

Clear Logic

2. In the **Confirmation** dialog, select **OK** to clear the workspace.

To export a logic graph:

1. In the bottom-left corner of the logic workspace, select **Export**.

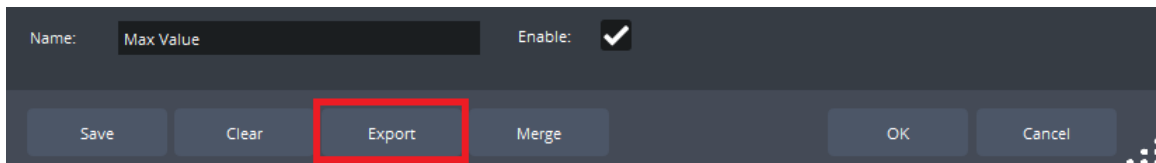

Export Logic

2. In the **New File** browser, navigate to the folder where you want to export your logic graph.

The entire logic graph is exported. You can't export just one flow of the graph. However, if you create a single logic flow, you can export that as a graph and have it available to merge with new graphs.

3. In the **File** name field, enter a name for the logic graph and select **Save**.

The graph is saved as a **.uxlg** file.

To merge a logic graph:

1. In the bottom-left corner of the logic workspace, select **Merge**.

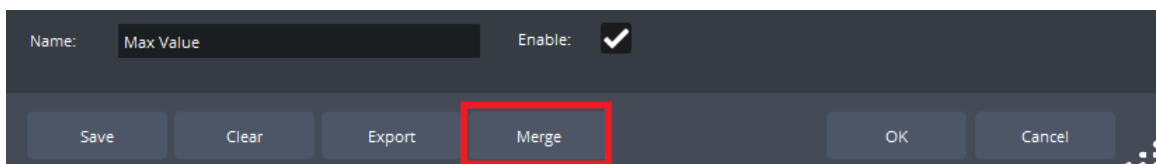

Merge Logic

2. In the **Select File** browser, navigate to the folder containing the logic graph (**.uxlg** file) you want to merge into the current logic workspace.

3. Select the logic graph you want to merge and select **Open**.

The logic graph is imported into the current logic workspace and is selected.

4. Select the logic graph while it is still selected and drag it elsewhere in the logic workspace.

Imported logic graphs are inserted in the same position each time, so if you already have function blocks in that position or if you intend to import more logic graphs, you will want to move the imported logic graph immediately, to avoid having one logic graph directly on top of another.

To enable your logic graph:

- Once you have built your logic graph, in the bottom-right corner of the logic workspace, beside the **Name** field, check to make sure the **Enable** checkbox is selected.

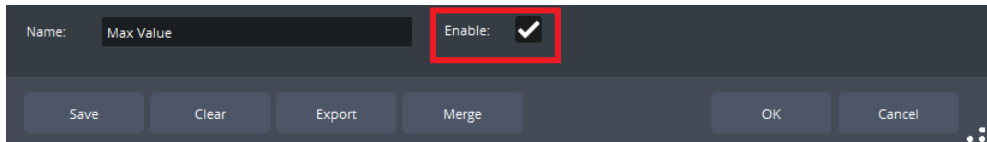

Enable Logic

The **Enable** checkbox is checked by default.

If you have created several logic graphs, enable only the ones you want to use in your current project.

To disable all logic graphs on startup:

- Without launching Lucid Studio, open the **Windows Command Prompt** window.
- In the **Command Prompt** window, navigate to the **C:\ROSS\Lucid\Lucid Studio** folder and type `Lucid_Loader.exe -disableLogic` as shown below:

★ The command line text is case-sensitive.

```
Command Prompt
Microsoft Windows [Version 10.0.18362.1139]
(c) 2019 Microsoft Corporation. All rights reserved.

C:\Windows\system32>cd\

C:\>cd c:\ross

c:\ROSS>Lucid_Loader.exe -disableLogic
```

Command Prompt to Launch Lucid Studio with Logic Disabled

- Press **Enter**.

Lucid Studio is launched with all logic graphs disabled.

Function Blocks

Function blocks are joined together to create a logic flow or graph that produces a particular result.

There are some useful features that will help you to achieve the result you want.

- The pin connectors on the left side of a function block are inputs, while the pin connectors on the right side are outputs.
- Some function blocks (eg. **String Source** or **String Result**) only have inputs or outputs, not both.
- The logic blocks and connectors are color-coded, to help visualize which blocks are needed as inputs or outputs.
- The tooltips for outputs in the function blocks indicate the values that result from the logic.
- The **Comment** function block is for informational purposes only and has no inputs or outputs.
- Function blocks display a message letting you know if there are missing or incorrect inputs.
- If you try to connect two function blocks that don't work together, the connecting line won't work.
- If you try to connect the wrong type of input, for example a decimal input when a string input is required, the logic application automatically inserts a function block that will convert the original input to a compatible input.
- An integer source must be in the range of **+/- 2,147,483,647**.
- A decimal source can be no larger than **999,999,999,999,999**.
- The logic workspace can be re-sized by left-clicking and dragging the bottom-right corner.

To select a function block:

- Left-click the function block.

To select multiple function blocks:

- While pressing the **Shift** key, left-click and drag the cursor across the function blocks.
The function blocks will be highlighted to indicate that they are selected.

To delete a function block:

- Left-click the function block you want to delete and then press **Delete** on the keyboard.

To delete multiple function blocks:

1. While pressing the **Shift** key, left-click and drag the cursor across the function blocks to select the ones you want to delete.
2. Then press **Delete** on the keyboard.

To copy a function block:

- Select the function block and press **Ctrl + C** and then **Ctrl + V**.

Function Block Descriptions

The available functions are described in the following sections:

[Boolean](#)

[Communications](#)

[File](#)

[Lucid](#)

[Math](#)

[Math - Trig](#)

[Math - Vector](#)

[Parsers](#)

[Python](#)

[Renderer](#)

[String](#)

[Tracking](#)

[Utilities](#)

Boolean

The **Boolean** functions are described in the table below:

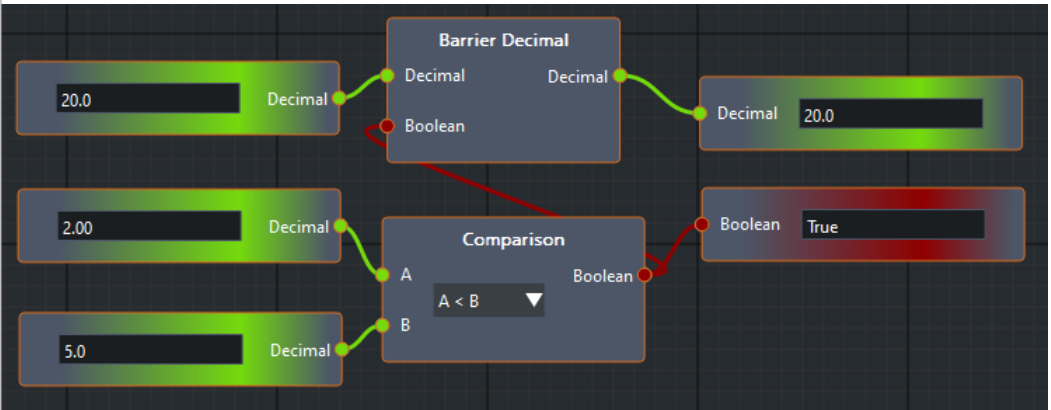
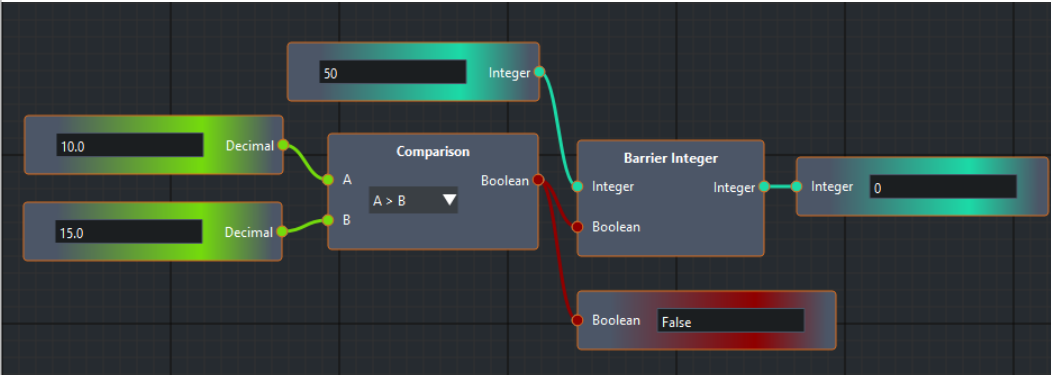
Function	Description
Barrier Decimal	<p>When the input statement is true, a change made in the input source is reflected in the output.</p> <p>Inputs: [Decimal] [Boolean]: True or False</p> <p>Output: [Decimal]</p> <p>Example:</p>  <p>The diagram shows a 'Barrier Decimal' block with two 'Decimal' ports and one 'Boolean' port. On the left, three 'Decimal' input boxes contain the values 20.0, 2.00, and 5.0. The top 'Decimal' port is connected to the 20.0 box, and the bottom 'Decimal' port is connected to the 5.0 box. The 'Boolean' port is connected to a 'Comparison' block. The 'Comparison' block has two 'Decimal' ports labeled 'A' and 'B', with 'A' connected to the 2.00 box and 'B' connected to the 5.0 box. The 'Comparison' block's dropdown menu is set to 'A < B'. Its 'Boolean' output is connected to the 'Barrier Decimal' block's 'Boolean' port. The 'Barrier Decimal' block's 'Decimal' output port is connected to a 'Decimal' output box containing the value 20.0.</p>
Barrier Integer	<p>When the input statement is true, a change made in the input source is reflected in the output.</p> <p>Inputs: [Integer] [Boolean]: True or False</p> <p>Output: [Integer]</p> <p>Example:</p>  <p>The diagram shows a 'Barrier Integer' block with one 'Integer' port and one 'Boolean' port. On the left, three 'Decimal' input boxes contain the values 10.0, 15.0, and 50. The top 'Decimal' port is connected to the 10.0 box, and the bottom 'Decimal' port is connected to the 15.0 box. The 'Boolean' port is connected to a 'Comparison' block. The 'Comparison' block has two 'Decimal' ports labeled 'A' and 'B', with 'A' connected to the 10.0 box and 'B' connected to the 15.0 box. The 'Comparison' block's dropdown menu is set to 'A > B'. Its 'Boolean' output is connected to the 'Barrier Integer' block's 'Boolean' port. The 'Barrier Integer' block's 'Integer' output port is connected to an 'Integer' output box containing the value 0. A separate 'Integer' input box containing the value 50 is also connected to the 'Barrier Integer' block's 'Integer' port.</p>

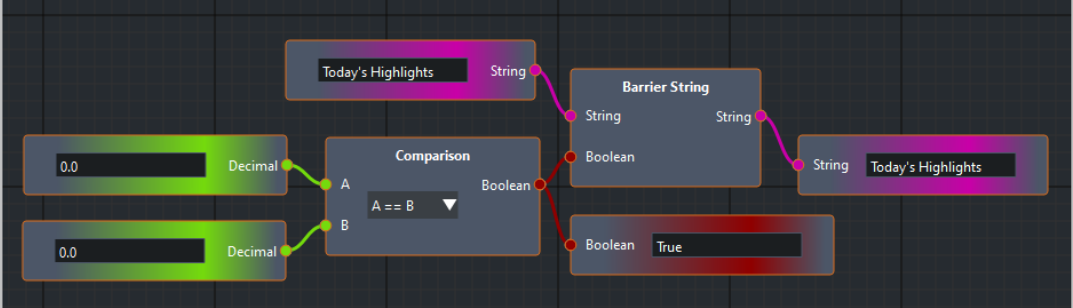
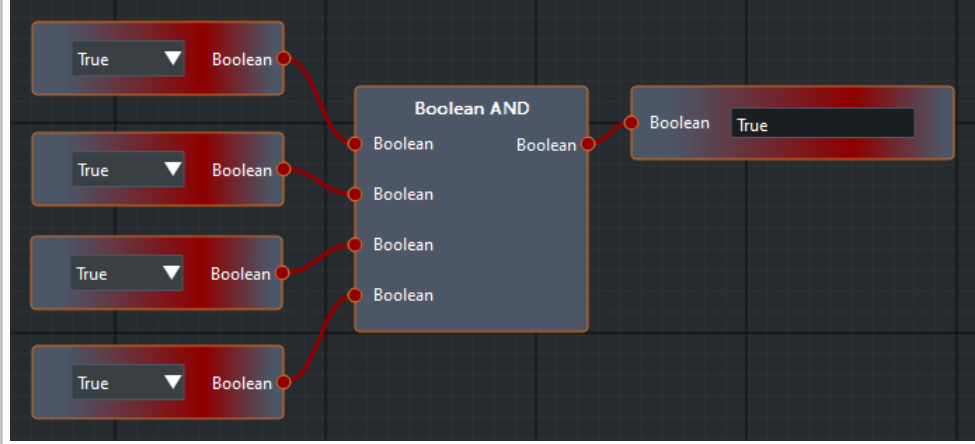
Function	Description
<p>Barrier String</p>	<p>When the input statement is true, a change made in the input source is reflected in the output.</p> <p>Inputs: [String] [Boolean]: True or False</p> <p>Output: [String]</p> <p>Example:</p> 
<p>Boolean AND</p>	<p>Outputs True only if all inputs are true. Outputs False if at least one of the inputs is false.</p> <p>Inputs: [Boolean]</p> <p>Output: [Boolean]</p> <p>Example:</p> 

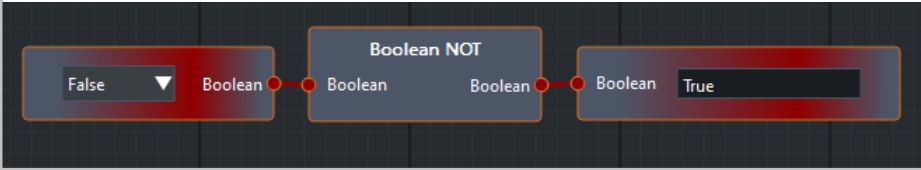
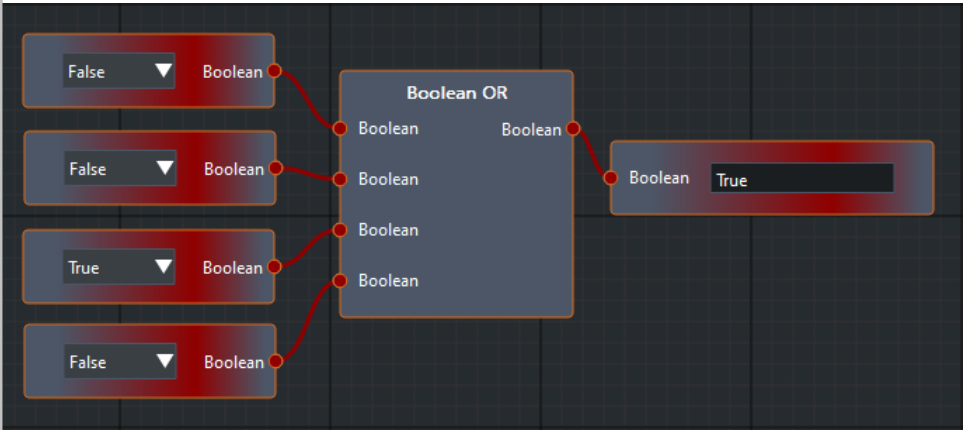
Function	Description
<p>Boolean NOT</p>	<p>Outputs the opposite of the input.</p> <p>Inputs: [Boolean]: True or False</p> <p>Output: [Boolean]: True or False</p> <p>Example:</p> 
<p>Boolean OR</p>	<p>Outputs True if any of four inputs is true.</p> <p>Inputs: [Boolean]: True or False</p> <p>Output: [Boolean]: True or False</p> <p>Example:</p> 
<p>Boolean Result</p>	<p>Displays the result of an operation as a Boolean.</p> <p>Inputs: [Boolean]: True or False</p> <p>Output: None</p> <p>Example: See the examples for Boolean AND, Boolean NOT, Boolean OR, etc.</p>
<p>Boolean Source</p>	<p>The Boolean sources (inputs) for an operation.</p> <p>Inputs: None</p> <p>Output: [Boolean]: True or False</p>

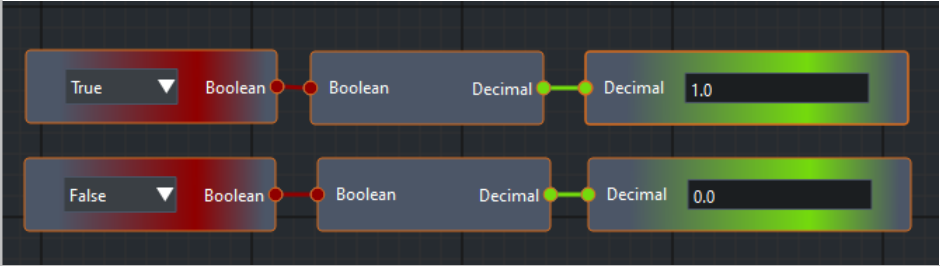
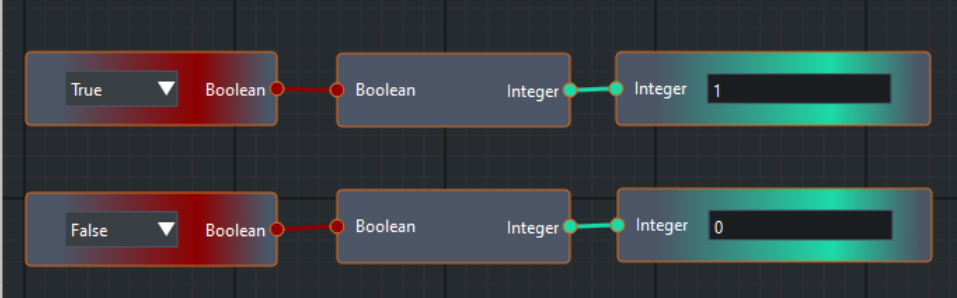
Function	Description
	<p>Example:</p> <p>See the examples for Boolean AND, Boolean NOT, Boolean OR, etc.</p>
<p>Boolean To Decimal</p>	<p>Displays a Boolean input as a decimal. If the Boolean input is True, the decimal output will be 1.0. If the Boolean input is False, the decimal output will be 0.0.</p> <p>Inputs:</p> <p>[Decimal]</p> <p>[Boolean]: True or False</p> <p>Output:</p> <p>[Decimal]</p> <p>Example:</p> 
<p>Boolean To Integer</p>	<p>Displays a Boolean input as an integer. If the Boolean input is True, the integer output will be 1. If the Boolean input is False, the integer output will be 0.</p> <p>Inputs:</p> <p>[Boolean]: True or False</p> <p>Output:</p> <p>[Integer]</p> <p>Example:</p> 

Function	Description
<p>Decimal To Boolean</p>	<p>Displays a decimal input as a Boolean result. If the decimal input is 0, the result is False. If the decimal input is anything other than 0, the result is True.</p> <p>Inputs: [Decimal]</p> <p>Output: [Boolean]: True or False</p> <p>Example:</p> 
<p>Integer To Boolean</p>	<p>Displays an integer input as a Boolean result. If the integer input is 0, the result is False. If the integer input is anything other than 0, the result is True.</p> <p>Inputs: [Integer]</p> <p>Output: [Boolean]: True or False</p> <p>Example:</p> 

Communications

The **Communications** functions are described in the table below:

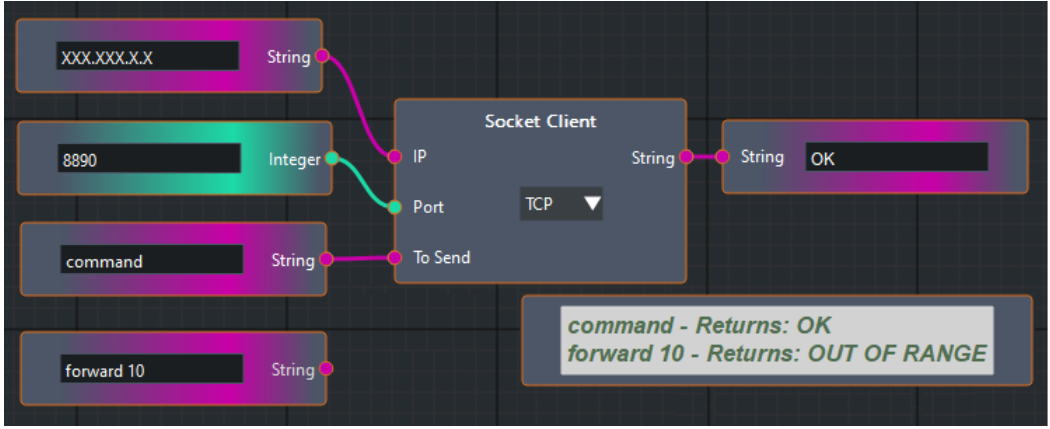
Function	Description
Local IP Address	<p>Contains a drop-down that allows you to select an available IP address. Used in conjunction with the Socket Server function block.</p> <p>Inputs: None</p> <p>Output: [String]</p>
Socket Client	<p>Sends messages to the specified IP address and port.</p> <p>Inputs: IP [String]: Destination server IP address Port: [Integer]: Destination port, either UDP or TCP To Send [String]: Message to send</p> <p>Output: [String]: Answer received from the server</p> <p>Example:</p> 

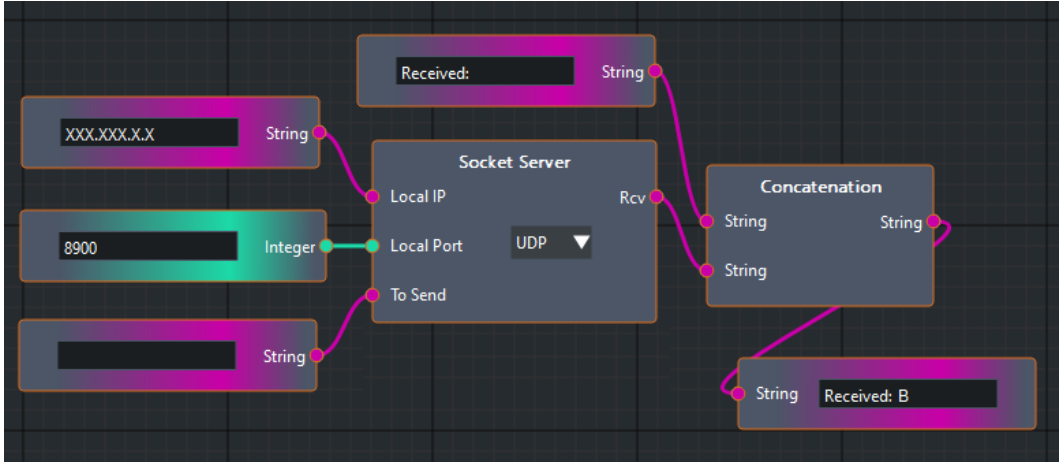
Function	Description
Socket Server	<p>Listens to messages coming to the specified IP address and port.</p> <p>Inputs:</p> <p>Local IP [String]: IP address of the server</p> <p>Local Port [Integer]: Port number on which to listen for incoming messages</p> <p>To Send [String]: Message to send to all connected clients (optional)</p> <p>Output:</p> <p>Rcv [String]: Message received</p> <p>Example:</p> 

File

The **File** function is described in the table below:

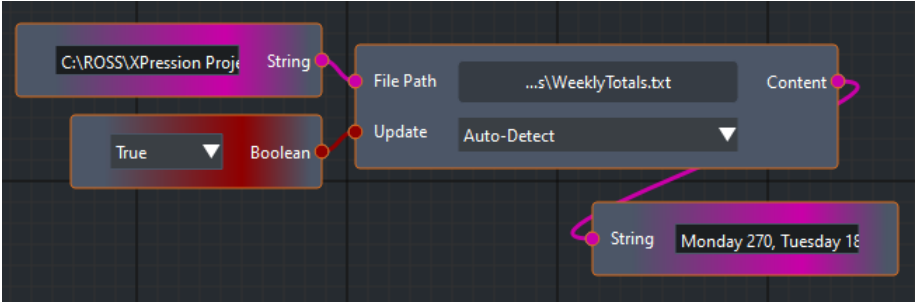
Function	Description
Text File	<p>Contains a drop-down that allows you to select a text file to read. Depending on the Update selection, the file will be reread as follows:</p> <ul style="list-style-type: none">• Auto-Detect: whenever the file changes• Polling: at the specified interval• Never Update: never reread <p>Inputs:</p> <p>File Path [String]: The path to the file to be read. If this input is available, the text file selected in the drop-down won't be used.</p> <p>Update [Boolean]: Manually update. When the input is set to True, the file will be manually reread.</p> <p>Output:</p> <p>Content [String]: All the text content as a string.</p> <p>Example:</p> 

Lucid

The **Lucid** functions are described in the table below:

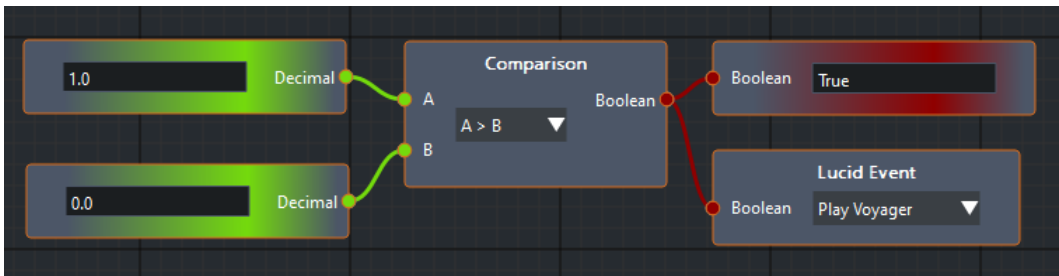
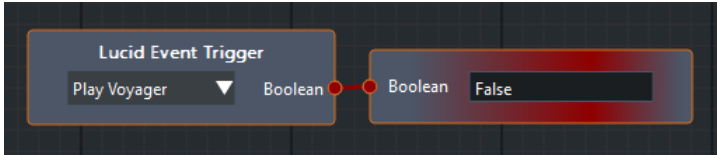
Function	Description
Lucid Event	<p>Runs a Lucid event when the inputs result in a true state.</p> <p>Input: [Boolean]</p> <p>Output: None</p> <p>Example:</p> 
Lucid Event Trigger	<p>Returns True when a Lucid event is triggered, then resets to False.</p> <p>Inputs: None</p> <p>Output: [Boolean]: True or False</p> <p>Example:</p> 

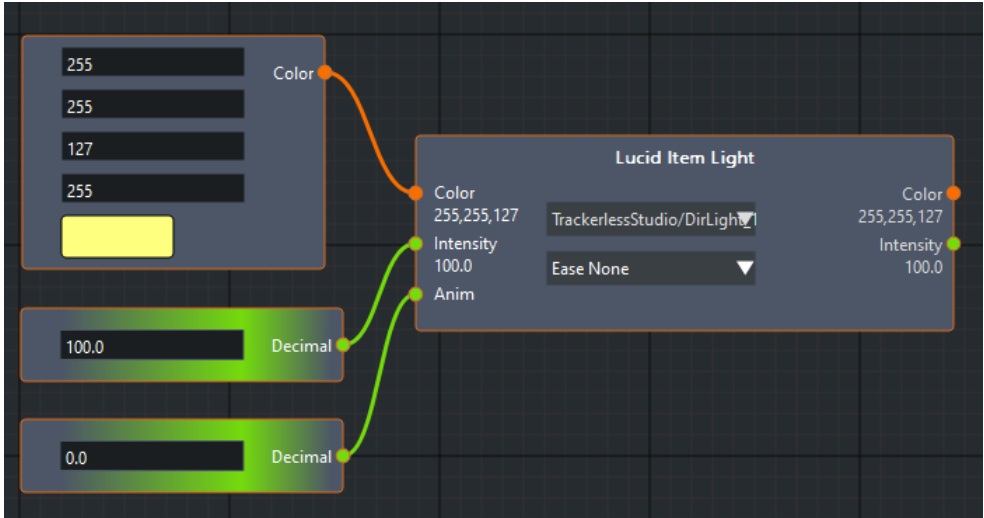
Function	Description
Lucid Item Light	<p>Changes the color and intensity of a light. Can also be used to read the light value, such as when the light reaches a particular color or intensity. You can have a Lucid Item Light function graph for each light in the scene.</p> <p>Select the item from the Item drop-down. The item must exist in a set in the Position panel, in order to be selectable.</p> <p>Select the easing type from the Easing drop-down.</p> <p>Inputs:</p> <p>Color [Color]: Color of the light</p> <p>Intensity [Decimal]: Intensity of the light</p> <p>Anim [Decimal]: Animation time in seconds</p> <p>Outputs:</p> <p>Color 0,0,0 [Color]: Color of the light</p> <p>Intensity 0.0 [Decimal]: Intensity of the light</p> <p>Example:</p> 

Function	Description
Lucid Item Position	<p>Changes the position of an item using its x, y, z coordinates. Can be used to move an item or read a position value, such as when the item reaches a specific position. The Anim input is used to specify a duration in seconds for the change in position.</p> <p>If an item's position is referenced in one enabled logic graph, it cannot be referenced in another.</p> <p>Select the item from the Item drop-down. The item must exist in a set in the Position panel, in order to be selectable.</p> <p>Values that have been set by Visual Logic are displayed in red in the Position panel data fields. These values are locked and can only be changed in the source data text file referenced by the logic graph.</p> <p>Inputs:</p> <p>X [Decimal]</p> <p>Y [Decimal]</p> <p>Z [Decimal]</p> <p>Anim [Decimal]: Animation time in seconds</p> <p>Outputs:</p> <p>X [Decimal]</p> <p>Y [Decimal]</p> <p>Z [Decimal]</p> <p>Example:</p>

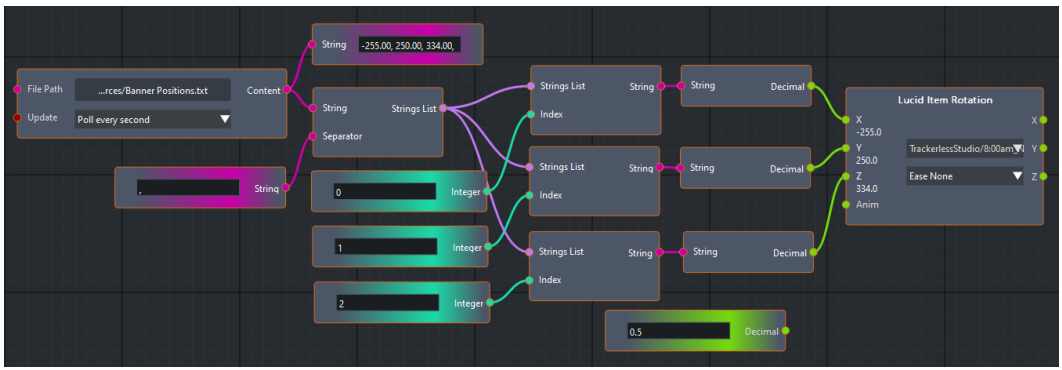
Function	Description
Lucid Item Rotation	<p>Changes the rotation of an item using its x, y, z coordinates. Can be used to rotate an item or read a rotation value, such as when the item rotates to a specific position. The Anim input is used to specify a duration in seconds for the change in rotation.</p> <p>If an item's rotation is referenced in one enabled logic graph, it cannot be referenced in another.</p> <p>Select the item from the Item drop-down. The item must exist in a set in the Position panel, in order to be selectable.</p> <p>Inputs:</p> <p>X [Decimal]</p> <p>Y [Decimal]</p> <p>Z [Decimal]</p> <p>Anim [Decimal]: Animation time in seconds</p> <p>Outputs:</p> <p>X [Decimal]</p> <p>Y [Decimal]</p> <p>Z [Decimal]</p> <p>Example:</p> 

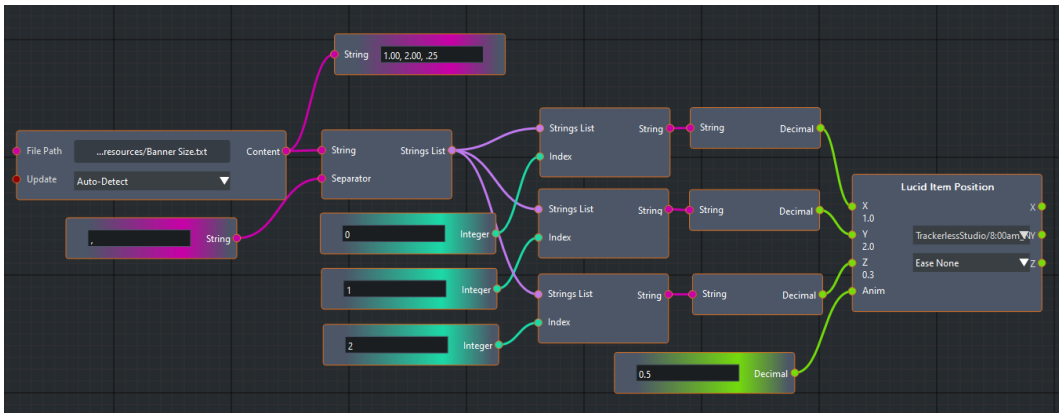
Function	Description
<p>Lucid Item Scale</p>	<p>Changes the scale of an item using its x, y, z coordinates. Can be used to change the scale of an item or read a scale value, such as when the item reaches a specific size. The Anim input is used to specify a duration in seconds for the change in scale.</p> <p>If an item's scale is referenced in one enabled logic graph, it cannot be referenced in another.</p> <p>Select the item from the Item drop-down. The item must exist in a set in the Position panel, in order to be selectable.</p> <p>Inputs:</p> <p>X [Decimal]</p> <p>Y [Decimal]</p> <p>Z [Decimal]</p> <p>Anim [Decimal]: Animation time in seconds</p> <p>Outputs:</p> <p>X [Decimal]</p> <p>Y [Decimal]</p> <p>Z [Decimal]</p> <p>Example:</p> 

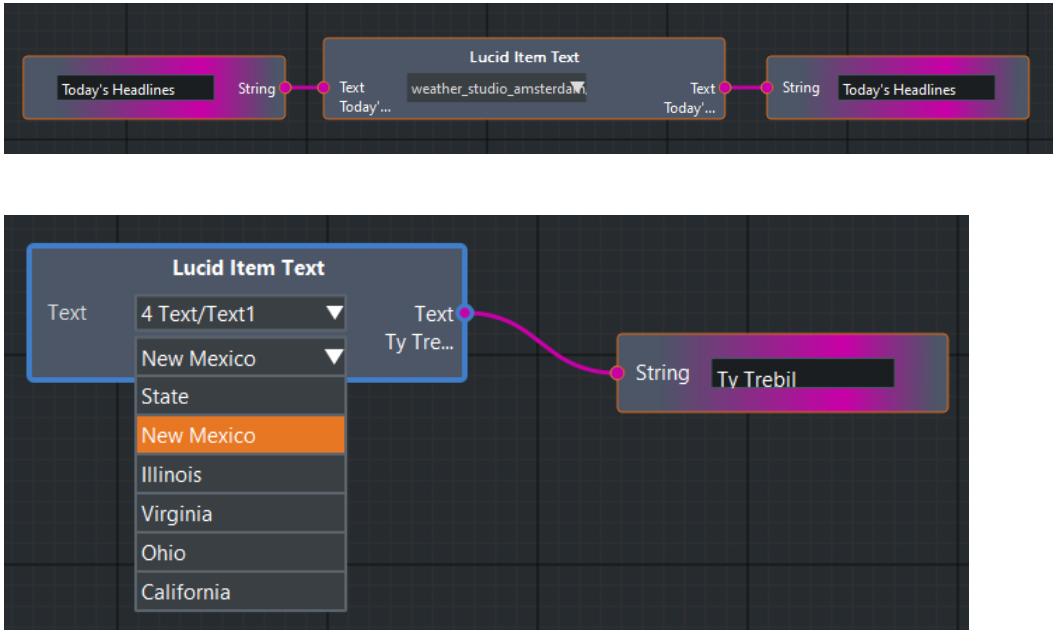
Function	Description
<p>Lucid Item Text</p>	<p>Updates the text of the selected Lucid item according to the input. Only one Lucid Item Text can be referenced in a logic flow or graph.</p> <p>Select the text item from the Item drop-down. The item must exist in a set in the Position panel, in order to be selectable.</p> <p>The Item drop-down can also contain a Static List, if there is one configured in the Position panel. See User Input Control for more information.</p> <p>Input: Text [String]</p> <p>Output: Text [String]</p> <p>Examples:</p> 

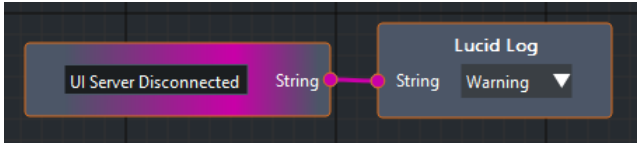
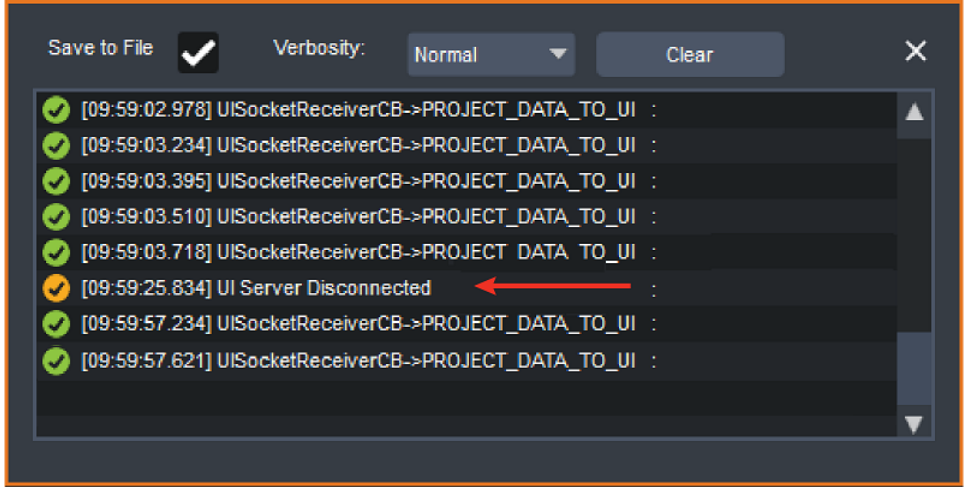
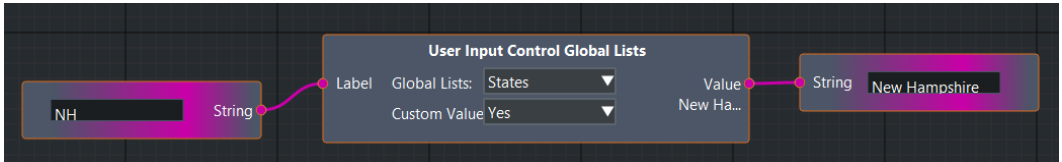
Function	Description
Lucid Log	<p>Prints a string in the Lucid Log. You can use the drop-down to categorize the message and the icon beside the message will appear in the corresponding color.</p> <ul style="list-style-type: none"> • Info - Green • Warning - Yellow • Error - Red <p>Input: Text [String]</p> <p>Output: None</p> <p>Examples:</p>  
User Input Control Global Lists	<p>Updates the text of an item from the selected Global list and the label that is selected as an input. See User Input Control for more information.</p> <p>Input: Text [String]</p> <p>Output: Text [String]</p> <p>Example:</p> 

Math

The **Math** functions are described in the table below

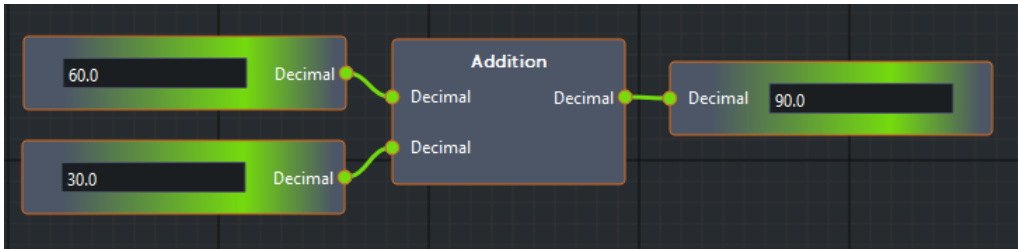
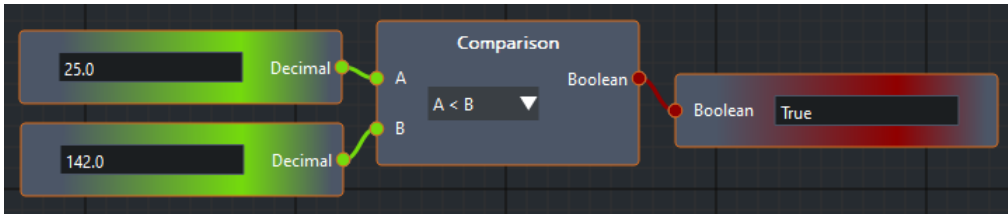
Function	Description
Addition	<p>Adds 2 decimal inputs.</p> <p>Inputs: A [Decimal] B [Decimal]</p> <p>Output: [Decimal]</p> <p>Example:</p> 
Comparison	<p>Compares 2 decimal inputs according to the criteria selected from the drop-down.</p> <p>Inputs: A [Decimal] B [Decimal]</p> <p>Output: [Boolean]: True or False</p> <p>Example:</p> 
Decimal Result	<p>Displays the result (output) of an operation as a decimal.</p> <p>Input: [Decimal]</p> <p>Output: None</p> <p>Example: See the examples for Addition and Comparison.</p>

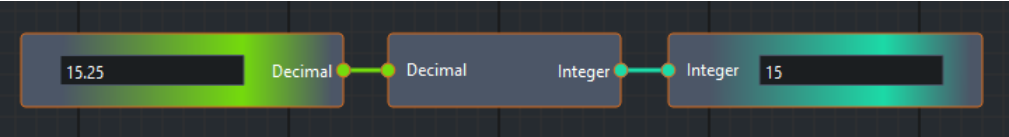
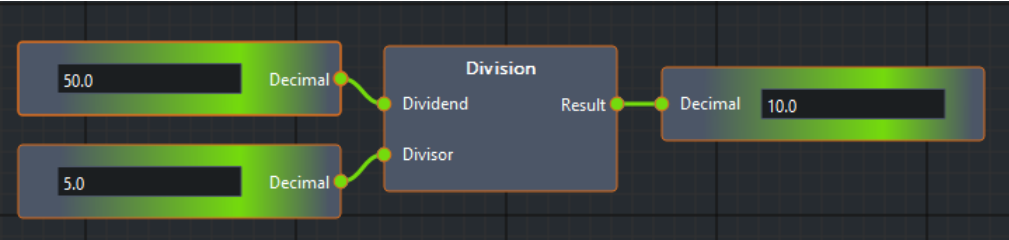
Function	Description
Decimal Source	<p>The decimal sources (inputs) for a math operation.</p> <p>Input: None</p> <p>Output: [Decimal]</p> <p>Example: See the examples for Addition and Comparison.</p>
Decimal To Integer	<p>Converts a decimal input to an integer.</p> <p>Input: [Decimal]</p> <p>Output: [Integer]</p> <p>Example:</p> 
Division	<p>Calculates the number of times the divisor is contained within the dividend.</p> <p>Inputs: Dividend [Decimal] Divisor [Decimal]</p> <p>Output: [Decimal]</p> <p>Example:</p> 

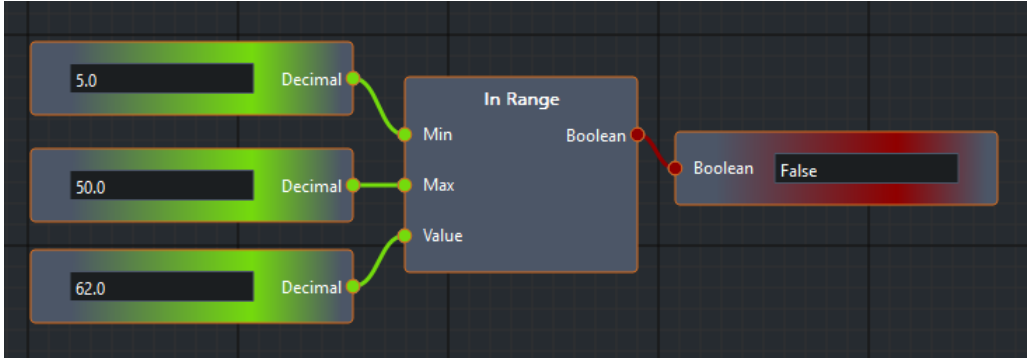
Function	Description
In Range	<p>Checks if the value is within the minimum and maximum limits of the range.</p> <p>Inputs:</p> <p>Min [Decimal]: Defines the minimum value of the range</p> <p>Max [Decimal]: Defines the maximum value of the range</p> <p>Value [Decimal]: The value to be checked</p> <p>Output:</p> <p>[Boolean]: True or False</p> <p>Example:</p> 
Integer Result	<p>Displays the result (output) of an operation as an integer.</p> <p>Input:</p> <p>[Integer]</p> <p>Output:</p> <p>None</p> <p>Example:</p> <p>See the example for Modulo.</p>
Integer Source	<p>The integer sources (inputs) for an operation.</p> <p>Input:</p> <p>None</p> <p>Output:</p> <p>[Integer]</p> <p>Example:</p> <p>See the example for Modulo.</p>

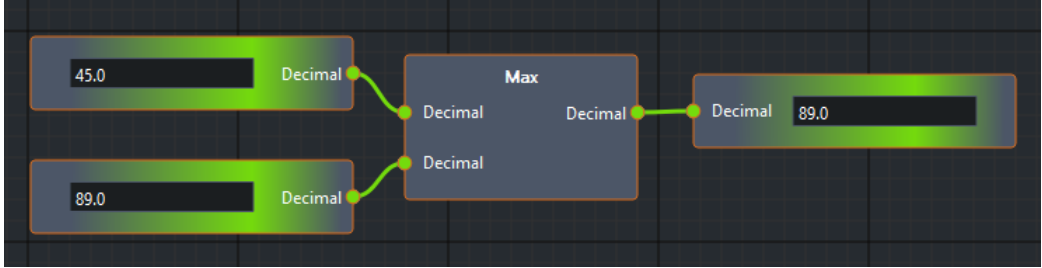
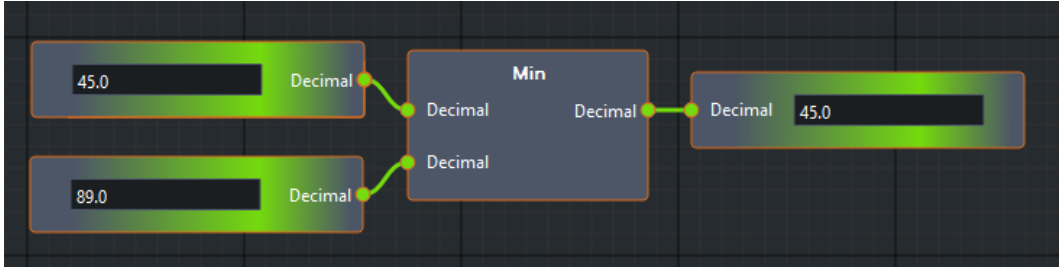
Function	Description
Integer To Decimal	<p>Converts an integer input to a decimal output.</p> <p>Input: [Integer]</p> <p>Output: [Decimal]</p> <p>Example:</p>  <p>The diagram shows a workflow on a dark grid background. On the left, a dark grey box with a green-to-blue gradient contains the number '150'. A blue line connects this box to a blue box labeled 'Integer'. Another blue line connects the 'Integer' box to a blue box labeled 'Decimal'. A final blue line connects the 'Decimal' box to a dark grey box with a green-to-blue gradient containing the number '150.0'.</p>
Max	<p>Finds the highest of two decimal values.</p> <p>Inputs: A [Decimal] B [Decimal]</p> <p>Output: [Decimal]</p> <p>Example:</p>  <p>The diagram shows a workflow on a dark grid background. On the left, there are two dark grey boxes with green-to-blue gradients. The top one contains '45.0' and the bottom one contains '89.0'. Each box is connected by a blue line to a central blue box labeled 'Max'. The 'Max' box has two 'Decimal' ports on its left side. A blue line connects the 'Max' box to a dark grey box with a green-to-blue gradient on the right containing '89.0'.</p>
Min	<p>Finds the lowest of two decimal values.</p> <p>Inputs: A [Decimal] B [Decimal]</p> <p>Output: [Decimal]</p> <p>Example:</p>  <p>The diagram shows a workflow on a dark grid background. On the left, there are two dark grey boxes with green-to-blue gradients. The top one contains '45.0' and the bottom one contains '89.0'. Each box is connected by a blue line to a central blue box labeled 'Min'. The 'Min' box has two 'Decimal' ports on its left side. A blue line connects the 'Min' box to a dark grey box with a green-to-blue gradient on the right containing '45.0'.</p>

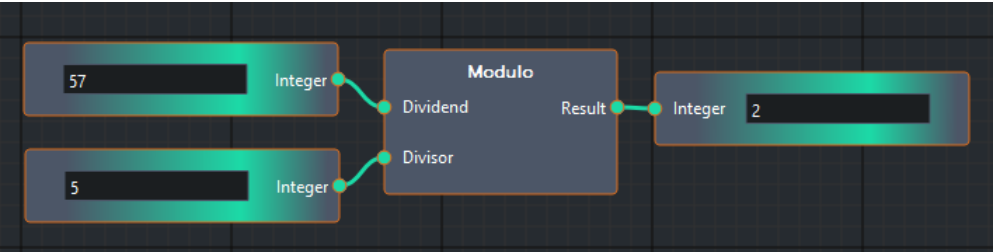
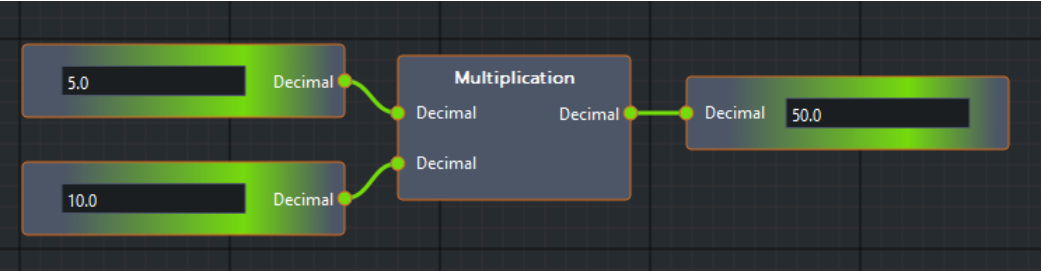
Function	Description
<p>Modulo</p>	<p>Finds the remainder of a division operation using integers.</p> <p>Inputs: Dividend [Integer] Divisor [Integer]</p> <p>Output: [Integer]</p> <p>Example:</p> 
<p>Multiplication</p>	<p>Multiplies two decimal inputs.</p> <p>Inputs: A [Decimal] B [Decimal]</p> <p>Output: [Decimal]</p> <p>Example:</p> 

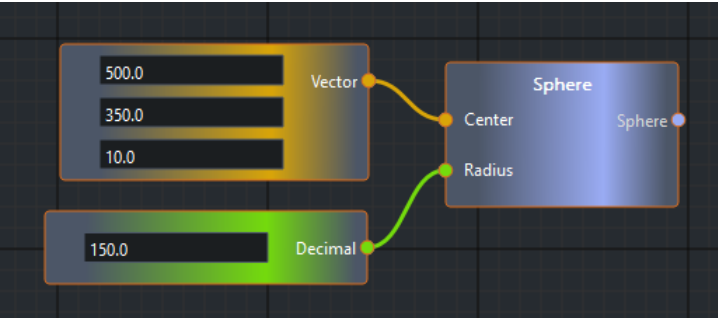
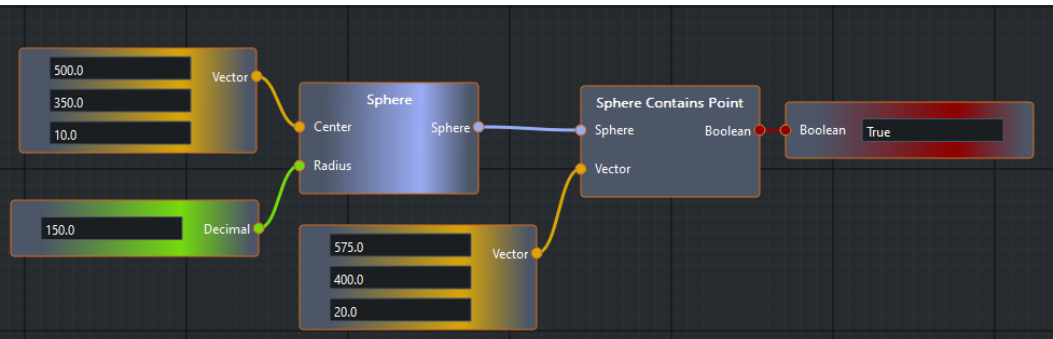
Function	Description
<p>Sphere</p>	<p>Defines the size and position of a sphere. This block is used in conjunction with the Sphere Contains Point and Sphere Intersection function blocks.</p> <p>Inputs:</p> <p>Center [Vector]: x, y, z</p> <p>Radius [Decimal]</p> <p>Output:</p> <p>[Sphere]</p> <p>Example:</p> 
<p>Sphere Contains Point</p>	<p>Checks if a 3D point is contained inside a sphere (true) or not (false). This block is used in conjunction with the Sphere function block.</p> <p>Inputs:</p> <p>[Sphere]</p> <p>[Vector]: x, y, z</p> <p>Output:</p> <p>[Boolean]: True or False</p> <p>Example:</p> 

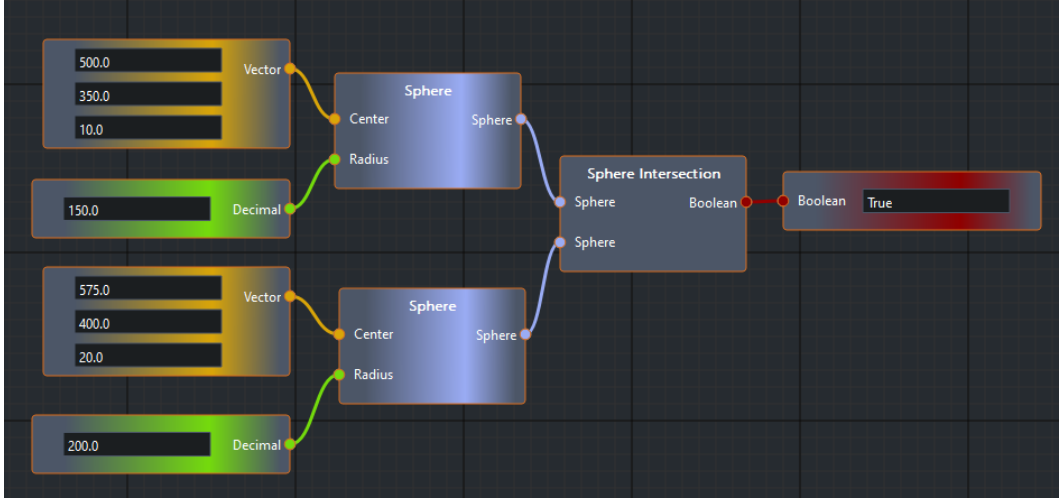
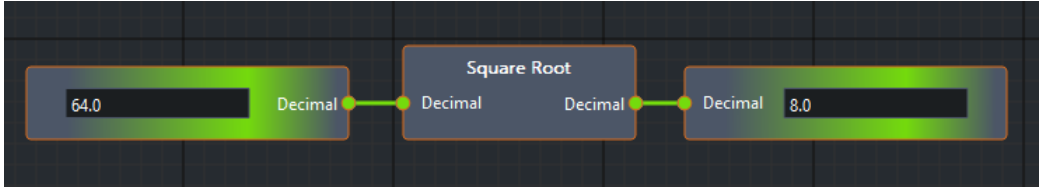
Function	Description
<p>Sphere Intersection</p>	<p>Checks if two spheres intersect (true) or not (false). This block is used in conjunction with two Sphere function blocks.</p> <p>Inputs: A [Sphere] B [Sphere]</p> <p>Output: [Boolean]: True or False</p> <p>Example:</p> 
<p>Square Root</p>	<p>Calculates the square root of a decimal number.</p> <p>Inputs: [Decimal]</p> <p>Output: [Decimal]</p> <p>Example:</p> 

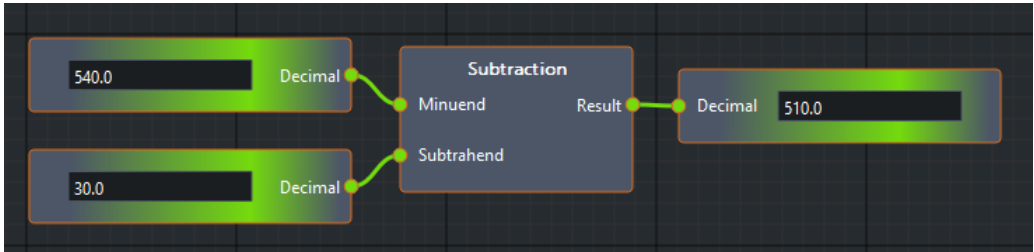
Function	Description
Subtraction	<p>Subtracts decimal input B (Subtrahend) from decimal input A (Minuend).</p> <p>Inputs: A [Decimal] B [Decimal]</p> <p>Output: [Decimal]</p> <p>Example:</p> 

Math - Trig

The **Math - Trig** functions are described in the table below:

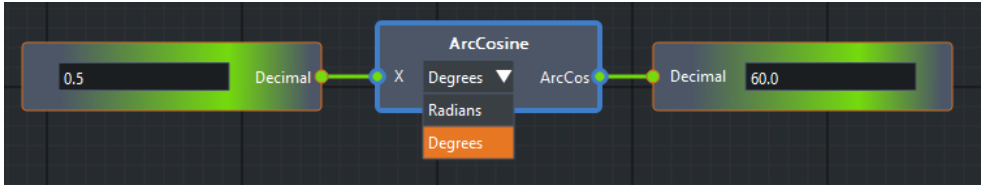
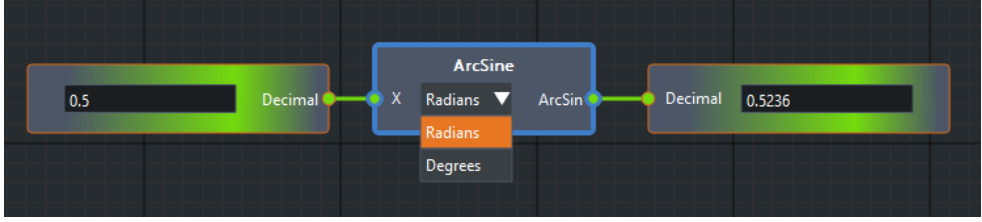
Function	Description
ArcCosine	<p>Calculates the arc cosine of X, in the interval $[0, \pi]$ radians or degrees, depending on the selection in the list menu.</p> <p>X should be in the interval $[-1, +1]$.</p> <p>Input: X [Decimal]</p> <p>Output: ArcCos [Decimal]</p> <p>Example:</p> 
ArcSine	<p>Calculates the arc sine of X, in the interval $[-\pi/2, \pi/2]$ radians or $[-90, 90]$ degrees.</p> <p>X should be in the interval $[-1, +1]$.</p> <p>Input: X [Decimal]</p> <p>Output: ArcSin [Decimal]</p> <p>Example:</p> 

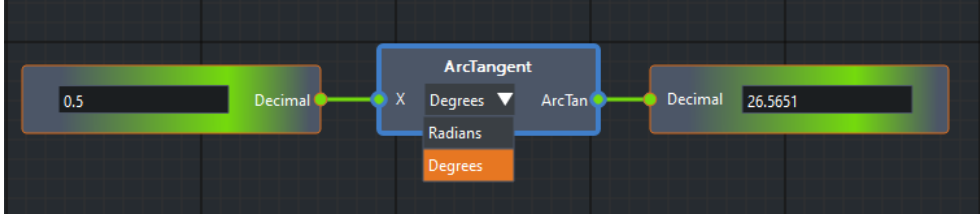
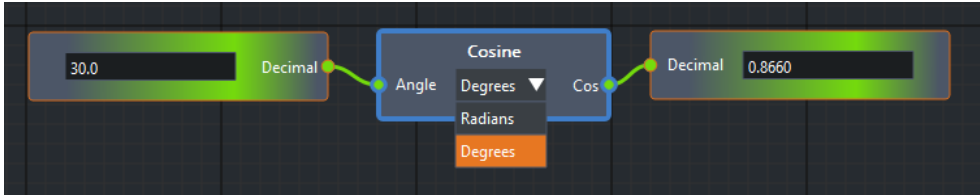
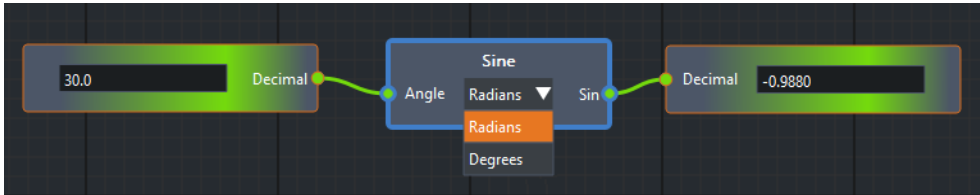
Function	Description
ArcTangent	<p>Calculates the arc tangent of X, in the interval $[-\pi/2, \pi/2]$ radians or $[-90, 90]$ degrees.</p> <p>X should be in the interval $[-1, +1]$.</p> <p>Input: X [Decimal]</p> <p>Output: ArcTan [Decimal]</p> <p>Example:</p> 
Cosine	<p>Calculates the cosine of the given angle in radians or degrees.</p> <p>Input: Angle [Decimal]</p> <p>Output: Cos [Decimal]</p> <p>Example:</p> 
Sine	<p>Calculates the sine of the given angle in radians or degrees.</p> <p>Input: Angle [Decimal]</p> <p>Output: Sin [Decimal]</p> <p>Example:</p> 

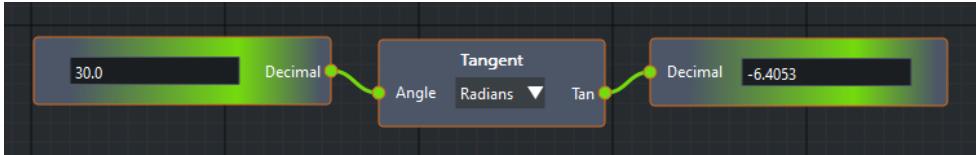
Function	Description
<p>Tangent</p>	<p>Calculates the tangent of the given angle in radians or degrees.</p> <p>Input: Angle [Decimal]</p> <p>Output: Tan [Decimal]</p> <p>Example:</p> 

Math - Vector

The **Math - Vector** functions are described in the table below:

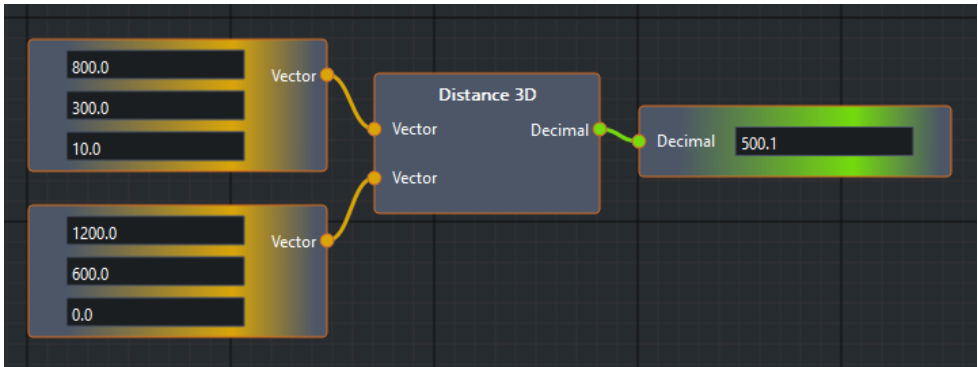
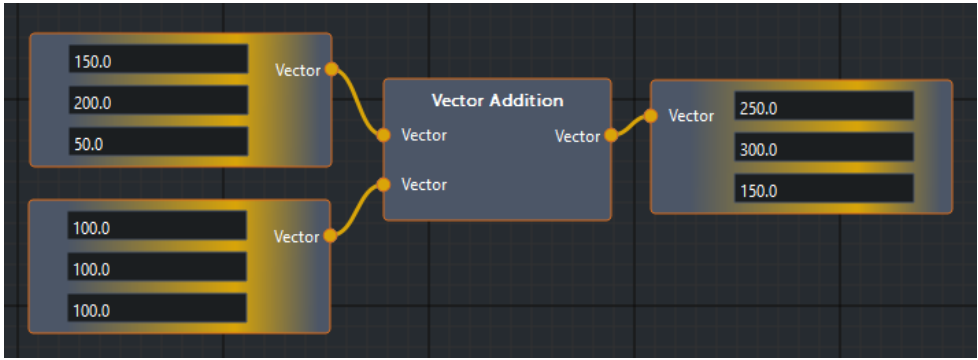
Function	Description
Distance 3D	<p>Calculates the distance between two 3D points.</p> <p>Inputs:</p> <p>A [Vector]: x, y, z</p> <p>B [Vector]: x, y, z</p> <p>Output:</p> <p>[Decimal]</p> <p>Example:</p> 
Vector Addition	<p>Adds two sets of 3D vector coordinates.</p> <p>Inputs:</p> <p>A [Vector]: x, y, z</p> <p>B [Vector]: x, y, z</p> <p>Output:</p> <p>[Vector]: x, y, z</p> <p>Example:</p> 

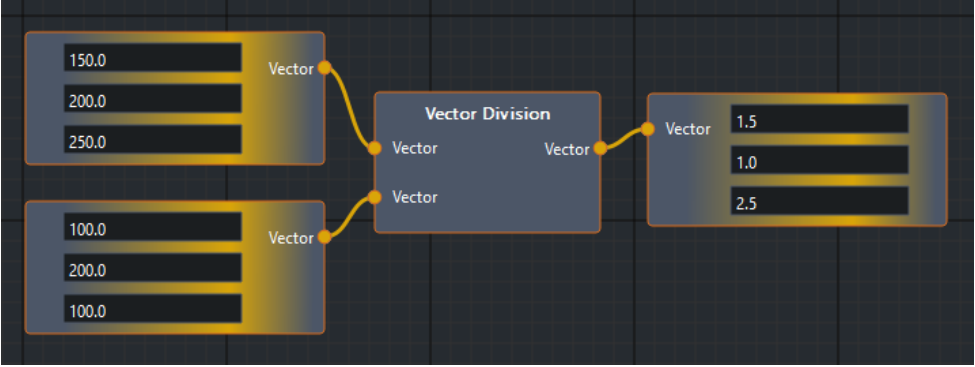
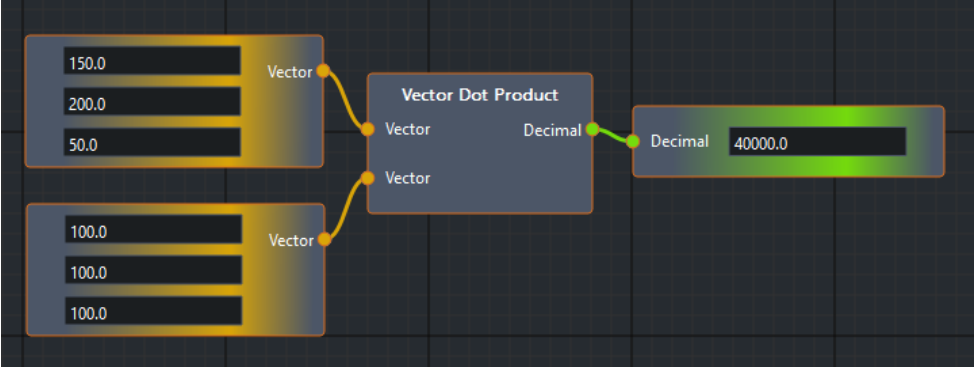
Function	Description
<p>Vector Division</p> <p>Divides the individual coordinates of two sets of 3D vector coordinates.</p> <p>Inputs: A [Vector]: x, y, z B [Vector]: x, y, z</p> <p>Output: [Vector]: x, y, z</p> <p>Example:</p>	
<p>Vector Dot Product</p> <p>Calculates the product of two vectors by multiplying the individual coordinates of one vector by the corresponding coordinates of the second vector and adding the results to return a single decimal number.</p> <p>Inputs: A [Vector]: x, y, z B [Vector]: x, y, z</p> <p>Output: [Decimal]</p> <p>Example:</p>	

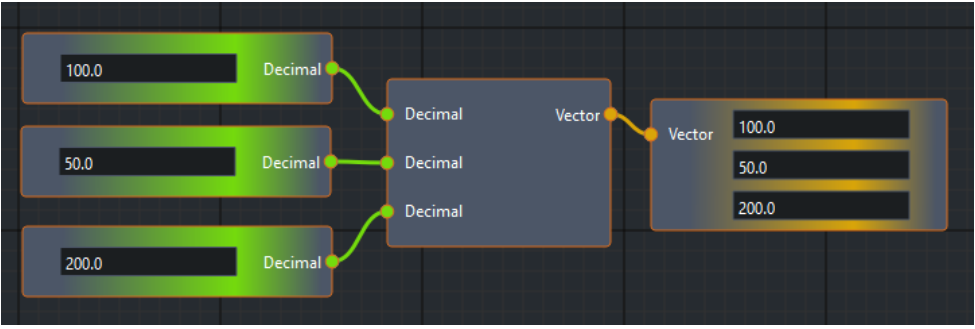
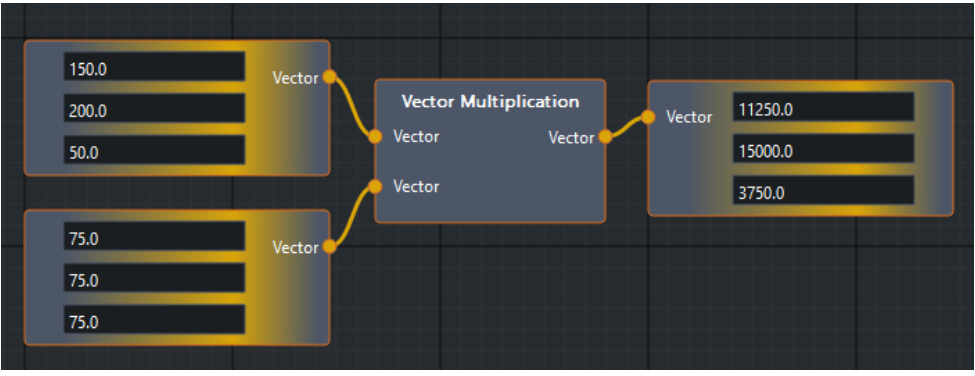
Function	Description
<p>Vector From Decimals</p>	<p>Creates a vector from three decimal sources.</p> <p>Inputs: A [Decimal] B [Decimal] C [Decimal]</p> <p>Output: [Vector]: x, y, z</p> <p>Example:</p> 
<p>Vector Multiplication</p>	<p>Multiplies two vectors, component by component .</p> <p>Inputs: [Vector]: x, y, z [Vector]: x, y, z</p> <p>Output: [Vector]: x, y, z</p> <p>Example:</p> 

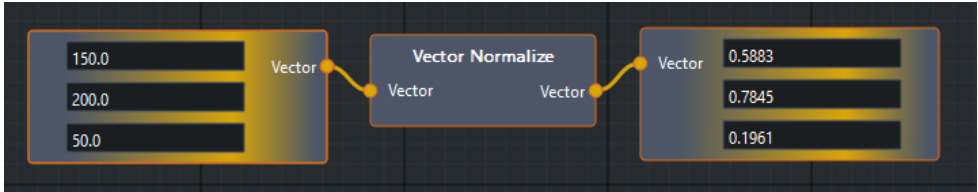
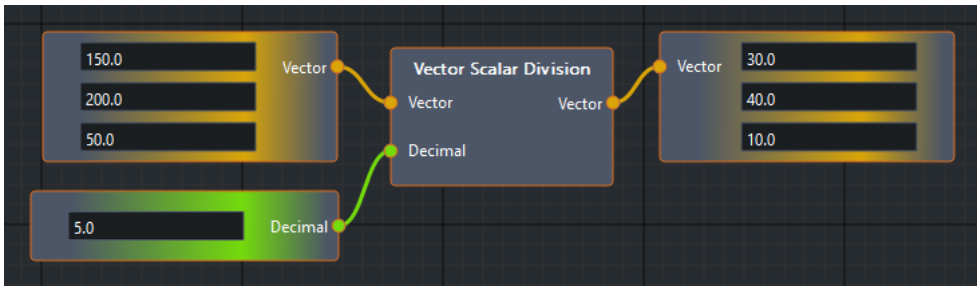
Function	Description
Vector Normalize	<p>Normalizes the vector input (same direction with length 1).</p> <p>Inputs: [Vector]: x, y, z</p> <p>Output: [Vector]: x, y, z</p> <p>Example:</p> 
Vector Result	<p>Displays the result (output) of an operation as a vector.</p> <p>Input: [Vector]: x, y, z</p> <p>Output: None</p> <p>Example: See the examples for Vector Addition, Vector Division, Vector Multiplication, etc.</p>
Vector Scalar Division	<p>Divides a 3D vector by a scalar (decimal).</p> <p>Input: [Vector]: x, y, z [Decimal]</p> <p>Output: [Vector]: x, y, z</p> <p>Example:</p> 

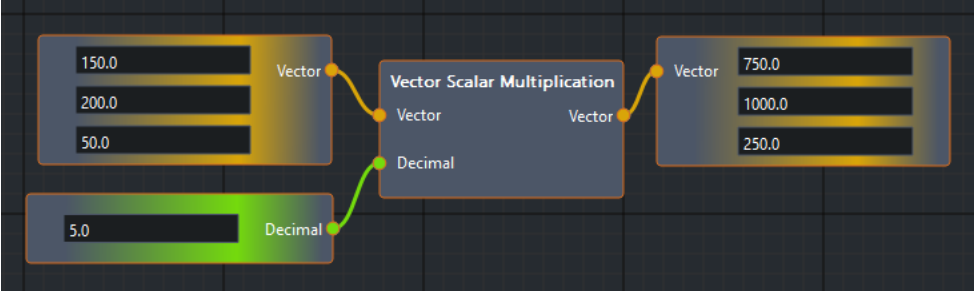
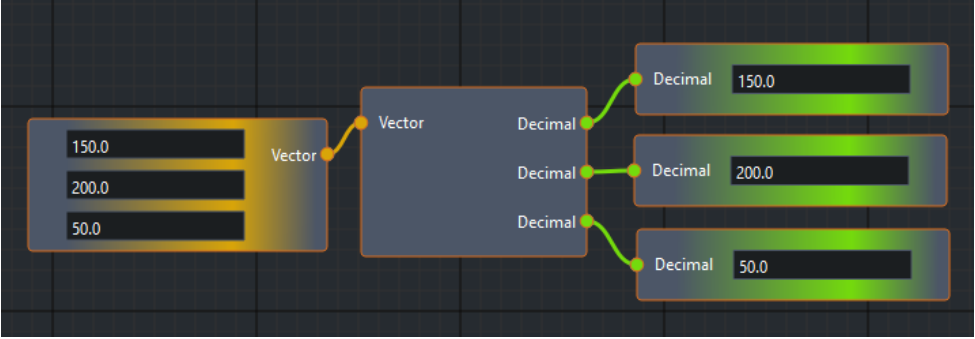
Function	Description
<p>Vector Scalar Multiplication</p>	<p>Multiplies a 3D vector by a scalar (decimal).</p> <p>Input: [Vector]: x, y, z [Decimal]</p> <p>Output: [Vector]: x, y, z</p> <p>Example:</p> 
<p>Vector Source</p>	<p>The vector sources (inputs) for vector operations.</p> <p>Input: None</p> <p>Output: [Vector]: x, y, z</p> <p>See the examples for Vector Addition, Vector Division, and Vector Multiplication.</p>
<p>Vector To Decimals</p>	<p>Separates a vector into three decimal numbers.</p> <p>Input: [Vector]: x, y, z</p> <p>Outputs: A [Decimal] B [Decimal] C [Decimal]</p> <p>Example:</p> 

Parsers

The **Parser** functions are described in the table below.

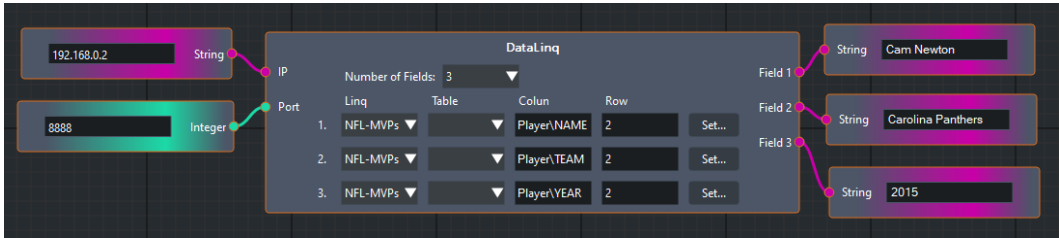
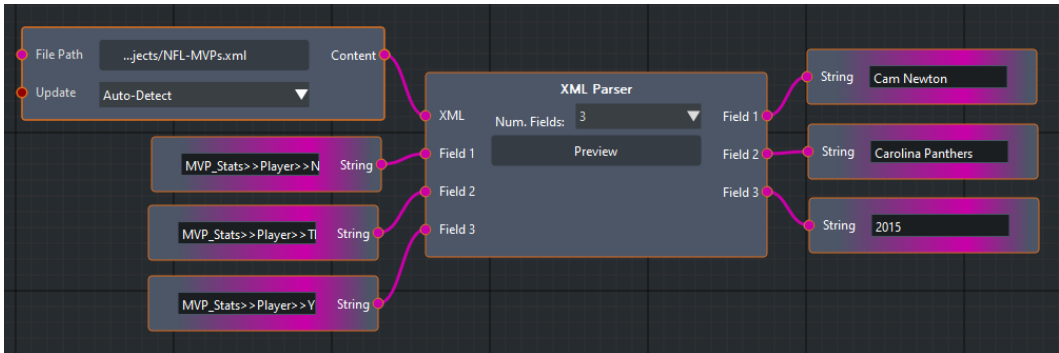
Function	Description
DataLinq	<p>Parses a DataLinq source and returns the values of the fields given as inputs. Select a number of fields (up to 10) to be parsed from the drop-down.</p> <p>Inputs:</p> <p>IP [String]: The IP address of the DataLinq server</p> <p>Port [Integer]: The port number of the DataLinq server</p> <p>Output:</p> <p>Fields 1 to 10 [String]: Value of the field queried</p> <p>Example:</p> 
XML Parser	<p>Parses an XML input string and returns the values of the XML fields given as inputs. Use the Text File function block to provide the path to the .xml source file.</p> <p>Inputs:</p> <p>XML [String]: XML string to be parsed</p> <p>Field 1 [String]: XML field to be returned</p> <p>Output:</p> <p>Field 1 [String]: Value of the XML field queried</p> <p>Example:</p> 

To use the XML Parser function:

1. In the **Text File** function block, use the drop-down to select the path to the .xml source file.
2. Before connecting the **Text File** function block to the **XML Parser** function block, select the number of fields to be parsed from the **Num. Fields** drop-down in the **XML Parser** function block.
3. Then connect the **Text File** function block to the **XML Parser** function block and connect the **String Source** and **String Result** function blocks.
4. Select the **Preview** button to open a window with the .xml data arranged in a tree structure.
5. Select the field you want to parse, select **Copy** and then **Close**.
6. Press **Ctrl + V** to paste the text into a **String Source** function block.
7. Repeat steps 4 to 6 for each field you want to parse.

Python

The **Python Script** function is described in the table below

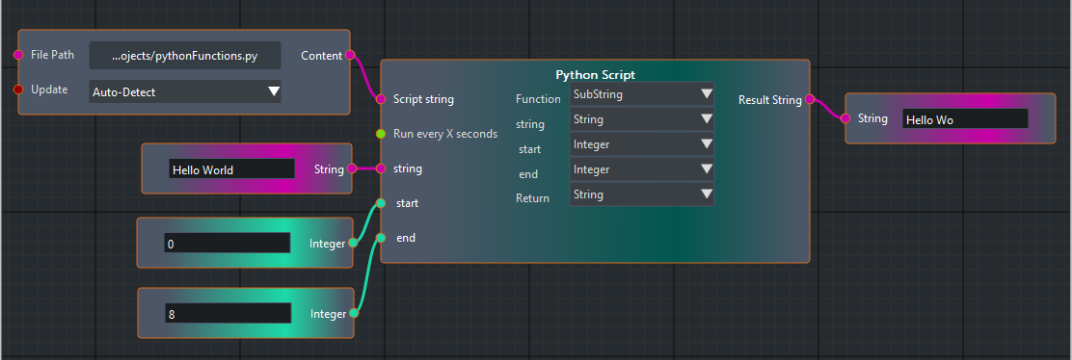
Function	Description
Python Script	<p>Runs a function(s) contained in a Python script. The inputs change depending on the Function selected in the drop-down.</p> <p>This function recognizes the functions contained in the Python script and lists them in a combo box. It will only list functions, not classes, methods, global variables, etc.</p> <p>You can choose to run the script every X seconds.</p> <p>This function should only be used with a script written by an experienced Python developer. A poorly-designed script can have unforeseen consequences.</p> <p>Inputs:</p> <p>Script string [String] Run every X seconds [Decimal] string [String] start [Integer] or [Decimal] or [String] or [List] (match the selection in the Python Script block) end [Integer] or [Decimal] or [String] or [List] (match the selection in the Python Script block)</p> <p>Output:</p> <p>[String]</p> <p>Example:</p> <p>(With SubString selected as the Function.)</p> 

Renderer

The **Renderer** function is described in the table below:

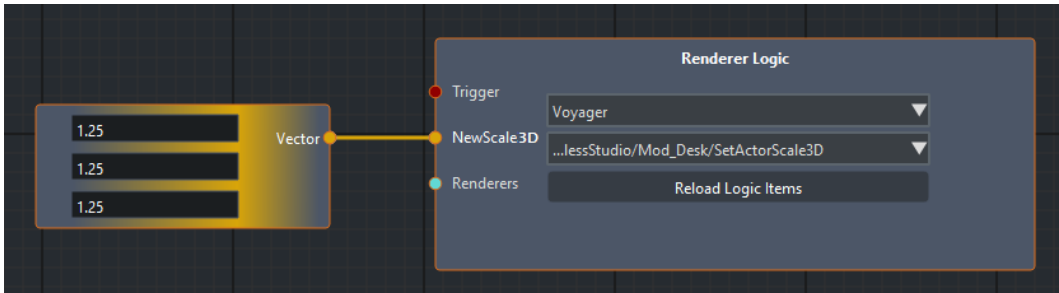
Function	Description
Renderer Logic	<p>This function queries the selected renderer and the renderer returns the values that can be set from the Renderer Logic function block.</p> <ul style="list-style-type: none">• Your Voyager project must be playing in PIE mode for the logic graph to work.• If no renderer input is specified, the data will be sent to all connected renderers.• If a renderer is selected from the first drop-down, the data will be sent to that renderer.• The second drop-down displays the available values from the selected renderer.• To reload logic items, first disconnect the Renderer Logic node from any other nodes.• You can also use a String source to input a list of renderers and then select the renderer(s) you want from the Renderer Logic drop-down (optional). <p>XPression</p> <p>The values of the following Material properties can be set:</p> <ul style="list-style-type: none">• Alpha• Ambient (Color)• Diffuse (Color)• Emissive (Color)• Specular (Color) <p>Voyager</p> <p>The values of the following Lucid Blueprint nodes can be set:</p> <ul style="list-style-type: none">• Lucid Exec• Lucid Float Async/Lucid Float• Lucid Rotator Async/Lucid Rotator• Lucid String Async/Lucid String• Lucid Vector Async/Lucid Vector• Send Message• Voyager Actor and Level functions that have been published in the Template Links window can also be set. <p>Inputs:</p> <p>Trigger (Boolean): Send command to execute a function.</p> <p>NewScale3D (Vector): 3D coordinates.</p> <p>Renderers (String List): Renderer(s) to send the command to.</p> <p>Output:</p> <p>None</p> <p>Examples:</p>  <p>The screenshot shows a logic graph with two nodes. On the left is a 'Vector' node with three input fields, each containing the value '1.25'. A yellow line connects the output of the 'Vector' node to the 'NewScale3D' input of the 'Renderer Logic' node on the right. The 'Renderer Logic' node has three inputs: 'Trigger' (red dot), 'NewScale3D' (yellow dot), and 'Renderers' (cyan dot). The 'NewScale3D' input is connected to the 'Vector' node. The 'Renderers' input is connected to a dropdown menu showing 'Voyager' and '...lessStudio/Mod_Desk/SetActorScale3D'. Below the dropdowns is a 'Reload Logic Items' button.</p>

For more information on using logic with the Voyager renderer, see [Lucid Studio and Voyager](#).

String

The **String** functions are described in the table below

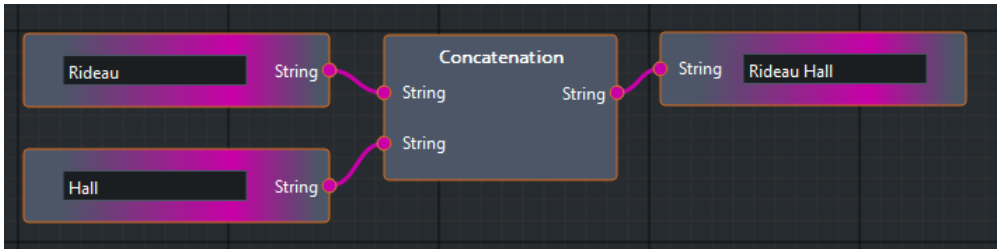
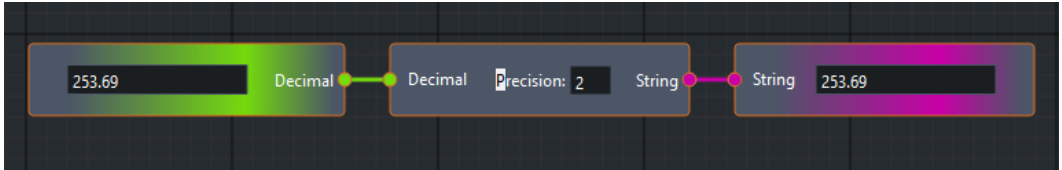
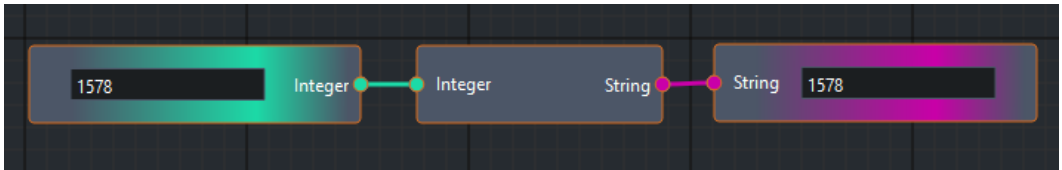
Function	Description
Concatenation	<p>Joins two input strings.</p> <p>Inputs:</p> <p>A [String] B [String]</p> <p>Output:</p> <p>AB [String]</p> <p>Example:</p> 
Decimal To String	<p>Converts a decimal to a string, rounding off to the number of decimal places specified in the Precision field.</p> <p>Input:</p> <p>[Decimal]</p> <p>Output:</p> <p>[String]</p> <p>Example:</p> 
Integer To String	<p>Converts an integer to a string.</p> <p>Input:</p> <p>[Integer]</p> <p>Output:</p> <p>[String]</p> <p>Example:</p> 

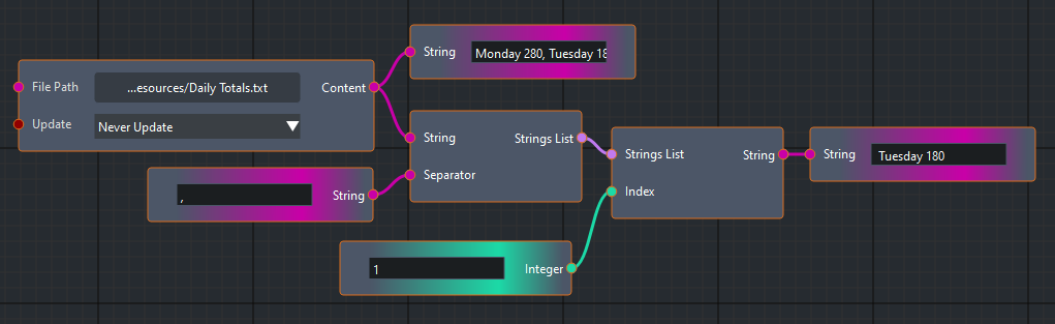
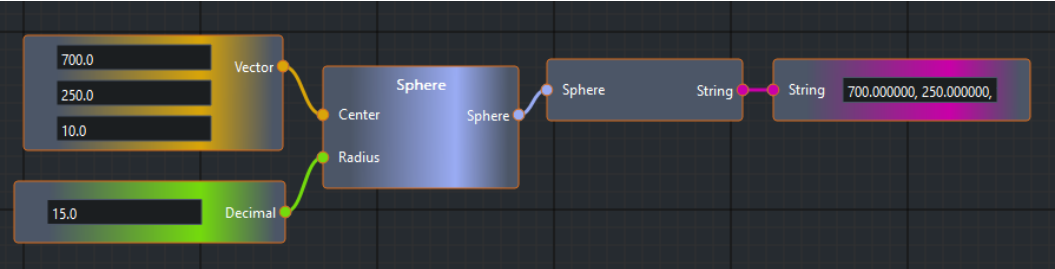
Function	Description
<p>List String Index</p>	<p>Finds one string from a list of strings. Used in conjunction with a Text File or Lucid Item Text function block and the String Split to List function block.</p> <p>Inputs:</p> <p>Strings List [Strings List]: [String Split]: [Text File] and [String Source]</p> <p>Index [Integer]: Defines which string you want to display. 0 is the first string in the list, 1 is the second string, etc.</p> <p>Output:</p> <p>String [String]</p> <p>Example:</p> 
<p>Sphere To String</p>	<p>Converts a sphere into a string. Used in conjunction with the Sphere function block (Vector Source and Decimal Source).</p> <p>Inputs:</p> <p>[Sphere]: [Vector] and [Decimal]</p> <p>Outputs:</p> <p>[String]</p> <p>Example:</p> 

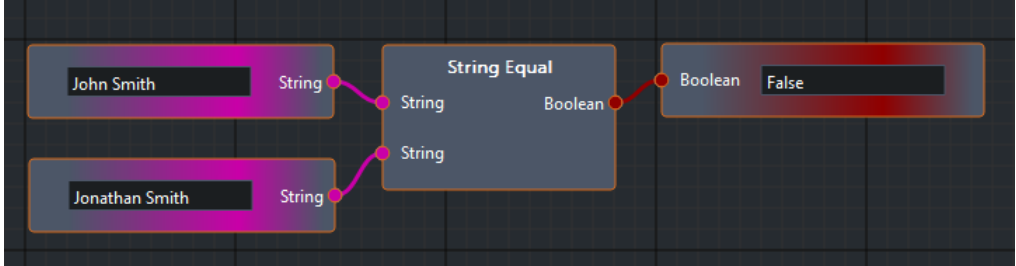
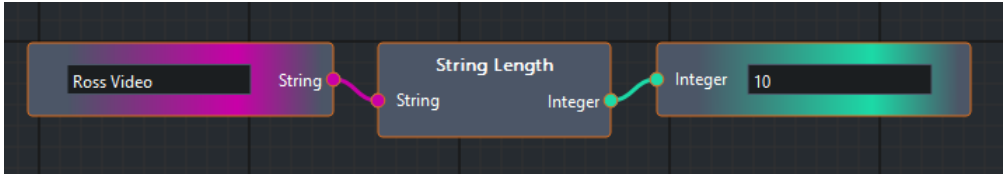
Function	Description
String Equal	<p>Compares two strings and returns True if they are the same or False if they are different. Used in conjunction with the String Source, Text File, or Lucid Item Text function blocks.</p> <p>Input: [String]</p> <p>Output: [Boolean]: True or False</p> <p>Example:</p> 
String Length	<p>Calculates the length of a string as an integer.</p> <p>Input: [String]</p> <p>Output: [Integer]</p> <p>Example:</p> 
String Result	<p>Displays the result (output) of an operation as a string.</p> <p>Input: [String]</p> <p>Output: None</p> <p>Example: See the examples for Concatenation, Integer To String, List String Index, etc.</p>
String Source	<p>The string sources (inputs) for an operation involving strings.</p> <p>Input: None</p> <p>Output: [String]</p> <p>Example: See the examples for Concatenation, Integer To String, List String Index, etc.</p>

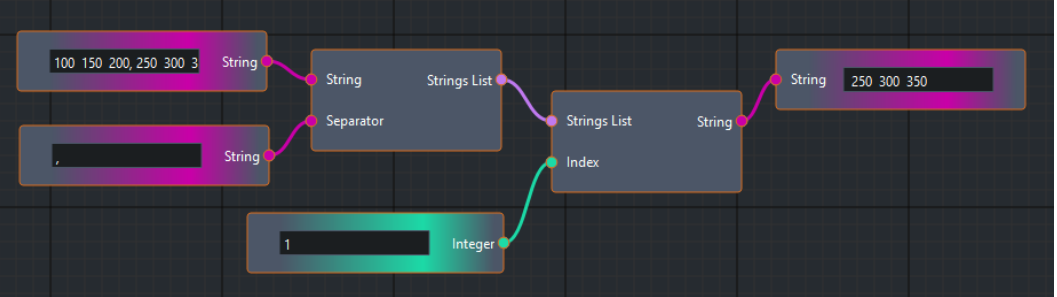
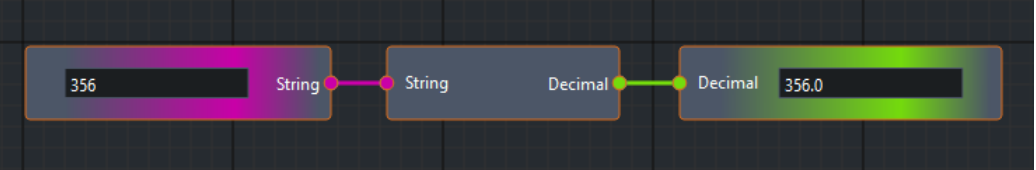
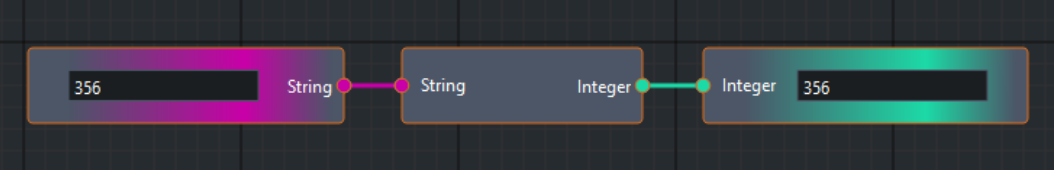
Function	Description
<p>String Split to List</p>	<p>Splits one string into multiple strings. Used in conjunction with a Text File or Lucid Item Text function block and the List String Index function block.</p> <p>Inputs:</p> <p>String [String]: String from a text file</p> <p>Separator [String]: String that identifies the character used to separate the original string.</p> <p>Output:</p> <p>Strings List [Strings List]: A list of the strings created.</p> <p>Example:</p> 
<p>String To Decimal</p>	<p>Converts a string into a decimal number.</p> <p>Input:</p> <p>[String]</p> <p>Output:</p> <p>[Decimal]</p> <p>Example:</p> 
<p>String To Integer</p>	<p>Converts a string into an integer.</p> <p>Input:</p> <p>[String]</p> <p>Output:</p> <p>[Integer]</p> <p>Example:</p> 

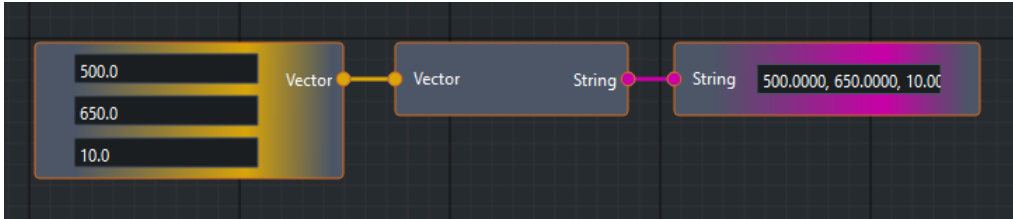
Function	Description
Vector To String	<p>Converts a 3D vector into a string.</p> <p>Input: [Vector]: x, y, z</p> <p>Output: [String]</p> <p>Example:</p> 

Tracking

The **Tracking** functions are described in the table below.

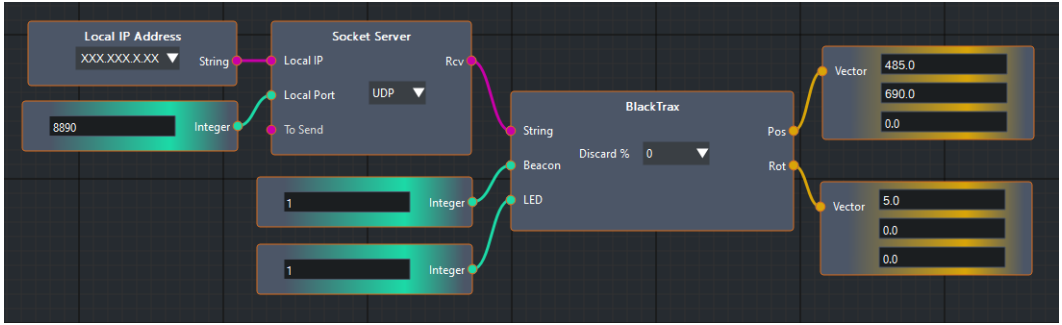
Function	Description
BlackTrax	<p>BlackTrax tracking parser that identifies the 3D position and rotation of an object by tracking a beacon attached to the object.</p> <p>Used in conjunction with the Socket Server node.</p> <p>Inputs:</p> <p>[String]</p> <p>Beacon [Integer]</p> <p>LED [Integer]</p> <p>Outputs:</p> <p>Pos (Position) [Vector]: x, y, z</p> <p>Rot (Rotation) [Vector]: x, y, z</p> <p>Example:</p> 
FreeD	<p>FreeD tracking parser that identifies the 3D position and rotation of an object.</p> <p>Used in conjunction with the Socket Server node.</p> <p>Input:</p> <p>[String]</p> <p>Outputs:</p> <p>Pos (Position) [Vector]: x, y, z</p> <p>Rot (Rotation) [Vector]: x, y, z</p> <p>Example:</p>

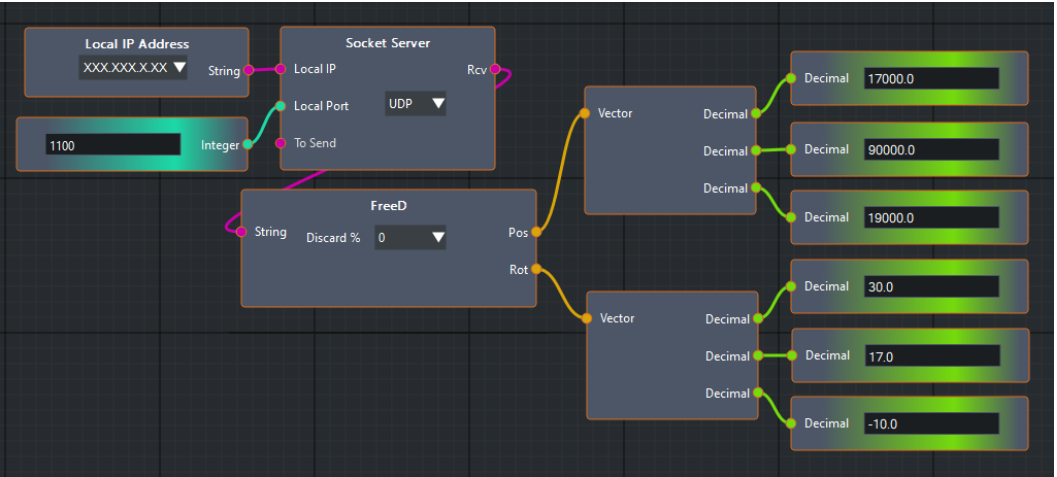
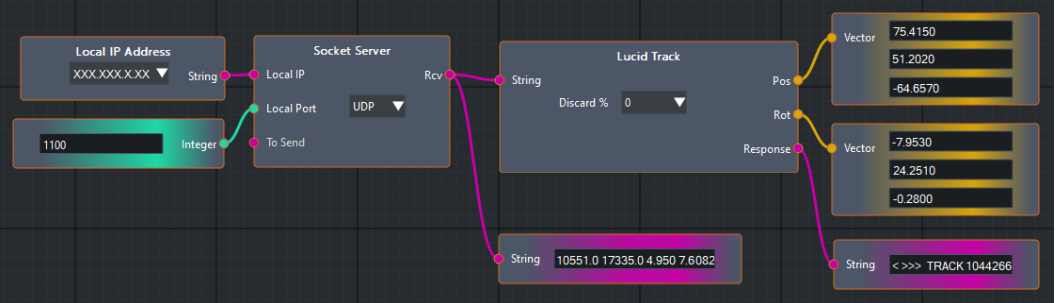
Function	Description
	 <p>The diagram shows a 'Socket Server' block with inputs for 'Local IP Address' (String, value: XXX.XXX.XXX) and 'Local Port' (Integer, value: 1100). It has a 'Local Port' dropdown set to 'UDP' and a 'To Send' input. The 'Rcv' output connects to a 'FreeD' block. The 'FreeD' block has a 'Discard %' dropdown set to '0' and outputs 'Pos' and 'Rot' as Vector types. These vectors are connected to two 'Vector' blocks, each with three 'Decimal' outputs. The top 'Vector' block outputs 17000.0, 90000.0, and 19000.0. The bottom 'Vector' block outputs 30.0, 17.0, and -10.0.</p>
<p>Lucid Track</p>	<p>Lucid Track tracking parser that identifies the 3D position and rotation of an object derived from tracking data provided by a Lucid Track. A percentage of the data can be discarded using the Discard drop-down, to reduce the number of incoming messages.</p> <p>Used in conjunction with the Socket Server function block.</p> <p>Input: [String]</p> <p>Outputs: Pos (Position) [Vector]: x, y, z Rot (Rotation) [Vector]: x, y, z Response [String]</p> <p>Example:</p>  <p>The diagram shows a 'Socket Server' block with inputs for 'Local IP Address' (String, value: XXX.XXX.XXX) and 'Local Port' (Integer, value: 1100). It has a 'Local Port' dropdown set to 'UDP' and a 'To Send' input. The 'Rcv' output connects to a 'Lucid Track' block. The 'Lucid Track' block has a 'Discard %' dropdown set to '0' and outputs 'Pos', 'Rot', and 'Response'. 'Pos' and 'Rot' are connected to two 'Vector' blocks. The top 'Vector' block outputs 75.4150, 51.2020, and -64.6570. The bottom 'Vector' block outputs -7.9530, 24.2510, and -0.2800. The 'Response' output is connected to a 'String' block with the value '<>>> TRACK 1044266'. A 'String' block also shows the input value '10551.0 17335.0 4.950 7.6082'.</p>

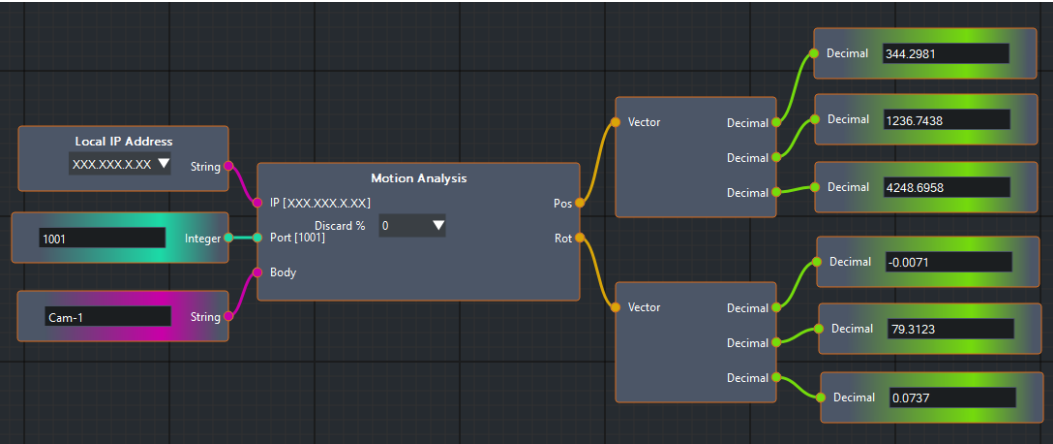
Function	Description
<p>Motion Analysis</p>	<p>Motion Analysis tracking parser that identifies the 3D position and rotation of an object and the encoder values for Zoom and Focus. It requires a connection to their Cortex server, whose IP and UDP port needs to be specified. The Motion Analysis tracking parser can track different entities, so a Body name needs to be set up to ensure it tracks the correct object.</p> <p>Inputs:</p> <p>Local IP Address [String]: Cortex IP address</p> <p>Port [Integer]: Cortex port</p> <p>Body [String]: Marker to track</p> <p>Outputs:</p> <p>Pos (Position) [Vector]: x, y, z</p> <p>Rot (Rotation) [Vector]: x, y, z</p> <p>Example:</p> 
<p>Stype</p>	<p>Stype tracking parser that identifies the 3D position and rotation of an object. A percentage of the data can be discarded using the Discard drop-down, to reduce the number of incoming messages.</p> <p>Used in conjunction with the Socket Server node.</p> <p>Inputs:</p> <p>Local IP Address [String]</p> <p>Local Port [Integer]</p> <p>To Send [String]</p> <p>Outputs</p> <p>Pos (Position) [Vector]: x, y, z</p> <p>Rot (Rotation) [Vector]: x, y, z</p> <p>Example:</p>

Function	Description

Utilities

The **Utilities** functions are described in the table below.

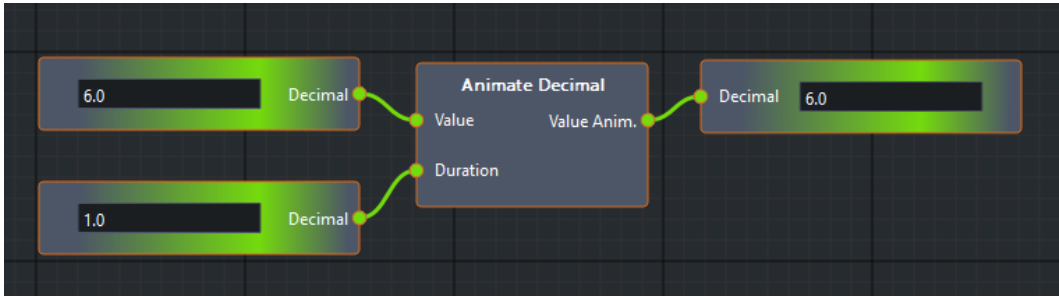
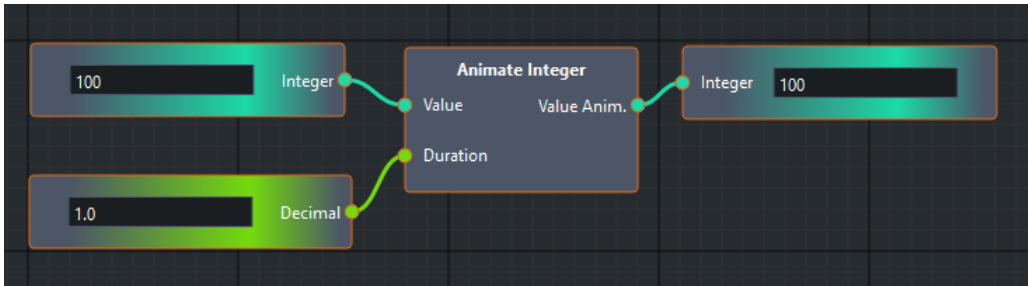
Function	Description
Animate Decimal	<p>When the Value input is changed, the output changes from its current value to the new one in the number of seconds specified in the Duration input.</p> <p>This function can be used to animate other logic blocks. However, when animating the Lucid Item Light, Lucid Item Position, Lucid Item Rotation and Lucid Item Scale logic blocks, it is better to use the Anim input on those blocks to animate them.</p> <p>Inputs:</p> <p>Value [Decimal] Duration [Decimal]</p> <p>Output:</p> <p>Value Anim. [Decimal]</p> <p>Example:</p> 
Animate Integer	<p>When the Value input is changed, the output changes from its current value to the new one in the number of seconds specified in the Duration input.</p> <p>This function can be used to animate other logic blocks. However, when animating the Lucid Item Light, Lucid Item Position, Lucid Item Rotation and Lucid Item Scale logic blocks, it is better to use the Anim input on those blocks to animate them.</p> <p>Inputs:</p> <p>Value [Integer] Duration [Decimal]</p> <p>Output:</p> <p>Value Anim. [Integer]</p> <p>Example:</p> 

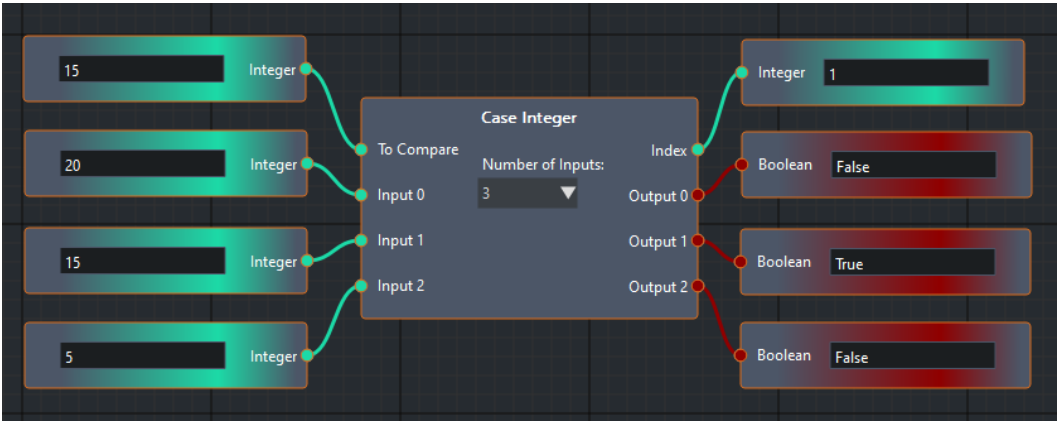
Function	Description
<p>Case Integer</p>	<p>Compares a number of integer inputs and generates the following outputs:</p> <ul style="list-style-type: none"> • the index of the first input whose value is equal to the one being compared • true for each corresponding output • false for the rest of the outputs <p>Up to 10 inputs can be selected.</p> <p>Inputs: To Compare [Integer] Inputs 0 to 9 [Integer]</p> <p>Outputs: Index [Integer] Outputs 0 to 9 [Boolean]</p> <p>Example:</p> 

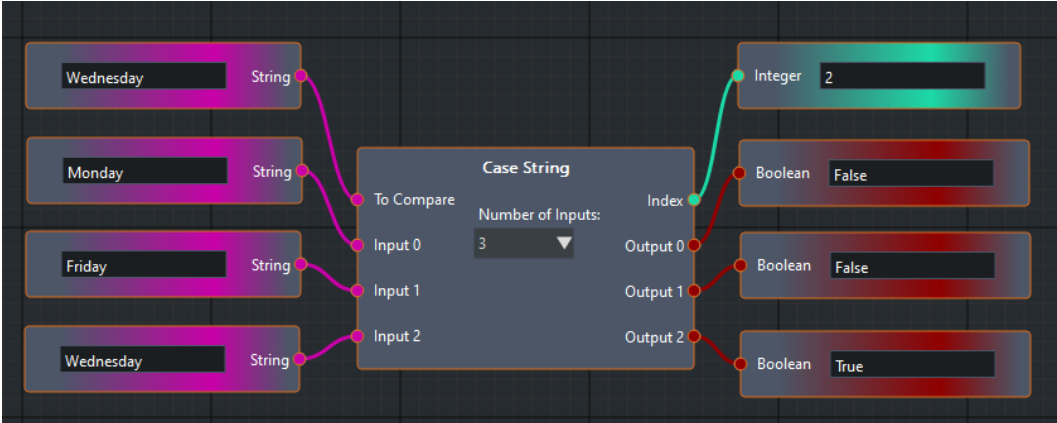
Function	Description
<p>Case String</p>	<p>Compares a number of string inputs and generates the following outputs:</p> <ul style="list-style-type: none"> • the index of the first input whose value is equal to the one being compared • true for each corresponding output • false for the rest of the outputs <p>Up to 10 inputs can be selected.</p> <p>Inputs: To Compare [String] Inputs 0 to 9 [String]</p> <p>Outputs: Index [Integer] Outputs 0 to 9 [Boolean]</p> <p>Example:</p> 
<p>Color Result</p>	<p>Outputs RGBA values. Used in conjunction with the Color Selector and Color Source function blocks.</p> <p>Input: [Color]: A color selected using RGBA values as integers or the Color Selector.</p> <p>Output: None</p> <p>Example: See the examples for the Color Selector and Color Source function blocks.</p>

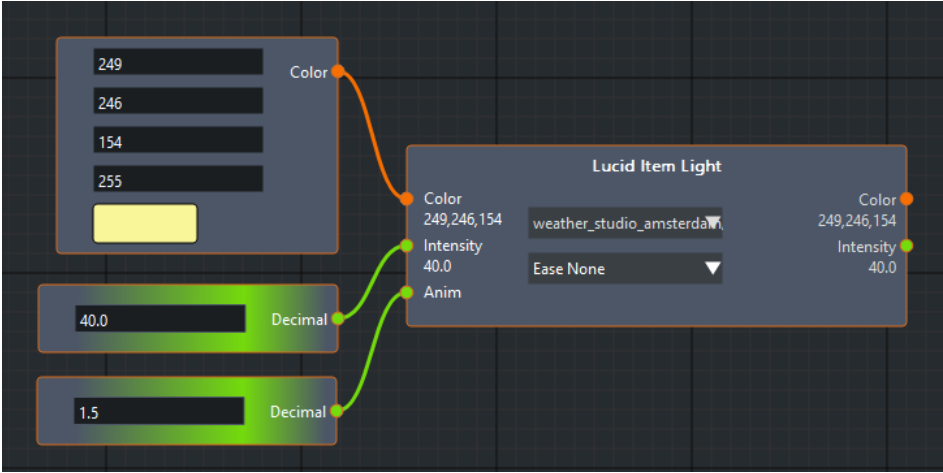
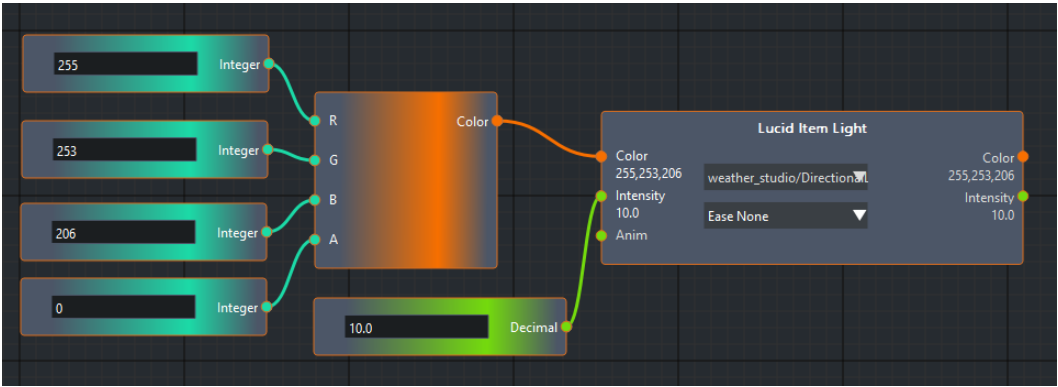
Function	Description
<p>Color Selector</p>	<p>Links to the Color Picker, where you can select the color you want to use. When you select OK, the Choose Color button changes to the color you selected and the RGBA values of the color are applied to the target (for example, a Lucid Item Light).</p> <p>Input:</p> <p>The color selected in the Color Picker.</p> <p>Output:</p> <p>RGBA values of the selected color</p> <p>Example:</p> 
<p>Color Source</p>	<p>Converts integer inputs to an RGBA color that can be applied to the target (for example a Lucid Item Light). Used in conjunction with Integer Source function blocks. Input values are between 0 and 255.</p> <p>Inputs:</p> <p>R [Integer]: Red G [Integer]: Green B [Integer]: Blue A [Integer]: Alpha</p> <p>Output:</p> <p>RGBA color result</p> <p>Example:</p> 

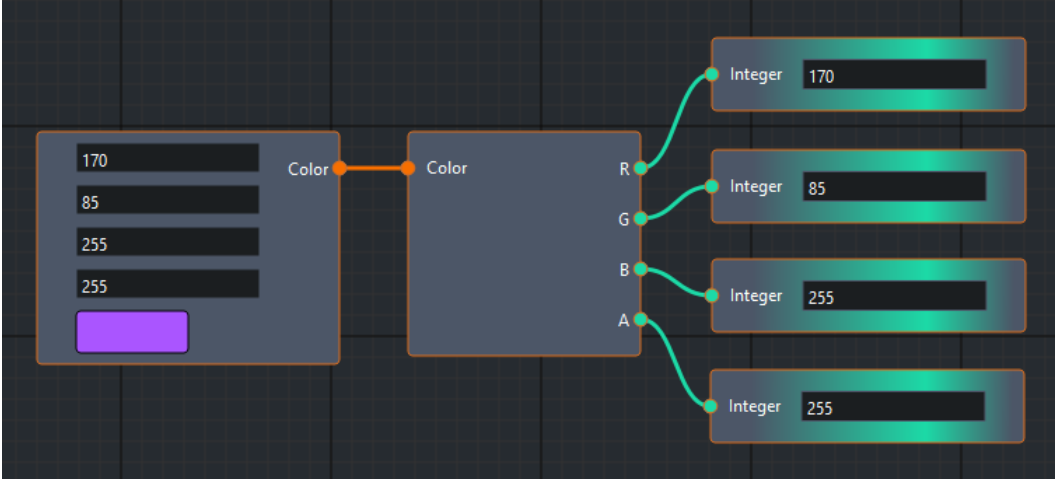
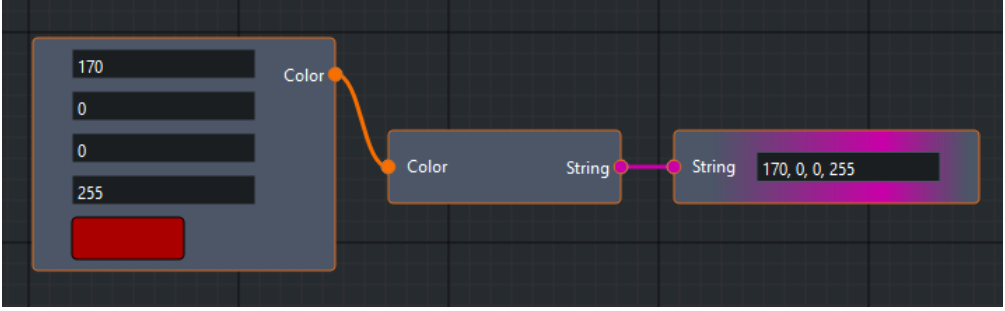
Function	Description
<p>Color Split</p>	<p>Splits a color input into four integer numbers.</p> <p>Input: [Color]: A color selected using the Color Selector.</p> <p>Outputs: R [Integer] G [Integer] B [Integer] A [Integer]</p> <p>Example:</p> 
<p>Color To String</p>	<p>Converts a color into a string.</p> <p>Input: [Color]: A color selected using RGBA values as integers or the Color Selector.</p> <p>Output: [String]</p> <p>Example:</p> 

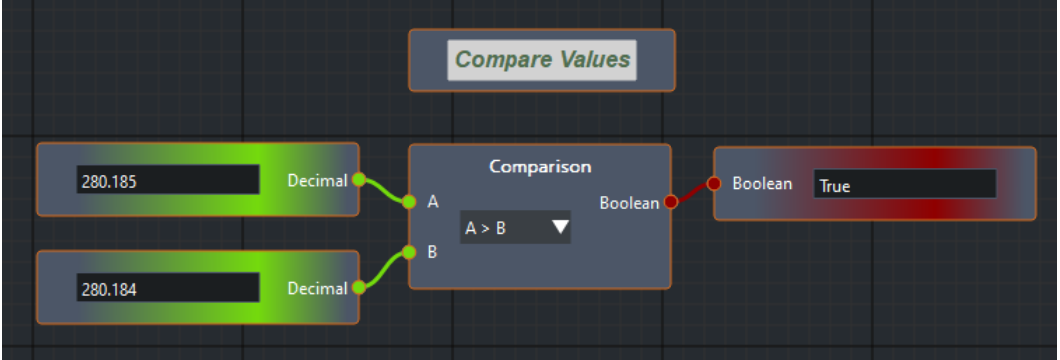
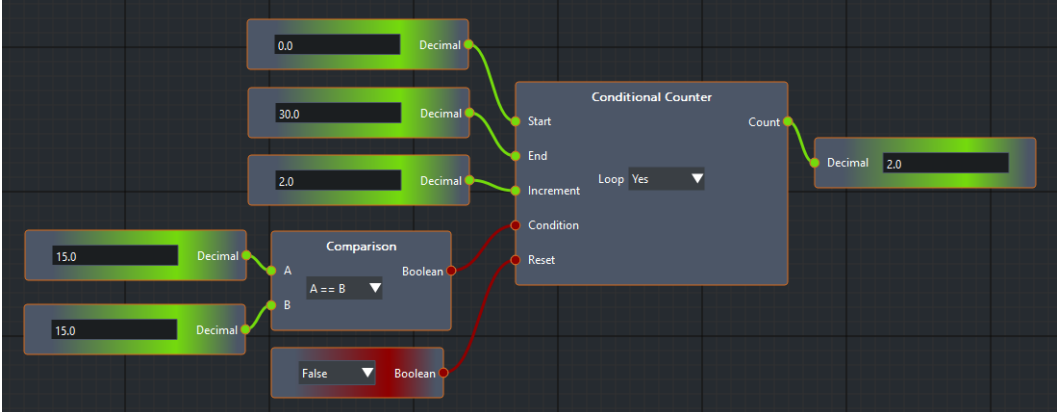
Function	Description
<p>Comment</p>	<p>Provides a means to add information to the logic graph, such as the purpose of a particular logic flow.</p> <p>Example:</p> 
<p>Conditional Counter</p>	<p>Generates a count that is incremented every time the condition changes from False to True. It includes a drop-down that allows you to select whether or not the count should loop or if it should ping-pong (increment to the End value; then decrement to the Start value and repeat).</p> <p>Inputs:</p> <p>Start [Decimal]: The number at which the count will start</p> <p>End [Decimal]: The number at which the count will end</p> <p>Increment [Decimal]: The value by which the current number will be incremented</p> <p>Condition [Boolean]: The state of an operation, either True or False</p> <p>Reset [Boolean]: Resets the counter to 0.000000 when changed from False to True</p> <p>Output:</p> <p>Count [Decimal]</p> <p>Example:</p> 

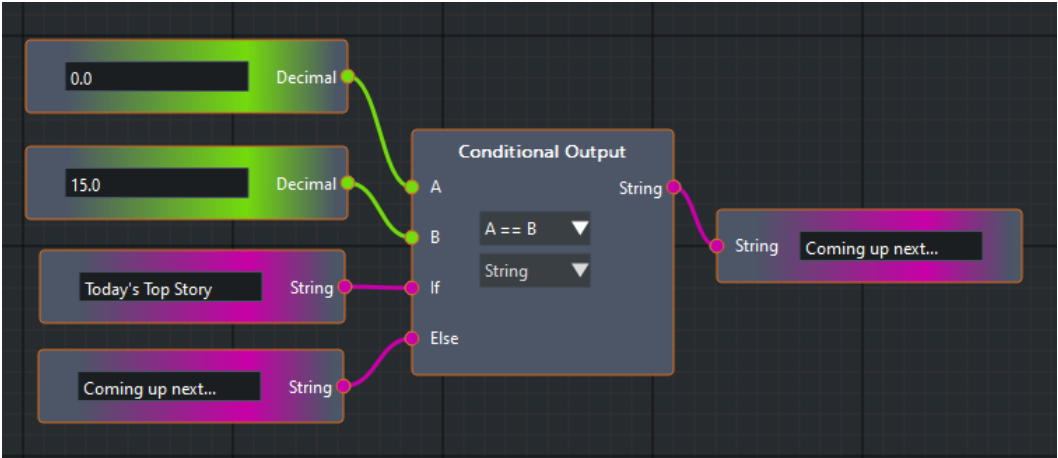
Function	Description
<p>Conditional Output</p>	<p>Compares two inputs according to the criteria selected in the first drop-down. If the comparison is True, it returns the If input value. If the comparison is False, it returns the Else input value. The If and Else inputs can be Decimals, Integers or Strings, as selected in the second drop-down. The output then changes accordingly.</p> <p>Inputs:</p> <p>A [Decimal] B [Decimal] If [Decimal], [Integer] or [String] Else [Decimal], [Integer] or [String]</p> <p>Output:</p> <p>[Decimal], [Integer] or [String]</p> <p>Example:</p> 

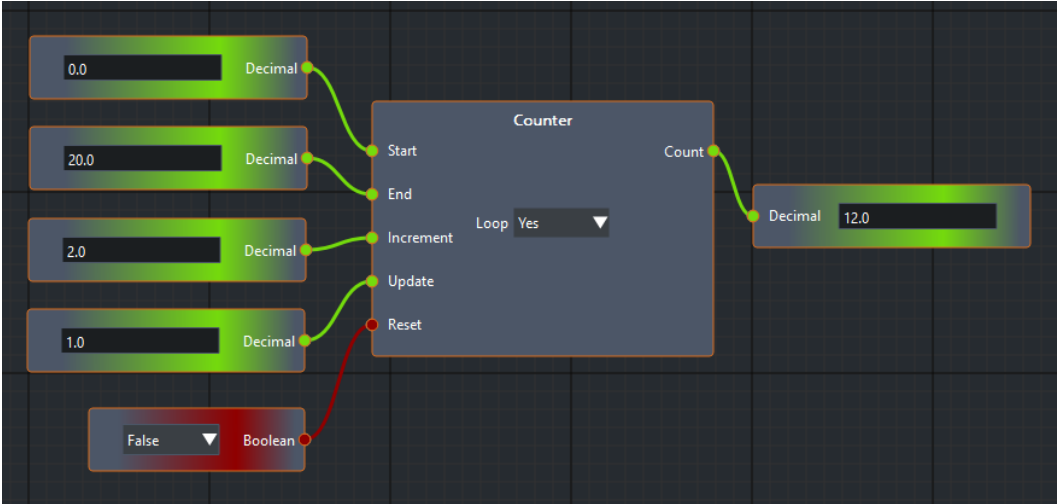
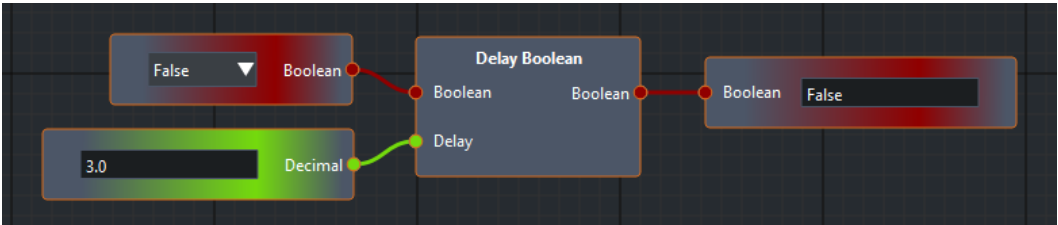
Function	Description
<p>Counter</p>	<p>Generates a count that is incremented automatically at the specified interval. It includes a drop-down that allows you to select whether or not the count should loop or if it should ping-pong (increment to the End value; then decrement to the Start value and repeat). Reset needs to be False for the counter to begin.</p> <p>Inputs:</p> <p>Start [Decimal]: The number at which the count will start</p> <p>End [Decimal]: The number at which the count will end</p> <p>Increment [Decimal]: The value by which the current number will be incremented</p> <p>Update [Decimal]: The interval (in seconds) at which the counter will be incremented</p> <p>Reset [Boolean]: Resets the counter to 0.000000 when changed from False to True</p> <p>Output:</p> <p>[Decimal]</p> <p>Example:</p> 
<p>Delay Boolean</p>	<p>Generates an output of the same type after a delay of the specified decimal input.</p> <p>Inputs:</p> <p>[Boolean]</p> <p>Delay [Decimal]</p> <p>Output:</p> <p>[Boolean]</p> <p>Example:</p> 

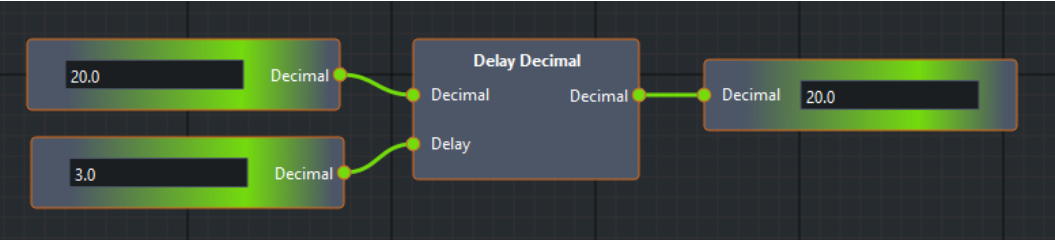
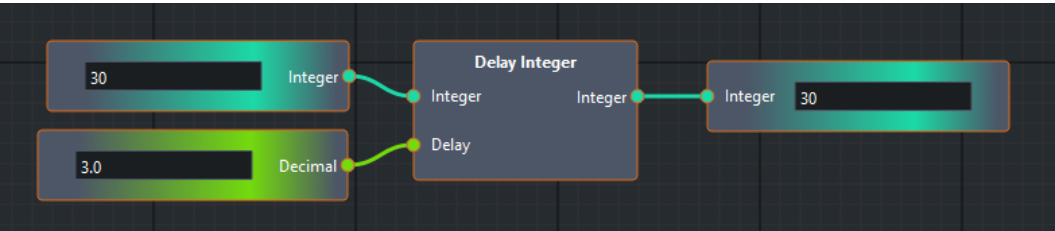
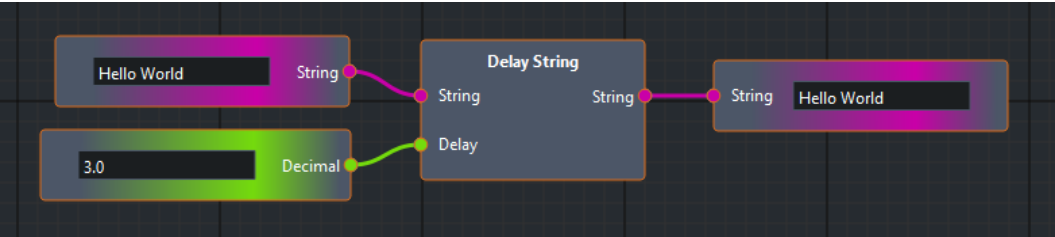
Function	Description
<p>Delay Decimal</p>	<p>Generates an output of the same type after a delay of the specified decimal input.</p> <p>Inputs: [Decimal] Delay [Decimal]</p> <p>Output: [Decimal]</p> <p>Example:</p> 
<p>Delay Integer</p>	<p>Generates an output of the same type after a delay of the specified decimal input.</p> <p>Inputs: [Integer] Delay [Decimal]</p> <p>Output: [Integer]</p> <p>Example:</p> 
<p>Delay String</p>	<p>Generates an output of the same type after a delay of the specified decimal input.</p> <p>Inputs: [String] Delay [Decimal]</p> <p>Output: [String]</p> <p>Example:</p> 

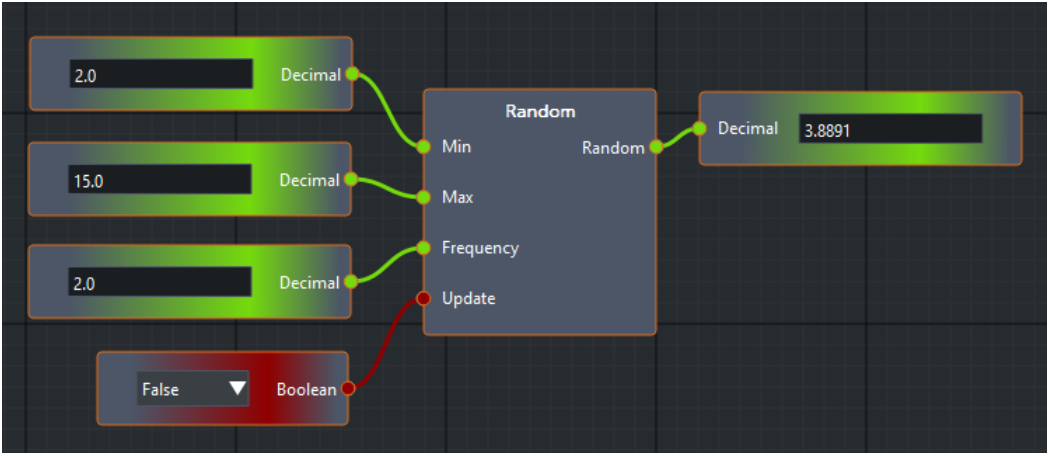
Function	Description
<p>Random</p>	<p>Generates a random number periodically if Frequency is set or manually when Update changes.</p> <p>Inputs:</p> <p>Min [Decimal]: Lowest number that can be generated</p> <p>Max [Decimal]: Highest number that can be generated</p> <p>Frequency [Decimal]: Interval (in seconds) at which a new random number is generated (if set)</p> <p>Update [Boolean]: When changed from True to False or vice versa, a new number is generated.</p> <p>Output:</p> <p>Random [Decimal]: Generated random value</p> <p>Example:</p> 
<p>Stopwatch Boolean</p>	<p>Returns the time (in seconds) between a change in the Start input and a change in the Stop input (in that order).</p> <p>Inputs:</p> <p>Start [Boolean]: True or False</p> <p>Stop [Boolean]: True or False</p> <p>Reset [Boolean]: When changed from False to True, the time is reset to 0.000000.</p> <p>Output:</p> <p>Time [Decimal]</p> <p>Example:</p>

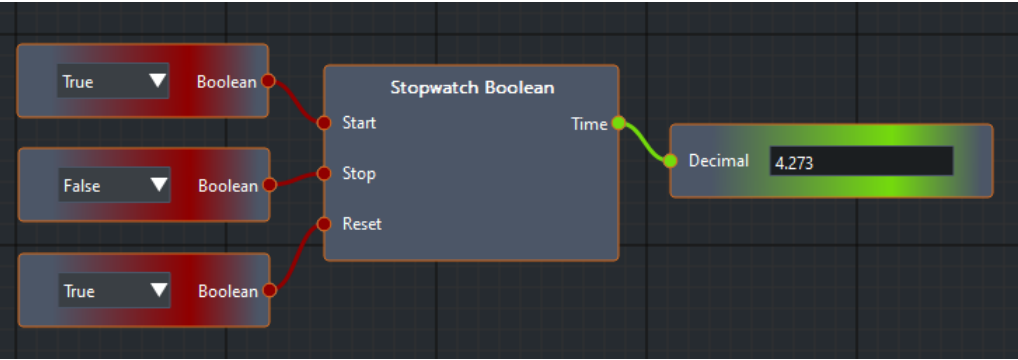
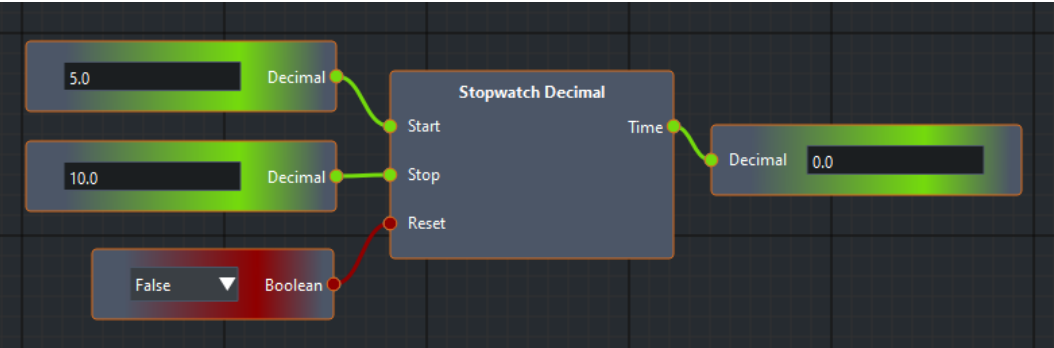
Function	Description
	
<p>Stopwatch Decimal</p>	<p>Returns the time (in seconds) between a change in the Start input and a change in the Stop input (in that order).</p> <p>Inputs:</p> <p>Start [Decimal]</p> <p>Stop [Decimal]</p> <p>Reset [Boolean]: When changed from False to True, the time is reset to 0.</p> <p>Output:</p> <p>Time [Decimal]</p> <p>Example:</p> 

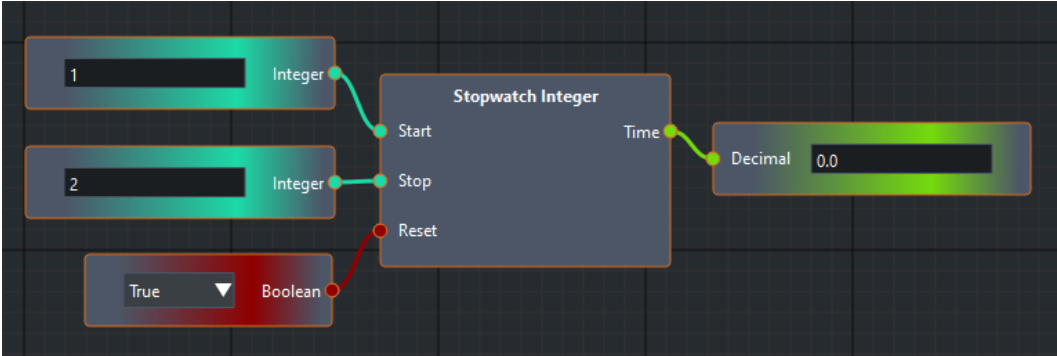
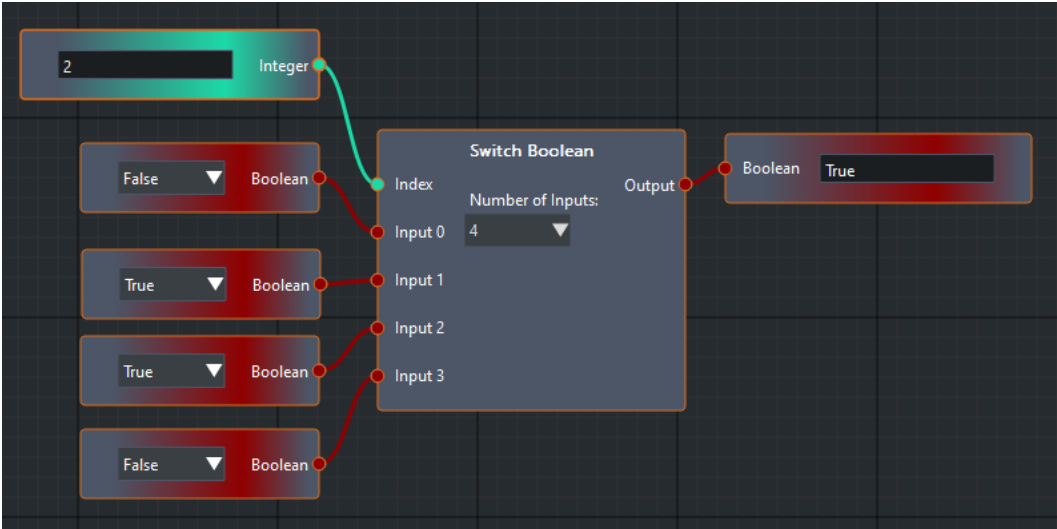
Function	Description
<p>Stopwatch Integer</p>	<p>Returns the time (in seconds) between a change in the Start input and a change in the Stop input (in that order).</p> <p>Inputs:</p> <p>Start [Integer]</p> <p>Stop [Integer]</p> <p>Reset [Boolean]: When changed from False to True, the time is reset to 0.</p> <p>Output:</p> <p>Time [Decimal]</p> <p>Example:</p> 
<p>Switch Boolean</p>	<p>Returns the Boolean output (True or False) as indicated by the Index value. Up to 10 inputs can be selected.</p> <p>Inputs:</p> <p>Index [Integer]</p> <p>Input 0 [Boolean]</p> <p>Output:</p> <p>[Boolean]</p> <p>Example:</p> 

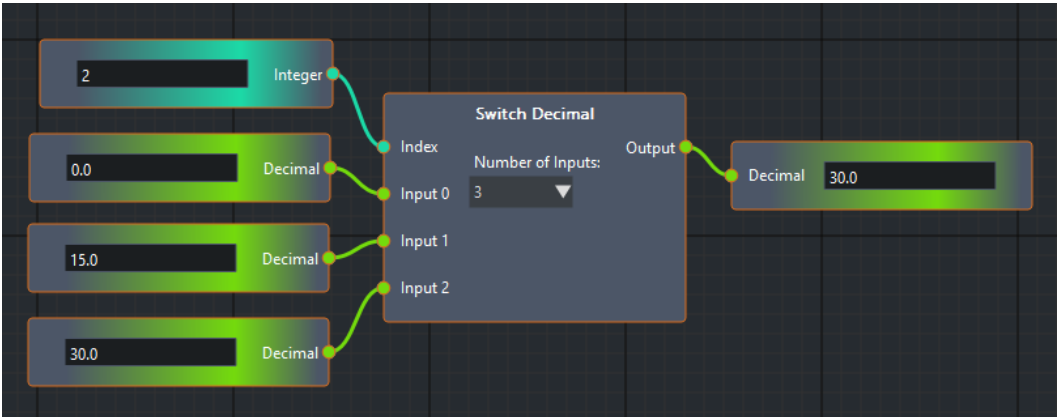
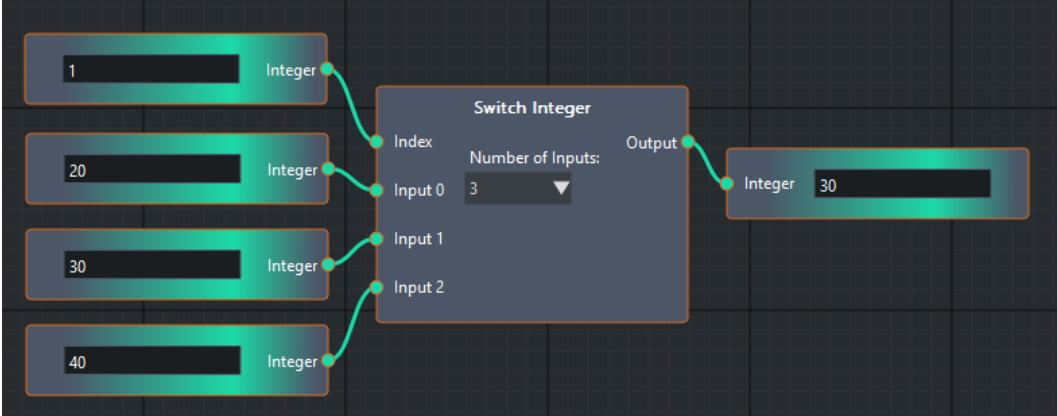
Function	Description
<p>Switch Decimal</p>	<p>Returns the decimal output indicated by the Index value. Up to 10 inputs can be selected.</p> <p>Inputs: Index [Integer] Input 0 [Decimal]</p> <p>Output: [Decimal]</p> <p>Example:</p> 
<p>Switch Integer</p>	<p>Returns the integer output indicated by the Index value. Up to 10 inputs can be selected.</p> <p>Inputs: Index [Integer] Input 0 [Integer]</p> <p>Output: [Integer]</p> <p>Example:</p> 

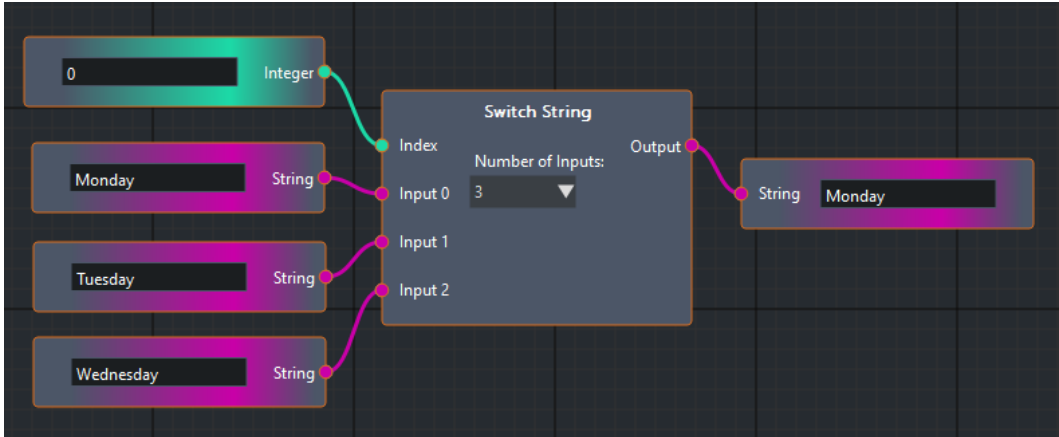
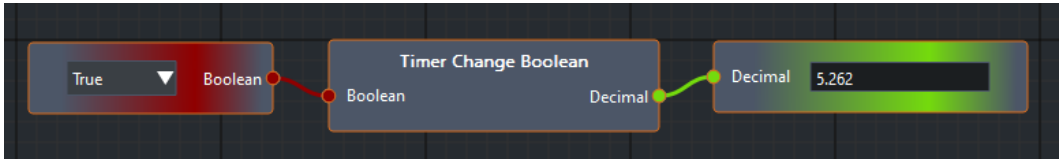
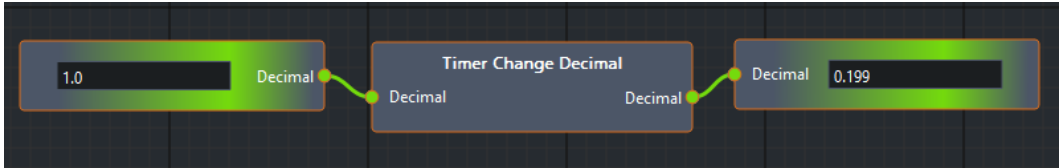
Function	Description
Switch String	<p>Returns the string output indicated by the Index value. Up to 10 inputs can be selected.</p> <p>Inputs: Index [Integer] Input 0 [String]</p> <p>Output: [String]</p> <p>Example:</p> 
Timer Change Boolean	<p>Returns the time (in seconds) between the last two changes in a Boolean input.</p> <p>Input: [Boolean]</p> <p>Output: [Decimal]</p> <p>Example:</p> 
Timer Change Decimal	<p>Returns the time (in seconds) between the last two changes in a decimal input.</p> <p>Input: [Decimal]</p> <p>Output: [Decimal]</p> <p>Example:</p> 

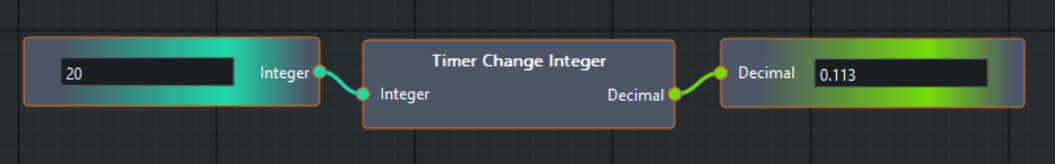
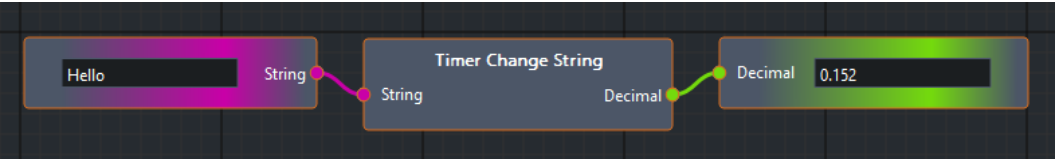
Function	Description
<p>Timer Change Integer</p>	<p>Returns the time (in seconds) between the last two changes in an integer input.</p> <p>Input: [Integer]</p> <p>Output: [Decimal]</p> <p>Example:</p> 
<p>Timer Change String</p>	<p>Returns the time (in seconds) between the last two changes in a string input.</p> <p>Input: [String]</p> <p>Output: [Decimal]</p> <p>Example:</p> 
<p>Units Converter</p>	<p>Converts a decimal input to an output of the unit type selected in the drop-down.</p> <p>Input: [Decimal]</p> <p>Output: [Decimal]</p> <p>Example:</p>

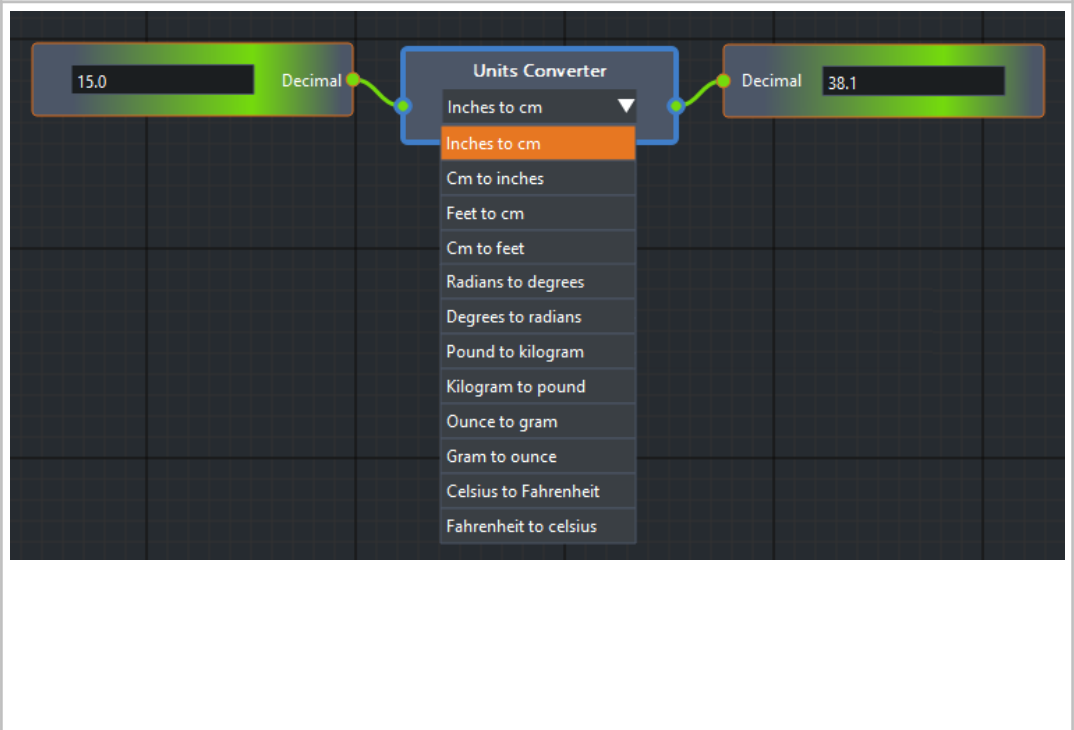
Function	Description
	 <p>The screenshot shows a 'Units Converter' widget in a flowchart environment. The widget has two input ports, both labeled 'Decimal'. The left input port contains the value '15.0' and the right input port contains '38.1'. A dropdown menu is open from the top of the widget, listing various conversion options. The first option, 'Inches to cm', is highlighted in orange. Other options include 'Cm to inches', 'Feet to cm', 'Cm to feet', 'Radians to degrees', 'Degrees to radians', 'Pound to kilogram', 'Kilogram to pound', 'Ounce to gram', 'Gram to ounce', 'Celsius to Fahrenheit', and 'Fahrenheit to celsius'.</p>

Web

Many devices are configurable from their own web pages. The Web panel is an interactive means of configuring different devices via a Web server or for visiting a web page directly from within Lucid Studio. For example Furio's camera tracking information can be configured by entering its IP address into a web browser.

You can also add frequently visited web pages to your **Favorites** for quick access.

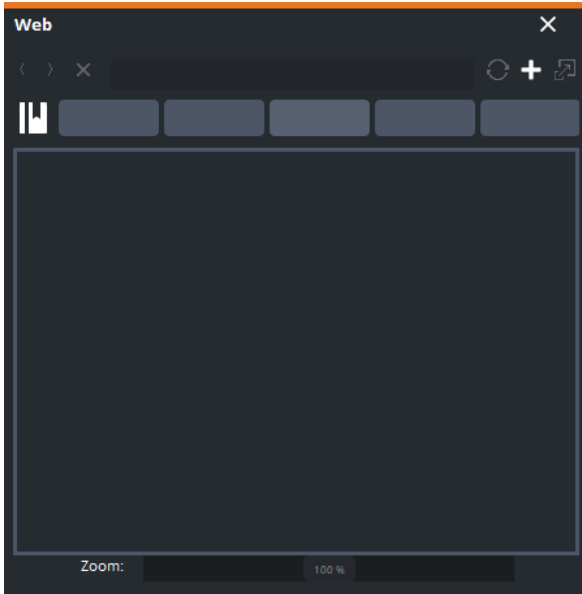

Web Panel

To add a web page to the Web panel:

1. Select the **+** icon to the right of the **Search** bar to open a new tab.
2. Then enter the **IP** address or **URL** of the web page in the **Search** bar.

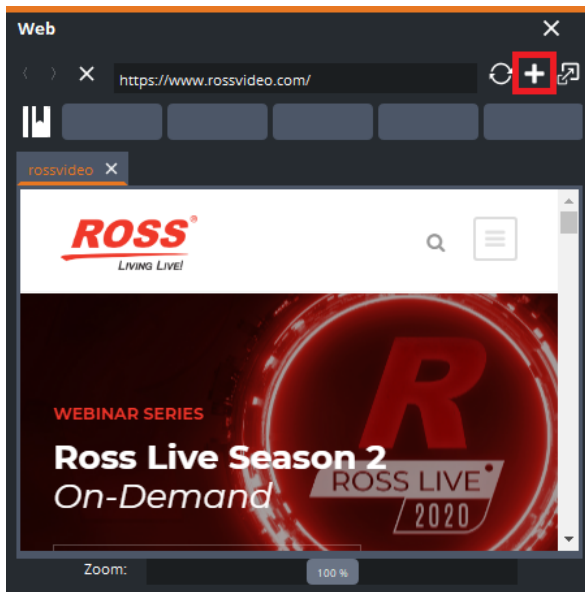

Add Web Page

3. Press **Enter**.

The name of the web page is added to the tab and the site is displayed.

4. Use the **Zoom** slider at the bottom of the panel to adjust the zoom size percentage of the tab..

5. Select the **Full-panel**  icon in the top-right corner to display the site without the tabs and URL field.

The web page title appears in the top-right corner of the panel.

To remove a web page from the Web panel:

- Select the **X** in the corner of the tab of the web page you want to remove.

To add a web page to your favorites:

1. Select on the tab of the web page you want to add to your favorites.

2. Then select the  icon to the left of the **Favorites** bookmarks.

3. **The Web Favorites** pane opens.

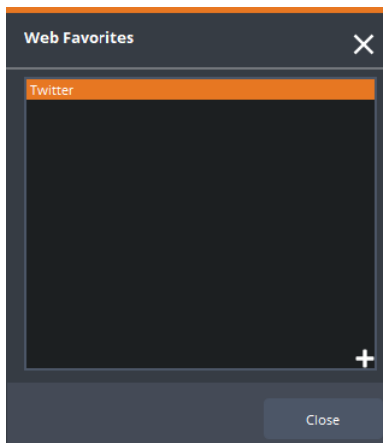

Web Favorites

4. Select the **+** icon at the bottom of the pane.

The **New Favorite** window opens.

5. In the **New Favorite** window, enter a name for the web page or leave the default name.

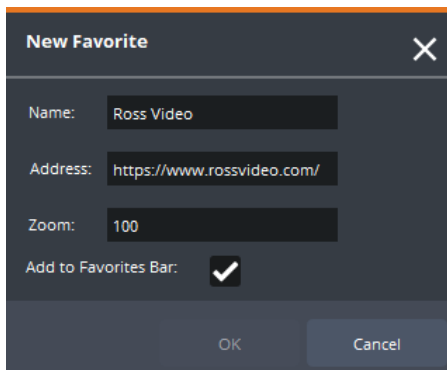

New Favorite Web Page

6. Adjust the **Zoom** level (optional).
7. Select the **Add to Favorites Bar** checkbox and select **OK**.
8. Then select **Close** to exit the **Web Favorites** pane.

To edit a favorite web page:

1. Select the  icon to the left of the **Favorites** bookmarks.
The **Web Favorites** pane opens.
2. Right-click the web page you want to edit and from the context menu, select **Edit**.
3. In the **Edit Favorite** window, edit the **Name**, **Address** or **Zoom** level of the web page and select **OK**.
4. Then select **Close** to exit the **Web Favorites** pane.

To delete a favorite web page:

1. Select the  icon to the left of the **Favorites** bookmarks.
The **Web Favorites** pane opens.
2. Right-click the web page you want to delete and from the context menu, select **Delete**.

Chroma

The **Chroma** panel is used with Voyager renderers only.

You can use the Chroma panel to adjust the Chroma **Keyer** settings of a live camera feed to achieve the most realistic composited image and create and save presets that can be recalled when necessary.

The parameters in this panel correspond to those found in the VoyagerComposite actor **Details** tab in the **Chroma Keyer** section.

It is helpful to have the Voyager renderer open as well, so that you will be able to see a larger version of the feed, as you adjust the settings.

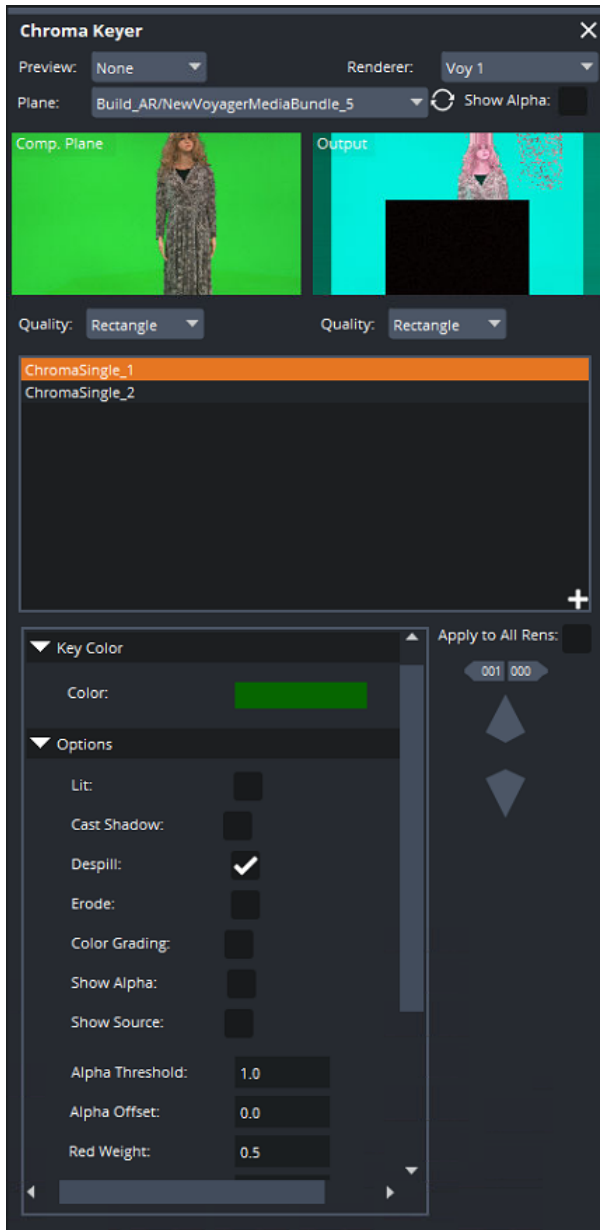

Chroma Panel

Before you begin configuring the image preview:

- Be aware that enabling the **Preview** can impact performance, so you should only use it while setting up the project. Make sure the **Preview** option is set to None when you are ready to play your project.
- From the **Renderer** drop-down, select which Voyager renderer you will use to configure the chroma keyer (if there is only one renderer connected, it will be selected automatically).
- Select the **Show Alpha** checkbox, if you want to see the alpha image as well.
Viewing the alpha image can help detect areas that need to be corrected.

To configure the image preview(s):

1. From the **Preview** drop-down, select whether you want to preview the composite plane, the output or both (or none).
2. From the **Plane** drop-down, select which composite plane is being keyed (if there is only one, it will be selected automatically).
3. Select the pane(s) corresponding to the selection you made in Step 1 to begin capturing the image.
4. Beneath each pane, from the **Quality** drop-down, select the frame rate at which you want to preview the image.

To adjust the key color of the chroma keyer:

1. In the lower half of the **Chroma** panel, select the **Key Color** arrow.
2. Then select the colored rectangle to open the **Key Color** editor.

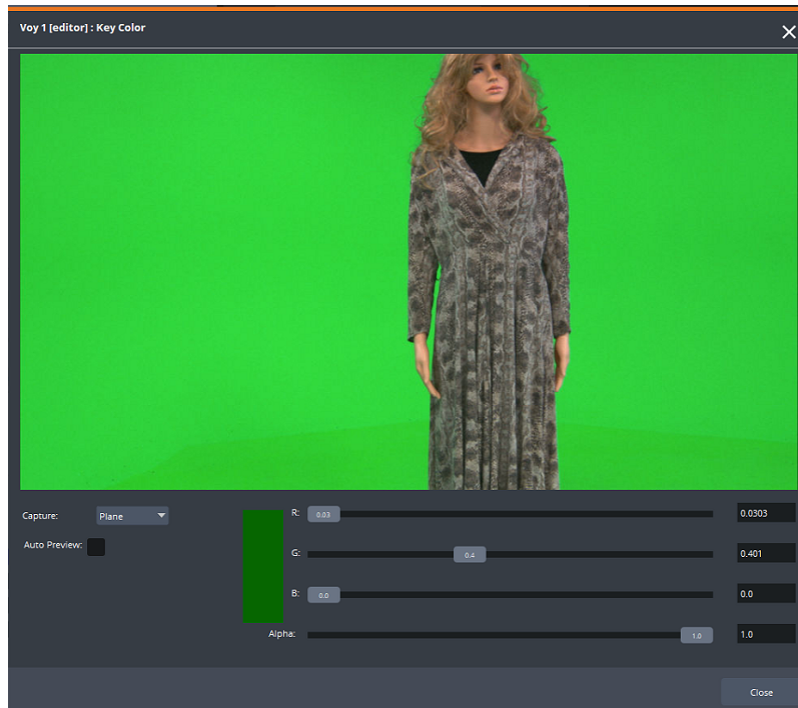

Key Color Editor

- In the **Key Color** editor, select the green rectangle to open the color picker and adjust the slider to a color that's as close as possible to the shade of green closest to your subject.

Alternatively, you can use the sliders in the **Key Color** editor to adjust the color.

- Close the color picker and/or the **Key Color** editor and select **Options**.
- Select the **Options** arrow and select the checkboxes to enable the options you want to use.

Some options have additional parameters that you can see and adjust when you scroll down to that option. The options and parameters are described in the following table.

Option	Description
Lit	The subject will be lit by the virtual lights in the scene (no parameters).
Cast Shadow	When Lit and Cast Shadow are both enabled, the subject will cast a shadow appropriately based on where the virtual light is located (no parameters).
Despill	<p>If the green screen is causing a reflection on the subject, Despill will remove most, if not all of it.</p> <p>Parameters</p> <p>Despill Hue Range – selects the hue of the reflection falling on the subject.</p> <p>Despill Amount – adjusts the amount of the selected hue that will be visible.</p> <p>Despill Method – selects whether to adjust the Despill Hue Range and Despill Amount automatically (Auto) or manually (Hue).</p>
Erode	Smooths the pixels at the edge of the key.
Color Grading	<p>Fine tunes the colors of the subject.</p> <p>Parameters</p> <p>Brightness – adjusts the lightness/darkness of the main colors.</p> <p>Contrast – increases/decreases the distinction between light and dark areas.</p> <p>Gain – adjusts the brightness/darkness of the highlights.</p> <p>Gamma – optimizes the brightness and contrast in the midtones.</p> <p>Hue Shift – modifies the image hue by shifting the HSV Hue component along the color circle by the specified number of degrees (0.0 - 360.0).</p> <p>Lift – adjusts the brightness/darkness of all parts of the image but particularly the darker areas.</p> <p>Saturation – increases/decreases the purity of the colors.</p>
Show Alpha	Shows the alpha channel of the image. This needs to be selected in order to see the effects of changes made to the Alpha Threshold and Alpha Offset parameters.
Show Source	Shows the source file before it gets passed to the keyer.
Alpha Threshold	Adjusts the fine details, such as the hair of the subject.
Alpha Offset	Adjusts the white area in the alpha image to remove any transparent or semi-transparent spots.
Red Weight	Removes any red that appears where it shouldn't.
Blue Weight	Removes any blue that appears where it shouldn't.

Option	Description
Clip Black	With Clip White , adjusts the alpha image to achieve a background that is completely black and a subject that is completely white.
Clip White	With Clip Black , adjusts the alpha image to achieve a background that is completely black and a subject that is completely white.

- Use the **Value Change Control** and **Up/down Arrows** to adjust the parameters by the selected increment.

Value Change Control

The **Value Change Control** determines the increment value by which change is applied for each click of the arrows.

To use it, select the parameter whose value you want to change, select the desired increment (i.e. how much change should occur for each click of an arrow button - ranging from 0.001 to 100) and then select the up or down arrow to make the change.

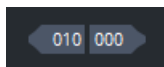

Value Change Control

Up/Down Arrows

These arrows control the value of the parameters.

The label for the selected parameter will be displayed between the up/down arrows. If for example, you select the **Alpha Offset** field, the label **A.Offset** will be displayed between the arrows.

When selecting an up or down arrow, holding the left mouse button down and moving the mouse in any direction will increase or decrease (depending on the arrow) the value more quickly.

- If you want to apply any changes made to the color settings to all renderers in the system, select the **Apply to All Rens** checkbox.

Presets

Once you've achieved a satisfactory chroma key, you can save your settings in a **Preset** for later recall. This might be useful if you want to configure the chroma key for different lighting conditions, different camera views, different outfits worn by the talent, etc.

To create a preset:

1. Select on the **+** sign in the bottom-right corner of the **Presets** pane.

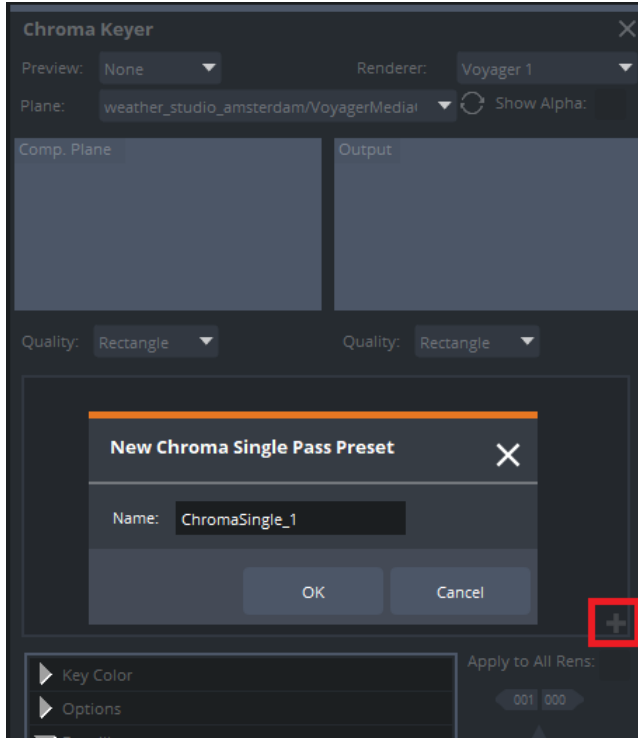

Create New Preset

The **New Chroma Single Pass Preset** window opens.

2. In the **New Chroma Single Pass Preset** window, enter a name for the preset and select **OK**.

The preset is saved and appears in the **Presets** pane.

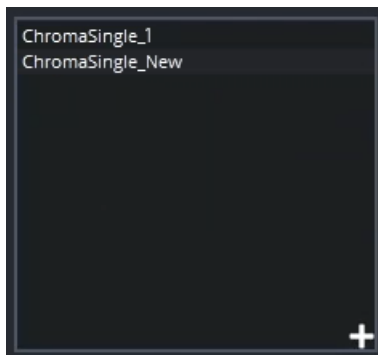

Presets Pane

To recall a preset:

- Double-click the preset.

If **Apply to All Rens** is selected, the preset will be restored to the plane for which it was saved and applied to all renderers.

Color Correction

The **Color Correction** panel is used with Voyager renderers only.

You can use the **Color Correction** panel to adjust the color of objects in the virtual camera output. The parameters in this panel correspond to those found in the **VoyagerCameraActor Details** tab in the **Post Process > Color Grading** section.

You can also save and recall preset color corrections.

When you adjust the colors on one HDR display, the correction will look the same on all displays to which the image is being outputted.

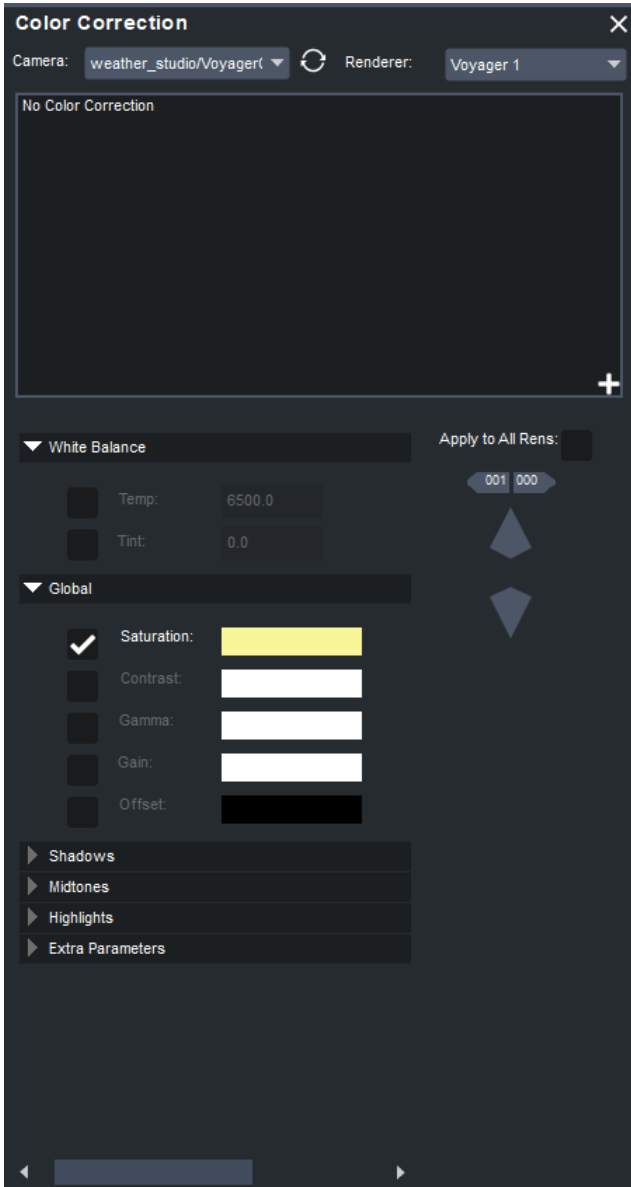

Color Correction Panel

To use the Color Correction panel:

1. From the **Camera** drop-down, select the camera actor whose image capture requires color adjustment.
If there is only one camera, it will be automatically selected.
2. From the **Renderer** drop-down, select the renderer that contains the camera actor.
If there is only one renderer, it will be automatically selected.
3. Select on the arrow beside each of the options to expand them and view their parameters.
4. Then adjust the parameters as necessary to achieve the best color, according to the table below:
5. For the **White Balance** option and **Extra** options you can use the **Value Change Control** and **Up/Down Arrows** to adjust the values.

- **Value Change Control**

The **Value Change Control** determines the increment by which change is applied for each click of the **Up/Down** arrows.

To use it, select the input field whose value you want to change, select the desired scale value (i.e., how much change should occur for each click of an arrow button - ranging from **0.001** to **100**), and then select the up or down arrow to make the change.

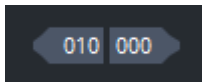

Value Change Control

- **Up/Down Arrows**



Up/Down Arrows

For the remaining settings, select the checkbox to the left of the parameter you want to adjust and then double-click the color bar to the right of the parameter to open the color controls.

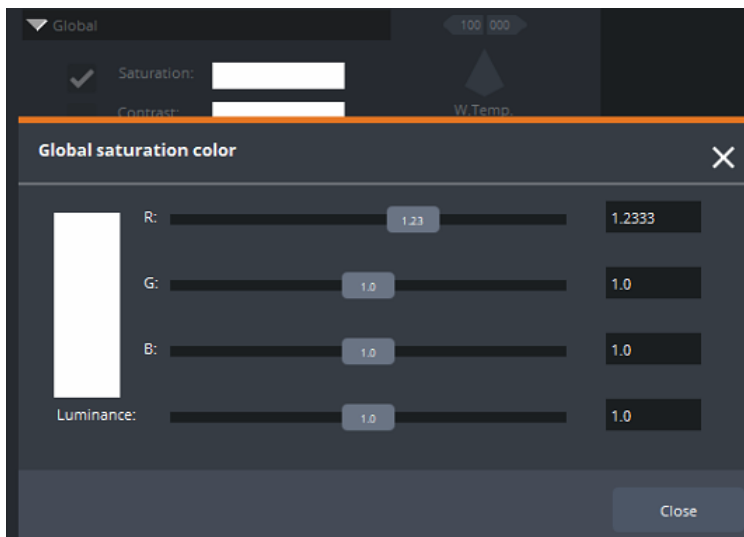

Color Controls

- In the **Color Control** window, select the color panel on the left to open a color picker and select the color you want to adjust, then move the **R**, **G**, **B** and **Luminance** sliders to make the adjustment.

The options and parameters are described in the following table. You can apply adjustments to all parts of the image at once using the **Global** options or apply adjustments to individual elements using the **Shadows**, **Midtones** and **Highlights** options.

Option	Description
White Balance	<p>Adjusts the colors in the scene so that whites appear truly white, allowing for other colors to be correctly lit under the lighting present in the scene.</p> <p>Select the parameter field and then use the arrows to increase or decrease the value. You can change the increments by which the value is changed in the Value Change Control.</p> <p>Temp — Increasing the temperature value makes the colors warmer (more yellow) while decreasing the temperature value makes the colors cooler (more blue).</p> <p>Tint — Increasing the tint value adds more magenta while decreasing the tint value adds more green. Adjust in small increments of 001 after setting the white balance.</p>
Global	<p>Adjusts the parameters of all areas in the image.</p> <p>Saturation — Increasing the saturation value makes the colors more like their purest forms (red, green, blue), while decreasing the saturation value makes the colors appear more gray or washed-out.</p> <p>Contrast — Increasing the contrast value tightens the highlights and darkens the overall image, while decreasing the contrast value removes highlights and lightens the image, resulting in a washed-out appearance.</p> <p>Gamma — Adjusts the luminance intensity in the mid-tones. Increasing the gamma value will make the image darker while decreasing the gamma value will make the image appear washed-out.</p> <p>Gain — Adjusts the luminance intensity of the highlights. Increasing the gain value makes the highlights brighter while decreasing the gain value makes the highlights darker.</p> <p>Offset — Adjusts the luminance intensity of the image's shadows. Increasing the offset value makes the shadows darker while decreasing the offset makes the shadows more gray.</p>
Shadows	<p>Adjusts the parameters of the shadows in the image.</p> <p>Saturation — Increasing the saturation value makes the colors more like their purest forms (red, green, blue), while decreasing the saturation value makes the colors appear more gray or washed-out.</p> <p>Contrast — Increasing the contrast value tightens the highlights and darkens the overall image, while decreasing the contrast value removes highlights and lightens the image, resulting in a washed-out appearance.</p> <p>Gamma — Adjusts the luminance intensity in the midtones. Increasing the gamma value will make the image darker while decreasing the gamma value will make the image appear washed-out.</p> <p>Gain — Adjusts the luminance intensity of the highlights. Increasing the gain value makes the highlights brighter while decreasing the gain value makes the highlights darker.</p> <p>Offset — Adjusts the luminance intensity of the image's shadows. Increasing the offset value makes the shadows darker while decreasing the offset makes the shadows more gray.</p>

Option	Description
	<p>Max — Multiplies the adjustments made in the Shadows section.</p>
<p>Midtones</p>	<p>Adjusts the parameters of the mid-tones in the image.</p> <p>Saturation — Increasing the saturation value makes the colors more like their purest forms (red, green, blue), while decreasing the saturation value makes the colors appear more gray or washed-out.</p> <p>Contrast — Increasing the contrast value tightens the highlights and darkens the overall image, while decreasing the contrast value removes highlights and lightens the image, resulting in a washed-out appearance.</p> <p>Gamma — Adjusts the luminance intensity in the mid-tones. Increasing the gamma value will make the image darker while decreasing the gamma value will make the image appear washed-out.</p> <p>Gain — Adjusts the luminance intensity of the highlights. Increasing the gain value makes the highlights brighter while decreasing the gain value makes the highlights darker.</p> <p>Offset — Adjusts the luminance intensity of the image’s shadows. Increasing the offset value makes the shadows darker while decreasing the offset makes the shadows more gray.</p>
<p>Highlights</p>	<p>Adjusts the parameters of the highlights in the image.</p> <p>Saturation — Increasing the saturation value makes the colors more like their purest forms (red, green, blue), while decreasing the saturation value makes the colors appear more gray or washed-out.</p> <p>Contrast — Increasing the contrast value tightens the highlights and darkens the overall image, while decreasing the contrast value removes highlights and lightens the image, resulting in a washed-out appearance.</p> <p>Gamma — Adjusts the luminance intensity in the mid-tones. Increasing the gamma value will make the image darker while decreasing the gamma value will make the image appear washed-out.</p> <p>Gain — Adjusts the luminance intensity of the highlights. Increasing the gain value makes the highlights brighter while decreasing the gain value makes the highlights darker.</p> <p>Offset — Adjusts the luminance intensity of the image’s shadows. Increasing the offset value makes the shadows darker while decreasing the offset makes the shadows more gray.</p> <p>Max — Multiplies the adjustments made in the Highlights section.</p>

Option	Description
Extra Parameters	<p>Blue Corr. — This is a correction for artifacts with “electric” blues. Bright blue will be desaturated rather than going violet.</p> <p>Gamut — Expands bright saturated colors outside the sRGB gamut to fake wide gamut rendering.</p> <p>Scene Tint — Sets the color tint for the scene.</p> <p>LUT Int. — Sets the intensity of the applied color look-up table (LUT). “0” is equal to no intensity and “1” applies full intensity.</p>

To reload color correction properties and cameras:

- Select the **Reload** button beside the **Camera** drop-down.

Video Walls

In the **Video Walls** panel, you can add Brompton controllers and trigger the listed color setting presets by double-clicking the preset or setting it up in an **Event** button. This could be useful when your IP controlled system is used to send different sources to the processor and each source requires different color settings.

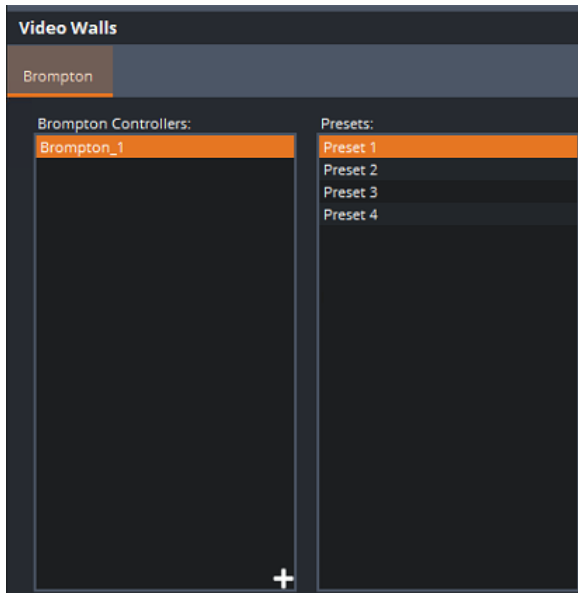

Video Walls Panel

To add a Brompton controller:

1. Select the **+** sign in the bottom-right corner of the Brompton Controllers pane.

The **New Brompton Controller** window opens.

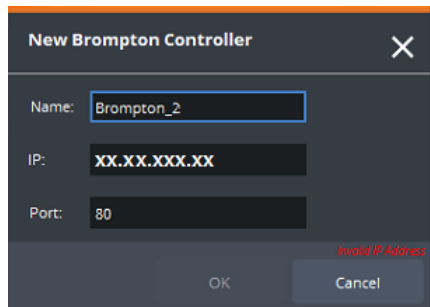

2. In the **Name** field, enter a name for the controller.
3. In the **IP** field, enter the IP address of the Lucid Studio machine.

The **Port** number is entered automatically. By default, the **Port** number is 80.

To edit a Brompton controller:

1. In the **Brompton Controllers** pane, right-click a controller and select **Edit**.

The **Edit Brompton Controller** window opens.

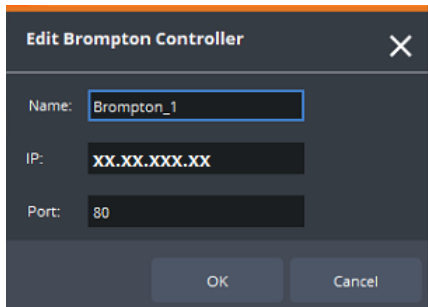

Edit Brompton Controller

2. Edit the **Name**, **IP** address or **Port** number of the controller.
3. Then select **OK**.

To delete a Brompton controller:

1. In the **Brompton Controllers** pane, right-click a controller and select **Delete**.
2. In the **Confirmation** dialog that opens, select **OK**.

Log

The log panel provides operational information in the form of log entries.

- Green text indicates normal activities.
- Orange text indicates a warning about something less serious than red text.
- Red text indicates unsuccessful connections or operations.

To manage the log:

1. Add the **Log** panel to the layout.

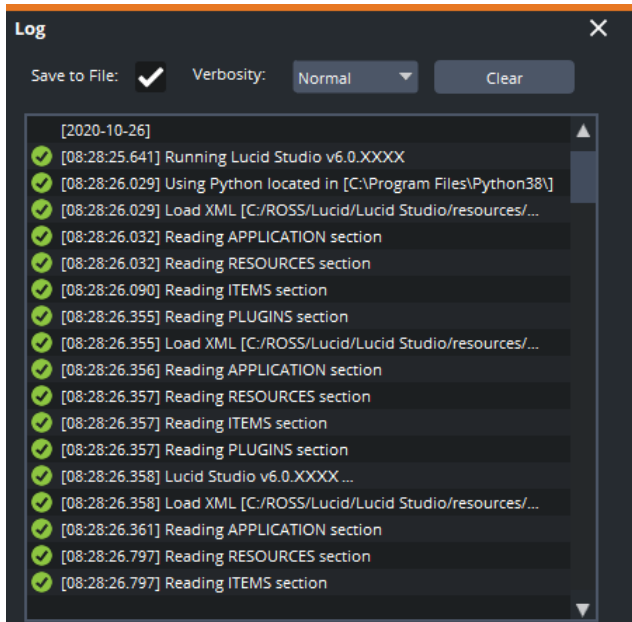

Log Panel

2. Select from the following options:

- **Save to File** — to date-stamp and save a copy of the current contents of the log in the Lucid Track folder (optional but useful when seeking assistance from Technical Support).

The default location is **C:\ROSS\Lucid\Lucid Track**.

The log file is called **LucidTrack_Log_date_time.log**.

- **Verbosity** — to select how much detail you want to see in the log.

3. At any time, you can select the **Clear** button to clear the contents of the log panel.

EndPoints

EndPoints can be used to change the IP address and port number to which to send commands, so that multiple actions that have been set up in the lab can quickly be rerouted to a new destination in the field. You can also store EndPoints as presets which can be called from the [Send](#), [Robotics](#) and [Miscellaneous](#) events in the **Events** panel.

To configure EndPoints:

1. In the **EndPoints** editor, in the **Setup** tab, select the **+** icon in the bottom-right corner of the **IP/Port** box.

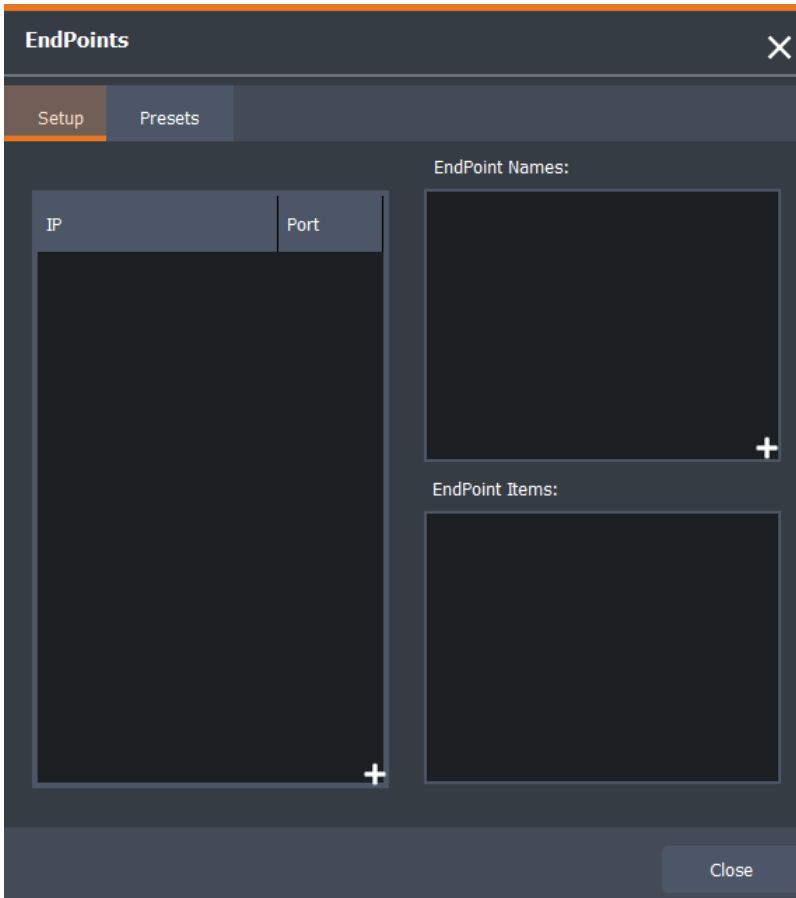

EndPoints Setup - New

2. In the **Add IP & Port** dialog, enter the IP address and port number of the machine(s) or camera(s) to which you want to send a command and select **OK**.
3. Repeat steps 1 and 2 for each machine or camera with which you want to communicate.
4. Then select the **+** icon in the **EndPoint Names** box.
5. In the **New EndPoint** dialog, enter a name for the **EndPoint** (e.g., Send) and select **OK**.

6. Select the IP addresses you want to assign to the new **EndPoint** and drag them to the **EndPoint Items** box.

Press the **Shift** or **Ctrl** key while selecting the IP addresses to select multiple addresses at once.

The selected IP addresses and ports are now assigned to the selected **EndPoint**.

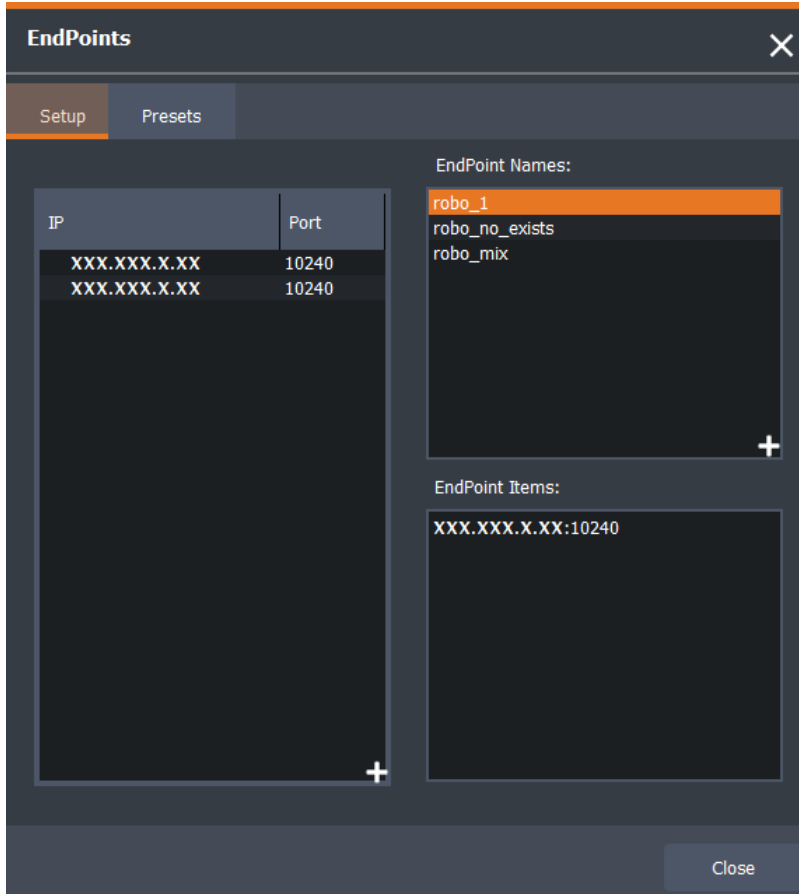

Endpoints Setup

7. Select **Close** to exit the **EndPoints** window.

To edit an IP address:

1. In the **EndPoints** editor, in the **Setup** tab, right-click an IP address and port and select **Edit**.
2. In the **Edit IP & Port** dialog, make the necessary changes and select **OK**.

To edit an EndPoint name:

1. In the **EndPoints** editor, in the **Setup** tab, right-click the **EndPoint** name and select **Edit**.
2. In the **Edit EndPoint** dialog, enter a new name and select **OK**.

To delete an IP address, EndPoint Name or EndPoint Item:

1. In the **EndPoints** editor, in the **Setup** tab, right-click the **IP** address, **EndPoint Name** or **EndPoint Item** and select **Delete**.
2. In the confirmation dialog (for **IP** addresses and **EndPoint** names only), select **OK**.

To configure an EndPoint Preset:

1. In the **EndPoints** editor, create an **EndPoint** and assign IP addresses to it.
2. In the **Presets** tab, select the **+** icon in the bottom-right corner of the **Presets** box.
3. In the **New Preset** dialog, enter a name for the **Preset** (e.g., Trade Show) and select **OK**.

The **EndPoint** is now stored as a **Preset** and is available in the [Send](#), [Robotics](#) and [Miscellaneous](#) events in the **Events** panel.

To edit a Preset:

1. In the **EndPoints** editor, in the **Presets** tab, right-click a **Preset** and select **Edit**.
2. In the **Edit Preset** dialog, enter a new name or select the **Overwrite preset** checkbox to overwrite the preset with all the **EndPoints** contained in the **Setup** tab.
3. Then select **OK**.

To delete a Preset:

1. In the **EndPoints** editor, in the **Presets** tab, right-click a preset and select **Delete**.
2. In the confirmation dialog, select **OK**.

User Input Control

You can use the **User Input Control** feature to add a **Static List**, **Global List** or **DataLinq** source to populate text items in a scene.

A static list applies to the text item in which it is created, while a global list is available to all text items.

Global lists and DataLinq sources can be edited anywhere that the **User Input Control** feature appears in the UI (in the [Sequencer](#), in [Events](#) in a [Position](#) event action, in [Lucid Studio Setup in the Lucid tab](#), etc.)

To use the **User Input Control**, you need to create a list manually or import an existing text file, a **Lucid User Input Control** file with the extension **.uxuic** (a list that has been created and saved in Lucid Studio), or use data from a DataLinq source.

[Selecting a List Type](#)

[Creating or Importing a Static List](#)

[Creating or Importing a Global List](#)

[Creating a List Using a DataLinq Source](#)

[Exporting a Static or Global List](#)

[Editing a List](#)

Selecting a List Type

You need to decide what type of list you want to use in your user input control. There are several options:

- **Static List** - applies solely to the item in which it is created.
- **Global List** - can be used in any item.
- **DataLinq** - the list can be updated in real-time as the DataLinq source is updated.

To select a list type:

1. In the **Position** panel, in the **Text Item** for which you want to create a list, select the text (T) icon.
2. From the **Text** drop-down, select **User Input Control**.

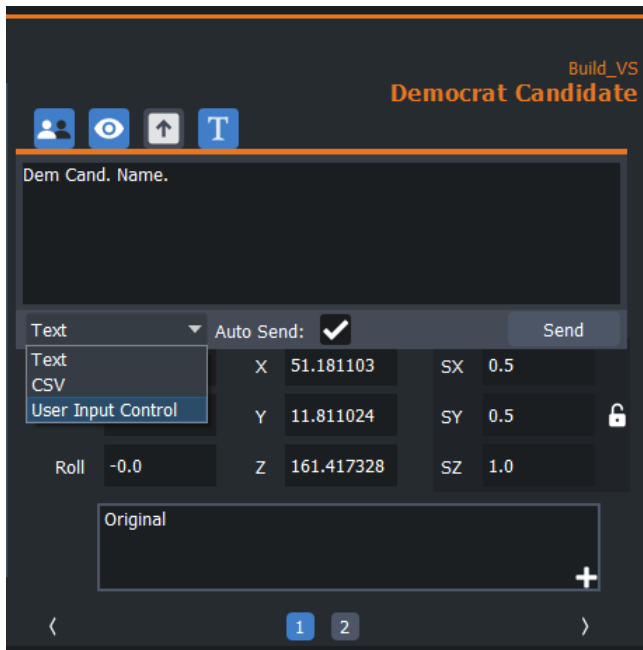

Select User Input Control

3. In the **User Input Control** pane, select **Options**.
The **User Input Control** window opens.

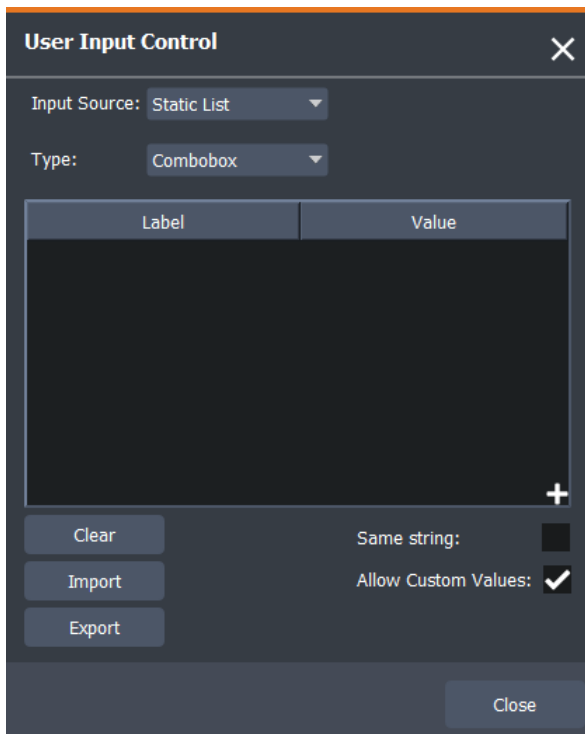

User Input Control Window

4. From the **Input Source** drop-down, select one of the following options:
 - [Static List](#)
 - [Global List](#)
 - [DataLinq](#)
5. From the **Type** drop-down, select whether to display the text as a **List** or as a **Combobox**.
 - If **List** is selected, the entire list is displayed in the **User Input Control** pane.
 - If **Combobox** is selected, a drop-down is created, from which you can select the text you want.
6. Continue with the instructions for the selected option.

Creating or Importing a Static List

After selecting **Static List** as the **Input Source** (refer to [Selecting a List Type](#)), you can create a static list manually or [import an existing static list](#).

To create a static list manually:

1. In the bottom-right corner of the **Label/Value** pane, select the **+** icon.

The **New-User Input Control** dialog opens.

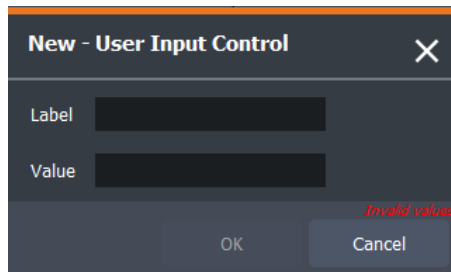

The dialog box titled "New - User Input Control" has a close button (X) in the top right corner. It contains two input fields: "Label" and "Value". Both fields are currently empty. At the bottom, there are "OK" and "Cancel" buttons. A red error message "Invalid values" is visible near the "Cancel" button.

New User Input Control

2. In the **Label** field, enter a name for the text.
3. In the **Value** field, enter the text that will be displayed when that label is selected.

If you want your list to have headings, enter the column headings in the **Label** and **Value** fields.

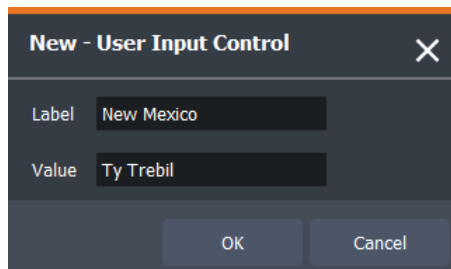

The dialog box titled "New - User Input Control" has a close button (X) in the top right corner. The "Label" field now contains the text "New Mexico" and the "Value" field contains "Ty Trebil". At the bottom, there are "OK" and "Cancel" buttons.

Add New User Input Control

4. Then select **OK**.

The **Label | Value** pane displays the new text item.

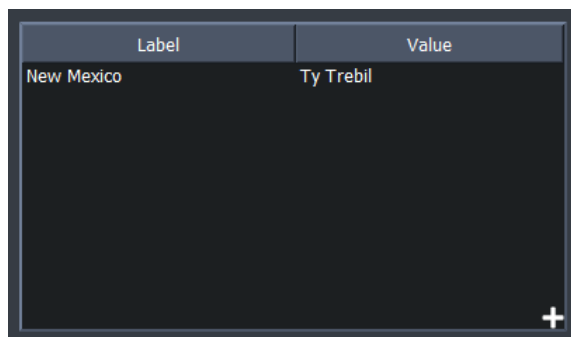

Label	Value
New Mexico	Ty Trebil

The table is displayed in a dark-themed pane. A plus sign (+) is visible in the bottom right corner of the pane.

User Input Control With Manually-Added Text

- Repeat Steps 1 to 4 to add more text items to the list.

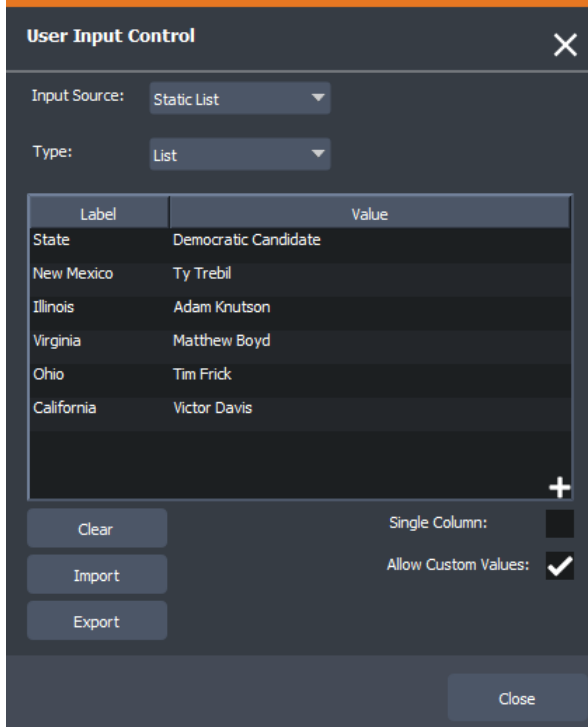

User Input Control - Manually Created List

- Select the **Single Column** checkbox to reduce the list to just one set of values. The **Label** field and the **Value** field will be the same.
- Select the **Allow Custom Values** checkbox to allow the user to enter any text in the **Value** field of the **User Input Control** pane.
- Select **Close** to exit the **User Input Control** window.

To import a static list:

1. In the **User Input Control** window, select **Import**.

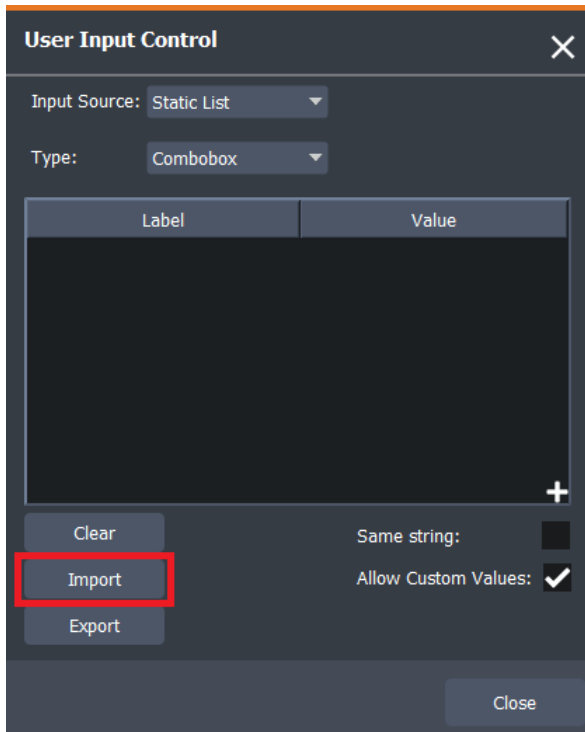

User Input Control - Import

2. In the **Select File** window, navigate to the location where you have saved your text files.
3. Select the file you want to import.

★ Supported text files are those ending with the extension **.uxuic** or **.txt**. You can also use a **.csv** file (with comma separated values) that has been saved with the **.txt** extension.

4. Select **Open**.

If you are importing a **.txt** file, the **Importing User Input Control List** dialog opens.

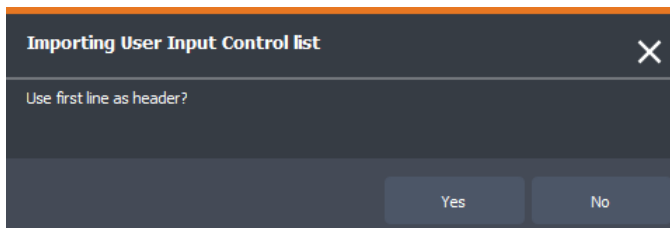

User Input Control - Import List

5. In the **Importing User Input Control List** dialog, select **Yes** or **No**, depending on the following:

If the list you are importing has a header row, select **Yes** to use the header in the list.

The **Label** and **Value** headings will be replaced by the header text in the first 2 columns of the imported list.

OR

If the list you are importing does not have a header row, select **No**.

The list will be displayed with the default **Label** and **Value** headings.



State	Democratic Candidate
New Mexico	Ty Trebil
Illinois	Adam Knutson
Virginia	Matthew Boyd
Ohio	Tim Frick
California	Victor Davis

User Input Control - Imported List

6. Select **Close** to exit the **User Input Control** window.

Creating or Importing a Global List

After selecting **Global List** as the **Input Source** (refer to [Selecting a List Type](#)), you can create a global list manually, or [import an existing global list](#).

To create a global list manually:

1. In the **User Input Control** window, select the **Edit Global Lists** button.

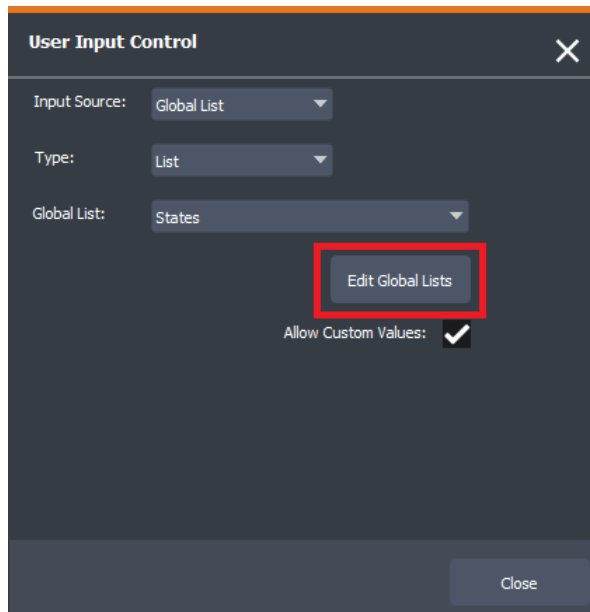

User Input Control - Edit Global Lists

The **User Input Control - Global Lists** window opens. Any existing global lists appear in the **Global List** pane.

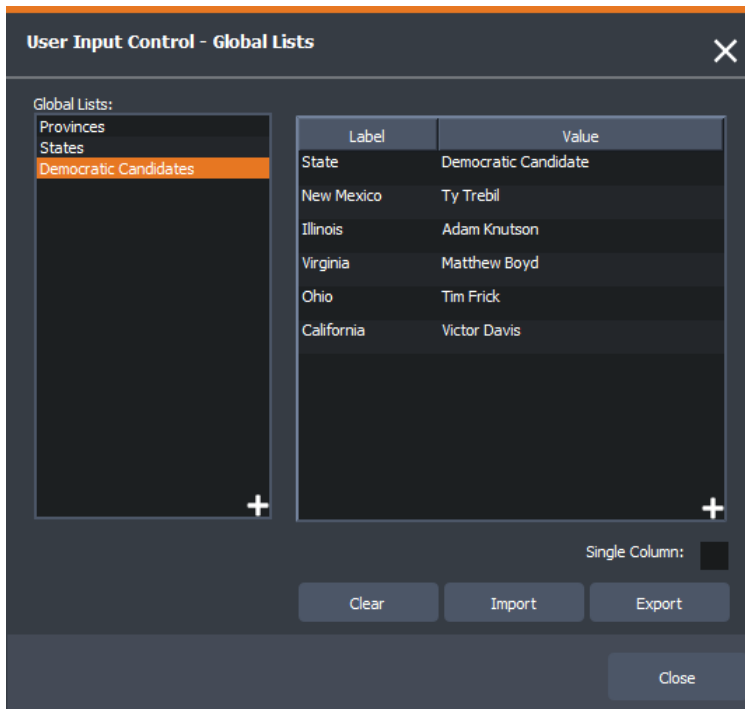

User Input Control - Global Lists

2. In the bottom-right corner of the **Global Lists** pane, select the **+** icon.

The **New Global List** dialog opens.

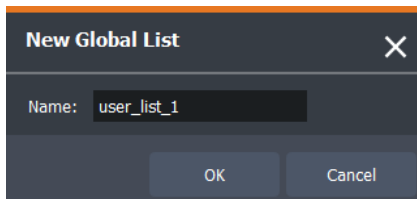

User Input Control - New Global List

3. In the **Name** field, enter a name for the new global list and select **OK**.

The new global list is added to the **Global Lists** pane and the **Label/Value** pane is cleared.

4. In the bottom-right corner of the **Label/Value** pane, select the **+** icon.

The **New-User Input Control** dialog opens.

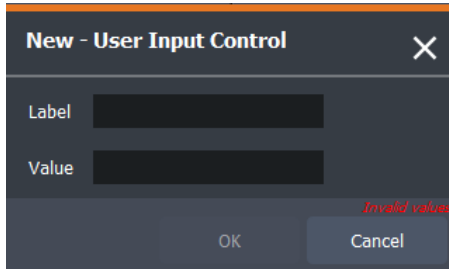

The dialog box titled "New - User Input Control" has a close button (X) in the top right corner. It contains two input fields: "Label" and "Value". Below the "Value" field, there is a red error message that reads "Invalid value". At the bottom of the dialog, there are two buttons: "OK" and "Cancel".

New User Input Control

5. In the **Label** field, enter a name for the text.
6. In the **Value** field, enter the text that will be displayed when that label is selected.
7. If you want your list to have headings, enter the heading text in the **Label** and **Value** fields as well and then select **OK**.

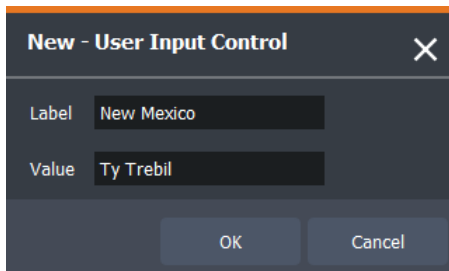

The dialog box titled "New - User Input Control" has a close button (X) in the top right corner. The "Label" field contains the text "New Mexico" and the "Value" field contains the text "Ty Trebil". At the bottom of the dialog, there are two buttons: "OK" and "Cancel".

Add New User Input Control

The **Label | Value** pane displays the new text item.

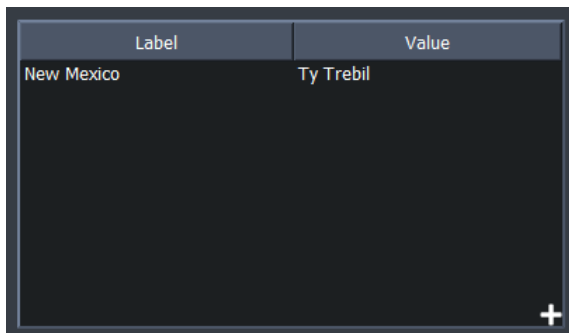

The "User Input Control" pane is shown as a table with two columns: "Label" and "Value". The first row contains the text "New Mexico" under the "Label" column and "Ty Trebil" under the "Value" column. A plus sign (+) icon is located in the bottom right corner of the pane.

Label	Value
New Mexico	Ty Trebil

User Input Control With Manually-Added Text

8. Repeat Steps 1 to 4 to add more text items to the list.

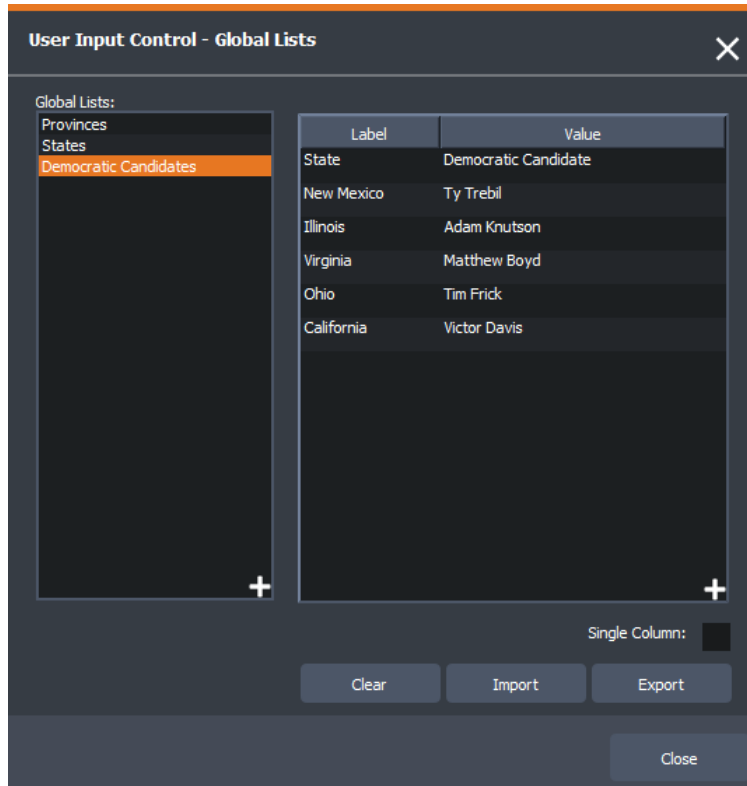

User Input Control - Manually Created Global List

9. Select the **Single Column** checkbox to reduce the list to just one set of values.

The **Label** field and the **Value** field will be the same.

10. Select **Close** to exit the **Edit Global Lists** window.

11. In the **User Input Control** window, select the **Allow Custom Values** checkbox to allow the user to enter any text in the **Value** field of the **User Input Control** pane.

12. Select **Close** to exit the **User Input Control** window.

To import a Global list:

1. In the **User Input Control** window, select the **Edit Global Lists** button.

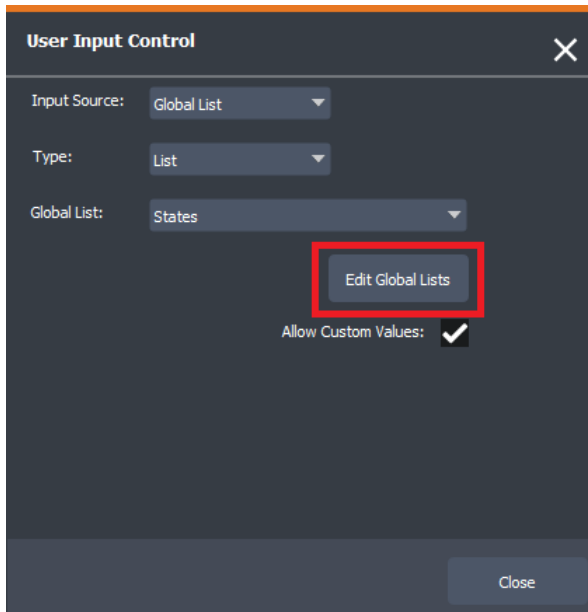

User Input Control - Edit Global Lists

The **User Input Control - Global Lists** window opens. Any existing global lists appear in the **Global List** pane.

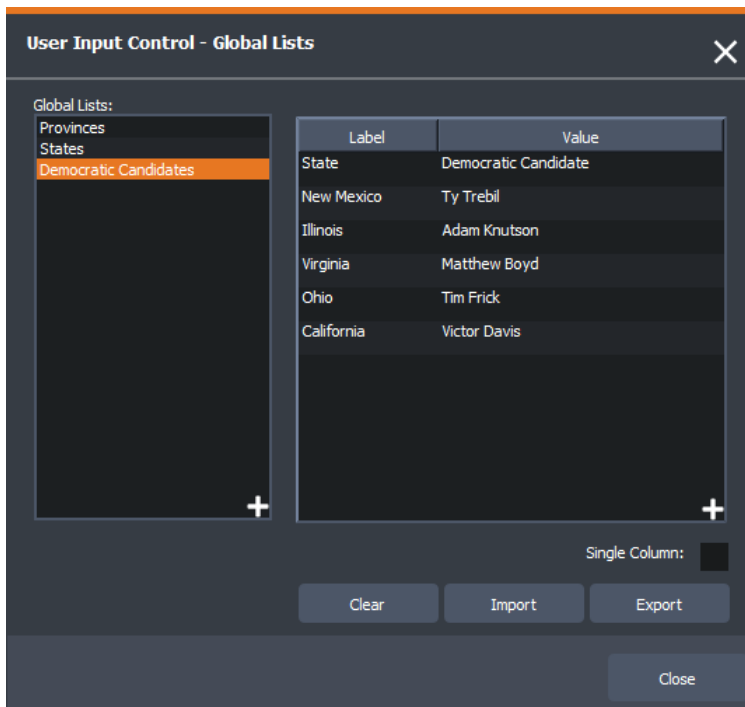

User Input Control - Global Lists

- In the bottom-right corner of the **Global Lists** pane, select the **+** icon.

The **New Global List** dialog opens.

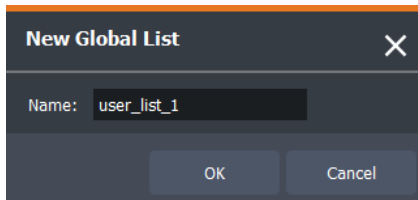

User Input Control - New Global List

- In the **Name** field, enter a name for the new global list and select **OK**.

The new global list is added to the **Global Lists** pane and the **Label/Value** pane is cleared.

- With the new global list highlighted, select **Import**.

- In the **Select File** window, navigate to and select the global list file you want to import and select **Open**.

★ Supported text files are those ending with the extension **.luxuic** or **.txt**. You can also use a **.csv** file (with comma separated values) that has been saved with the **.txt** extension.

If you are importing a **.txt** file, the **Importing User Input Control Global List** dialog opens.

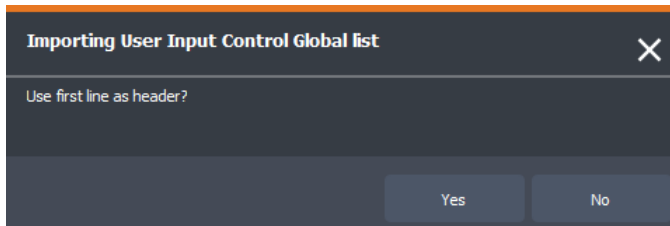

User Input Control - Import Global List

- In the **Importing User Input Control Global List** dialog, select **Yes** or **No** depending on the following:

If the list you are importing has a header row, select **Yes** to use the header in the list.

The **Label** and **Value** headings will be replaced by the header text in the first 2 columns of the imported list.

OR

If the list you are importing does not have a header row, select **No**.

The list will be displayed with the default **Label** and **Value** headings.



State	Democratic Candidate
New Mexico	Ty Trebil
Illinois	Adam Knutson
Virginia	Matthew Boyd
Ohio	Tim Frick
California	Victor Davis

User Input Control - Imported List

- Select **Close** to exit the **Global Lists** window.
- Select **Close** to exit the **User Input Control** window.

To delete a Global List:

1. In the **User Input Control - Global Lists** window, in the **Global Lists** pane, right-click the list you want to delete and select **Delete**.
2. In the **Confirmation** dialog, select **OK**.

Creating a List Using a DataLinq Source

You will need to have the XPression DataLinq Server installed and running in order to use a DataLinq source to create a list. Only use data sources that are formatted as tables.

After selecting **DataLinq** as the **Input Source** (refer to [Selecting a List Type](#)), you can proceed to configure a DataLinq source to generate a list.

To select a DataLinq source:

1. From the **DataLinq** drop-down, select the DataLinq Server you will be using.

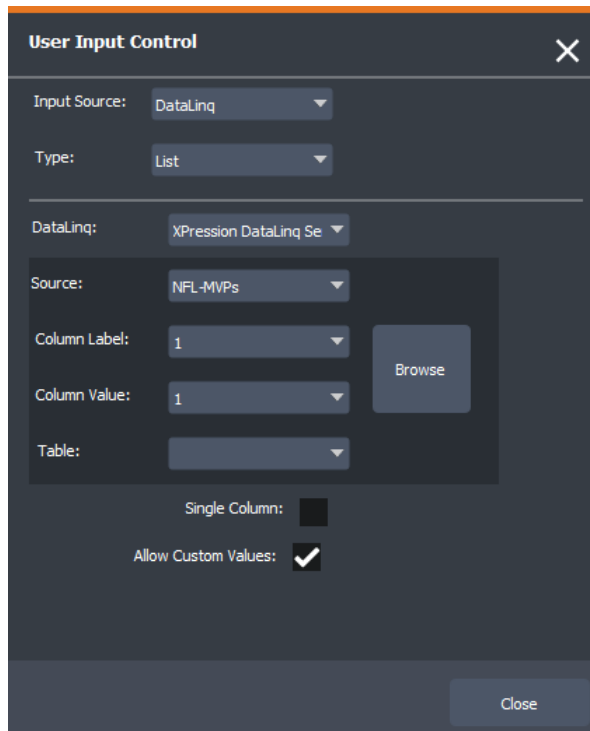

User Input Control - DataLinq

2. From the **Source** drop-down, select the DataLinq source.
For information on configuring a DataLinq source, see [DataLinq](#).
3. Use one of the following methods to select the data to use in a list:
[Select data from the drop-downs.](#)
[Select data from the table view.](#)
4. Select the **Single Column** checkbox to reduce the list to just one set of values.
5. Select the **Allow Custom Values** checkbox to allow the user to enter any text in the **Value** field of the **User Input Control** pane.
6. Select **Close** to exit the **User Input Control** window.

To select data from the drop-downs:

1. From the **Column Label** drop-down, select the label you want to display in your list.
2. From the **Column Value** drop-down, select the value you want to display in your list.
3. If your DataLinq source has more than one table, from the **Table** drop-down, select the table you want to use.

To select data from the table view:

1. Select the **Browse** button to open the table view.

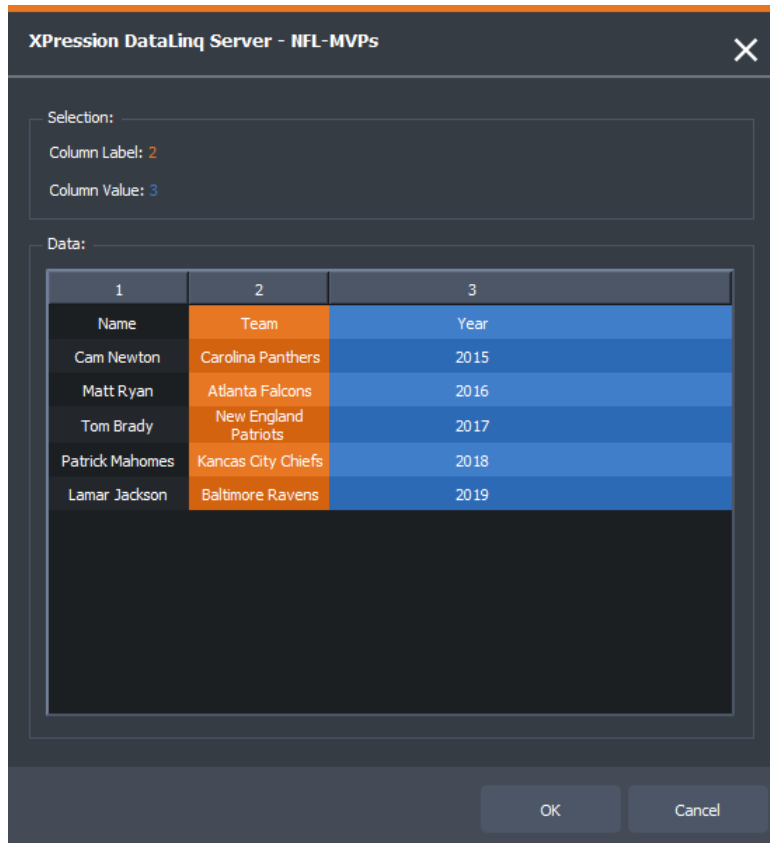

User Input Control - DataLinq - Table View

2. Select the column containing the labels you want to use and then select the column containing the values you want to use.

The **Column Labels** property will be updated in orange and the **Column Values** property will be updated in blue.

3. If your DataLinq source has more than one table, a **Table** drop-down appears in the table view, from which you can select the table you want to use.
4. Select **OK** to close the table view.
5. Select **Close** to exit the **User Input Control** window.

Exporting a Static or Global List

You can save a static or global list that you have created to be used again.

[Export a static list](#)

[Export a global list](#)

To export a static list:

1. After creating or editing a new static list, in the **User Input Control** window, select **Export**.

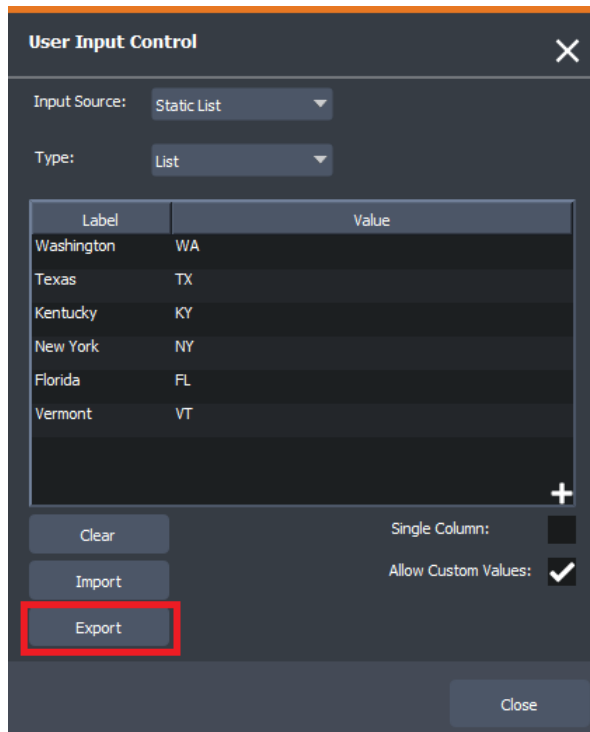

User Input Control - Export Static List

2. In the **New File** window, navigate to the folder where you want to save your list and in the **File name** field, enter a name for the list.
3. From the **Save as type** drop-down, select whether to save the list as a **.txt** file or a **.uxuic** file.
4. Then select **Save**.
5. Select **Close** to exit the **User Input Control** window.

To export a global list:

1. After creating or editing a new global list, in the **User Input Control - Global Lists** window, select **Export**.

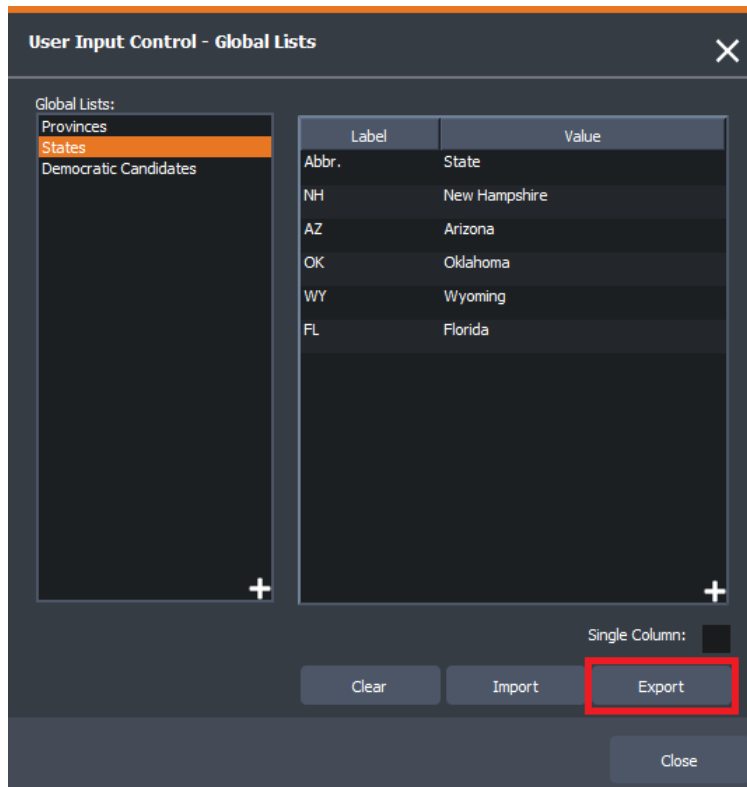

User Input Control - Export Global List

2. In the **New File** window, navigate to the folder where you want to save your list and in the **File name** field, enter a name for the list.
3. From the **Save as type** drop-down, select whether to save the list as a **.txt** file or a **.uxuic** file.
4. Then select **Save**.
5. Select **Close** to exit the **User Input Control - Global Lists** window.
6. Select **Close** again to exit the **User Input Control** window.

Editing a List

You can edit the content of a static or global list or change the column label, column value or table of a DataLinq source. You can also [change the order](#) of a list.

[Static List](#)

[Global List](#)

[DataLinq Source](#)

To edit the content of a static list:

1. In the **User Input Control** window, from the **Input Source** drop-down, select **Static List**.
2. Then select **Import** to open an existing list.
3. In the **Select File** window, navigate to and select the list you want to import and select **Open**.

The list opens in the **Label/Value** pane.

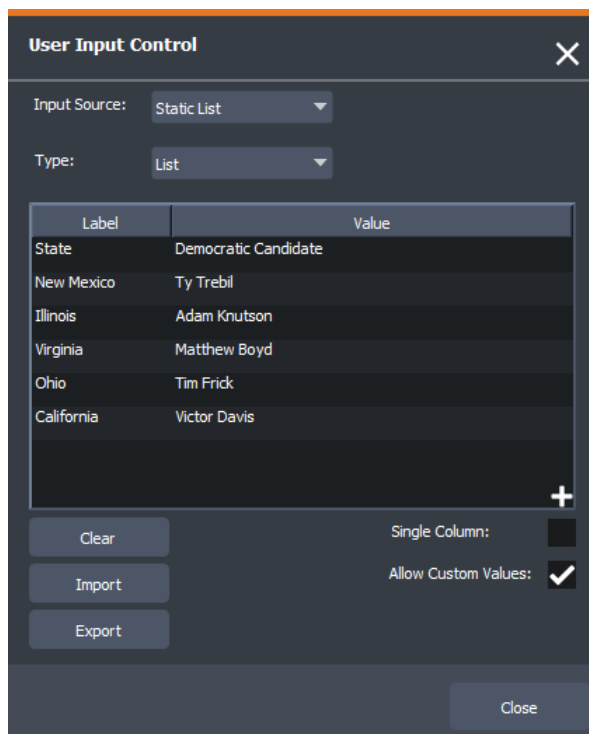

User Input Control - Import Static List

4. Right-click in the row containing the text you want to edit and select **Edit**.

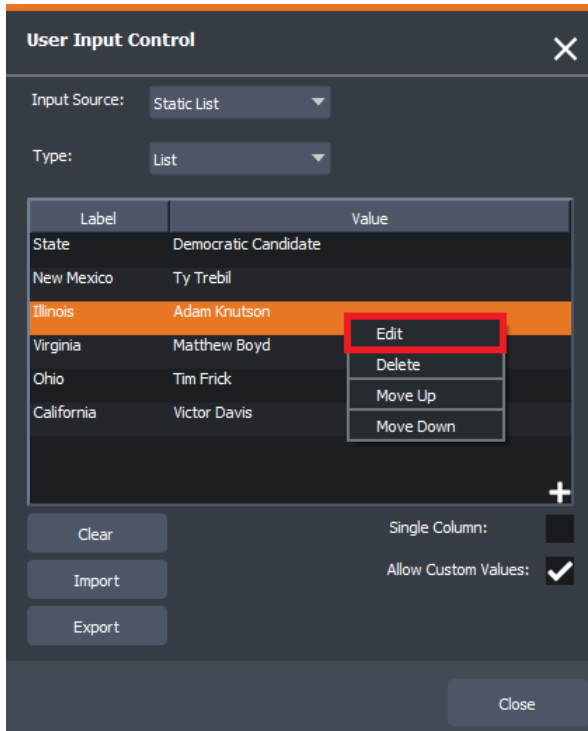

User Input Control - Edit

The **Edit - User Input Control** dialog opens.

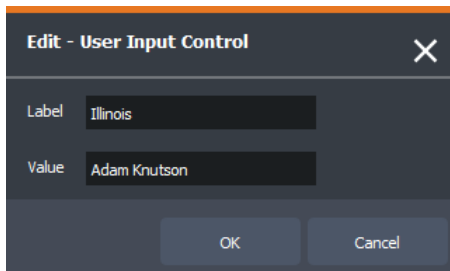

User Input Control - Edit User Input Control

5. Edit the **Label** or **Value** and select **OK**.

The edited text appears in the list in the **User Input Control** window.

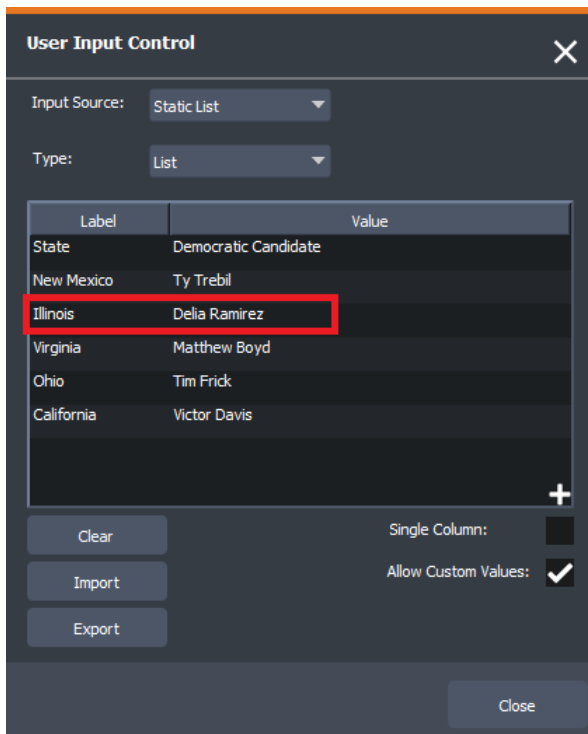

User Input Control - Edited Static List

To edit a Global list:

1. In the **User Input Control** window, from the **Input Source** drop-down, select **Global List**.
2. Select **Edit Global Lists**.

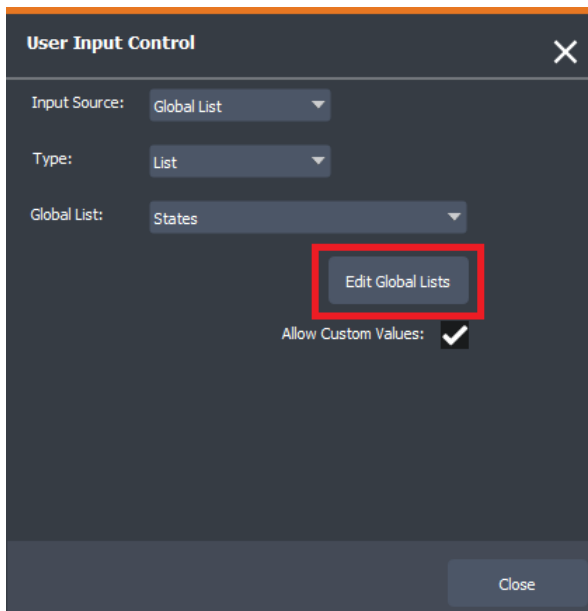

User Input Control - Static List

3. From the **Global Lists** pane, select the list you want to edit.
The content of the selected list is displayed in the **Label/Value** pane.

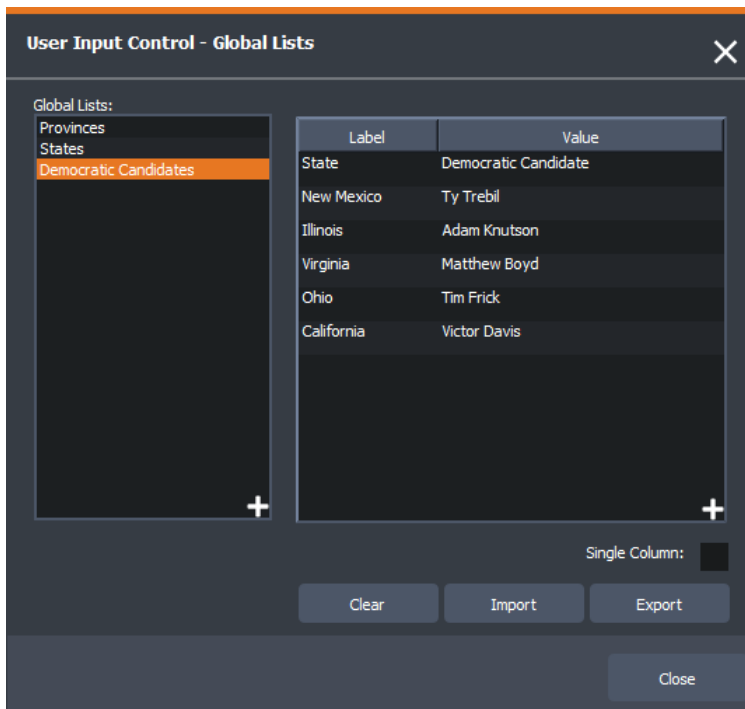

User Input Control - Select Global List

4. Right-click an item in the **Label/Value** pane and select **Edit**.

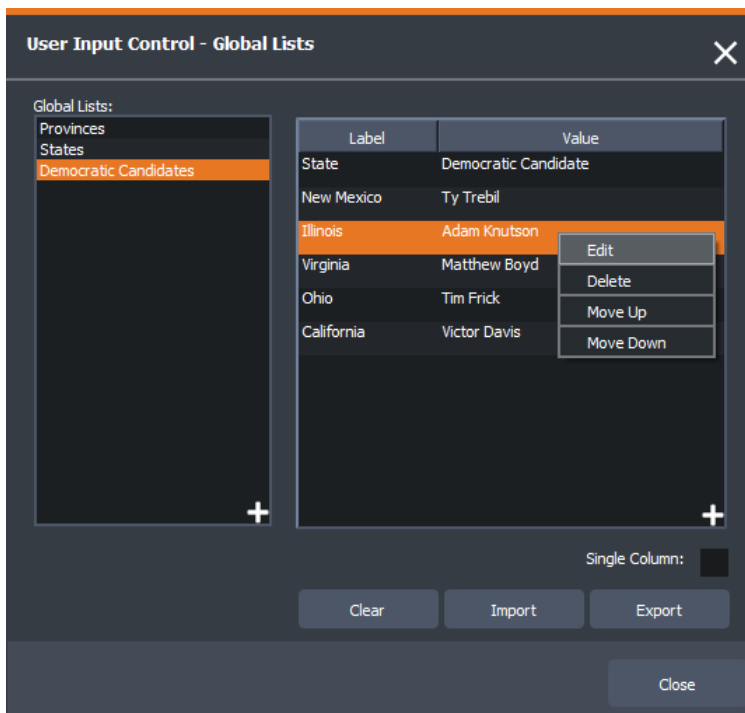

User Input Control - Select Edit

The **Edit - User Input Control** dialog opens.

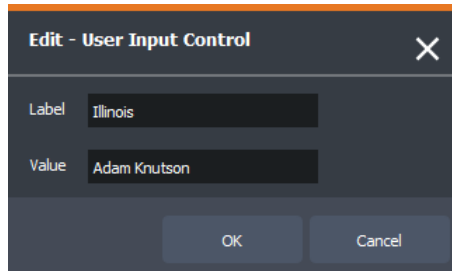

User Input Control - Edit User Input Control

5. Edit the **Label** or **Value** and select **OK**.

The edited text appears in the list in the **User Input Control** window.

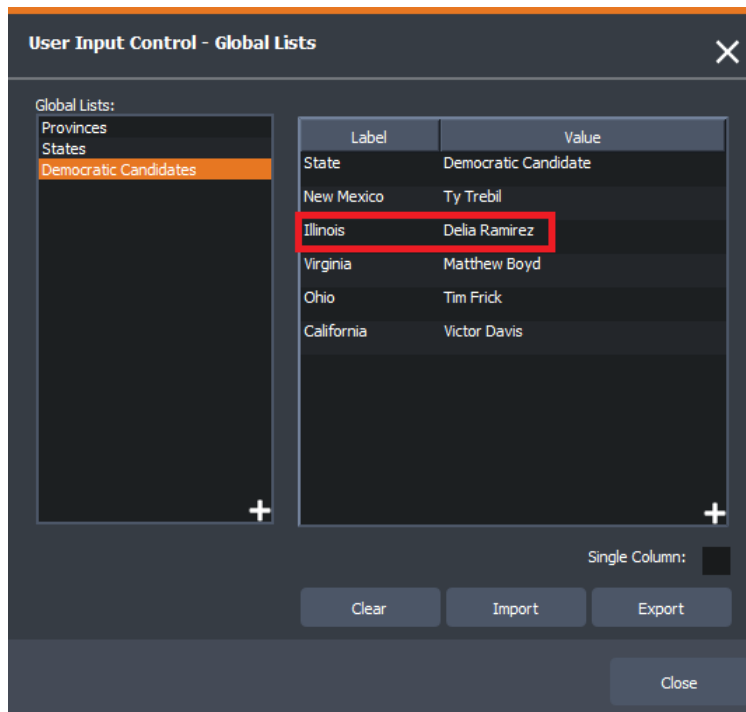

User Input Control - Edited Global List

To edit a DataLinq source:

1. In the **User Input Control** window, from the **Input Source** drop-down, select **DataLinq**.
2. In the **DataLinq** section, from the **DataLinq** drop-down, select the DataLinq server you are using.
3. From the **Source** drop-down, select the DataLinq source you want to edit.
4. From the **Column Label**, **Column Value**, or **Table** drop-downs, select a different option.

Alternatively, you can select **Browse** to open the **Table** view and change your selections there.

To change the order of a list:

- Right-click on an item in the list and select **Move Up** or **Move Down** to change the order of the list.

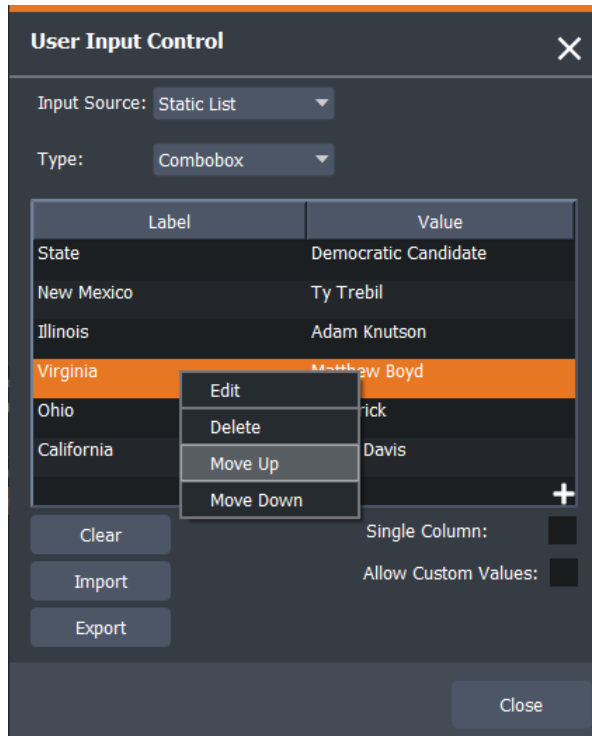

User Input Control - Move Up or Move Down

Lucid Driver for XPression

Lucid Driver for XPression is the component that communicates with the Lucid Studio user interface and directly controls the rendering of the virtual environment designed in XPression. Lucid Driver is also responsible for responding to the full range of operational control commands that can be executed by the Lucid Studio operator. Each time the user moves a virtual object in the Position panel or assigns a new source to a target in the Router panel, for example, a command is sent from Lucid Studio to the driver(s), which, in turn, adjusts the virtual scene accordingly.

In a networked Lucid Studio system, there is typically a single instance of Lucid Studio controlling one or more camera/renderer systems. For each camera, there is a dedicated XPression rendering system. The rendering system and Lucid Driver are installed on the same machine.

The rendering systems are responsible for the real-time rendering of the virtual scene from the perspective of their associated physical cameras. All cameras in a system simultaneously receive the same control commands. In this way, if a virtual object is moved, the move is seen by all of the cameras, each of which may be viewing it from a different angle.

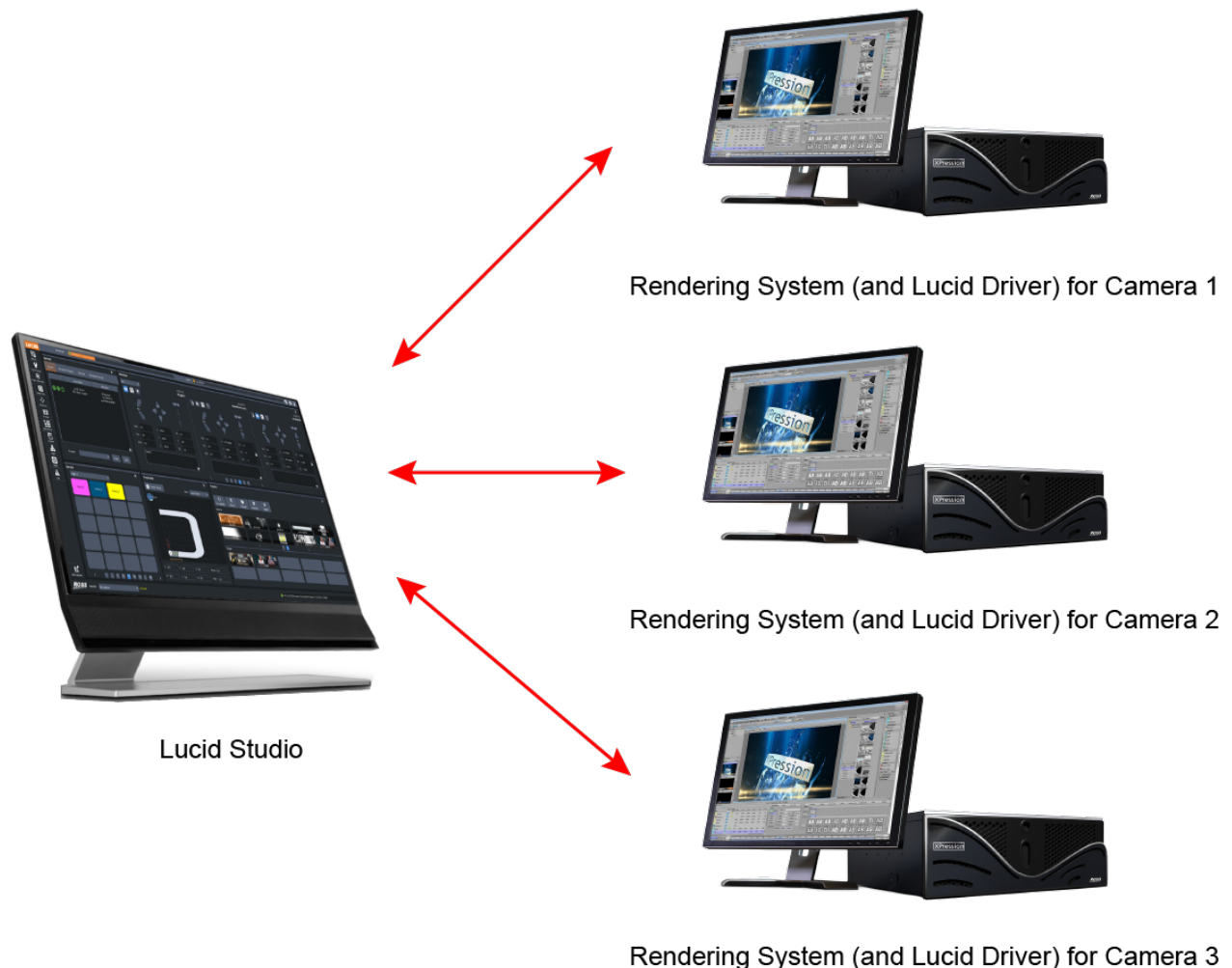

Typical Lucid Networked Configuration

Exploring the Lucid Driver for XPression Interface

When Lucid Driver for XPression is launched the Lucid Driver and XPression icons appear in the Windows tool tray and the application opens with the last previously opened project loaded. If XPression is configured to use a virtual output, then the output window will also appear.

The Lucid Driver for XPression application then opens on your screen, containing the following four drop-downs:

[Settings](#)

[XPression](#)

[Log](#)

[About](#)

Settings

The **Settings** panel provides the fields and controls described below:

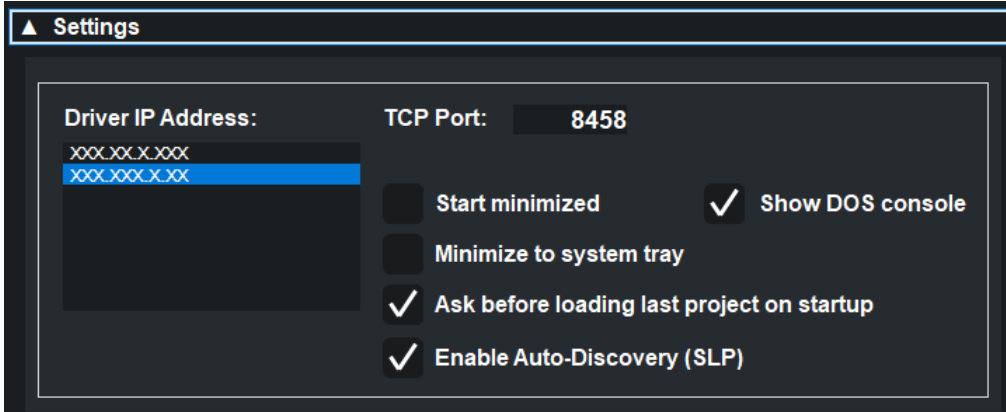

Lucid Studio Driver Settings Panel

- **Driver IP Address**

This is the IP address of the Driver. Available IP addresses are listed. Select the address you want to use.

- **TCP Port**

This is the operation port that allows Lucid Studio to send commands to the renderer. A default port is automatically shown but can be changed if necessary. The same port number is entered in Lucid Studio in the **Oper. Port** field, when you configure the renderer.

- **Start minimized**

When checked, Lucid Driver will be minimized to the task bar on startup.

- **Minimize to system tray**

When checked, Lucid Driver will be stored in the system tray. Selecting the Lucid Driver icon in the system tray will open a smaller utility version of the UI. To open the full version, select the **Settings** button in the bottom-left corner of the UI.

- **Ask before loading last project on startup**

When selected, a dialog opens at startup to confirm that you want to load the last project that was opened. Default is cleared.

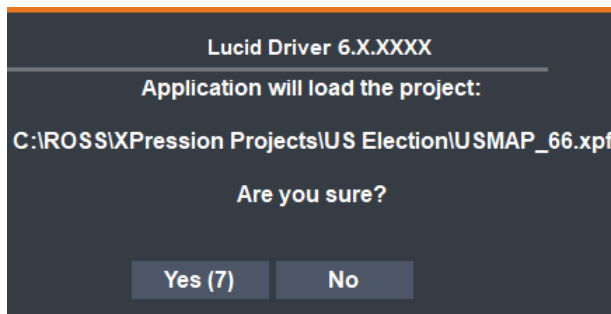

Figure 4.3 Lucid Driver Project Loading Dialog

- **Enable Auto-Discovery (SLP)**

When selected, Lucid Studio will be able to detect any XPression renderers on the network.

Default is selected.

- **Show DOS console**

When selected, the **Lucid Driver DOS** console will be opened and minimized to the task bar, so you can see the internal operations of the Driver. This is useful for troubleshooting. Default is selected.

XPression

The **XPression** panel provides the fields and controls described below:

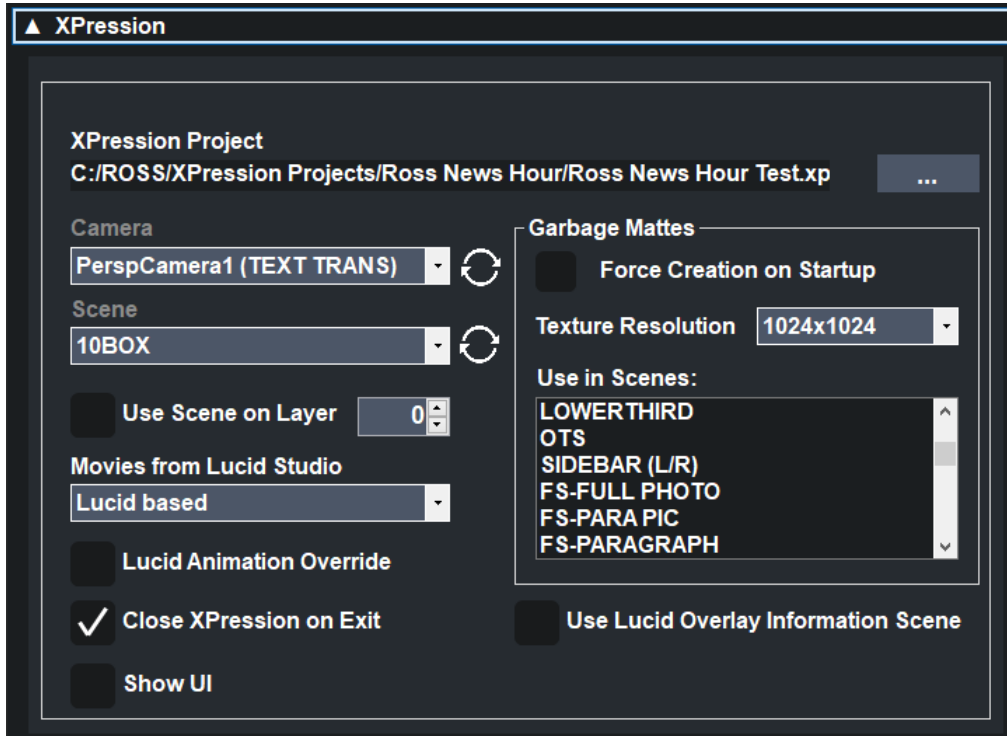

Lucid Driver XPression Panel

- **XPression Project**

This is the name and path to the XPression project that will be used for the virtual set and/or augmented-reality graphics. Use the **Browse** button to navigate to your project.

This is automatically set when you use RVS Engine Service to remotely start and stop projects from Lucid Studio.

- **Camera**

This is the name of the virtual camera within the XPression project that will be associated with the attached tracked physical camera. As the physical camera moves, the values for position, rotation, zoom, and focus are applied to the named virtual camera within XPression. The drop-down lists the available cameras.

- **Scene**

This is the name of the default scene to be used within the selected XPression project for the virtual set and/or augmented-reality graphics. The drop-down lists the available scenes.

- **Use Scene on layer**

When a scene has multiple layers, this checkbox and scroll box allow users to specify which layer of the output Lucid Studio will control.

- **Movies from Lucid Studio**

For movies that are used on materials in Lucid Studio, this drop-down provides a means to select whether the movie will be affected by light in an XPression scene.

The options are:

- **Lucid based** - Targets with the same movie applied use duplicate instances of the same movie file and can be individually lit or unlit as specified in the Router settings in Lucid Studio.
- **All lit** - Targets with the same movie applied use the same movie file and will be affected by light in the XPression scene.
- **All unlit** - Targets with the same movie applied use the same movie file and will not be affected by light in the XPression scene.

- **Lucid Animation Override**

When unchecked, any animation activated in the **Position** panel will play out in its entirety.

When checked, you can override an active animation with an event that controls the same item. This allows for a quick recovery if an animation has been incorrectly created or the operator triggers it at the wrong time or changes his mind.

- **Close XPression on Exit**

This checkbox will enable an auto close that shuts down the XPression renderer when Lucid Driver is closed. Default is checked.

- **Show UI**

When checked the XPression user interface will be displayed when you select the XPression Studio icon in the task bar. This option also appears on the smaller version of the UI that resides in the system tray, if you've elected to minimize Lucid Driver to the system tray.

- **Garbage Mattes**

- **Force Creation on Startup**

When checked, generates a default set of garbage mattes on the selected scene in the renderer project. If the garbage mattes are quite large or have a high feather value, it can take several minutes for them to be generated.

Any existing garbage mattes will be overwritten.

- **Texture Resolution**

When checked, generates a default set of garbage mattes on the selected scene in the renderer project. If the garbage mattes are quite large or have a high feather value, it can take several minutes for them to be generated.

- **Use in Scenes**

When selected, the available scenes to which the garbage mattes can be applied are listed.

Only selected scenes will have garbage mattes applied.

- **Use Lucid Overlay Information Scene**

When checked, enables the display of statistics when a **Send Command to Renderer** action is set up in a **Misc** event requesting **Performance Stats**. Currently, frames per second is the only performance statistic available in XPression. It creates a scene used as a layer displaying the frames per second in the top left corner of the **Virtual Output** window. You can also enable a **Clear Stats** event to remove the display.

See [Events > Misc](#) for more information.

Log

The **Log** panel displays a record of activities in Lucid Driver.

Green text indicates normal activities.

Red text indicates unsuccessful connections or operations.

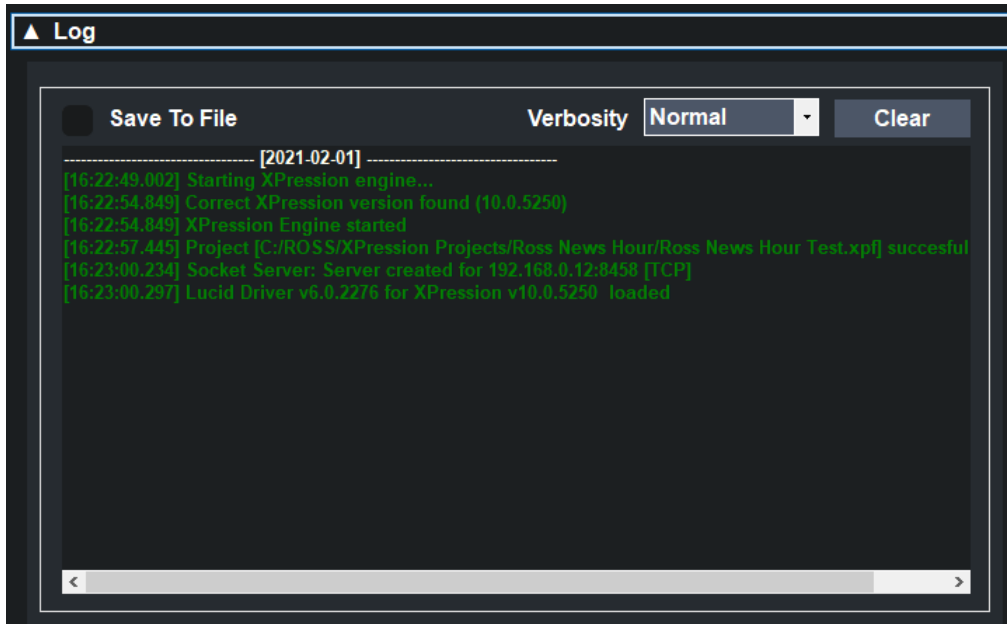

Lucid Driver Log Panel

The **Log** settings are described below:

- **Save To File**

When checked, a copy of the current contents of the log is saved to the Lucid Driver folder.

The default location is **C:\ROSS\Lucid\Driver XPression**.

- **Verbosity**

From the drop-down, you can select how much detail you want to see in the log.

- **Clear**

Clears the current log entries.

About

The **About** panel provides the version number of Lucid Driver and the copyright information.

RVS Engine Service

RVS Engine Service is a component that allows Lucid Studio to remotely load and run multiple projects. It needs to be on the same computer as the renderer.

With the XPression renderer, RVS Engine Service restarts Lucid Driver for XPression with the selected project, which in turn restarts the renderer with the selected project. RVS Engine Service and Lucid Driver for XPression need to be running on the same machine.

With the Voyager renderer, RVS Engine Service launches the selected project directly.

Exploring the RVS Engine Service Interface

The RVS Engine Service window has three drop-downs:

[Settings](#)

[Log](#)

[About](#)

Settings

The contents of the **Settings** panel change depending on the selected renderer. The fields and controls in the image below are for a Voyager renderer.

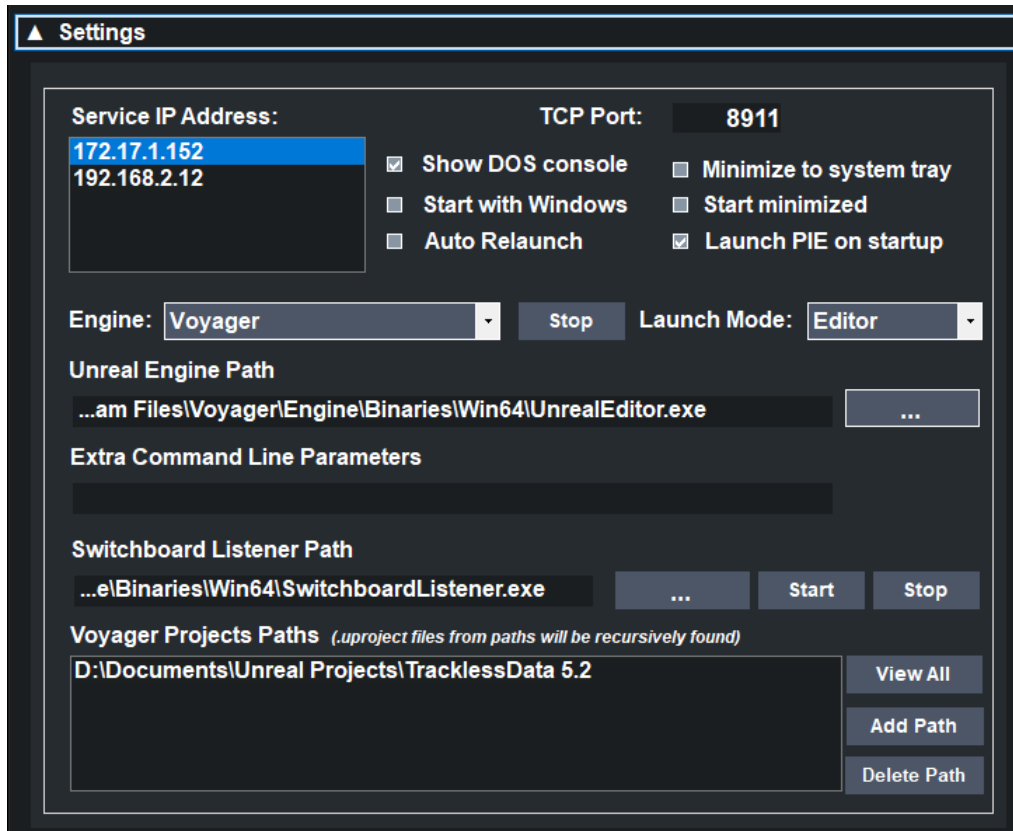

RVS Engine Service - Settings for Voyager

- **Service IP Address**

The IP address of the machine running RVS Engine Service. Select from an automatically generated list of available IP addresses.

- **TCP Port**

The port to be used by RVS Engine Service. A default port is automatically entered here, but can be changed if it is already in use.

- **Show DOS console**

When selected, keeps an instance of the console running continuously.

- **Start with Windows**

When selected, RVS Engine Service will start automatically when Windows starts.

- **Auto Relaunch**

When selected, the renderer will be automatically relaunched should there be an issue that causes it to stop.

- **Minimize to system tray**

When selected, the application is stored in the system tray. Selecting the **RVS Engine Service** icon in the system tray will open a smaller utility version of the UI. To open the full version, select the **Settings** button in the bottom-left corner of the UI.

- **Start minimized**

When selected, RVS Engine Service will start minimized to the system tray.

- **Launch PIE on startup** (Voyager renderer only)

When selected, Voyager will open in **Edit** mode. This setting will be over-ridden if **Game** is selected from the **Launch Mode** drop-down.

- **Engine**

This drop-down contains a list of connected engines. Lucid Studio remembers the settings for each engine when you switch from one to another.

The options are:

- **XPression**

- **Voyager**

- **Switchboard Listener Only**

- **Launch Mode** (if you've chosen a Voyager engine)

From the drop-down, select which Voyager engine mode to launch, either **Editor** or **Game**. If **Game** is selected, this setting will over-ride the **Launch PIE on startup** setting (if it is selected).

- **Lucid Driver for XPression Path** (if you've chosen an XPression engine)

The path to the location of the **Lucid Driver for XPression** executable file.

OR

Unreal Engine Path (if you've chosen a Voyager renderer)

The path to the location of the Unreal Engine executable file.

- **Extra Command Line Parameters**

Enter an extra command line parameter for the renderer being loaded.

- **Switchboard Listener Path** (if you've chosen a Voyager engine)

Use the **Browse** button to locate and select the **Switchboard Listener** executable file.

Use the **Start** and **Stop** buttons to start and stop the **Switchboard Listener**.

- **XPression Projects Paths** (if you've chosen an XPression renderer)

The path to the location of your XPression Studio projects (**.xpf** files).

OR

Voyager Projects Paths (if you've chosen a Voyager renderer)

The path to the location of your Voyager projects (**.uproject** files).

- **View All**

Opens a window displaying every project contained in the folders shown in the **Projects Paths** pane.

- **Add Path**

Adds the path to a project folder to the **Projects Paths** pane. It is only necessary to add the root folder. **RVS Engine Service** will find every project file within that folder.

- **Delete Path**

Deletes a path to a project folder from the **Projects Paths** pane.

Log

The **Log** panel displays a record of activities in RVS Engine Service.

Green text indicates normal activities.

Red text indicates unsuccessful connections or operations.

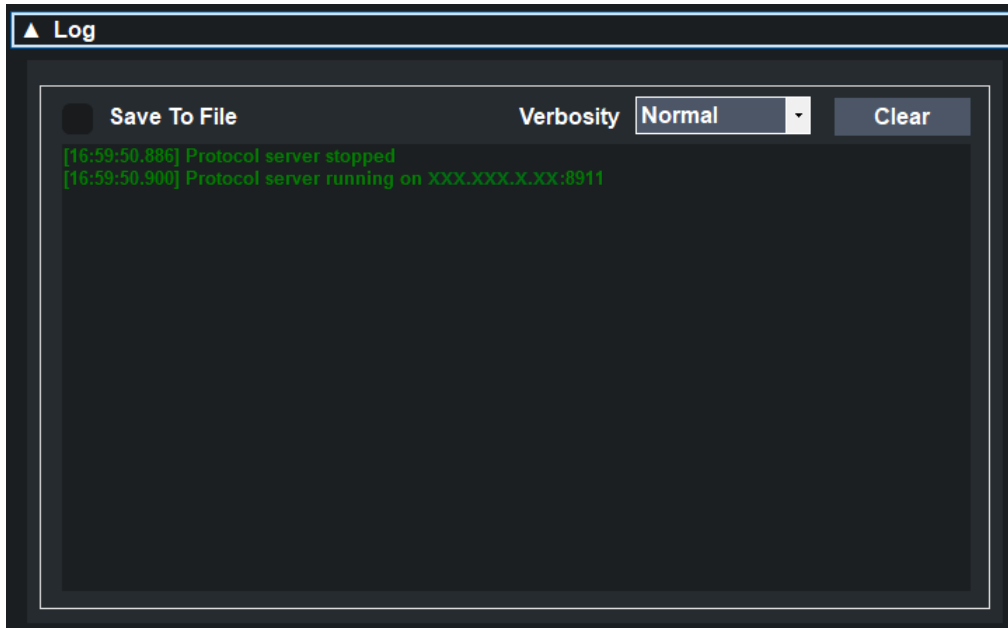

RVS Engine Service - Log

The **Log** settings are described below:

- **Save to File**

When checked, saves a copy of the current contents of the log to the RVS Engine Service folder.

The default location is **C:\ROSS\Lucid\Renderer Service**.

- **Verbosity**

Use the drop-down to select how much detail you want to see in the log.

- **Clear**

Clears the current log entries.

About

The **About** panel provides the version number of RVS Engine Service and the copyright information.

Lucid MOS Service

Lucid MOS Service is a component that allows MOS published Lucid events to be seen and added to a story in a Newsroom Control System (NCS). Lucid MOS Service automatically detects changes in the Lucid Studio project files and resends the data to the XPression Gateway.

The XPression Gateway must be running and configured to connect with Lucid MOS Service.

Lucid MOS Service and **Lucid Studio** need to be running on the same computer, so that **Lucid MOS Service** can access the locally stored project (**.uxp**) files.

For information on establishing communication between Lucid MOS Service and the XPression Gateway, see [XPression Gateway Setup](#).

For more information on the MOS workflow setup and operation, see the *XPression Distributed Workflow User Guide*.

Launching Lucid MOS Service

The first time you launch Lucid MOS Service, a **Windows Security Alert** message appears and **Windows Defender Firewall** will block the application. This message does not appear on hardware provided by Ross Video.

To unblock Lucid MOS Service:

- In the **Windows Security Alert** message, select **Private networks, such as my home or work network** and then select **Allow access**.

You won't see this message again.

Exploring the Lucid MOS Service Interface

The Lucid MOS Service has four drop-downs:

[Settings](#)

[MOS](#)

[Log](#)

[About](#)

Settings

The **Settings** panel provides the fields and controls described below:

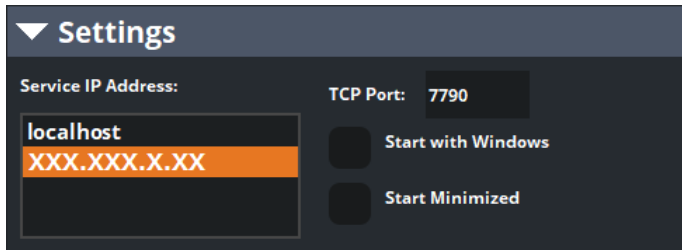

Lucid MOS Service - Settings

- **Service IP Address**

The IP address of the machine running Lucid MOS Service. Select from an automatically generated list of available IP addresses.

- **TCP Port**

The port to be used by Lucid MOS Service.

A default port is automatically entered here, but can be changed if it is already in use. The same port number needs to be configured in the XPression Gateway in the [Lucid Studio Integration](#) panel.

If you change the port number in one MOS event, it will be changed for all MOS events.

The default port number is **7790**.

- **Start with Windows**

When checked Lucid MOS Service will be started automatically when Windows is launched.

- **Start Minimized**

When checked, Lucid MOS Service will be minimized to the task bar at startup.

MOS

The MOS panel allows you to set the path to your Lucid Studio project and to check that communication is established with the **XPression Gateway**.

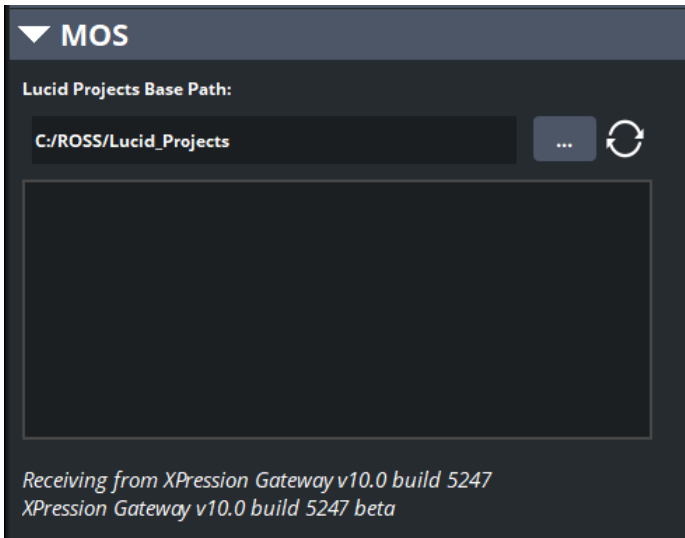

Lucid MOS Service - MOS

To set the path to your Lucid Studio project:

- In the **Lucid Projects Base Path** section, select the **Browse** button to the right of the **Path** field to navigate to the folder where your Lucid Studio project is located, typically **C:/ROSS/Lucid_Projects**.

A list of the Lucid Studio projects in that folder that contain MOS objects is displayed.

At the bottom of this panel, a message is displayed indicating whether or not Lucid MOS is receiving data from the **XPression Gateway**.

Log

The **Log** panel displays a record of activities in Lucid MOS Service.

Green text indicates normal activities.

Red text indicates unsuccessful connections or operations.

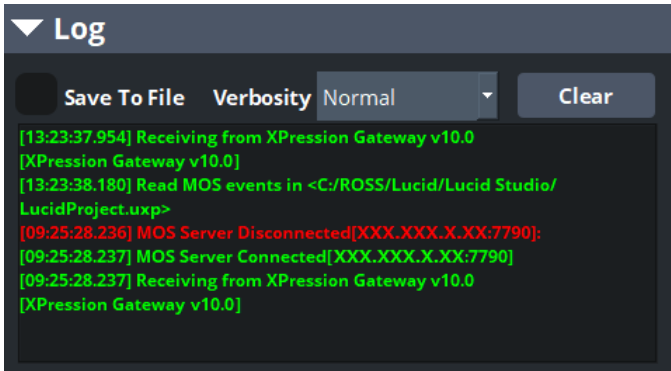

Lucid MOS Service - Log

The **Log** settings are described below:

- **Save To File**

When checked, saves a copy of the current contents of the log to the Lucid MOS Service folder. The default location is **C:\ROSS\Lucid Studio\MOS Service**.

- **Verbosity**

From the drop-down, you can select how much detail you want to see in the log.

- **Clear**

Clears the current log entries.

About

The **About** panel provides the version number of Lucid MOS Service and the copyright information.

Lucid Studio and DashBoard

When DashBoard has been enabled in Lucid Studio and a connection has been established, you can trigger events and recall existing position presets from the DashBoard panel. You can also create a custom DashBoard panel containing only those events and item positions you will be using (see [Creating a Custom DashBoard Panel](#)).

Exploring the DashBoard Interface

The default panel contains two tabs, [Events](#) and [Position](#).

Events

The **Events** tab contains one sub-tab for each page in the **Events** panel in Lucid Studio. The sub-tabs are labeled with the name of the event page or a number, if it is the default name. Each sub-tab contains a table of 20 buttons, corresponding to the **Event** buttons in Lucid Studio.

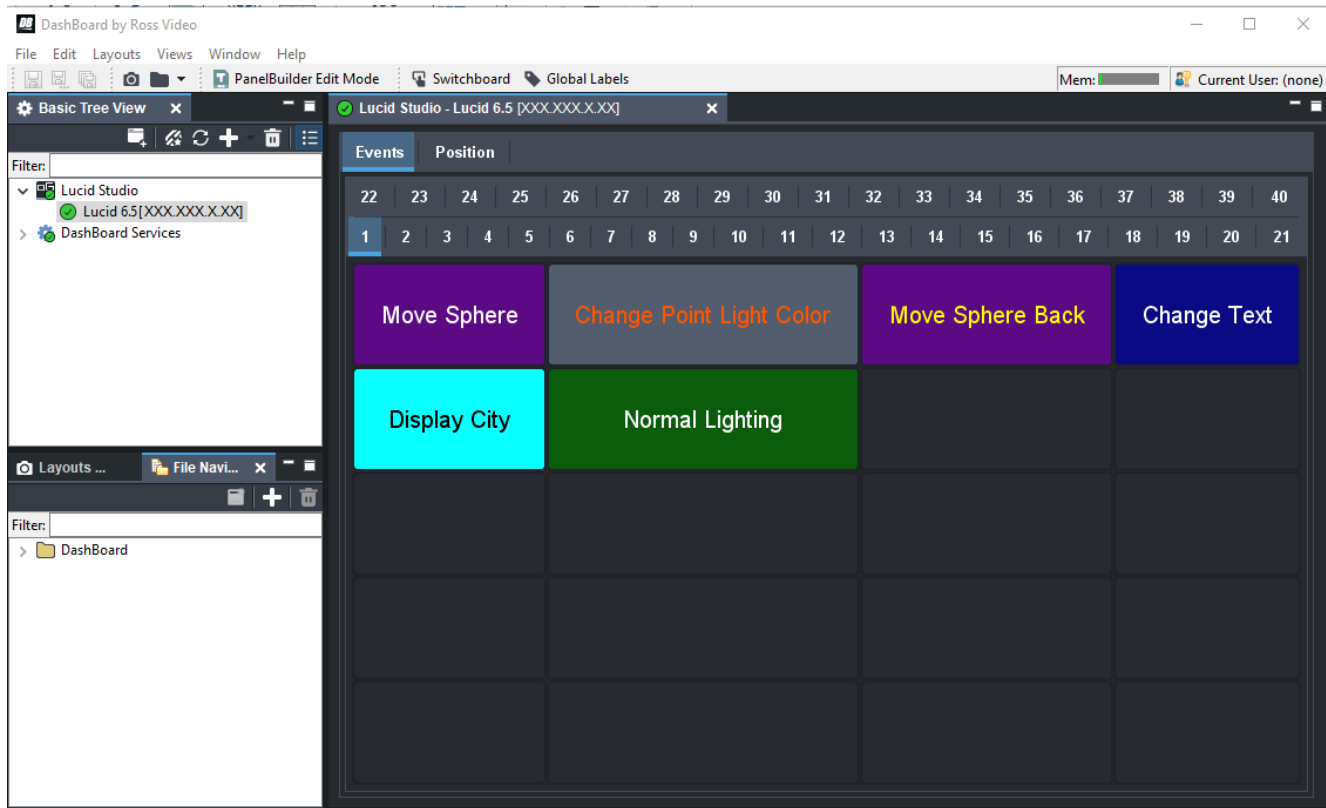

Dashboard - Lucid Studio Events Panel

To execute an event:

- Select the **Event** button.

Position

The **Position** tab contains one sub-tab for each item in the **Position** panel of Lucid Studio. The sub-tabs are labeled with the scene name and the names of the items.

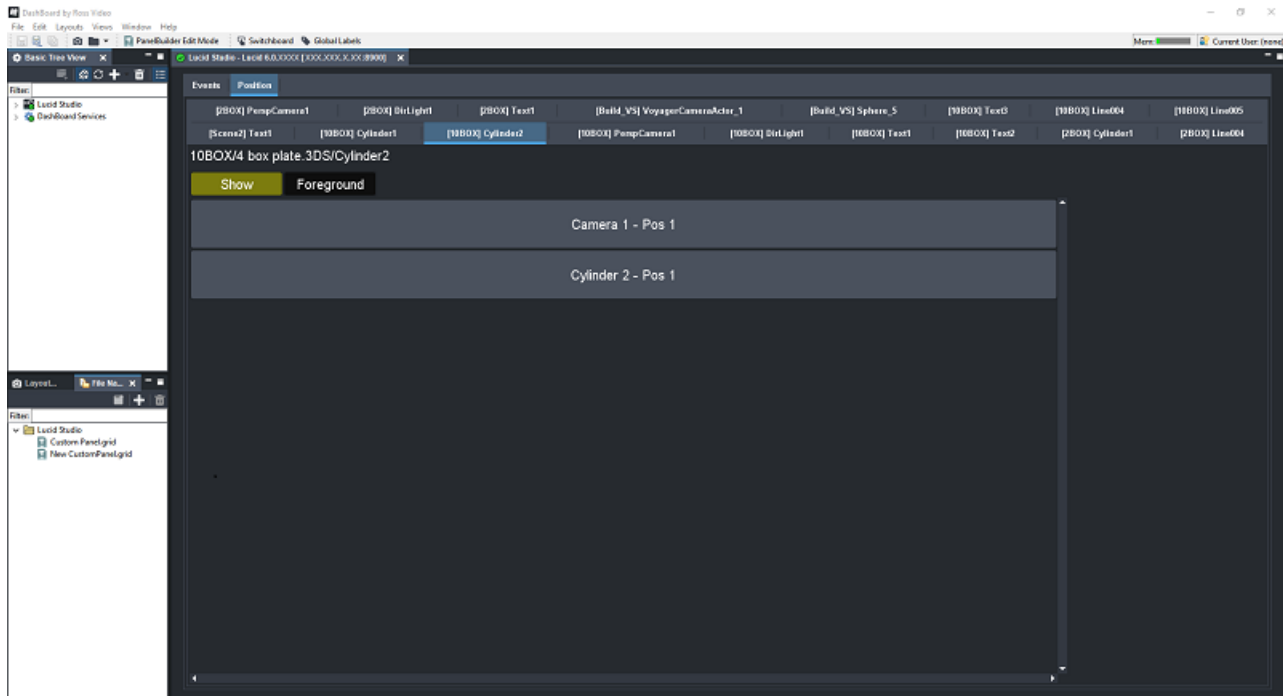

DashBoard - Lucid Studio Position Panel

Each sub-tab contains a label with the full hierarchy of the item and a list of positions that have been created in Lucid Studio for the item.

- Object, text and character items contain a **Show/Hide** button and a **Background/Foreground** button.
- Camera items contain an **Active** button only.
- Light items contain a **Show/Hide** button only.

To move an item to a new position:

- Select on the position in the list in the sub-tab for that item.

To make a different camera active:

- Select the **Active** button in the sub-tab for that camera.

To make an item visible/invisible:

- Select the **Show/Hide** button in the sub-tab for that item.

To move an item to the foreground or background:

- Select the **Background/Foreground** button in the sub-tab for that item.
- In Voyager renderers, this applies only in **External Compositing** mode.

Creating a Custom Dashboard Panel

You can create a custom Dashboard panel containing only the **Event** buttons and **Position** tabs you want. You will need to display the custom panel and the default panel side by side to add the buttons and tabs. You can also resize and move the **Event** buttons and **Position** tabs in the custom panel.

This section contains the following procedures:

[To create a custom Dashboard panel](#)

[To display the default and custom panels together](#)

[To add event buttons to the custom panel](#)

[To add item positions to the custom panel](#)

[To resize a button or item](#)

[To move a button or item](#)

To create a custom Dashboard panel:

1. In Dashboard, select **File > New > New CustomPanel File**.

The **Create new CustomPanel File** window opens.

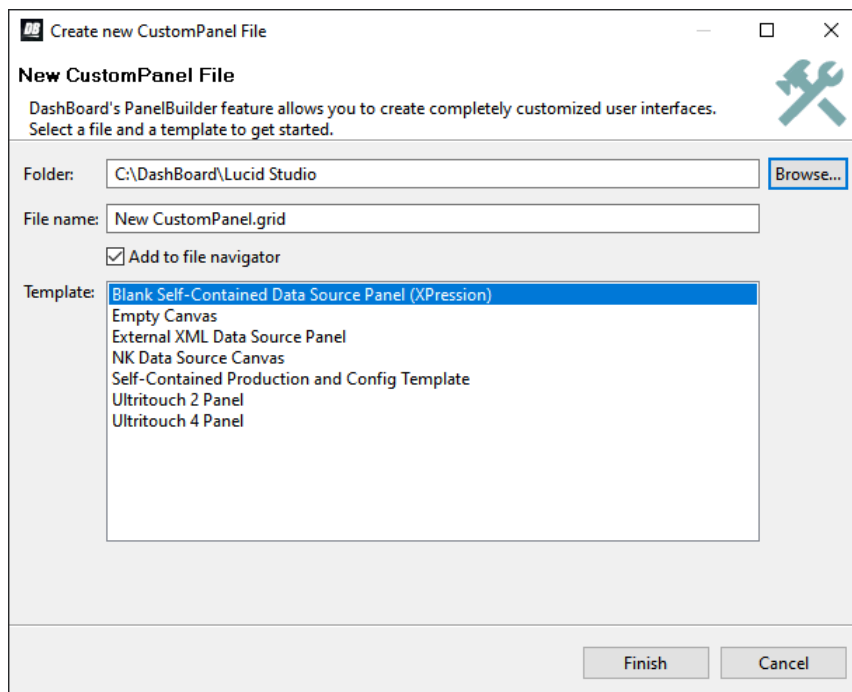

Create New CustomPanel File

2. In the **Folder** field enter a path to the folder where the custom panel file will be stored.
3. In the **File** name field, enter a name for the custom panel.
4. Select the **Add to file navigator** checkbox.
5. From the **Template** list, select **Blank Self-Contained Data Source Panel (XPression)**.
6. Select **Finish**.

A tab for the custom panel appears beside the default Lucid Studio tab.

6. In the **Insert into ABS Component** window, select the **Extract individual controls (radio buttons, toggle buttons, etc.)** checkbox and select **OK**.

The button is copied into the custom panel.

7. To select a button from a different **Event** page, select a header tab in the default panel and then select the **PanelBuilder Edit Mode** icon again and select another event tab.
8. Then select the **PanelBuilder Edit Mode** icon and select and drag an **Event** button to the custom panel.
9. In the **Insert into ABS Component** window, select **OK**.

The button is copied into the custom panel.

To add item positions to the custom panel:

1. Select a header tab in the default panel and select the **Position** tab.
2. If you are unable to select the **Positions** tab, select the **PanelBuilder Edit Mode** icon in the menu bar and then select the **Position** tab.
3. Select the tab for the item you want to add to the custom panel.
4. Select the **PanelBuilder Edit Mode** icon again

A green overlay appears on the panel.

5. Select and drag each item you want to the custom panel.

Each component of the item (label, **Show/Hide** button, **Background/Foreground** button, **Active** button and each position) can be added individually or you can add the complete item by selecting an empty area so that the green highlight frames the whole item.

If you copy an entire item, it is copied with no additional step required.

If you copy an individual component of an item, you'll get the **Insert into ABS Component** window.

6. Select the **Extract individual controls (radio buttons, toggle buttons, etc.)** checkbox and select **OK**.

The component is copied into the custom panel.

7. To select items from a different tab, select a header tab in the default panel, select the **PanelBuilder Edit Mode icon** again and select another item tab.
8. Then select the **PanelBuilder Edit Mode** icon and select and drag the item you want to the custom panel.

To resize a button or item:

1. In the **Custom Panel**, select the button or item or component of an item.
2. Select and drag a corner of the item to re-size it.

To move a button or item:

1. In the **Custom Panel**, hover over the button or item or component of an item you want to move.
2. Then select and drag the item to a new position.

Lucid Studio and Voyager

The Lucid Plugin is the interface between Lucid Studio and Voyager. When running Lucid Studio with the Voyager renderer, you need to set up communication between Lucid Studio and Voyager.

Once communication is established, you'll also be able to use the Lucid Studio logic function to query Voyager and have Voyager return the values that can be set from the Renderer Logic function block.

You'll also be able to control the appearance and position of objects in Voyager and control a Voyager XR setup.

The following topics are covered in this section:

[Configuring the Lucid Plugin in Voyager](#)

[Using Voyager Blueprints with Lucid Studio Logic](#)

[Using the Send Message Node](#)

[Using Lucid Studio to Control a Voyager Multiple Display System](#)

[Starting a Voyager nDisplay Project from Lucid Studio](#)

Configuring the Lucid Plugin in Voyager

This is done in the Lucid Plugin inside Voyager. This section contains the following procedures:

To open the Lucid Configuration panel:

- In Voyager, in the main menu, select the Lucid icon.

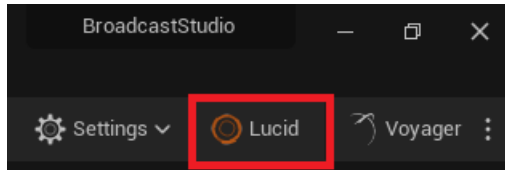

Voyager - Main Menu

The Lucid Plugin opens.

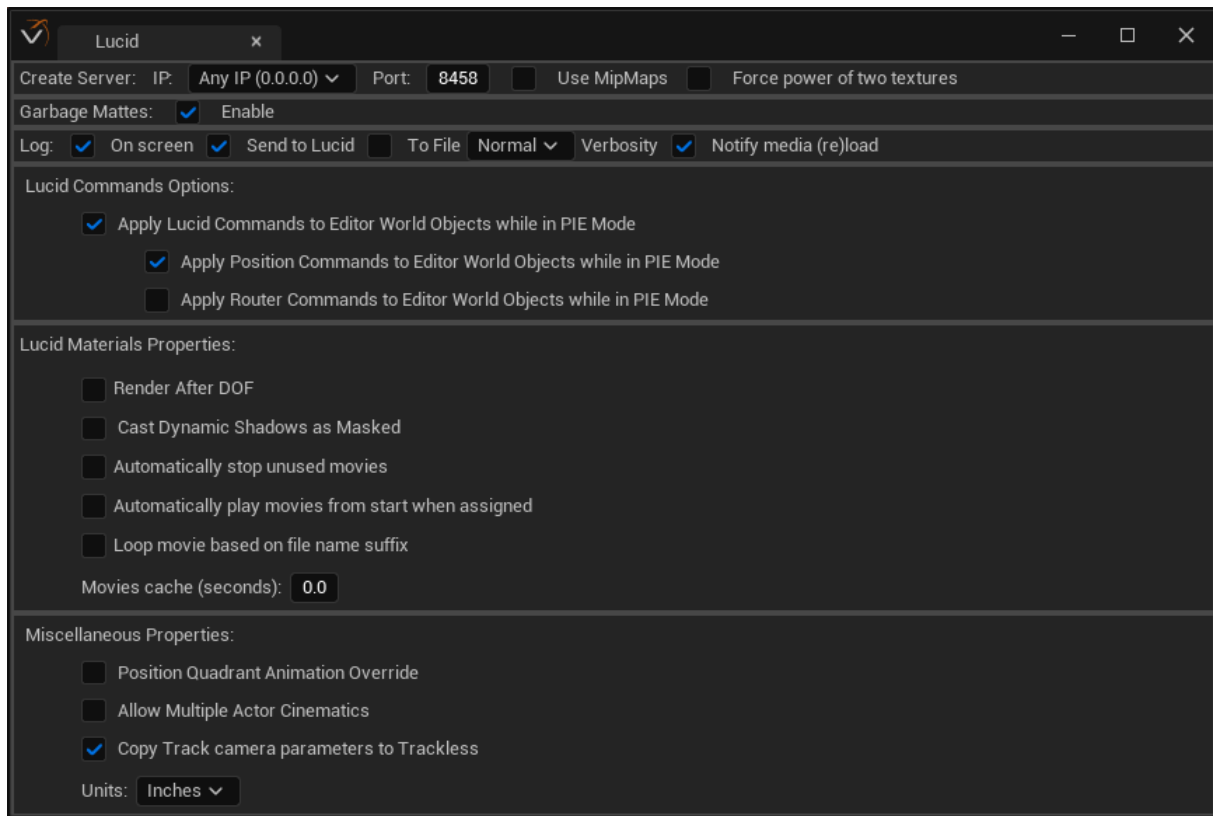

Lucid Plugin for Voyager

To configure the Create Server settings:

1. In the **Create Server** section, from the **IP** drop-down, select the IP address of the computer on which Voyager is running.

Alternatively, you can select the **Any IP** option, which means that the plugin will listen for connections on any IP address available on the network, in the selected port.

2. In the **Port** field, enter the port on which the Lucid Studio plugin will listen for Lucid Studio commands.

This is the same port as is defined when adding a renderer in [Lucid Studio > Server > Lucid Tracks and Renderers > Add Lucid Track/Renderer](#), in the **Operate Port** field.

3. Select the **Use MipMaps** checkbox, to generate mipmaps for textures.

Using mipmaps increases rendering speed and reduces stress on the CPU.

Default is unchecked.

4. Select the **Force power of two textures** checkbox to convert textures that are not sized to “power of two” dimensions to “power of two” dimensions, so mipmaps can be used.

This setting is only applicable if **Use MipMaps** is enabled.

To enable Garbage Mattes:

- Select the **Garbage Mattes** checkbox to create garbage mattes in the renderer.

Garbage mattes are only enabled by this setting. They need to be configured in [Garbage Mattes](#), to take effect.

Default is checked.

To configure the Log settings:

1. In the **Log** section, select the **On screen** checkbox if you want to show the Lucid Studio log on the Voyager screen.

2. Select **Send to Lucid** if you want to send a log to Lucid Studio.

And/Or

Select To File to save the log in a file.

The log will be saved in the project **Saved > Logs** folder.

3. From the **Verbosity** drop-down, select the amount of detail you want to get in the log.

4. Select **Notify media (re)load** to send Lucid a notification when all media has been loaded/reloaded.

To configure the Lucid Commands Options:

1. Select the **Apply Lucid Commands to Editor World Objects while in PIE Mode** checkbox to enable the **Lucid Commands** option.

Clearing this checkbox will apply Position and Router commands only while in Editor mode.

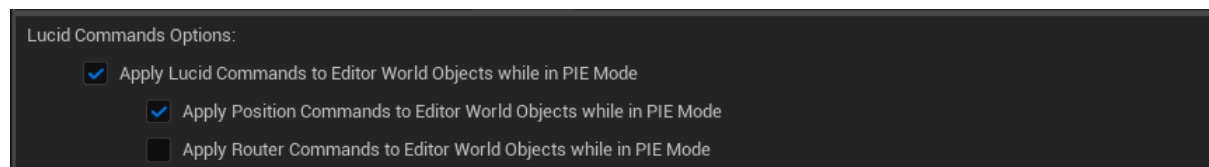

2. Then select one or both of the following options:

- **Apply Position Commands to Editor World Objects while in PIE Mode.**
- **Apply Router Commands to Editor World Objects while in PIE Mode.**

To configure the Lucid Materials Properties:

1. In the **Lucid Materials Properties** section, in the **Unlit Emission Factor** field, enter a value or use the arrows to increase or decrease the amount of emission for unlit Lucid materials.

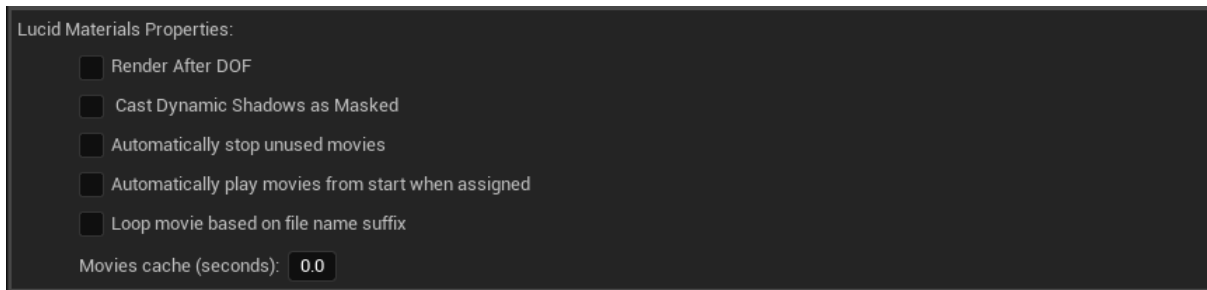

2. Select the **Render After DOF** checkbox to enable **Render After DOF** on Lucid materials. 5 This requires a restart.
3. Select the **Cast Dynamic Shadows as Masked** checkbox to have Lucid materials cast dynamic shadows as masked.
4. Select the **Automatically stop unused movies** checkbox to stop and reset to the beginning, any movie that is not being used in any actor.
5. Select the **Automatically play movies from start when assigned** checkbox to play movies from the beginning when assigned in Lucid Studio (unless they are already visible in another object).
6. Select **Loop movie based on file name suffix** to override the Loop command in Lucid. This will set the Loop command to TRUE if the movie name ends in "_LOOP" or FALSE if the movie name ends in "_NOLOOP".
7. In the **Movies cache (seconds)** field, use the arrows to set a time (in seconds) for which movies should be played in the background, on load.

This improves the first run in certain (usually high resolution) movies, but it takes longer for the project to fully load.

To configure Miscellaneous Properties:

1. In the **Misc** section, select the **Position Quadrant Animation Override** checkbox to allow an active animation to be overridden in Lucid Studio with an event that controls the same item.

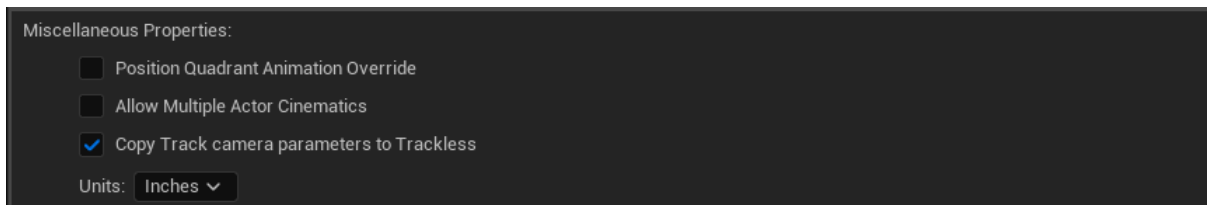

2. Select the **Copy Track camera parameters to Trackless**, if you want any virtual camera in the set to have the same camera properties as the broadcast camera.

OR

Clear the checkbox if you want to ensure that the virtual camera(s) you set up in the editor retain their own properties.

3. From the **Units** drop-down, select the unit of length to be used by the Lucid Plugin, either **Inches** or **Centimeters**.
4. Select the **X** in the top-right corner to close the Lucid Plugin configuration tab when finished.

Changes are automatically saved.

Using Voyager Blueprints with Lucid Studio Logic

Here are some tips for using Voyager blueprints with Lucid Studio logic:

- Start Voyager (in game or editor mode) first and then start Lucid Studio, so that Lucid Studio will correctly parse the blueprint containing the Lucid Studio node.
- The Lucid Studio node names created in Voyager will only be seen in Lucid Studio if Voyager is in game mode or in editor mode.
- If the name in a Lucid Studio node is changed, the old name will still be visible in Lucid Studio until Voyager is restarted.
- The Lucid Studio blueprint nodes in Voyager won't appear in the **Variable** drop-down list in the **Renderer Logic** block until the blueprint has been played in Voyager once.
- Give the Lucid Studio blueprint node in Voyager a meaningful name to make finding it in the drop-down list easier.



Lucid Studio Blueprint Node in Voyager

To set up a Voyager blueprint to work with Lucid Studio logic:

1. In Voyager, select **Blueprints** and select the level blueprint.
2. Right-click in the **Blueprint Event Graph** and in the **Search** field, type `Lucid`.

If you are using a project created in a previous version of Voyager, the nodes will have been called UX nodes. In this case, you can type `UX` to access those nodes, but they will now be called Lucid. The new Lucid nodes are backwards compatible with the older projects that used UX nodes.

3. From the results, select a Lucid node to use to send the object variables to Lucid Studio.

It is preferable to use the **Async** nodes.

The available nodes are shown in the image below:

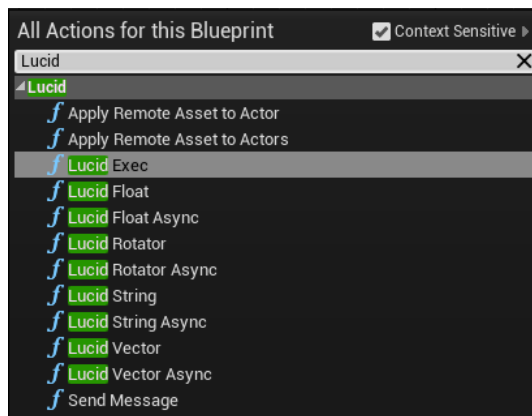

Voyager - Lucid Studio Nodes

4. Select the **Var Name** field and enter a name so that you can identify the node in Lucid Studio.



Voyager - Name Lucid Studio Node

5. Make the node part of the **Exec** flow in the blueprint (see example below).

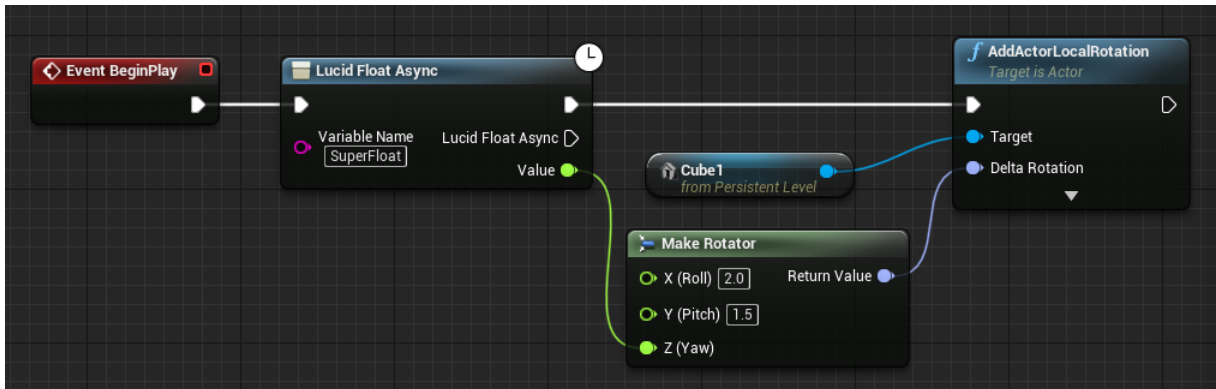

Voyager - Add Lucid Node to Exec Flow

To add a logic graph for the blueprint in Lucid Studio:

1. Add the Voyager renderer to Lucid Studio Server, if you haven't already done so.

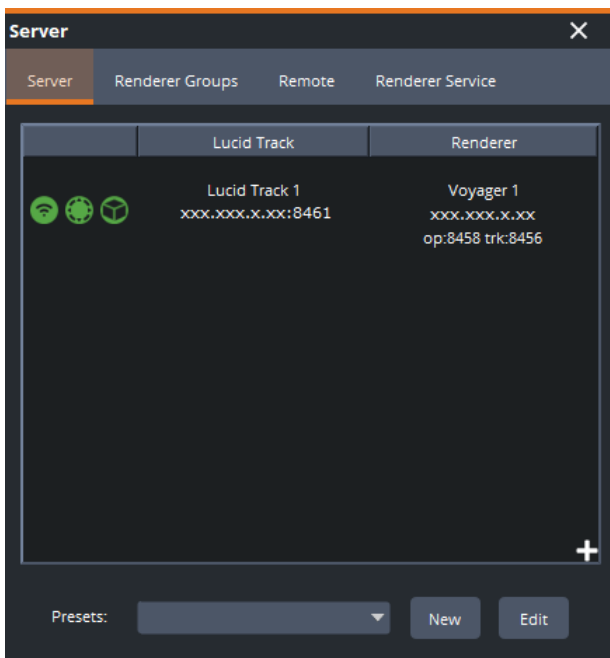

Add Voyager Renderer

See [Server](#) for instructions on adding a renderer.

- In Lucid Studio, in the **Logic** panel, select the **+** icon in the bottom-right corner of the pane to open a new workspace.

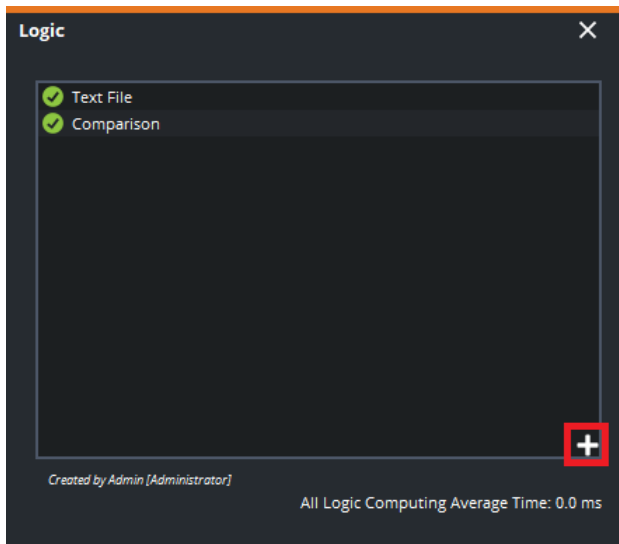

Lucid Studio - Logic Panel

- Right-click in the workspace to add a **Renderer Logic** function block to access the Voyager Blueprint variables.

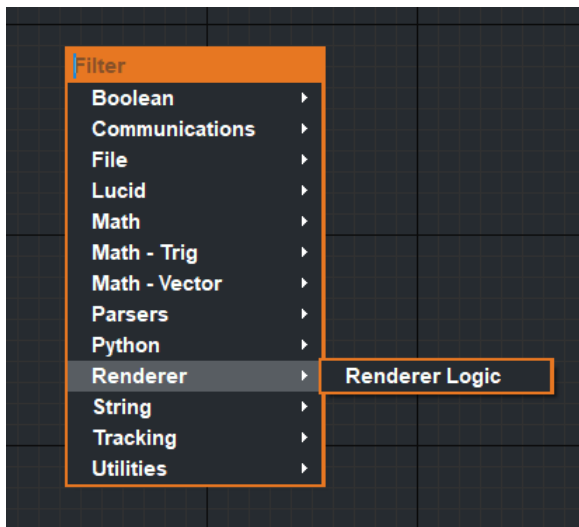

Lucid Studio - Renderer Logic Function Block

- In the **Renderer Logic** function block, from the **Renderer** drop-down, select the Voyager renderer containing the Blueprint variables you want to access.

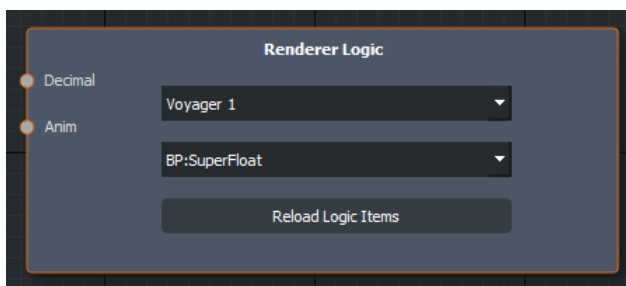

Renderer Logic - Select Renderer

The Voyager project needs to be playing and contain a Lucid Studio node for the Voyager renderer and logic items to appear in the drop-down.

5. In the **Renderer Logic** function block, from the **Variable** drop-down, select the Lucid Studio blueprint variable that you set up in Voyager.

The input of the function block depends on the type of variable selected.

For example, if you created a **Lucid Studio Float** node in Voyager, the required input would be a decimal.

6. If you want to animate the Blueprint variable, connect a decimal source function block to the **Anim** input and enter the duration of the animation (in seconds).
7. In the **Name** field of the workspace, enter a name for your logic flow and then select **Save** and **OK**.

The logic graph for your Voyager blueprint is added to the **Logic** pane.

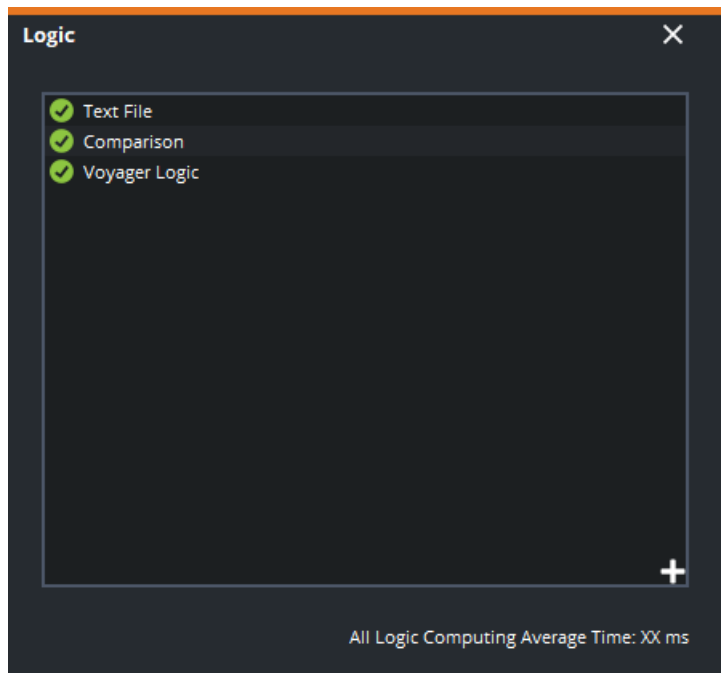

Voyager Blueprint Logic Graph Added

Using the Send Message Node

The **Send Message** node allows you to send a message over the network to a **TCP** or **UDP** server. In the example below, when the "0" key is pressed, Voyager will send the message entered in the **Message** field to the specified server.



Lucid Studio Send Node

The Lucid Studio **Send** node requires the following information:

- **IP address** — either entered in the **IP** field or connected to a node that feeds the value
- **Port number** — either entered in the **Port** field or connected to a node that feeds the value
- **Is TCP** — when checked, the message type is **TCP**, when unchecked, the message type is **UDP**
- **Message** — enter the text of the message you want to send or connect to a node that feeds the message

If sending Smart GPI commands, the command needs to terminate with a **CRLF**, i.e. **Shift + Enter** in Windows.

Using Lucid Studio to Control a Voyager Multiple Display System

You can use Lucid Studio to start a Voyager project that outputs to multiple screens simultaneously, using one or more Voyager engines. Such projects require the Voyager Switchboard Launcher installed on the master node and the Voyager Switchboard Listener installed on the cluster nodes.

The Voyager Switchboard Launcher will listen to RossTalk messages from Lucid Studio at **TCP** port **7798** and relay those messages to the cluster nodes.

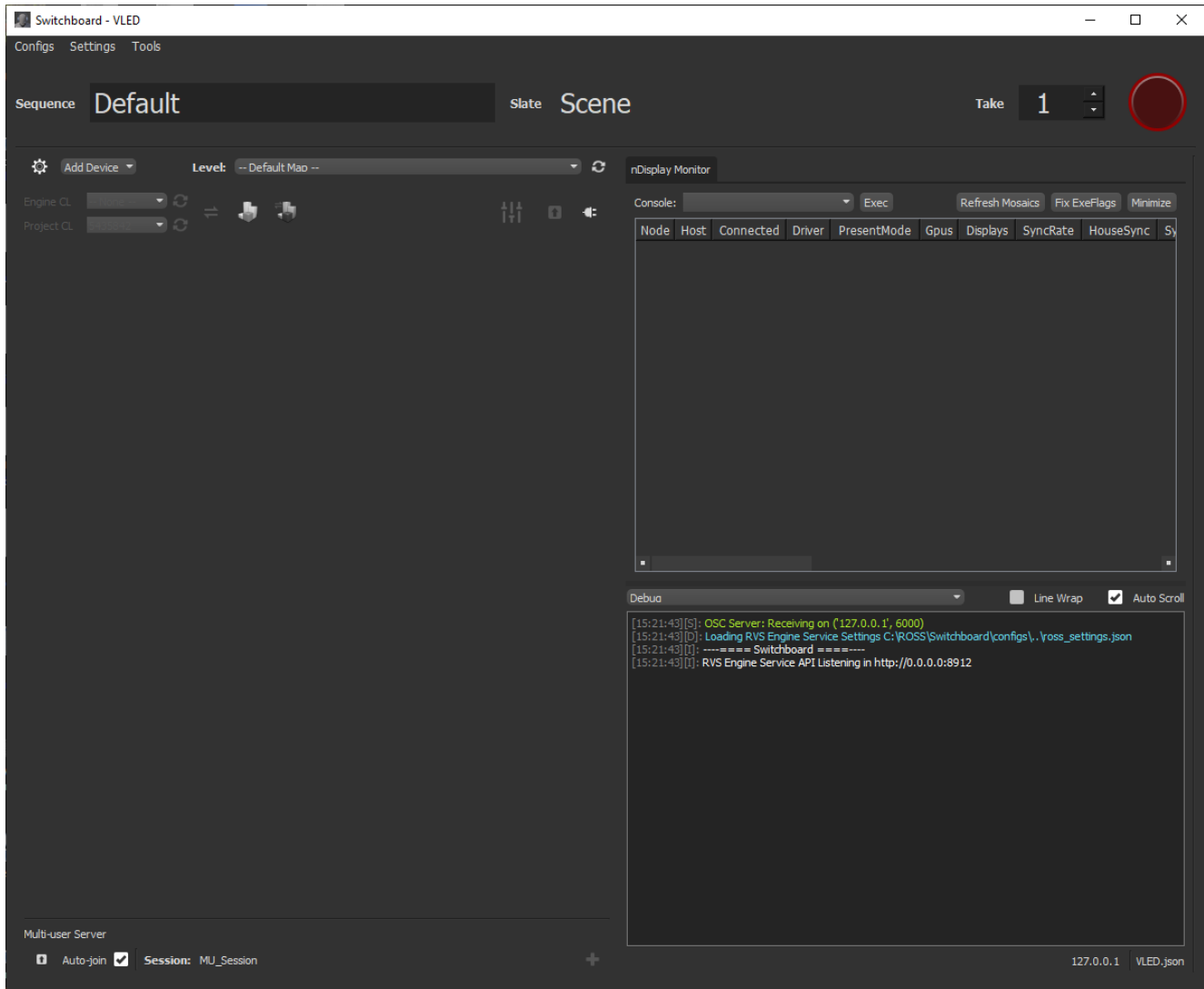

Voyager Switchboard Launcher

The following RossTalk messages can be used to communicate with the Voyager XR system:

- GPI 01: executes the **RUN** command
- GPI 02: executes the **KILL** command
- GPI 11: minimizes the Voyager XR Launcher window
- GPI 12: restores the Voyager XR Launcher window
- GPI 101 to 199: selects project 1 to 99 (project 1 being the first project in the **Applications** pane of the Voyager Switchboard Launcher, project 2 being the second project, etc.)

Starting a Voyager nDisplay Project from Lucid Studio

You can launch your nDisplay project remotely from Lucid Studio, either from the **Server** panel or from a **Misc Lucid** event, using the standalone Switchboard Launcher application, installed on the same machine as Lucid Studio. There needs to be a Voyager Switchboard Listener application running on the same machine as each Voyager machine, for this to work.

The following procedures will enable this feature:

[Configuring the Voyager Switchboard Launcher](#)

[Launching the Voyager nDisplay project from Lucid Studio](#)

[Launching the Voyager nDisplay project from a Misc event](#)

To configure the Voyager Switchboard Launcher:

1. Launch the Voyager nDisplay project you want to use and ensure that **Switchboard Listener** is running on the Voyager machine.
2. Then launch **Switchboard Launcher** from the desktop icon on the Lucid Studio machine.

The **Add new Switchboard Configuration** dialog opens, already populated with the configuration for the current project.

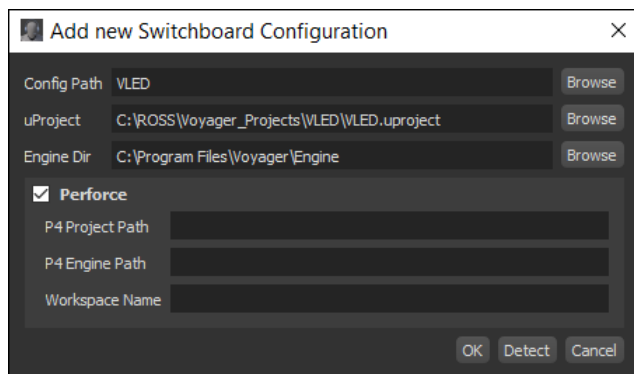

Add New Switchboard Configuration

3. Select **OK**.

The **Switchboard Launcher** opens.

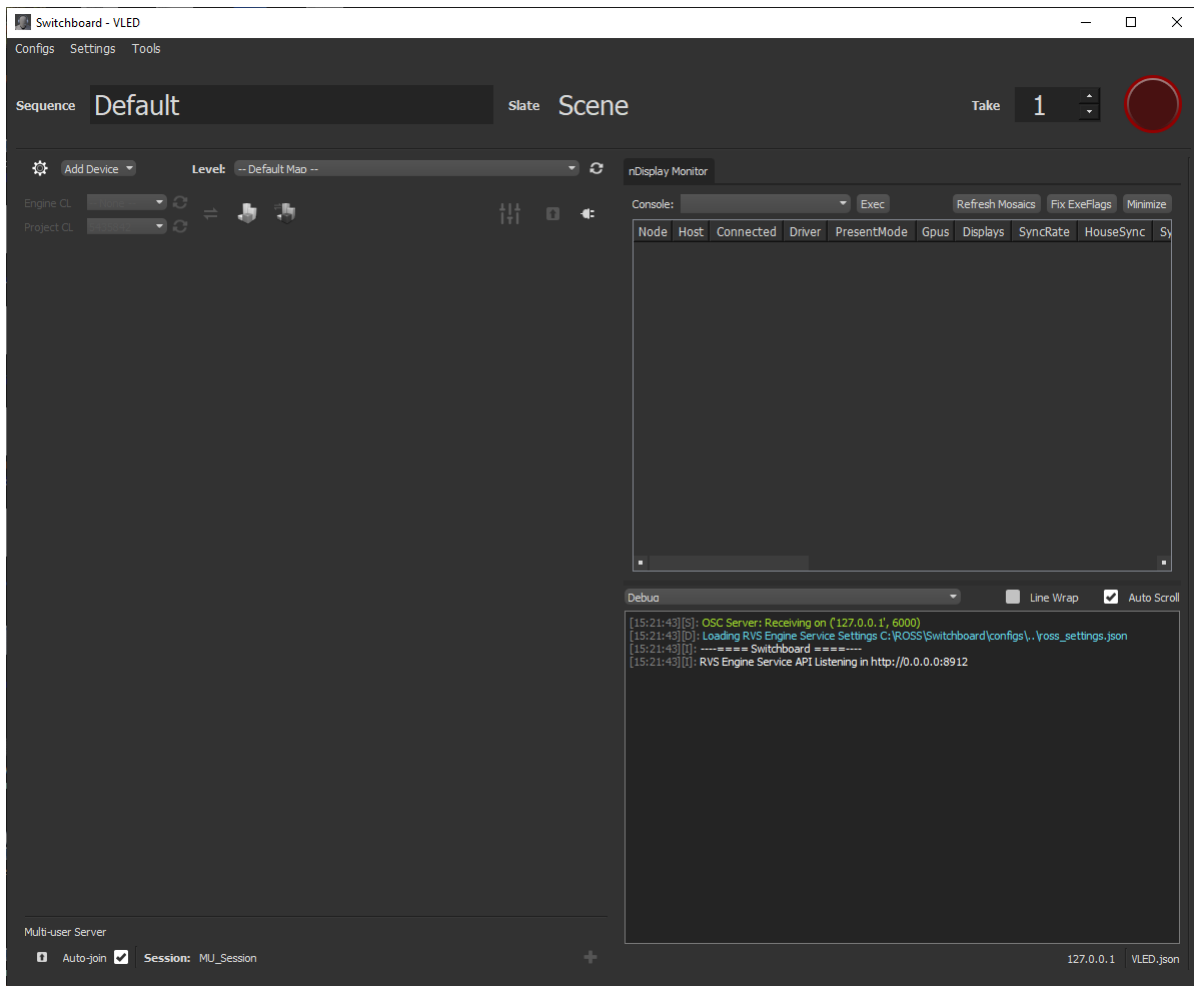

4. In the **Switchboard Launcher**, select **Tools > RVS Engine**.

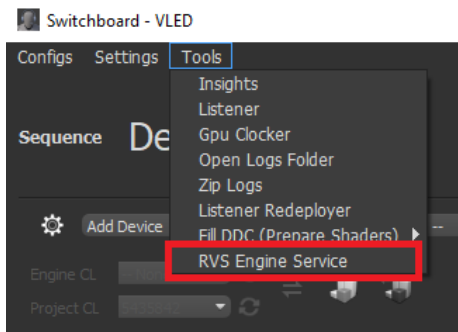

Voyager Switchboard - Select RVS Engine Service

The **RVS Engine Service** dialog opens.

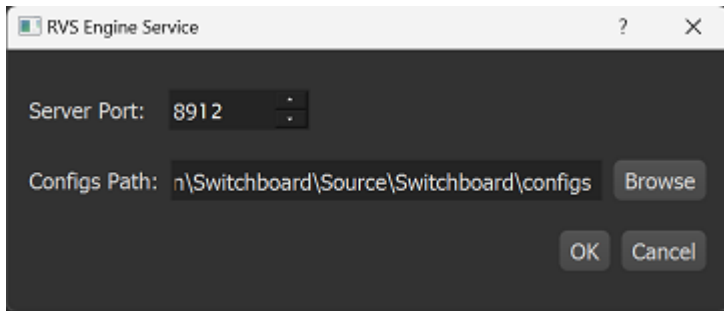

Voyager Switchboard - RVS Engine Service

5. In the **RVS Engine Service** dialog, enter the port on which to communicate.

This should be the same port as is indicated in the log in the RVS Engine Service API Listening in <http://0.0.0.0:XXXX> line.

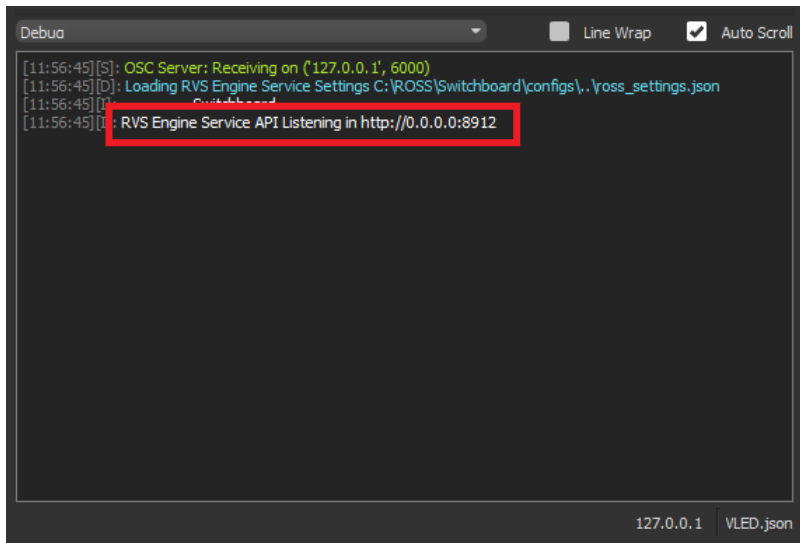

Voyager Switchboard - Log

6. In the **Configs** path field, select **Browse** and then navigate to and select the folder containing the configuration (**.json**) files.

7. From the **Add Device** drop-down, select **nDisplay**.

The **Add nDisplay Device** dialog opens.

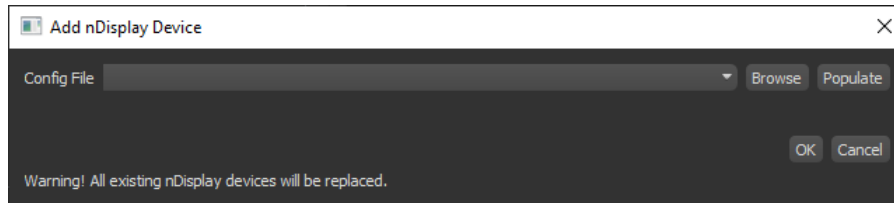

8. Select **Browse** beside the **Config File** field and in the **Select nDisplay config file** window, navigate to the content folder of your nDisplay project and select the nDisplay config file (**VLEDStage.ndisplay** or **VLED_Stage.ndisplay**).

A typical file path might be: **C:\ROSS\Voyager Projects\VLEDProject\Content**.

9. Then select **OK**.

The nDisplay device is added to the Launcher.

10. Repeat Steps 5 to 7 to add additional nDisplay devices, as required.

To configure a project launcher in Lucid Studio:

1. In Lucid Studio, in the **Server** panel, select the **Renderer Service** tab.
2. In the bottom-right corner of the **Renderer Services** pane, select the **+** icon.

The **New Lucid Service** dialog opens.

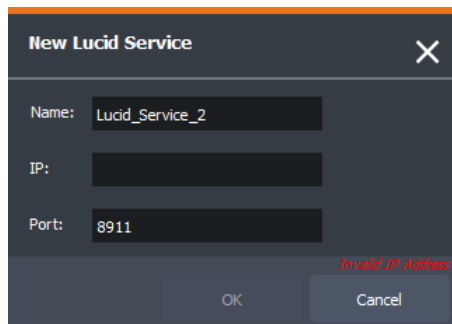

New Lucid Service

3. In the **Name** field, replace the default name with a name for the service (e.g., nDisplay Launcher).
4. In the **IP** field, enter the **IP** address of the machine on which Switchboard Launcher is running.

5. In the **Port** field, enter the port number on which Lucid Studio will be communicating with Switchboard Launcher.

This port must be the same as the port that was configured in Switchboard Launcher in the [RVS Engine Service](#) dialog and cannot be in use elsewhere.

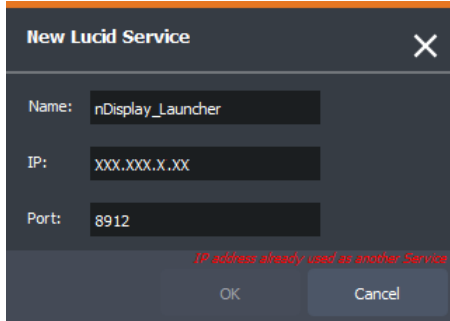

New Lucid Service - nDisplay

6. Then select **OK**.

The new service is added to the **Renderer Services** pane.

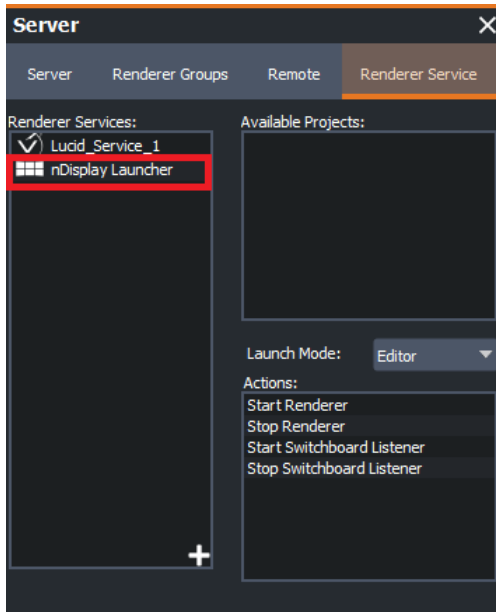

New Renderer Service Added - nDisplay

To launch the nDisplay project:

1. In the **Renderer Service** tab, in the **Renderer Services** pane, double-click the project launcher you created in the previous procedure.

In the **Available Projects** list, you will see the projects that are available to the selected service.

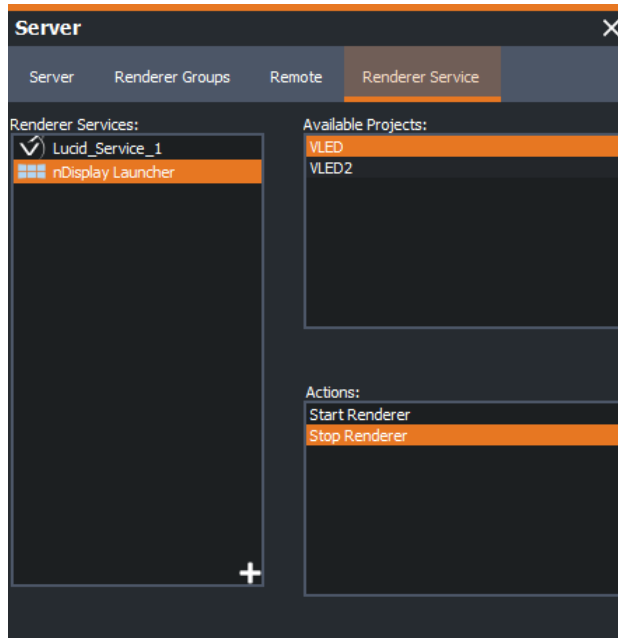

nDisplay Renderer Service - Available Projects

2. In the **Available Projects** pane, select the nDisplay project you want to launch.
3. Then, in the **Actions** pane, double-click **Start Renderer**.

Your nDisplay project is launched in Voyager and in Lucid, in the **Available Projects** pane, you can see that the selected project is running.

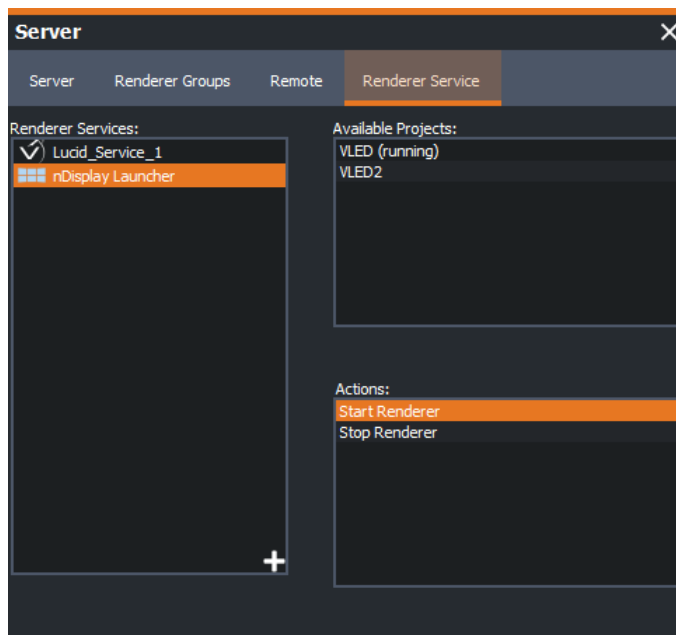

nDisplay Renderer Service - Project Running

Starting Switchboard Listener

Starting with RVS Engine Service v7.1.0.117 and Lucid v7.1.2817, you can start Switchboard Listener from a Renderer Service set up in the [Server](#) panel or directly from [RVS Engine Service](#). You can also start Switchboard Listener from a [Misc](#) event.

In all cases, you first need to configure a Switchboard Listener Service.

To configure a Switchboard Listener Service:

1. In the **RVS Engine Service** application, select the **Settings** drop-down.

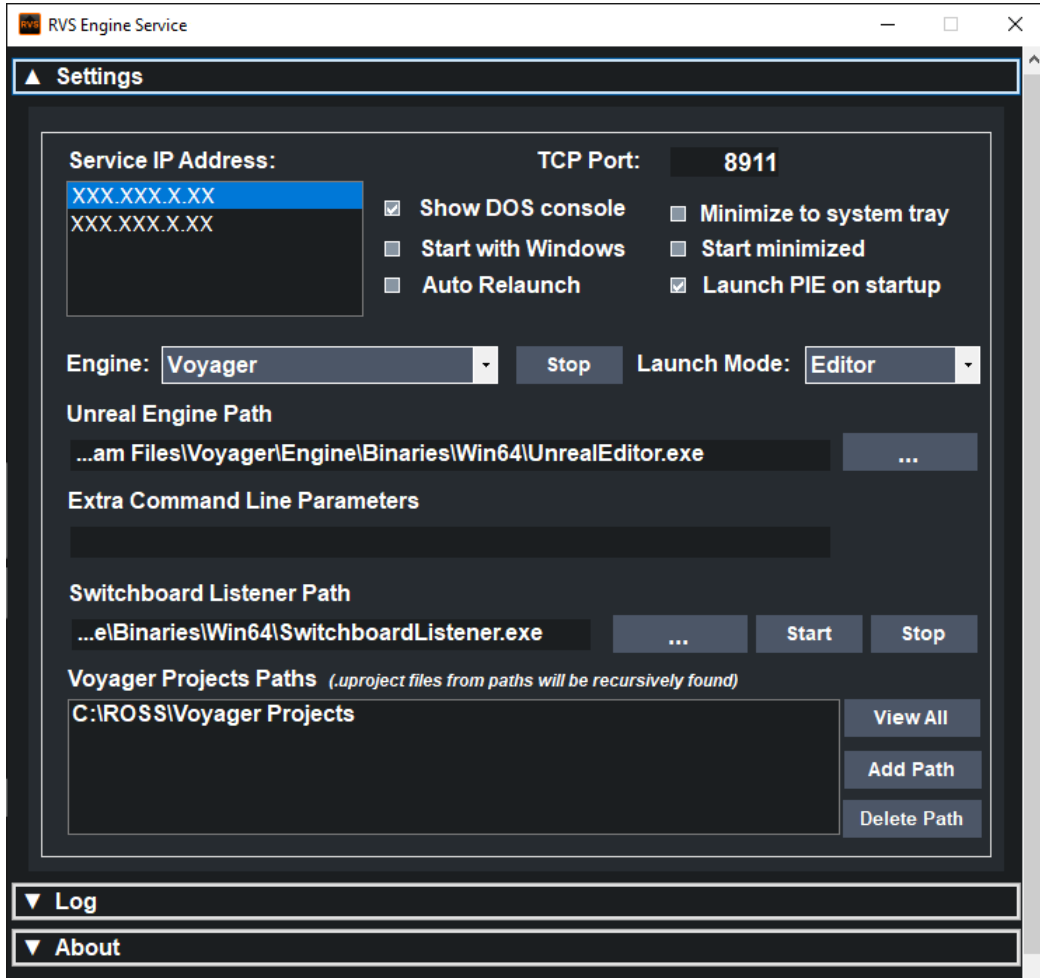

RVS Engine Service - Settings

2. From the **Engine** drop-down, select one of the following options:
Voyager — if you want to start any Voyager project
Switchboard Listener Only — if you only want to start an nDisplay project
3. Select the **Browse** button beside the **Switchboard Listener Path** and navigate to and select the **Switchboard Listener.exe** file, if it is not already selected.
4. In Lucid Studio, in the **Server** panel, select the **Renderer Service** tab.

5. In the bottom-right corner of the **Renderer Services** pane, select the **+** icon.

The **New Lucid Service** dialog opens.

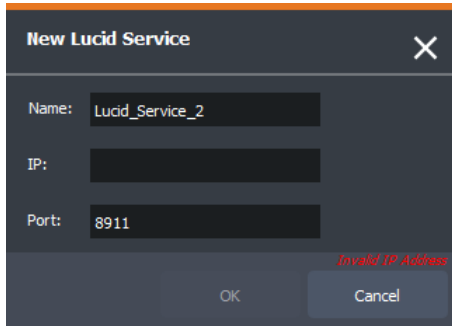

New Lucid Service

6. In the **New Lucid Service** dialog, in the **Name** field enter a name for the service (e.g., SB_Listener).
7. In the **IP** field, enter the IP address of the machine on which Switchboard Listener is installed.
8. In the **Port** field, enter the port number found in **RVS Engine Service** in the **Settings** drop-down (**TCP Port**).

The default port is 8911, but if that port is being used for something else, you will need to enter a different port in both the New Lucid Service dialog and in the RVS Settings.

The Switchboard Listener service is added to the **Renderer Services** pane.

If **Switchboard Listener Only** was selected from the **Engine** drop-down in the **RVS Engine Service** settings, in the **Actions** pane, the options to start and stop Switchboard Listener appear.

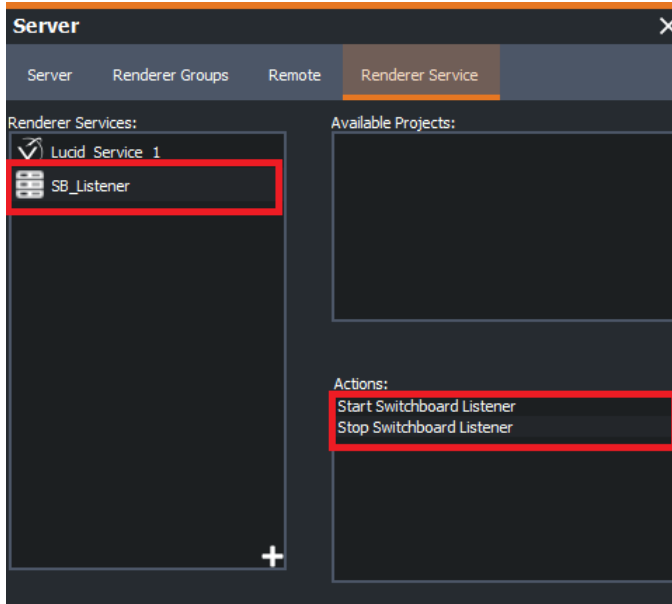

New Switchboard Listener Service Added - nDisplay

If **Voyager** was selected from the **Engine** drop-down in the **RVS Engine Service** settings, then the additional options to start and stop a renderer will also appear in the **Actions** pane.

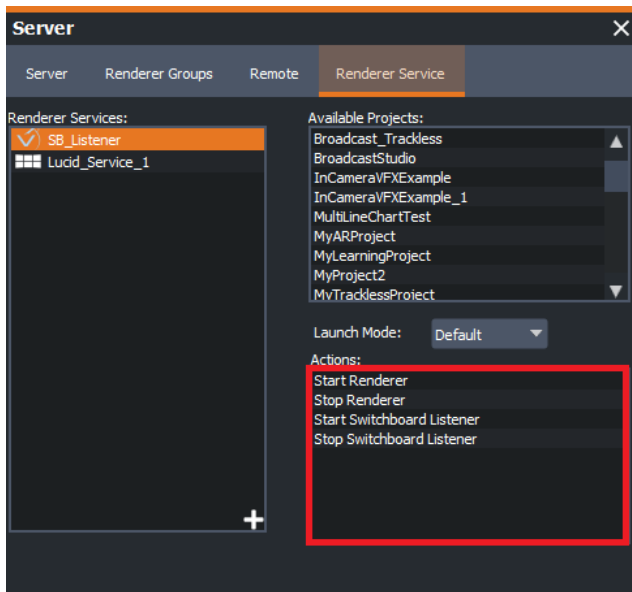

New Switchboard Listener Service Added - All Projects

To start Switchboard Listener from the Server panel:

1. In the **Server** panel, select the **Render Service** tab.
2. In the **Render Services** pane, select the Switchboard Listener service.
3. In the **Actions** pane, double-click **Start Switchboard Listener**.

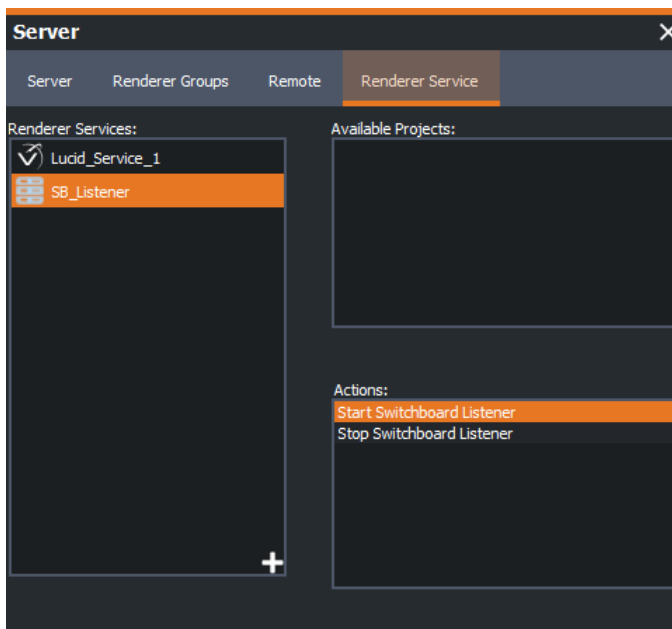

Server - Start Switchboard Listener

Double-click **Stop Switchboard Listener** to close Switchboard Listener.

To start Switchboard Listener from RVS Engine Service:

1. In the **RVS Engine Service** application, select the **Settings** drop-down.
2. From the **Engine** drop-down, select **Voyager**.
3. Select the **Browse** button beside the **Switchboard Listener Path** and navigate to and select the **Switchboard Listener.exe** file, if it is not already selected.
4. Then select **Start** to start Switchboard Listener.

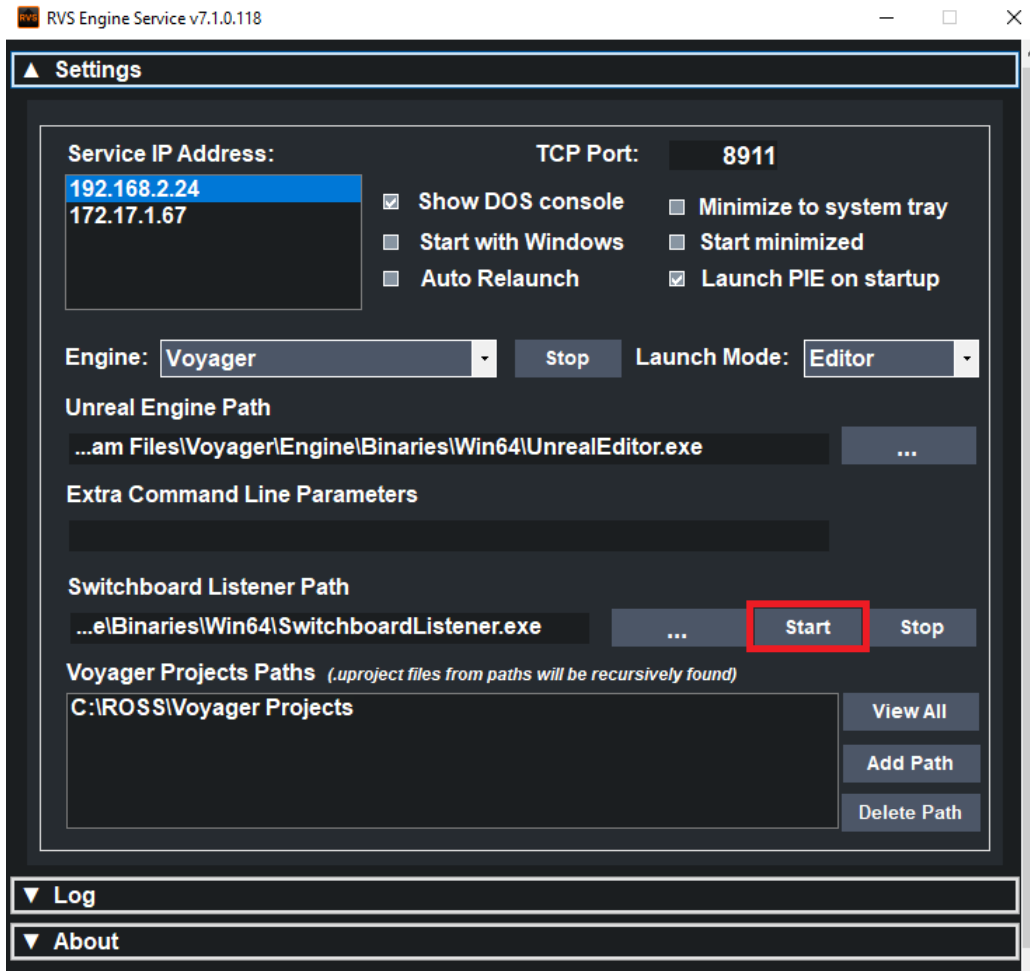

RVS Engine Service - Start Switchboard Listener

Select **Stop** to close Switchboard Listener.

To start Switchboard Listener from a Misc event:

1. Configure a Switchboard Listener service as described in [To configure a Switchboard Listener](#).
2. In Lucid Studio, in the **Events** panel, right-click an **Event** button and in the **General** tab, in the **Name** field, enter a name for the event (e.g., Start Switchboard Listener).

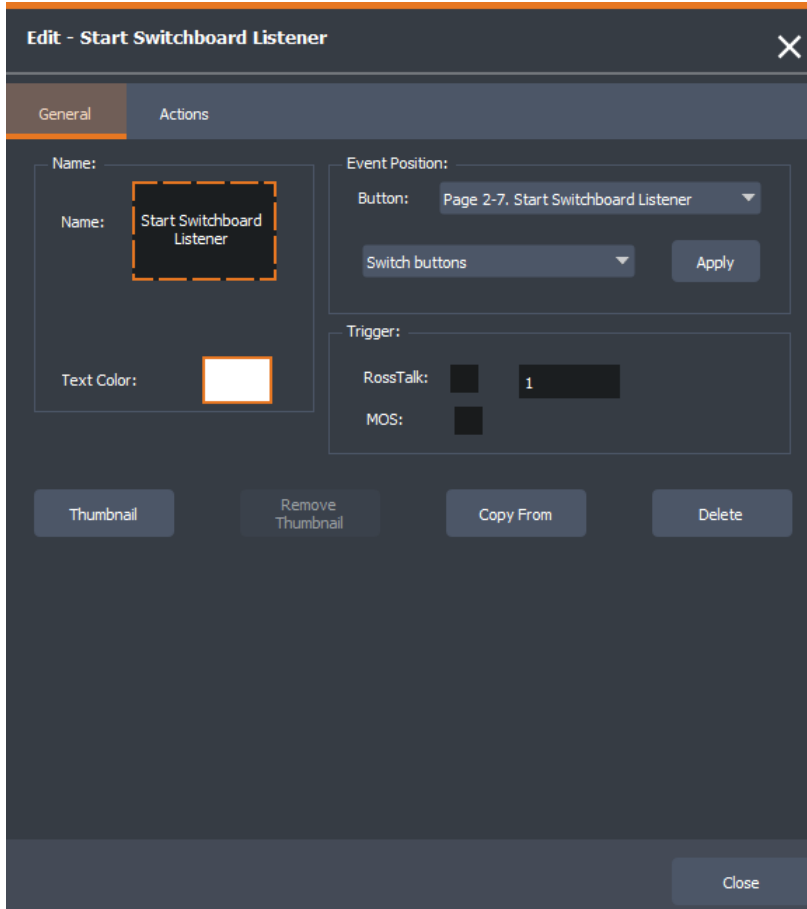

Enter Event Name

3. In the **Actions** tab, in the bottom-right corner of the **Actions to run with the event** pane, select the **+** icon.
4. From the **Type** drop-down, select **Misc**.
5. From the **Command to Run** list, select **Send Command to Renderer Service**.

- In the **Renderer Services** pane, select the **SB_Listener** service and then from the **Action** drop-down, select **Start SB Listener**.

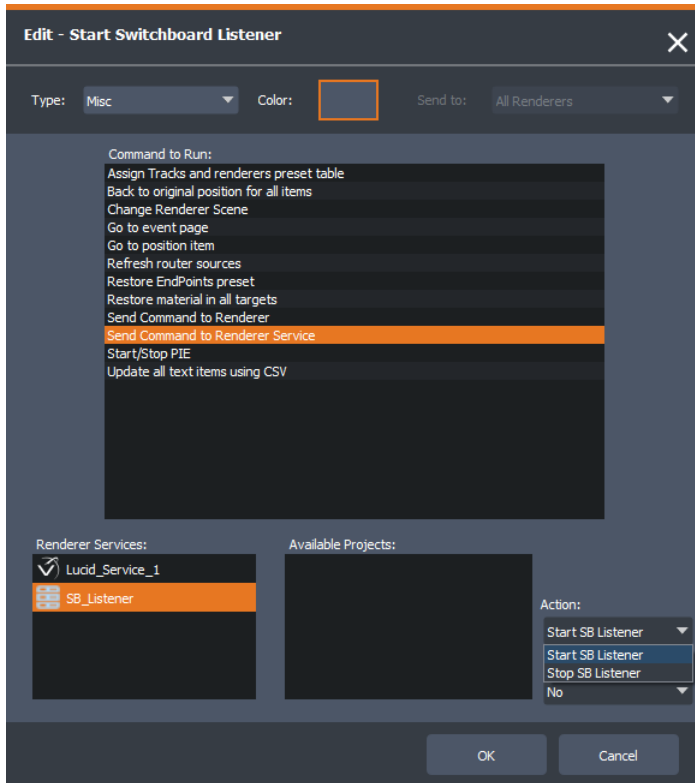

Send Command to Renderer Service

- Select **OK** and in the **Actions** tab, select **Close**.

The event button is configured and can now be used to start Switchboard Listener.

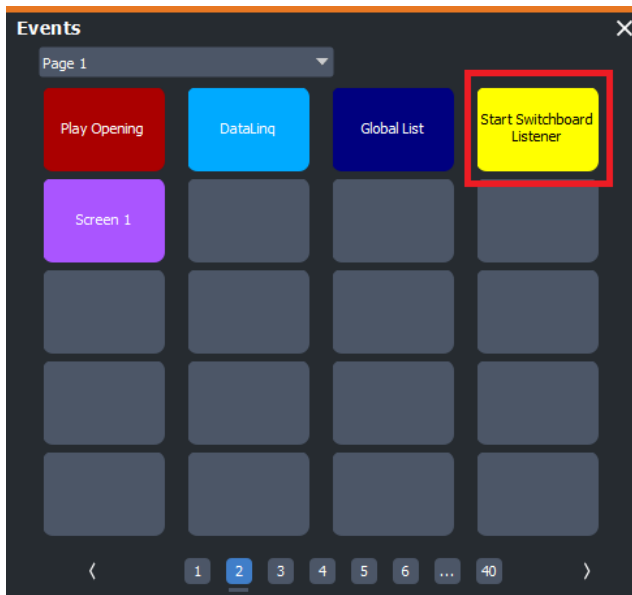

- Repeat Steps to 6 to add an event to stop Switchboard Listener.

XPression Gateway Setup

When Lucid Studio has been configured to communicate with the Newsroom Control System (NCS) through the XPression Gateway, you can play out a MOS story sequence from the **Sequencer** panel in Lucid Studio or through the **XPression Remote Sequencer** or from **Overdrive**.

To configure communication:

1. Launch the Lucid MOS Service application from the desktop icon, if it has not been launched automatically with Windows.

For information about configuring Lucid MOS Service, see [Lucid MOS Service](#).

2. From the Windows **Start** menu, launch the XPression Gateway application.

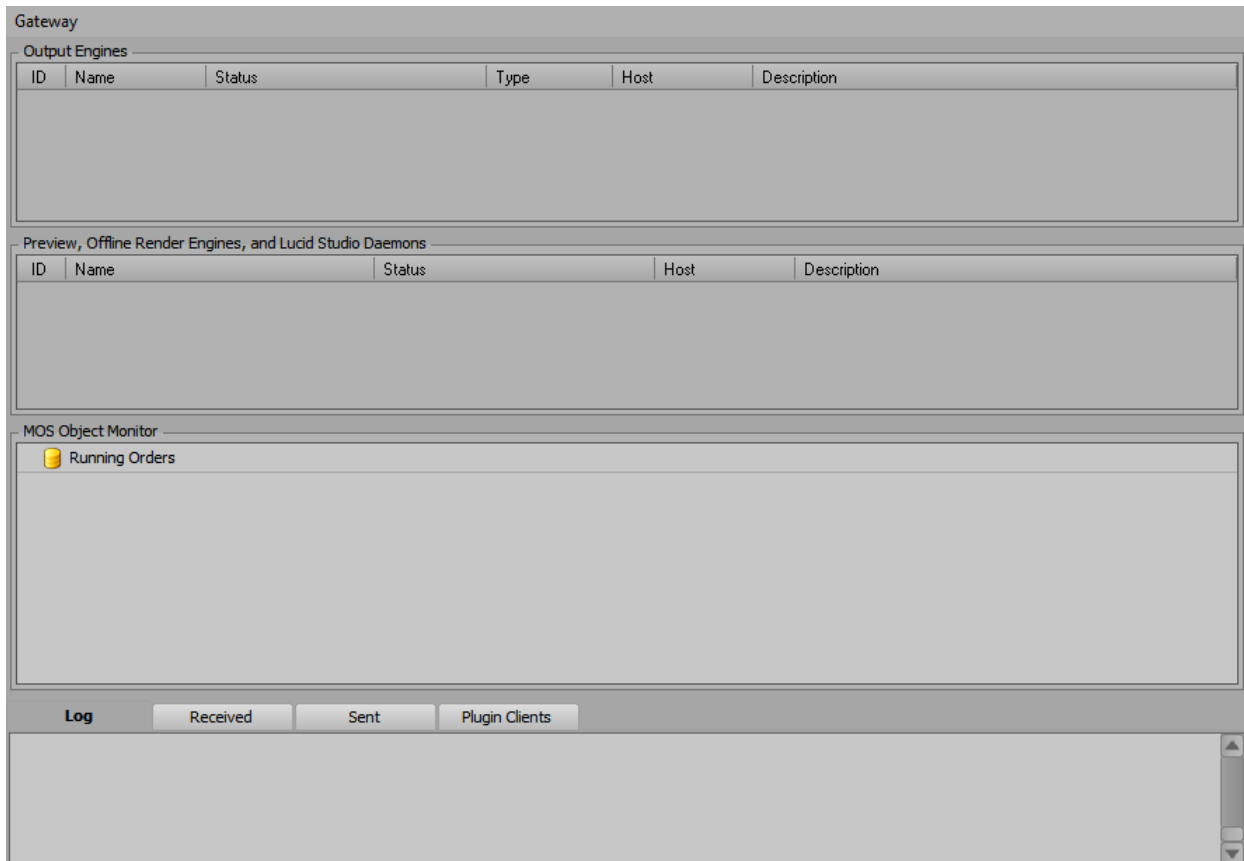

XPression Gateway

3. Select **Gateway > Settings**.

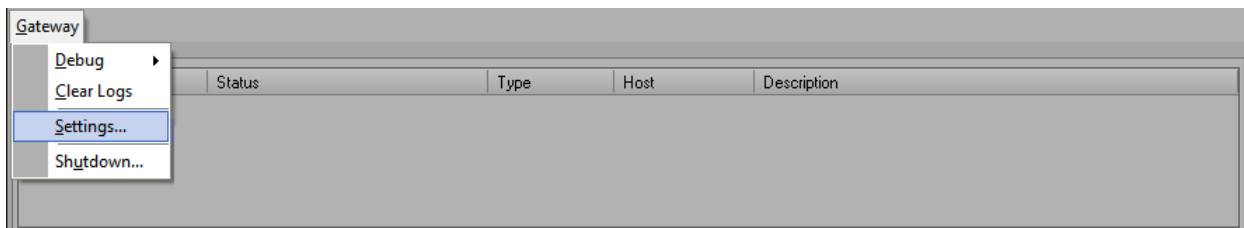

XPression Gateway Settings

4. Configure the Lucid Studio **Integration** settings and enable the Lucid Studio Engine in a **Channel Group** as described in the following sections:

To configure Lucid Studio Integration settings:

To enable the Lucid Studio Engine in a Channel Group:

When you have finished the configuration, the XPression Gateway settings should appear as shown in the image below.

The green dots beside the engine and Lucid MOS Service indicate that they are connected.

The screenshot shows the XPression Gateway settings window. It is divided into several sections:

- Output Engines:** A table with columns ID, Name, Status, Type, Host, and Description. It contains one entry: ID 1, Name Lucid Studio Eng..., Status Connected., Type Lucid Studio, Host localhost:8001, and Description.
- Preview, Offline Render Engines, and Lucid Studio Daemons:** A table with columns ID, Name, Status, Host, and Description. It contains one entry: ID 1, Name Lucid MOS Service, Status Connected., Host 192.168.0.12:8..., and Description.
- MOS Object Monitor:** A section with a yellow folder icon and the text "Running Orders".
- Log:** A section with tabs for "Received", "Sent", and "Plugin Clients". The log shows several entries with timestamps and messages, including "Sent to virtual channel: 1", "sync takeitem", and "Connected to project server".

XPression Gateway Settings Complete

5. In the NCS, publish your stories.

The stories will appear in the **MOS Object Monitor** section of the XPression Gateway settings under **Running Orders**.

The screenshot displays the XPression Gateway configuration interface. It is divided into several sections:

- Gateway**
 - Output Engines**: A table with columns ID, Name, Status, Type, Host, and Description. It contains one entry: ID 1, Name Lucid Studio Eng..., Status Connected., Type Lucid Studio, Host localhost:8001.
 - Preview, Offline Render Engines, and Lucid Studio Daemons**: A table with columns ID, Name, Status, Host, and Description. It contains one entry: ID 1, Name Lucid MOS Service, Status Connected., Host 192.168.0.12:8...
- MOS Object Monitor**: A tree view showing a hierarchy of Running Orders. The root is "Running Orders", which contains a sub-item "[MOS Rundown] DemoNews (Active: Channel Group)". Under this, there are several items: "0001: Story1", "0002: Play Video 1:", "0004: MOS Pause:3.26", "0005: Election Promo:", "0007: Story2", and "0008: Story 3".
- Log**: A section with tabs for "Received", "Sent", and "Plugin Clients". The "Received" tab is active, showing a list of log messages with timestamps and details of operations like "Sent to virtual channel", "sync takeitem", and "Connected to project server".

XPression Gateway with Running Orders

To configure Lucid Studio Integration settings:

1. From the **Settings** list on the left side, select **Lucid Studio Integration**.

The **Lucid Studio Integration** configuration window opens.

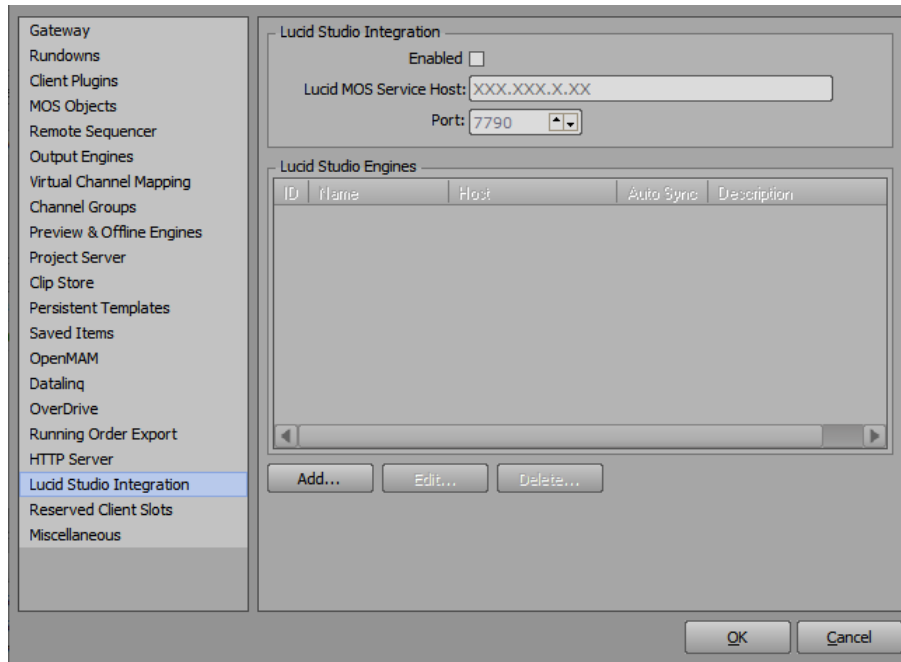

XPression Gateway - Lucid Studio Integration

2. In the **Lucid Studio Integration** section, selected the **Enabled** checkbox.
3. In the **Lucid MOS Service Host** field, enter the IP address of the machine running Lucid MOS Service.
The **Port** is automatically detected.
4. In the **Lucid Studio Engines** section, select **Add**.

The **Lucid Studio Engine** window opens.

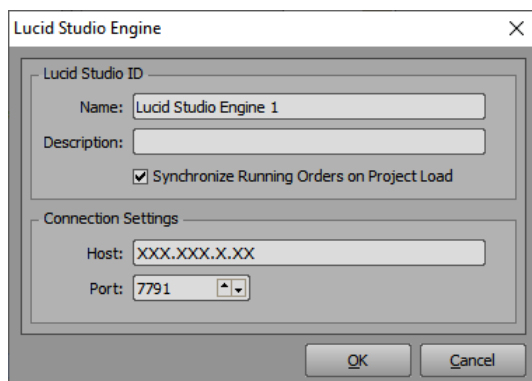

Add Lucid Studio Engine

5. In the **Lucid Studio ID** section, in the **Name** field, enter a name for the engine.
The default name is **Lucid Studio Engine 1** but you can give it any name you wish.
6. In the **Description** field, enter a description, such as the location of the engine (optional).

7. Make sure the **Synchronize Running Orders on Project Load** checkbox is selected.
8. In the **Connection Settings** section, in the **Host** field, enter the **IP** address of the machine running Lucid Studio.

The **Port** number **7791** is entered by default, but can be changed if it is already in use.

The port needs to be the same as the **MOS Server Port** set in the **Lucid** tab of Lucid Studio Setup.

9. Select **OK** to save the settings.

To enable the Lucid Studio Engine in a Channel Group:

1. From the **Settings** list on the left side, select **Channel Groups**.

The **Channel Groups** configuration window opens.

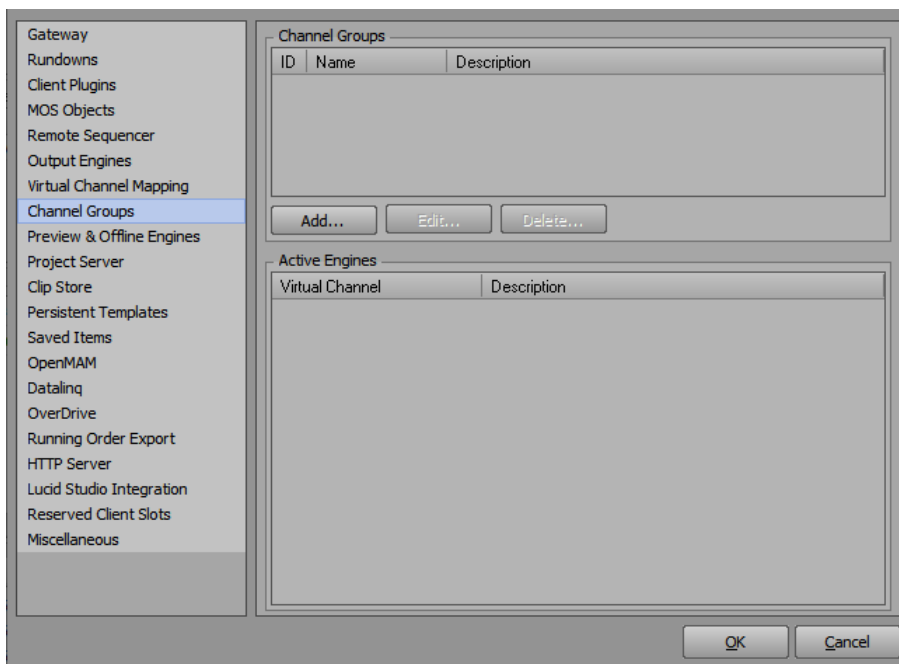

XPression Gateway Settings - Channel Groups

2. In the **Channel Groups** section, select **Add**.

The **Channel Group Settings** window opens.

Virtual Channel	Description
Channel 1	
<input type="checkbox"/> Lucid Studio Engine	Send Lucid Studio scenes to the following systems
<input checked="" type="checkbox"/> Lucid Studio Engine 1	

XPression Gateway Settings - Channel Group Settings

3. Configure the **Channel Group Settings** as follows:

- In the **Channel Group** section, in the **Name** field, enter a name for the channel group you want to use to play your MOS stories.
- In the **Description** field, enter a description for the channel group.
- In the **Allowed IPs** panel, if you want to limit the **Remote Sequencers** that can use the new channel group, select **Add** and enter the IP addresses of permitted Remote Sequencers.

Leaving the field blank allows all **Remote Sequencers** to use that channel group.

- In the **Active Engines** section, select the **Lucid Studio Engine 1** (or whatever you have named the engine) checkbox to send Lucid Studio scenes to the engine and then select **OK**.

4. Select **OK** to save the settings and close the XPression Gateway Settings window.

Communication is now established and can be confirmed by looking at the **MOS** section of the Lucid MOS Service application. There will be a notification saying “**Receiving from XPression Gateway**” with the version and build number as shown in the image below.

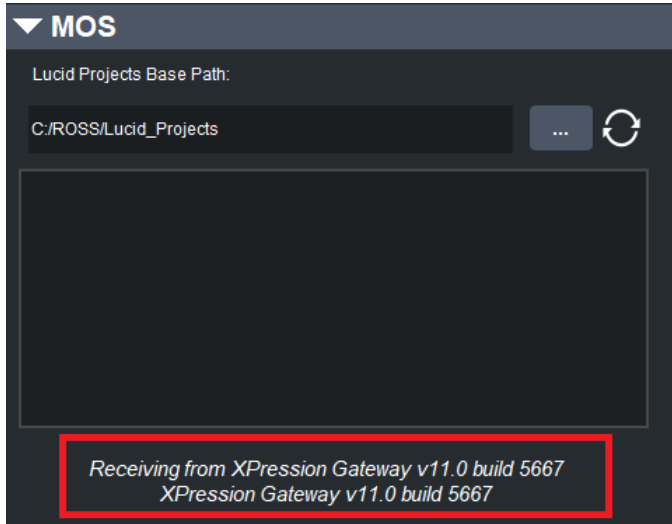

XPression Gateway and Lucid MOS Communication Established

For more information on the MOS workflow setup and operation, see the *XPression Distributed Workflow User Guide*.

Glossary of Terms

A

Augmented Reality - Real set with foreground graphics. No green or blue screen required.

C

Camera Identifier - Circle displayed on a camera status box, displaying that camera's number.

CCD - Charge Coupled Device. Internal camera sensor.

Character Generator - Creates titles or credits for superimposing on edited video footage; using a keyboard for input. May provide recognized font styles, multiple screen storage and background colors for video display.

Chroma Key - An effect in which video from one source replaces video of a specific hue in a second video source. The blue and green hues are most commonly used for chroma keying.

Command Line - Text entry used to prompt the Lucid Studio Driver to open to a specific setting.

Crosshairs - Option to place two perpendicularly intersecting lines in the center of the camera's point of view. Used to adjust camera's focus.

D

Defocus - Tells the driver at which point of perspective to begin blurring the camera's view details.

Delay - Optional pause applied at the beginning of a camera move.

Distance Offset - User-entered values that set the camera focus ranges.

Dolly - Base containing wheels for a Ross Video Furio robotic camera system.

Duration - Time span over which an animated move occurs between the first and last position.

E

Easing - Option to vary camera acceleration and deceleration speeds during a move.

Encoder Min-Max Values - Minimum and maximum encoder values produced by the camera lens for zoom and focus.

F

Feathering - Transition effect applied to virtual wall edges to help them blend with the virtual set.

Field Rate - Driver is sending 60 updates per second to the renderer.

Focus Indicator - Circle displayed on virtual wall status blocks which indicates which matte is in use.

FOV - Field of View.

Frame Rate - Driver is sending 30 updates per second to the renderer.

Furio - Robotic camera system manufactured by Ross Video.

G

Garbage Mattes - Virtual transparent objects used to extend blue and green screens by masking real set objects.

I

IP Address - The numeric Internet Protocol address assigned by the Network Information Center (NIC) that uniquely identifies each computer on the network that uses TCP/IP. The IP address is a 32-bit identifier made up of four groups of numbers, each separated by a period, such as 192.168.0.1.

J

Jib - Crane-like camera mount.

K

Key - An effect produced by “cutting a hole” in background video, then filling the hole with video or matte from another source. Key source video cuts the hole, key fill video fills the hole. The video signal used for cut and fill can come from the same or separate sources.

L

Lock All Cameras - Applies the same set of virtual wall positions to all cameras.

Lucid Studio - Software that allows users to configure and operate a virtual set.

Lucid Studio Driver for XPression - Connects the renderer to Lucid Studio and controls the output of graphics within the virtual set.

Lucid Studio Layout - Contains all of the elements to be executed within Lucid Studio Experience.

M

MOS (Media Object Server) - A protocol used in newsroom control systems.

Moveable Objects - 3D objects to be employed in a virtual set.

N

NCS - Newsroom Control System

Notification Area - Open area at the bottom of the side bar, which displays messages for system related issues.

O

Offset - User setting to set the camera’s limits for moves, focus, pan, tilt and zoom.

P

Pan - A movement where the camera pivots horizontally left or right from a fixed point.

Panel - One of the following elements of the Lucid Studio interface: **Server, Track Setup, Track Operate, Track Grid, Position, Events, Sequencer, Router, Logic, Web Chroma, Color Correction, Video Walls** or **Log**.

Position Control Block - A set of arrows that can be used to change the values of position, rotation, scale and other fields.

Project Configuration File — User-created file containing all elements to be executed in Lucid Studio.

R

Remote Settings - Network configuration settings between the Lucid Driver for XPression and the renderer.

Renderer - Alternate name for the computer system that is generating graphics (for example XPression or Voyager).

RT - RossTalk software that interfaces XPression with Lucid Studio.

S

Status Bar - Vertical bar on the right side of the Lucid Studio interface screen which contains the **Settings** button, camera status blocks and **Notification Area**.

Status Indicator - Red or green toggle circle on virtual wall status block, which indicates whether that specific matte is in use.

T

TCP (Transmission Control Protocol) - A communication-oriented Internet protocol which transmits data packets, providing guaranteed data delivery.

Tilt - A vertical pan where the camera pivots up or down from a fixed point.

Tracking - Data transmitted to operator concerning the camera's moves and locations.

Track Settings Configuration File - File containing the track setting configurations.

U

UDP (User Datagram Protocol) - A connectionless Internet protocol which transmits data packets without guaranteeing error free data delivery.

UI - User interface.

V

Value-Change Control - Control that allow users to change the increment by which value fields are adjusted when using **Position Control Block** arrows or **Up/Down** arrows.

Virtual Camera - Computer generated camera used to record virtual elements.

Virtual Set - Set consisting of foreground and background graphics. Requires a green or blue screen.

Visibility Indicator - Eye icon on a virtual wall status box. Indicates to the operator if matte is transparent or visible.

X

X-Axis - Virtual axis running parallel to rails.

Y

Y-Axis - Virtual axis between the rails and the camera head.

Z

Z-Axis - Virtual axis running perpendicular to the rails and bisecting the virtual set.

Zero Offsets - Resets **Distance Offset** to zero.

Zoom - Making the subject appear closer or farther away by changing the FOV of the lens.

Appendix A: Supported Lenses, Mounts and Protocols

The following lenses, mounts and tracking protocols are supported by Lucid Studio 7.3.

[Compatible Lenses](#)

[Compatible Camera Mounts](#)

[Compatible Tracking Protocols](#)

Lucid Studio 7.3 Compatible Lenses

- 7.3Canon CJ12ex4.3B IASE S 2/3
- Canon CJ12ex4.3B IASE S Ursa Mini
- Canon CJ14ex4.3B IASE S
- Canon CJ14ex4.3B IASE S - voyager spherical
- Canon CN7x17 KAS S/P1 - Amira 4K
- Canon HJ11ex4.7B IASE
- Canon HJ11ex4.7B IASE-TWC
- Canon HJ11ex4.7B IASE - URSA
- Canon HJ14ex4.3B IASE
- Canon HJ14ex4.3B IASE (HH14.010/01619973)
- Canon HJ14ex4.3B IASE United#01619972
- Canon HJ17ex6.2B IASE
- Canon HJ17ex7.6B IASE
- Canon HJ17ex7.7B IASE
- Canon HJ18ex7.6B IASE S
- Canon HJ21ex7.5B IASE A
- Canon HJ22ex7.6B IASE
- Canon HJ22ex7.6B IASE (Finepoint 00045247/01219060)
- Canon HJ22ex7.6B IASE (v2-Finepoint 00045247/01219060)
- Canon HJ22ex7.6B IASE Football
- Canon KJ10EX4.5B IASE A
- Canon KJ17ex7.7B IASE
- Canon XJ17ex7.7B IASE
- Canon XJ22x7.3B IE
- Canon XJ23x7B IE
- Canon XJ25x6.8B IE
- Canon XJ60x9B IE DigiSuper 60
- Fuji DigiPower 22
- Fuji DigiPower 77
- Fuji HA14x4.5BERD-S6B
- Fuju HA14x4.5
- Fuji HA14x4.5BERD-S6B - URSA Broadcast
- Fuji HA14x4.5BEZD-T5DB
- Fuji HA18x5.5BERD-S6
- Fuji HA18x5.5BERD-S6 - SN7301593

- Fuji HA18x7.6BERD-S6B
- Fuji HA18x7.6BEZD-T4DD
- Fuji HA19x7.4BERD-S6
- Fuji HA23x7.6BERD-S6
- Fuji HA23x7.6BERD-S6 - URSA Broadcast
- Fuji HAS18x7.6BZD-T5DD
- Fuji UA13x4.5BERD-S9
- Fuji UA14x4.5BERD-S6B -SN7610353
- Fuji UA18x5.5BERD-S6
- Fuji UA22x8BERD-S8
- Fuji UA24x7.8BERD-S10B - SN7651143
- Fuji UA24x7.8BERD-S10B - SN7651182
- Fuji XK6x20-SAF -F-55-Voyager - #7040749 - V3
- Fuji XK6x20-SAF - SonyF-55
- Fuji ZA12x4.5BERD-S6
- Fuji ZA 12x4.5BERD-S6 - SN450526
- Fuji ZA17x7.6BERD-S6
- Fuji ZA17x7.6BERD-S6 - SN6505505
- Fuji ZA17x7.6BRD-S6
- Fuji ZA22x7.6BERD-S6
- Fuji ZA22x7.6BERD-S6 - SN20130201
- Fuji ZK12x25-F -F-55 - Voyager -#703023 -v3
- Fuji ZK35x85-SAFB - F-55 - Voyager - #7015642 -V3
- Fuji ZK4.7x19-SAF - Amira 4K
- Mobile Tracked Camera
- Panasonic AW-UE150KEJ
- Panasonic AW-UE150KEJ - #6
- Setup-NoNodeShift
- Sony BRC-1000
- Sony BRC-X400

Lucid Studio 7.3 Compatible Camera Mounts

- BlackTrax
- Cambotics Ped
- Egriment
- Furio Curved
- Furio Straight
- Jib CamMate
- Jib e-Crane
- Jib Jimmy Jib
- Motion Analysis
- NCAM
- SkyCam
- SolidTrack
- Spidercam
- StarTracker
- Stype
- Talon
- Tripod
- Vinten 250E
- Vinten 430i
- Vinten 750i
- Vinten FHR-35
- Vinten Fusion
- Vinten Quatro SE
- X350

Lucid Studio 7.3 Compatible Tracking Protocols

- None (used for local control when no tracking data is available)
- BlackTrax
- FreeD
- Kuper
- LucidTrack
- MoSys
- Motion Analysis
- NCAM
- NCAMLite
- Orad
- Radamec
- SMT
- SolidTrack
- Spidercam
- Stype
- Telemetrics
- Trackmen

Appendix B: Testing SLP

If SLP is enabled in the Lucid setup (see [Auto-Discovery \(SLP\)](#)) and port 427 is also enabled, but services on your network aren't being discovered, you can test it using the following procedure.

To test SLP:

1. In the Windows **Search** field, start typing "command prompt".
2. In the results, select the **Command Prompt** application.

The **Command Prompt** window opens.

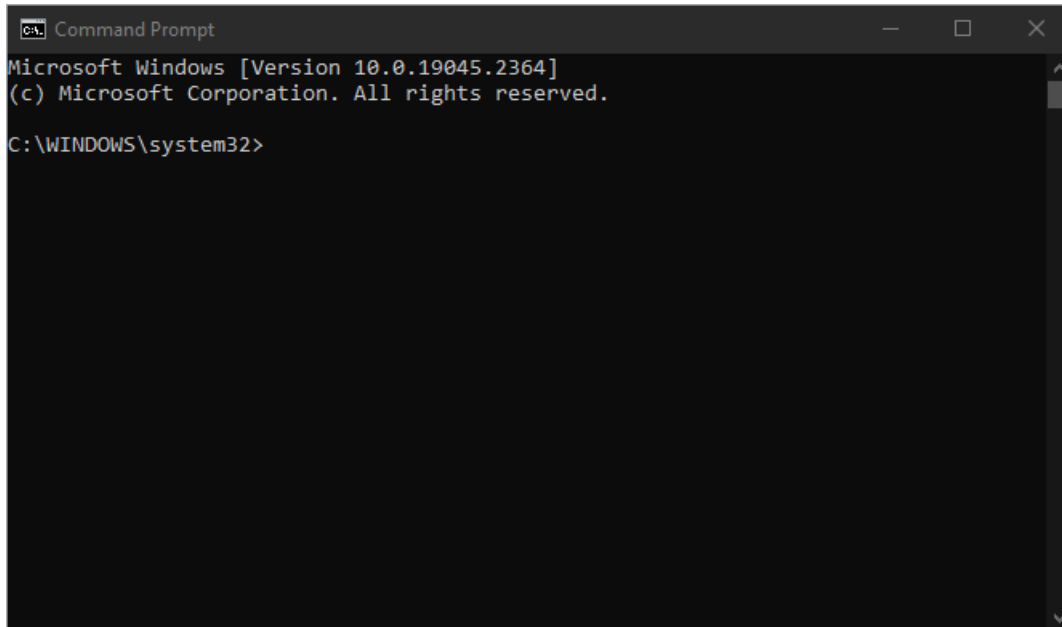

```
CA: Command Prompt
Microsoft Windows [Version 10.0.19045.2364]
(c) Microsoft Corporation. All rights reserved.

C:\WINDOWS\system32>
```

SLP - Command Prompt Window

3. Type "cd c:\program files\openslp".
4. Then type "slptool findsrvs service:track.lucid.rossvideoservice:track.lucid.rossvideo://9.68.86.9:86,6555.
A list of connected services is returned.
5. If you don't get any results, contact [Technical Support](#) for assistance.



Contact Us

Contact our friendly and professional support representatives for the following:

- Name and address of your local dealer
- Product information and pricing
- Technical support
- Upcoming trade show information

Technical Support	Telephone:	+1-844-652-0645 (North America)
		+800 3540 3545 (International)
	After Hours Emergency:	+1 613 • 349 • 0006
	Email:	techsupport@rossvideo.com

General Information	Telephone:	+1 613 • 652 • 4886
	Fax:	+1 613 • 652 • 4425
	Email:	solutions@rossvideo.com
	Website:	http://www.rossvideo.com

Visit Us

Visit our website for:

- Company information and news
- Related products and full product lines
- Online catalog
- Testimonials