

# PIERO

## User Guide

VERSION 20.2

**ROSS**



# Thank You for Choosing Ross

You've made a great choice. We expect you will be very happy with your purchase of Ross Technology.

Our mission is to:

1. Provide a Superior Customer Experience
  - offer the best product quality and support
2. Make Cool Practical Technology
  - develop great products that customers love

Ross has become well known for the Ross Video Code of Ethics. It guides our interactions and empowers our employees. I hope you enjoy reading it below.

If anything at all with your Ross experience does not live up to your expectations be sure to reach out to us at [solutions@rossvideo.com](mailto:solutions@rossvideo.com).



David Ross

CEO, Ross Video

[dross@rossvideo.com](mailto:dross@rossvideo.com)

## Ross Video Code of Ethics

Any company is the sum total of the people that make things happen. At Ross, our employees are a special group. Our employees truly care about doing a great job and delivering a high quality customer experience every day. This code of ethics hangs on the wall of all Ross Video locations to guide our behavior:

1. We will always act in our customers' best interest.
2. We will do our best to understand our customers' requirements.
3. We will not ship crap.
4. We will be great to work with.
5. We will do something extra for our customers, as an apology, when something big goes wrong and it's our fault.
6. We will keep our promises.
7. We will treat the competition with respect.
8. We will cooperate with and help other friendly companies.
9. We will go above and beyond in times of crisis. *If there's no one to authorize the required action in times of company or customer crisis - do what you know in your heart is right. (You may rent helicopters if necessary.)*

# PIERO User Guide

- Ross Part Number: 3400DR-001-20.2
- Version: 20.2

The information contained in this guide is subject to change without notice or obligation.

## Copyright

©2025 Ross Video Limited, Ross®, and any related marks are trademarks or registered trademarks of Ross Video Limited. All other trademarks are the property of their respective companies. PATENTS ISSUED and PENDING. All rights reserved. No part of this publication may be reproduced, stored in a retrieval system, or transmitted in any form or by any means, mechanical, photocopying, recording or otherwise, without the prior written permission of Ross Video. While every precaution has been taken in the preparation of this document, Ross Video assumes no responsibility for errors or omissions. Neither is any liability assumed for damages resulting from the use of the information contained herein.

## Patents

Patent numbers US 7,034,886; US 7,508,455; US 7,602,446; US 7,802,802 B2; US 7,834,886; US 7,914,332; US 8,307,284; US 8,407,374 B2; US 8,499,019 B2; US 8,519,949 B2; US 8,743,292 B2; GB 2,419,119 B; GB 2,447,380 B; and other patents pending.

## Notice

The material in this manual is furnished for informational use only. It is subject to change without notice and should not be construed as commitment by Ross Video Limited. Ross Video Limited assumes no responsibility or liability for errors or inaccuracies that may appear in this manual.

# End User Software License Agreement

This End User Software License Agreement is a legal agreement between you (the "Licensee") and Ross Video Limited ("Ross Video") specifying the terms and conditions of your installation and use of the Software and all Documentation (as those terms are defined herein).

## IMPORTANT:

**BY DOWNLOADING, ACCESSING, INSTALLING OR USING THE SOFTWARE AND/OR DOCUMENTATION AND/OR BY AUTHORIZING ANY THIRD PARTY, INCLUDING WITHOUT LIMITATION AN INSTALLER OR COMMISSIONER ACTING ON YOUR BEHALF TO DO SO, LICENSEE AGREES TO THE TERMS OF THIS AGREEMENT AND THE LICENSE GRANTED HEREUNDER SHALL BE EFFECTIVE AS OF AND FROM SUCH DATE. IF YOU DO NOT WISH TO ACCEPT THE TERMS AND CONDITIONS OF THIS AGREEMENT, DO NOT DOWNLOAD, ACCESS, INSTALL, REFER TO OR OTHERWISE USE THE SOFTWARE AND/OR DOCUMENTATION.**

1. **INTERPRETATION.** In this Agreement, (a) words signifying the singular number include the plural and vice versa, and words signifying gender include all genders; (b) every use of the words "herein", "hereof", "hereto" "hereunder" and similar words shall be construed to refer to this Agreement in its entirety and not to any particular provision hereof; (c) reference to any agreement or other document herein will be construed as referring to such agreement or other document as from time to time amended, modified or supplemented (subject to any restrictions on such amendment, modification or supplement set forth therein); (d) every use of the words "including" or "includes" is to be construed as meaning "including, without limitation" or "includes, without limitation", respectively; and (e) references to an Article or a Section are to be construed as references to an Article or Section of or to this Agreement unless otherwise specified.
2. **DEFINITIONS.** In this Agreement, in addition to the terms defined elsewhere in this Agreement, the following terms have the meanings set out below:

"**Affiliate**" means, with respect to any Person, any other Person who directly or indirectly controls, is controlled by, or is under direct or indirect common control with, such Person. A Person shall be deemed to control a Person if such Person possesses, directly or indirectly, the power to direct or cause the direction of the management and policies of such Person, whether through the ownership of voting securities, by contract or otherwise; and the term "controlled" and "controlling" shall have a similar meaning.

"**Agreement**" means this End User Software License Agreement including the recitals hereto, as the same may be amended from time to time in accordance with the provisions hereof.

"**Backup System**" means the secondary piece of Designated Equipment upon which the Software is installed and mirrored for the sole purpose of replacing a Primary System in the event such Primary System is not available or functioning properly for any reason.

"**Change of Control**" means (a) the direct or indirect sale, transfer or exchange by the shareholders of a Party of more than fifty percent (50%) of the voting securities of such Party, (b) a merger or amalgamation or reorganization or other transaction to which a Party is party after which the shareholders of such Party immediately prior to such transaction hold less than fifty percent (50%) of the voting securities of the surviving entity, (c) the sale, exchange, or transfer of all or substantially all of the assets of a Party.

**"Confidential Information"** means all data and information relating to the business and management of either Party, including the Software, trade secrets and other technology to which access is obtained or granted hereunder by the other Party, and any materials provided by Ross Video to Licensee; provided, however, that Confidential Information shall not include any data or information which:

- (i) is or becomes publicly available through no fault of the other Party;
- (ii) is already in the rightful possession of the other Party prior to its receipt from the other Party;
- (iii) is already known to the receiving Party at the time of its disclosure to the receiving Party by the disclosing Party and is not the subject of an obligation of confidence of any kind;
- (iv) is independently developed by the other Party;
- (v) is rightfully obtained by the other Party from a third party; or
- (vi) is disclosed with the written consent of the Party whose information it is.

**"Designated Equipment"** shall mean (a) the hardware products sold by Ross Video to Licensee on which the Software is installed and licensed for use, as the same may be replaced from time to time by Ross Video; or (b) in the case of Software licensed on a stand-alone basis, the equipment of Licensee on which the Software is to be installed and meets the minimum specifications set out in the Documentation.

**"Documentation"** shall mean manuals, instruction guides, user documentation and other related materials of any kind pertaining to the Software (whether in electronic, hard-copy or other media format) that are furnished to Licensee by or on behalf of Ross Video in relation to the Software.

**"Freeware"** means Software that is available free of charge from Ross Video, and includes, without limitation the master control system software known as "DashBoard".

**"Governmental Authority"** means (a) any federal, provincial, state, local, municipal, regional, territorial, aboriginal, or other government, governmental or public department, branch, ministry, or court, domestic or foreign, including any district, agency, commission, board, arbitration panel or authority and any subdivision of any of them exercising or entitled to exercise any administrative, executive, judicial, ministerial, prerogative, legislative, regulatory, or taxing authority or power of any nature; and (b) any quasi-governmental or private body exercising any regulatory, expropriation or taxing authority under or for the account of any of them, and any subdivision of any of them.

**"Improvements"** means all inventions, works, discoveries, improvements and innovations of or in connection with the Software, including error corrections, bug fixes, patches and other updates in Object Code form to the extent made available to Licensee in accordance with Ross Video's release schedule.

**"License Fee"** means the fee(s), if any, payable in respect of the Software in accordance with the relevant invoice(s) or other purchase documents delivered in connection with this Agreement.

**"License Period"** means the period of time that Licensee will have the rights granted under this Agreement, as may be specified in an Order.

**"Modifications"** means any enhancements, changes, corrections, translations, adaptations, revisions, developments, upgrades or updates thereto; and "Modify" shall mean the creation of any of the foregoing.

**"Object Code"** means the machine readable executable form of a computer software program.

**"Open Source Components"** means third party Open Source software, libraries or other components.

**"Open Source License"** means the license that governs each Open Source Component.

**"Order"** means the documents provided by Ross Video to Licensee detailing the Ross Video products contemplated for purchase, the corresponding fees and License Period that may apply to the Software, including any and all quotations, purchase orders, acknowledgments, pro formas, invoices and other purchase documentation.

**"Parties"** means both Ross Video and Licensee and "Party" means either one of them as the context requires.

**"Person"** will be broadly interpreted and includes (a) a natural person, whether acting in his or her own capacity, or in his or her capacity as executor, administrator, estate trustee, trustee or personal or legal representative; (b) a corporation or a company of any kind, a partnership of any kind, a sole proprietorship, a trust, a joint venture, an association, an unincorporated association, an unincorporated syndicate, an unincorporated organization or any other association, organization or entity of any kind; and (c) a Governmental Authority.

**"Primary System"** means the Designated Equipment upon which the Software is installed and executed to deliver its intended functionality.

**"Released Claims"** has the meaning ascribed to it in Section 9(b).

**"Released Parties"** has the meaning ascribed to it in Section 9(b).

**"Ross Video"** means Ross Video Limited and its Affiliates.

**"Software"** means the version of the Object Code licensed and delivered to Licensee by Ross Video concurrently with delivery of this Agreement, including without limitation the Freeware, and any subsequent error corrections, updates, Modifications or Improvements provided to Licensee by Ross Video pursuant to this Agreement, but specifically excluding any features or plug-ins that may be purchased by you directly from third parties as upgrades or enhancements to the Software.

**"Source Code"** means the human readable form of a computer software program, and all tools and documentation necessary for a reasonably competent computer programmer to understand, maintain and Modify the Software.

**"Third Party Software"** means those portions of the Software, if any, which are owned or controlled by third parties and licensed to Ross Video pursuant to certain license agreements or arrangements with such third parties, including the Open Source Components and NDI®<sup>1</sup> software (<http://NDI.video>); and

**"Use"** means to execute, run, display, store, merge, network, Modify, translate, host or integrate with Licensee's products or other third party software.

<sup>1</sup> NDI® is a registered trademark of Vizrt NDI AB.

3. **LICENSE.** Subject to the terms and conditions of this Agreement, upon payment of the applicable License Fee by Licensee, or, in the case of Freeware only, upon download of the Software by Licensee onto its Designated Equipment, Ross Video hereby grants to Licensee a non-transferable and non-exclusive right to Use the Software and Documentation solely for the internal use of Licensee (the "License"), during the License Period. In the event that a License Period is not identified on the Order, such License Period shall be deemed to be perpetual, subject to paragraph 10(c) of this Agreement. The Software shall only be used in connection with or installed on the Designated Equipment and, where applicable, shall only be used on the Primary System, provided such Primary System is operating properly."

If the Primary System is not operating properly for any reason, the Software may be used on the designated Backup System for that Primary System until such time that the Primary System begins operating properly. The Software and Documentation are provided to Licensee for the exclusive use by Licensee's organization for its ordinary business purposes and shall not be used by any third party for any purposes. Licensee may make copies of the Software as required for internal backup and archival purposes. To the extent permitted hereunder, Licensee may distribute copies of the Software and/or Documentation to members of its organization, provided (a) this Agreement is included with each copy, (b) any member of its organization who uses the Software and/or Documentation accepts and agrees to be bound by the terms of this Agreement and by any other license agreements or other agreement incorporated by reference into this Agreement, and (c) Licensee has paid any applicable additional License Fees in respect of copying and redistributing of the Software. To the extent Licensee is permitted to make copies of the Software under this Agreement, Licensee agrees to reproduce and include on any copy made or portion merged into another work, all Ross Video proprietary notices, including any notices with respect to copyrights, trademarks and this License. With the exception of copying the Software for backup or archival purposes, Licensee agrees to keep a record of the number and location of all such copies and will make such record available at Ross Video's request. The Software may include mechanisms to limit or inhibit copying.

4. **LICENSE RESTRICTIONS.** Except as otherwise provided in section 3 above, Licensee shall not: (1) copy any Software or Documentation, or part thereof, which is provided to Licensee by Ross Video pursuant to this Agreement, in Object Code form, Source Code form or other human or machine readable form, including written or printed documents, without the prior written consent of Ross Video; (2) in any way market, distribute, export, translate, transmit, merge, Modify, transfer, adapt, loan, rent, lease, assign, share, sub-license, sell, make available for download on any website or make available to another Person, the Software and/or Documentation, in whole or in part, provided that Licensee shall not be prohibited from renting or leasing the Software if Ross Video has consented, in writing, to Licensee engaging in such activities in respect of the Software; (3) reverse engineer, decompile or disassemble the Software or electronically transfer it into another computer language; or (4) use the Software or Documentation in a manner that is inconsistent with the License granted hereunder or that will result in a breach of this Agreement. Licensee agrees to take all reasonable precautions to prevent third parties from using the Software and/or Documentation in any way that would constitute a breach of this Agreement, including such precautions Licensee would ordinarily take to protect its own proprietary software, hardware or information.
5. **DELIVERY.** Ross Video shall deliver to Licensee one (1) master copy of the Software in compiled binary (executable) form suitable for reproduction in electronic files only and Ross Video shall deliver to Licensee a minimum of one copy of the Documentation.
6. **IMPROVEMENTS.** Licensee may from time to time request Ross Video to incorporate certain Improvements into the Software. Ross Video may, in its sole discretion, undertake to incorporate and provide such Improvements to Licensee with or without payment of a fee to be negotiated at the time of such request. All Improvements, whether recommended and developed by Ross Video or Licensee, shall be considered the sole property of Ross Video and shall be used by Licensee pursuant to the terms of the License granted under this Agreement.

7. **FREWARE.** Other than the obligation to pay a License Fee, which does not apply to the Freeware, all other provisions of this End User Software License Agreement apply to the Freeware in the same way as they apply to all other Software that is the subject of this Agreement. In addition, in connection with the Freeware, the following provisions apply:
  - a. Licensee will not Use the Freeware to engage in or allow others to engage in any illegal activity.
  - b. Licensee will not Use the Freeware in any way that will interfere with or damage the operation of the services of any third parties by overburdening/disabling network resources through automated queries, excessive usage or similar conduct.
  - c. Licensee will not Use the Freeware to engage in any activity that will violate the rights of others, including, without limitation, by using it for operations that involve child labour, suppressing the right of freedom of expression or endangering the security of person.
8. **OWNERSHIP.** The Parties acknowledge and agree that, as between the Parties, Ross Video shall be the owner of all intellectual property rights in the Software, Documentation and all related Modifications and Improvements, written materials, logos, trademarks, trade names, copyright, patents, trade secrets and moral rights, registered or unregistered. No proprietary interest or title in or to the intellectual property in the Software, Documentation or any Improvements or Modifications is transferred to Licensee by this Agreement. Ross Video reserves all rights not expressly licensed to Licensee under section 3.
9. **OPEN SOURCE SOFTWARE.**
  - a. Software may use and/or be provided with Open Source Components, including those detailed in the Third Party section below. To the extent stipulated by its Open Source License, each such Open Source Component is licensed directly to Licensee from its respective licensors and not sub-licensed to Licensee by Ross Video, and such Open Source Component is subject to its respective Open Source License, and not to this Agreement. If, and to the extent, an Open Source Component requires that this Agreement effectively impose, or incorporate by reference, certain disclaimers, permissions, provisions, prohibitions or restrictions, then such disclaimers, permissions, provisions, prohibitions or restrictions shall be deemed to be imposed, or incorporated by reference into this Agreement, as required, and shall supersede any conflicting provision of this Agreement, solely with respect to the corresponding Open Source Component which is governed by such Open Source License.
  - b. If Licensee, or another party on Licensee's behalf, modifies, replaces or substitutes any Open Source Component used in or provided with this Software, Licensee hereby fully, forever, irrevocably and unconditionally releases and discharges Ross Video, its Affiliates and its and their employees, officers, directors, resellers, distributors and representatives (collectively, "Released Parties") from any and all claims, charges, complaints, demands, actions, causes of action, suits, rights, debts, covenants, liabilities, warranties, performance and maintenance and support obligations (collectively, "Released Claims"), of every kind and nature, with respect to such Software, including without limitation any such Released Claims that arise as a matter of applicable Law.
  - c. If an Open Source License requires that the source code of its corresponding Open Source Component be made available to Licensee, and such source code was not delivered to Licensee with the Software, then Ross Video hereby extends a written offer, valid for the period prescribed in such Open Source License, to obtain a copy of the source code of the corresponding Open Source Component, from Ross Video from <https://www.rossvideo.com/open-source-information/>.

## 10. THIRD PARTY SOFTWARE.

- a. Licensee acknowledges that the Third Party Software is not owned by Ross Video. Notwithstanding any other provision of this Agreement, Ross Video, to the extent permitted by applicable law, offers no warranties (whether express, implied, statutory or by course of communication or dealing with Licensee, or otherwise) with respect to the Third Party Software. Ross Video may pass through to Licensee, if and to the extent permitted by applicable law, any warranties expressly provided by such third parties to Ross Video for such Third Party Software.
- b. FFmpeg Notice. The Software may utilize FFmpeg video components and their included libraries. FFmpeg is a trademark of Fabrice Bellard (originator of the FFmpeg project). Ross Video disclaims any ownership claim to FFmpeg. Please refer to <http://ffmpeg.org> (copyright is in the FFmpeg developers). FFmpeg is licensed under the GNU Lesser General Public License v2.1 or Lesser General Public License v3.0. GNU Lesser General Public License contact information: Free Software Foundation, Inc., 51 Franklin Street, Fifth Floor, Boston, MA 02110-1301 USA. Licensee can distribute it and/or modify it under the terms of such licenses."

## 11. INTELLECTUAL PROPERTY INDEMNITY.

- a. Ross Video agrees to defend, indemnify and hold harmless Licensee from final damages awarded by a court of competent jurisdiction (hereinafter referred to as the "**Losses**"), which Licensee, or any of its officers or directors, may incur, suffer or become liable for as a result of, or in connection with, any third party claim asserted against Licensee to the extent such claim is based on a contention that the Software, Documentation or any portion thereof, infringes any valid, registered, enforceable patents, copyrights, trade secrets, trademarks or other intellectual property rights of any third party, provided that (a) the allegedly infringing Software or Documentation has been used within the scope of and in accordance with the terms of this Agreement, and (b) Licensee notifies Ross Video in writing of such claim within ten (10) days of a responsible officer of Licensee becoming aware of such claim. If the Software, Documentation or any portion thereof is held to constitute an infringement of a third party's intellectual property rights, and use thereof is enjoined, Ross Video shall, at its election and expense, either (i) procure the right to use the infringing element of the Software or Documentation; or (ii) replace or modify the element of the Software or Documentation so that the infringing portion is no longer infringing and still performs the same function without any material loss of functionality. Ross Video shall make every reasonable effort to correct the situation with minimal effect upon the operations of Licensee.
- b. Notwithstanding the above, Ross Video reserves the right to terminate this Agreement and the License granted hereunder on immediate notice to Licensee, and without liability to Licensee, in the event that the Software or Documentation constitutes or may, in Ross Video's determination, constitute, an infringement of the rights of a third party that Ross Video, in its sole discretion, does not consider to be affordably remediable.
- c. Either party may terminate this Agreement immediately should any Software become, or in either party's opinion be likely to become, the subject of a claim of infringement of any intellectual property right and, in such event, there shall be no claim by either Licensee or Ross Video against the other arising out of such termination, provided that the foregoing shall not apply to a claim for infringement by Ross Video against Licensee in the event that Licensee is alleged to have infringed Ross Video's intellectual property rights, in which case Licensee shall remain liable for all outstanding License Fees and other amounts owing to Ross Video.
- d. Notwithstanding the foregoing, Ross Video shall have no liability for any claim of infringement based on use of other than a current, unaltered release of the Software and/or Documentation available from Ross Video if such infringement would have been avoided by the use of a current, unaltered release of the Software and/or Documentation provided that such current, unaltered release performs substantially in conformity with the specifications set out in the Documentation and was provided, at no additional cost by Ross Video, to those subscribing for maintenance services for the Software or Documentation.

12. **CONFIDENTIALITY.** Each Party shall maintain in confidence all Confidential Information of the other Party, shall use such Confidential Information only for the purpose of exercising its rights and fulfilling its obligations under this Agreement, and shall not disclose any Confidential Information of the disclosing Party to any third party except as expressly permitted hereunder or make any unauthorized use thereof. Each Party shall disclose the Confidential Information only to those of its employees, consultants, advisors, and/or subcontractors who have a need to know the Confidential Information. Each Party shall, prior to disclosing the Confidential Information to such employees, consultants, advisors and/or subcontractors, obtain their agreement to receive and use the Confidential Information on a confidential basis on the same terms and conditions contained in this Agreement. The receiving Party shall treat the Confidential Information of the disclosing Party with the same degree of care against disclosure and/or unauthorized use as it affords to its own information of a similar nature, or a reasonable degree of care, whichever is greater. The receiving Party further agrees not to remove or destroy any proprietary or confidential legends or markings placed upon any documents or other materials of the disclosing Party. The obligations of confidence set forth in this Agreement shall extend to any Affiliates that have received Confidential Information of the disclosing Party and shall also cover Confidential Information disclosed by any Affiliate. The receiving Party shall be responsible for any actions or omissions of its Affiliates as if such actions or omissions were its own.

Either party may disclose certain Confidential Information if it is expressly required to do so pursuant to legal, judicial, or administrative proceedings, or otherwise required by law, provided that (i) such Party provides the other Party with reasonable written notice prior to such disclosure; (ii) such Party seeks confidential treatment for such Confidential Information; (iii) the extent of such disclosure is only to the extent expressly required by law or under the applicable court order; and (iv) such Party complies with any applicable protective or equivalent order.

Each of Ross Video and Licensee (the "**Indemnifying Party**", as applicable) agree to indemnify the other (the "**Indemnified Party**", as applicable) for all Losses incurred by the Indemnified Party as a result of a failure of the Indemnifying Party to comply with its obligations under this Section 12 provided that the Indemnified Party has given prompt notice of any such claim and, to the extent that a claim may lie against a third party for the unauthorized disclosure of such Confidential Information, the right to control and direct the investigation, preparation, action and settlement of each such claim and, further, provided that the Indemnified Party reasonably co-operates with the Indemnifying Party in connection with the foregoing and provides the Indemnifying Party with all information in the Indemnified Party's possession related to such claim and such further assistance as reasonably requested by the Indemnifying Party.

The Parties acknowledge and agree that any breach of the confidentiality provisions of this Agreement by one Party may cause significant and irreparable injury to the other Party that is not compensable monetarily, as well as damages that may be difficult to ascertain, and agrees that, in addition to such other remedies that may be available at law or in equity, the other Party shall be entitled to seek injunctive relief (including temporary restraining orders, interim injunctions and permanent injunctions) in a court of competent jurisdiction in the event of the breach or threatened breach by such party of any of the confidentiality provisions of this Agreement. The relief contemplated in this Section shall be available to each Party without the necessity of having to prove actual damages and without the necessity of having to post any bond or other security. Each Party further agrees to notify the other Party in the event that it learns of or has reason to believe that any Person has breached the confidentiality provisions of this Agreement.

13. **LIMITATION OF LIABILITY.** The limitation of liability provisions of this Agreement reflect an informed voluntary allocation of the risks (known and unknown) that may exist in connection with the licensing of the Software or Documentation hereunder by Ross Video, and that voluntary risk allocation represents a material part of the Agreement reached between Ross Video and Licensee. Should Ross Video be in breach of any obligation, Licensee agrees that Licensee's remedies will be limited to those set forth in this Agreement. No action, regardless of form, arising out of this Agreement may be brought by Licensee more than twelve (12) months after the facts giving rise to the cause of action have occurred, regardless of whether those facts by that time are known to, or reasonably ought to have been discovered by, Licensee.

(A) EXCEPT AS EXPRESSLY PROVIDED IN THIS AGREEMENT, THE SOFTWARE AND DOCUMENTATION ARE PROVIDED "AS IS" AND ROSS VIDEO (I) MAKES NO OTHER REPRESENTATIONS, AND PROVIDES NO WARRANTIES OR CONDITIONS OF ANY KIND, EXPRESS OR IMPLIED, STATUTORY, BY USAGE OF TRADE CUSTOM OF DEALING, OR OTHERWISE, AND (II) SPECIFICALLY DISCLAIMS ALL IMPLIED WARRANTIES INCLUDING ANY IMPLIED WARRANTY OF UNINTERRUPTED OR ERROR FREE OPERATION, MERCHANTABILITY, QUALITY OR FITNESS FOR A PARTICULAR PURPOSE. ROSS VIDEO DOES NOT REPRESENT OR WARRANT THAT THE SOFTWARE WILL MEET ANY OR ALL OF LICENSEE'S PARTICULAR REQUIREMENTS, THAT THE USE AND OPERATION OF THE SOFTWARE WILL OPERATE ERROR-FREE OR UNINTERRUPTED, THAT ALL PROGRAMMING ERRORS IN THE SOFTWARE CAN BE FOUND IN ORDER TO BE CORRECTED, OR THAT THE SOFTWARE WILL BE COMPATIBLE WITH OTHER PROGRAMS, SYSTEMS, AND HARDWARE.

(B) IN NO EVENT SHALL ROSS VIDEO, ITS AFFILIATES AND LICENSORS, AND THEIR RESPECTIVE DIRECTORS, OFFICERS, EMPLOYEES AND AGENTS, BE LIABLE FOR ANY CLAIM FOR INDIRECT, CONSEQUENTIAL, SPECIAL, INCIDENTAL, PUNITIVE, EXEMPLARY, AGGRAVATED DAMAGES; LOST PROFITS, OR LOST REVENUE ARISING FROM OR IN CONNECTION WITH THIS AGREEMENT, REGARDLESS OF THE FORM OF ACTION, WHETHER IN CONTRACT, OR IN TORT, EVEN IF THE PARTY HAS BEEN ADVISED OF THE POSSIBILITY OF SUCH DAMAGES.

(C) IN ANY EVENT THE AGGREGATE LIABILITY OF ROSS VIDEO, ITS AFFILIATES AND LICENSORS, AND THEIR RESPECTIVE DIRECTORS, OFFICERS, EMPLOYEES AND AGENTS, FOR ANY CLAIM FOR DIRECT DAMAGES WITH RESPECT TO THE SUBJECT MATTER OF THIS AGREEMENT SHALL NOT EXCEED THE AMOUNT OF THE PURCHASE PRICE PAID TO ROSS VIDEO UNDER THIS AGREEMENT.

14. **TERM AND TERMINATION.**

- (1) Unless terminated earlier in accordance with the terms of this Agreement, the term of this Agreement shall commence upon Licensee's first download, access, installation, or other use of the Software or Documentation and continues until, in the case of Software licensed with Designated Equipment provided by Ross Video, the earliest of (a) the end of the License Period, or (b) if the Designated Equipment is assigned or transferred in accordance with this Agreement, the date on which the Designated Equipment is no longer owned by Licensee;
- (2) Either Party shall have the right to terminate this Agreement on notice to the other Party if:
  - (a) the other Party fails to pay any fees or other amounts when due hereunder or under any other agreement between the Parties (or any Affiliates of the Parties, as applicable) in connection with the Software and/or Designated Equipment and such breach is not cured within thirty (30) days after written notice of such failure to pay is given to the defaulting Party by the non-defaulting Party;
  - (b) the other Party shall file a voluntary petition in bankruptcy or insolvency or shall petition for reorganization under any bankruptcy law, consent to an involuntary petition in bankruptcy, or if a receiving order is given against it under the Bankruptcy and Insolvency Act (Canada) or the comparable law of any other jurisdiction (and such is not dismissed within ten (10) days);

- (c) there shall be entered an order, judgment or decree by a court of competent jurisdiction, upon the application of a creditor, approving a petition seeking reorganization or appointing a receiver, trustee or liquidator of all or a substantial part of the other Party's assets and such order, judgment or decree continues in effect for a period of thirty (30) consecutive days; or
- (d) the other Party shall fail to perform any of the other material obligations set forth in this Agreement and such default, in the case of a default which is remediable, continues for a period of thirty (30) days after written notice of such failure has been given by the non-defaulting Party or, in the case of a non-remediable default, immediately upon notice.

(3) Notwithstanding anything to the contrary contained in this Agreement:

- (a) Ross Video may forthwith terminate this Agreement if Licensee is in breach of any of sections 3, 4 or 12 of this Agreement. For greater certainty, in such instances Ross Video shall provide written notice of such termination as soon as practicable but written notice shall not be a necessary prerequisite to such termination; and
- (b) in the event of a Change of Control of Licensee, Ross Video shall have the right to terminate this Agreement and the License granted hereunder upon thirty (30) days' prior written notice to Licensee. For greater certainty, Ross Video's right to terminate in the event of a Change of Control of Licensee shall continue for a period of six (6) months from the date Licensee delivers notice of such Change of Control to Ross Video.
- (c) Ross Video may terminate the License immediately on the date on which it provides notice to Licensee, if its agreements for Third Party Software are terminated.

(4) Upon the termination or expiry of this Agreement:

- (a) Licensee shall immediately cease and desist all use of the Software and Documentation;
- (b) Licensee shall immediately deliver to Ross Video any of Ross Video's Confidential Information provided hereunder (including the Software and Documentation) then in its possession or control, if any, and shall deliver a certificate of an officer of Licensee certifying the completeness of same;
- (c) Licensee shall refrain from further use of such Confidential Information; and
- (d) Licensee shall forthwith pay all amounts owing to Ross Video or any of its Affiliates hereunder.

15. **SURVIVAL.** The provisions of sections 1, 2, 6, 8, 9, 10, 11, 12, 13, 14, 18, 22, 23, and 24 herein shall survive the expiry or termination of this Agreement.
16. **FORCE MAJEURE.** Dates and times by which Ross Video is required to render performance under this Agreement shall be automatically postponed to the extent and for the period that Ross Video is prevented from meeting them by reason of events of force majeure or any cause beyond its reasonable control provided Ross Video notifies Licensee of the commencement and nature of such cause and uses its reasonable efforts to render performance in a timely manner.
17. **ASSIGNMENT.** Ross Video may assign this Agreement, or any of its rights or obligations hereunder, in whole or in part, upon notice to Licensee. Licensee shall not assign this Agreement, or any of its rights or obligations hereunder, in whole or in part, without the prior written consent of Ross Video, which consent may not be unreasonably withheld. This Agreement enures to the benefit of and is binding upon each of the Parties and their respective successors and permitted assigns.

18. **GOVERNING LAW.** If Licensee acquired the Ross Product(s) in the United States or Canada, the laws of the state or province where Licensee's principal place of business is located govern the interpretation of this Agreement, claims for its breach, and all other claims regardless of conflict of laws principles. If Licensee acquired the Ross Product(s) in the European Union or the United Kingdom, then the laws of England and Wales apply. If Licensee acquired the Ross Product(s) in any other country, then the laws of the Province of Ontario, Canada shall apply.
19. **LANGUAGE.** The Parties have expressly required that this Agreement and all documents relating thereto be prepared in English. Les parties ont expressément exigé que cette convention ainsi que tous les documents qui s'y rattachent soient rédigés en anglais.
20. **GOVERNMENT CONTRACTS.** If the Software and/or Documentation to be furnished to Licensee hereunder are to be used in the performance of a government contract or subcontract, the Software and/or Documentation shall be provided on a "restricted rights" basis only and Licensee shall place a legend, in addition to applicable copyright notices, in the form provided under the applicable governmental regulations. For greater certainty, Ross Video shall not be subject to any flow-down provisions required by any customer of Licensee that is a Governmental Authority unless Ross Video expressly agrees to be bound by such flow-down provisions in writing.
21. **EXPORT AND IMPORT LAWS.** Licensee acknowledges and agrees that the Software (including any technical data and related technology) may be subject to the export control laws, rules, regulations, restrictions and national security controls of the United States and other applicable countries (the "**Export Controls**") and agrees not to export, re-export, import or allow the export, re-export or import of such export-controlled Software (including any technical data and related technology) or any copy, portion or direct product of the foregoing in violation of the Export Controls. Licensee hereby represents that it is not an entity or person to whom provision of the Software (including any technical data and related technology) is restricted or prohibited by the Export Controls. Licensee agrees that it has the sole responsibility to obtain any authorization to export, re-export, or import the Software (including any technical data and related technology), as may be required. Licensee will defend, indemnify and hold Ross Video harmless from any and all claims, losses, liabilities, damages, fines, penalties, costs and expenses (including attorney's fees) arising from or relating to any breach by Licensee of its obligations under this Section.
22. **AMENDMENT AND WAIVER.** No amendment, discharge, modification, restatement, supplement, termination or waiver of this Agreement or any Section of this Agreement is binding unless it is in writing and executed by the Party to be bound. No waiver of, failure to exercise or delay in exercising, any Section of this Agreement constitutes a waiver of any other Section (whether or not similar) nor does any waiver constitute a continuing waiver unless otherwise expressly provided.
23. **SEVERABILITY.** Each Section of this Agreement is distinct and severable. If any Section of this Agreement, in whole or in part, is or becomes illegal, invalid, void, voidable or unenforceable in any jurisdiction by any court of competent jurisdiction, the illegality, invalidity or unenforceability of that Section, in whole or in part, will not affect (a) the legality, validity or enforceability of the remaining Sections of this Agreement, in whole or in part; or (b) the legality, validity or enforceability of that Section, in whole or in part, in any other jurisdiction.
24. **ENTIRE AGREEMENT.** This Agreement, and any other documents referred to herein, constitutes the entire agreement between the Parties relating to the subject matter of this Agreement and supersedes all prior written or oral agreements, representations and other communications between the Parties.

*Updated: November 1, 2023*

# Warranty and Repair Policy

Ross Video Limited (Ross) warrants its PIERO systems to be free from defects under normal use and service for the following time periods from the date of shipment:

- PIERO Server — 12 months
- PIERO Software Upgrades — 12 months free of charge
- System and Media hard drives — 12 months

If an item becomes defective within the warranty period Ross will repair or replace the defective item, as determined solely by Ross.

Warranty repairs will be conducted at Ross, with all shipping FOB Ross dock. If repairs are conducted at the customer site, reasonable out-of-pocket charges will apply. At the discretion of Ross, and on a temporary loan basis, plug in circuit boards or other replacement parts may be supplied free of charge while defective items undergo repair. Return packing, shipping, and special handling costs are the responsibility of the customer.

This warranty is void if products are subjected to misuse, neglect, accident, improper installation or application, or unauthorized modification.

In no event shall Ross Video Limited be liable for direct, indirect, special, incidental, or consequential damages (including loss of profit). Implied warranties, including that of merchantability and fitness for a particular purpose, are expressly limited to the duration of this warranty.

This warranty is TRANSFERABLE to subsequent owners, subject to Ross' notification of change of ownership.

## Extended Warranty

For customers that require a longer warranty period, Ross offers an extended warranty plan to extend the standard warranty period by one year increments. For more information about an extended warranty for your PIERO system, contact your regional sales manager.

# Environmental Information

The equipment that you purchased required the extraction and use of natural resources for its production. It may contain hazardous substances that could impact health and the environment.

To avoid the potential release of those substances into the environment and to diminish the need for the extraction of natural resources, Ross Video encourages you to use the appropriate take-back systems. These systems will reuse or recycle most of the materials from your end-of-life equipment in an environmentally friendly and health conscious manner.

The crossed-out wheeled bin symbol invites you to use these systems.



If you need more information on the collection, reuse, and recycling systems, please contact your local or regional waste administration.

You can also contact Ross Video for more information on the environmental performances of our products.

# Company Address

## **Ross Video Limited**

8 John Street  
Iroquois, Ontario  
Canada, K0E 1K0

## **Ross Video Incorporated**

P.O. Box 880  
Ogdensburg, New York  
USA 13669-0880

---

**General Business Office:** (+1) 613 · 652 · 4886

**Fax:** (+1) 613 · 652 · 4425

**Toll Free Technical Support:** 1-844-652-0645 (North America)  
+800 3540 3545 (International)

**Alternately, you can contact:**

**Technical Support:** (+1) 613 · 652 · 4886

**After Hours Emergency:** (+1) 613 · 349 · 0006

**E-mail for Technical Support:** [techsupport@rossvideo.com](mailto:techsupport@rossvideo.com)

**E-mail for General Information:** [solutions@rossvideo.com](mailto:solutions@rossvideo.com)

**Website:** <http://www.rossvideo.com>

# Contents

<b>Introduction</b> .....	<b>1</b>
About This Guide .....	2
Getting Help .....	3
<b>What is PIERO?</b> .....	<b>4</b>
<b>Getting Started</b> .....	<b>5</b>
<b>Starting PIERO</b> .....	<b>6</b>
Starting PIERO for macOS .....	7
Starting PIERO for Linux (Ubuntu) .....	8
<b>Launching the PIERO Software</b> .....	<b>10</b>
Launching PIERO Broadcast Edition .....	11
Launching PIERO Club Edition .....	12
Changing PIERO Parameters .....	13
<b>PIERO User Interface Overview</b> .....	<b>14</b>
Broadcast Edition User Interface .....	15
Effects Panel .....	16
Timeline and Project Panel .....	22
Club Edition User Interface .....	27
<b>Creating a Project</b> .....	<b>28</b>
<b>Importing a Clip</b> .....	<b>29</b>
<b>Keying</b> .....	<b>32</b>
<b>Calibrating</b> .....	<b>34</b>
Calibration Tool User Interface Overview .....	35
General Setup .....	41
Setting up the Camera Position .....	42
Defining the Field/Court/Rink Model .....	44
Matching the Model to the Image .....	45
Line Tracker and Texture Tracker .....	54
Calibrating Lens Distortion .....	59
Cable Cam .....	61

KLT Cable Cam .....	62
Live Tracker .....	64
Telestrator .....	65
Recording a Calibration .....	66
<b>Adding Effects .....</b>	<b>68</b>
Presets .....	71
<b>Additional Tools .....</b>	<b>74</b>
Region Tool .....	75
Hide Tool .....	78
Clip Tool .....	79
Pause Control .....	80
XPression Control .....	82
<b>Previewing Final Output .....</b>	<b>85</b>
<b>Exporting to a Video File .....</b>	<b>86</b>
<b>PIERO Touch .....</b>	<b>88</b>
Touch User Interface Overview .....	90
<b>PIERO Remote iPad Application .....</b>	<b>94</b>
PIERO Remote iPad Application User Interface .....	97
<b>NDI® Input/Output .....</b>	<b>101</b>
<b>PIERO Plugin for Voyager .....</b>	<b>103</b>
Supported PIERO Effects .....	119
Supported PIERO Sports .....	123
<b>PIERO Effects .....</b>	<b>124</b>
Tips for Using PIERO Effects .....	126
3D Players .....	127
3D Player Data .....	130
3D Animated Player .....	132
3-Point Line .....	135
AR Players .....	136
Arc .....	138
Area .....	140
Arrow (Distance) .....	142

Arrow (Freehand) .....	144
Arrow (Height) .....	146
Arrow (Straight) .....	148
Caption Track .....	149
Circle .....	151
Counter .....	154
Crosshair Marker .....	155
Curved Arrow .....	157
Direction of Play .....	158
Distance to Goal .....	159
Down and Distance .....	161
Dynamic Formation .....	166
Freehand 2D Line .....	169
Goal Zone .....	170
Laser Eye .....	171
Laser Wall .....	172
Logo .....	173
Magnifier .....	175
Markers .....	177
Measurement Table .....	180
Moveable Players .....	182
Movie .....	184
Multicam .....	185
Offside Marking .....	189
Pitch Zone .....	191
Player Data Track .....	194
Player Grow/Glow .....	196
Player to Player .....	197
Point Map .....	199
Point to Point .....	201
Range .....	203
Red Zone .....	204
Removable Players .....	205
Rounding Angle .....	207
Rugby Gain Lines .....	209
Scores and Badges .....	210
Screen .....	211

Smash-o-Meter .....	212
Sound .....	214
Spotlights .....	215
Tactical Board .....	218
Team Line-up .....	219
Team Line-up Effect in Touch .....	222
Overriding Camera Transitions .....	223
Tennis Score .....	224
Text .....	225
Time Lapse .....	227
Time Lapse Run .....	229
Timer Text .....	230
Title Text .....	231
Track .....	232
User Model .....	234
Vertical Grid Effect .....	235
Video Effect .....	237
Video Filter Effect .....	238
Virtual Ball .....	240
Virtual Camera .....	243
Virtual Camera Live .....	245
Virtual Camera Spline .....	246
Virtual Presenter .....	248
Virtual Stadium .....	253
Zoom .....	255

## Modules and Utilities ..... 256

Asset Manager .....	257
Import/Export Assets .....	258
Add Custom Assets .....	260
Teams .....	262
3D Players .....	264
Customize Player Appearance .....	265
Maintenance .....	266
Back Up .....	266
Data Visualization Module: Soccer (Football) and Rugby Union .....	271
Sportscodes XML Importer .....	277
Video Test Tool .....	279
License Utility .....	280

Appendix A: Keyboard Shortcuts .....	290
Appendix B: Audio Options .....	292
Appendix C: PIERO User Interface Theme .....	293
Appendix D: Asset Descriptions .....	294
Area Textures .....	295
Arrow Textures .....	296
Caption .....	297
Circle Textures .....	298
Colour Palette .....	299
Down & Distance .....	300
End Zone Logos .....	301
Field Goal Line .....	302
Font .....	303
Laser Eye Texture .....	304
2D Line Texture .....	305
Line-up Cards .....	306
Logos .....	307
Markers .....	308
Magnifier .....	309
Movies .....	310
Red Zone .....	311
Safe Area .....	312
Spotlight Base .....	313
Stadium Adverts .....	314
Stadium Grass or Floor .....	315
Stadium Pitch Logos .....	316
Tactical Board Texture .....	317
Text Background .....	318
Text Background Wings .....	319
Title Text .....	320
Appendix E: High Dynamic Range Support .....	321
Appendix F: Third Party Licenses .....	322
2 Clause BSD License Altered (JOGL) .....	324
3 Clause BSD License (ControlsFX) .....	330

3 Clause BSD License (libjpeg-turbo) .....	331
Apache License 2.0 .....	332
Common Public License .....	335
Eclipse Public License 2.0 .....	338
Eclipse Distribution License 1.0 .....	342
GNU Lesser General Public License 2.1 Altered (OpenSceneGraph) .....	343
GNU Lesser General Public License 3.0 .....	349
IJG License .....	352
Mesa3D License (OpenGL) .....	354
Mesa3D Graphics Library License (OpenGL) .....	354
MIT License Modern Variant (Fontconfig) .....	355
MIT License Altered (Freeglut) .....	356
MIT License (TouchBar) .....	357
MIT License (USB4Java) .....	358
Modified Apache License 1.1 (Jdom) .....	359
NDI License .....	360
SGI Free Software B 2.0 License (OpenGL) .....	365
SIL Open Font License 1.1 (Font-Awesome) .....	366
SIL Open Font License 1.1 (OpenSans) .....	369

# Introduction

Thank you for choosing a Ross Video PIERO system.

Ross Video designed PIERO with the needs of live production in mind. PIERO is a system for adding graphics to sports footage to aid in analysis of incidents in the match and illustrate points made by analysts.

We appreciate your business and sincerely hope that you have a great experience with your new PIERO system. As always, if there is anything we at Ross Video can do to assist you, please do not hesitate to contact us.

# About This Guide

This guide covers the use of the PIERO system.

If, at any time, you have questions pertaining to the operation of PIERO, please contact us at the numbers listed in the section [Getting Help](#)<sup>3</sup>. Our technical staff is always available for consultation, training, or service.

## Documentation Conventions

Special text formats are used in this guide to identify parts of the user interface, text that a user must enter, or a sequence of menus and sub-menus that must be followed to reach a particular command.

**Bold text** Bold text identifies a user interface element such as a dialog box, menu item, or button.

For example:

In the **Slug** column, type a slug name for the story.

***Bold Italic text*** Italic text is used to identify the titles of referenced guides, manuals, or documents.

For example:

For more information, refer to the ***DashBoard User Guide***.

`Courier text` Courier text identifies text that a user must type.

For example:

In the **Username** box, type `postgres`.

[Hypertext](#) Identifies a hyperlink to a related topic.

## Getting Help

PIERO documentation is accessible by selecting the **Documents** icon in the PIERO Launcher.

## Contacting Technical Support

At Ross Video, we take pride in the quality of our products, but if problems occur, help is as close as the nearest telephone.

Our 24-hour Hot Line service ensures you have access to technical expertise around the clock. After-sales service and technical support is provided directly by Ross Video personnel. During business hours (Eastern Time), technical support personnel are available by telephone. After hours and on weekends, a direct emergency technical support phone line is available. If the technical support person who is on call does not answer this line immediately, a voice message can be left and the call will be returned shortly. This team of highly trained staff is available to react to any problem and to do whatever is necessary to ensure customer satisfaction.

### Technical Support:

- 1-844-652-0645 (North America)
- +800 3540 3545 (International)
- After Hours Emergency: (+1) 613-349-0006
- E-mail: [techsupport@rossvideo.com](mailto:techsupport@rossvideo.com)
- Website: <http://www.rossvideo.com>

# What is PIERO?

PIERO is a system designed to enhance sports footage with graphical elements that support the analysis of key moments during a match. These graphics range from basic visual aids, such as lines, to more complex effects, including 3D computer-generated imagery (CGI), such as a virtual football stadium. In the 3D stadium, analysts can view the action from perspectives where no physical cameras are present.

Many of these graphical elements are "tied-to-field," meaning they appear to be on the pitch, allowing them to move naturally with the camera as it follows the game, creating the illusion that the graphics are part of the live action.



*PIERO Graphics Examples*

# Getting Started

This section provides an overview of starting and launching PIERO, the PIERO User Interface (UI), and the basic workflow for creating a project in PIERO.

## Starting PIERO

The instructions in this guide apply to systems running macOS or Linux (Ubuntu).

For MacOS, see the [Starting for macOS](#) <sup>[7]</sup> section.

For Linux (Ubuntu), see the [Starting PIERO for Linux](#) <sup>[8]</sup> (Ubuntu System) section.

## PIERO Launcher

Use the PIERO Launcher to access the parameters for setting up your project in PIERO, PIERO's **Modules** and **Utilities**, and launch the PIERO Software.

★ PIERO must always be accessed from the PIERO Launcher.

For instructions on configuring parameter settings in the Launcher, see [Launching the PIERO Software](#) <sup>[10]</sup>.

Once you have configured your parameter settings and launched PIERO, you cannot change the settings. You must close the PIERO application and return to the Launcher to modify your project's parameters and then relaunch PIERO.

## Create a Project

Once the parameters are configured in the PIERO Launcher and the application is launched, you can begin creating a project. The basic workflow for setting up a clip-based project is shown in the illustration below. Although keying and calibration are not required for all effects, to get the most out of all effects, the following workflow is recommended.



*Basic Clip-Based Workflow*

★ If you are using PIERO with an EVS/Mira, see the *PIERO Technical Guide* for information on EVS and MIRA system integration.

## Modules and Utilities

The [Modules and Utilities](#) <sup>[256]</sup> are found on the PIERO Launcher. The options available depend on individual licenses and may include:

**PIERO License Tool**—used to update your USB license.

**Asset Manager**—manages the assets (such as textures, movies, squads) used by PIERO effects.

**Data Visualization Module**—generates graphics from Opta, TRACAB, or STATS data (available as an add-on).

**Documentation Tool**—used to access PIERO documentation such as the PIERO User Guide.

# Starting PIERO

The instructions in this guide reference a system that runs on either macOS or Linux (Ubuntu).

For macOS, refer to [Starting PIERO for macOS](#)<sup>[7]</sup>.

For Linux (Ubuntu), refer to [Starting PIERO for Linux](#)<sup>[8]</sup> (Ubuntu System).

★ Before starting PIERO, make sure your USB license key is plugged in. PIERO will not launch if the USB license key is not plugged in or if it has expired.

# Starting PIERO for macOS

This section covers the procedure for starting PIERO for macOS.

## To start PIERO for MacOS:

1. In your **Applications** folder, select the **PIERO** folder and start the **Launcher** application.

Additionally, you can create a shortcut to the **Launcher** by dragging the **Launcher** to your desktop or dock.

The **PIERO Launcher** appears.

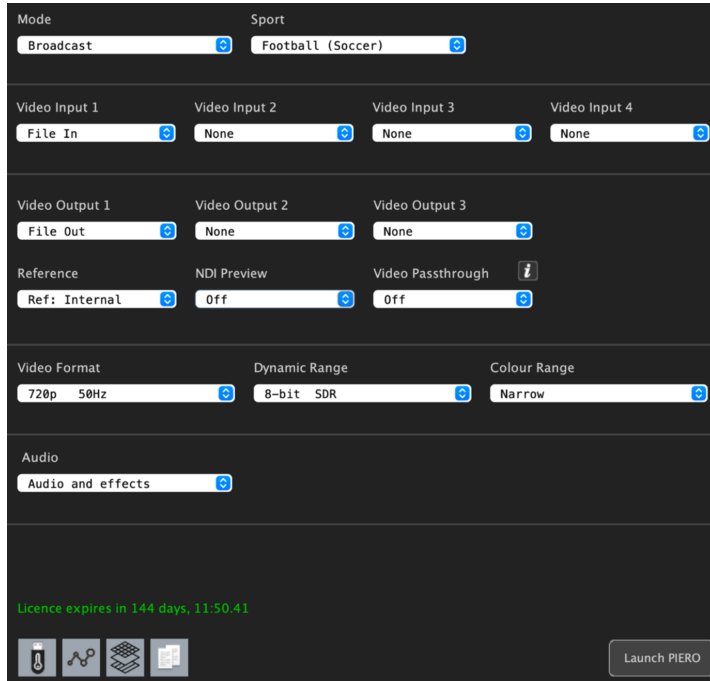

### *PIERO Launcher*

2. At the bottom of the launcher window, verify that your license is still active.

The license expiry date is displayed in green text.

3. Configure the presets for the PIERO edition you are licensed to use.

For instructions on configuring parameters in the launcher, see the [Launching the PIERO Software](#) section.

4. Finish configuring the parameters, then select the **Launch PIERO** button.

PIERO Launches.

# Starting PIERO for Linux (Ubuntu)

This section covers the procedure for starting PIERO for Linux (Ubuntu).

## To start PIERO for Linux (Ubuntu):

1. On the desktop, select the **PIERO desktop** icon, and right-click on the icon to reveal the options menu.



Desktop - PIERO Icon

2. From the options menu, select **Allow Launching**.

★ This step only needs to be done the first time you launch PIERO.

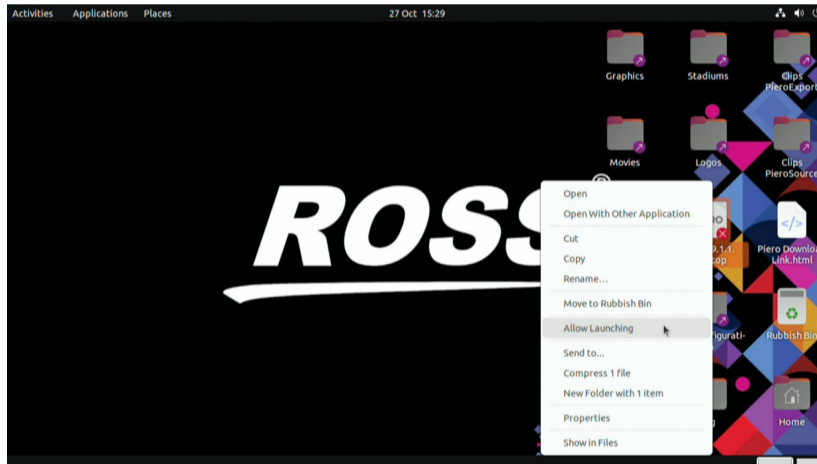

Options Menu - Allow Launching

The PIERO **Launcher** opens.

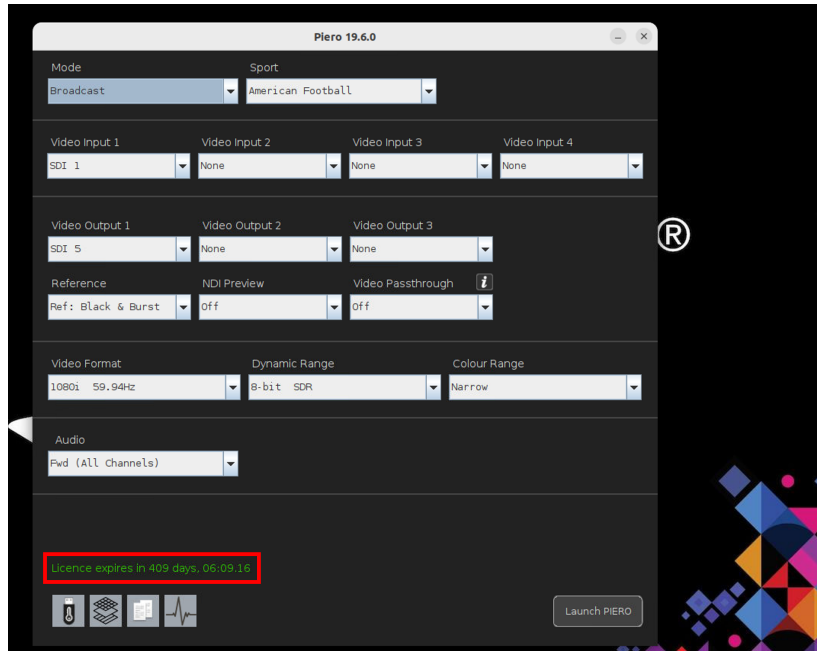

#### *Launcher - License Expiry Date*

3. At the bottom of the launcher window, verify that your license is still active.  
The license expiry date is displayed in green text.
4. Configure the presets for the PIERO edition you are licensed to use.  
For instructions on configuring presets in the launcher, see the [Launching PIERO](#) <sup>10</sup> section.
5. Finish configuring the parameters, then select the **Launch PIERO** button.  
PIERO launches.

# Launching the PIERO Software

Use the PIERO Launcher to access the parameters for setting up a project, manage **Modules and Utilities** <sup>256</sup>, and to launch the PIERO Software.

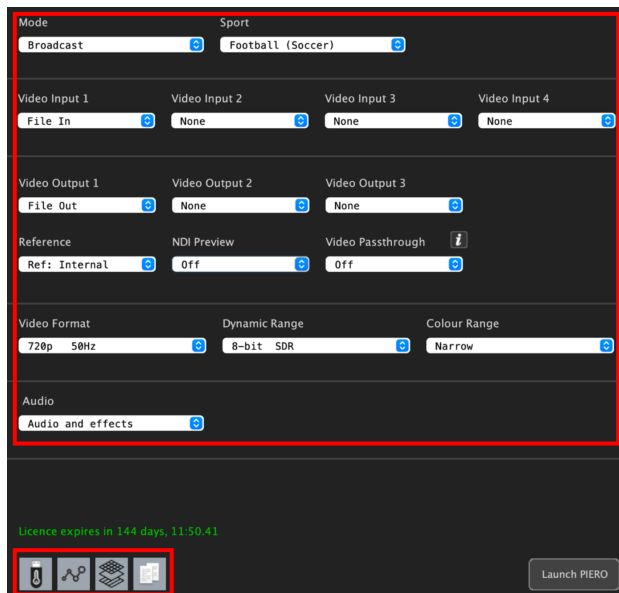

PIERO Launcher

## Parameters

At the top of the Launcher are the parameters. Use the parameters (such as the **mode**, **sport**, **video format**, etc.) to configure the specific settings for your project. The parameter options available to select change depending on the license.

After configuring the parameters, launch PIERO to start creating your project.

## Modules and Utilities

Located at the bottom-left of the Launcher are the **Modules** and **Utilities**. Use the **Modules** and **Utilities** to access the following options, depending on your license:

 **PIERO License Tool**—used to update your USB license.

 **Asset Manager**—used to manage the assets (such as textures, movies, squads) used by PIERO effects.

 **Data Visualization Module**—generates graphics from Opta, TRACAB, or STATS data (available as an add-on).

 **Documentation Tool**—used to access PIERO documentation.

For more information about the **Modules** and **Utilities**, see the **Modules and Utilities** <sup>256</sup> section in this user guide.

# Launching PIERO Broadcast Edition

Use the PIERO Launcher to configure the parameters for your PIERO project and launch the PIERO software.

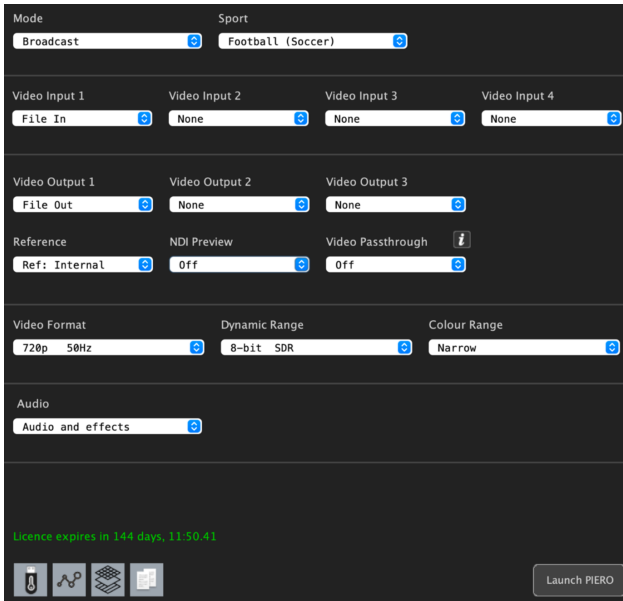

*PIERO Launcher - Broadcast and Live Editions*

## To configure the parameters for the Broadcast edition:

1. From the drop-down menus, make the following selections:

- a. **Mode:** select **Broadcast**.
- b. **Sport:** select the sport for the project.
- c. **Video Input/Output:** select the video input/outputs you are using.
  - ★ For additional information on the **Video Input/Output** options, see the *PIERO Technical Guide*.
- d. **Reference:** select the SDI reference source.
- e. **Video Format:** select the format of the input video or the video file coming into PIERO.
  - ★ **Important:** videos must match the format selected in this section to the format coming into PIERO.
- f. **Dynamic Range:** select the option that matches your video—typically, **8-bit SDR**.
- g. **Color Range:** allows the user to select full or narrow color range on the input and output video.
- h. **Audio:** select the audio option you want.

For additional information on Audio options, see [Appendix B: Audio Options](#)<sup>292</sup>.

2. After selecting the parameters, select **Launch PIERO**.

PIERO launches and you are ready to create a project.

For information on creating a project in PIERO, see [Creating a Project](#)<sup>281</sup>.

# Launching PIERO Club Edition

Use the PIERO Launcher to configure the parameters for your PIERO project and launch PIERO.

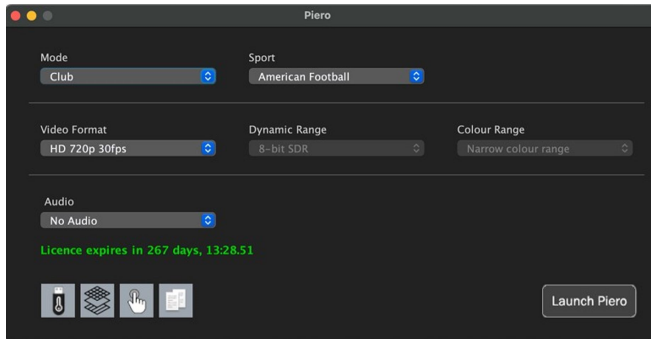

*PIERO Club Launcher*

## To configure the parameters for the Club edition:

1. From the drop-downs, make the following selections:

- a. **Mode:** set to **Club**.
- b. **Sport:** select the sport for the project.
- c. **Video Format:** select the resolution and frame rate of the input video.
- d. **Dynamic Range:** not available in PIERO Club.
- e. **Color Range:** allows the user to select full or narrow color range on the input and output video; this option is not available in PIERO Club.
- f. **Audio:** select the audio option you want.

For additional information on **Audio** options, see [Appendix B: Audio Options](#)<sup>[292]</sup>.

2. After setting the parameters, select **Launch PIERO**.

PIERO launches and you are ready to create a project.

For information on creating a project in PIERO, see [Creating a Project](#)<sup>[28]</sup>.

## Changing PIERO Parameters

If you need to change the parameters after launching PIERO, you will need to close your project and adjust the parameters in the Launcher.

### To change PIERO settings:

1. Close the PIERO application.
2. Open the **Launcher**.
3. In the **Launcher**, adjust the necessary parameters.
4. Select **Launch PIERO**.

PIERO now uses the new settings.

# PIERO User Interface Overview

In the Broadcast and Club editions, there are two UI modes available—**Analysis** and **Touch**.

In the Live edition, there is only one UI mode available—**Analysis**.

**Analysis** is the most fully-featured UI mode. This UI mode allows the addition of effects to the video footage, provides full control of how graphics appear, and allows control of the video device.

**Touch** mode is used with [PIERO Remote Touch](#)  to create presets for Touch effects.

Each edition's UI has many common components and some that are unique to each mode. The common components and workflows are described in the [Broadcast User Interface Overview](#)  section.

The following topics are covered in this section:

[Broadcast Edition User Interface Overview](#) 

[Club Edition User Interface Overview](#) 

# Broadcast Edition User Interface

This section provides an overview of the Broadcast Edition User Interface, as shown below:

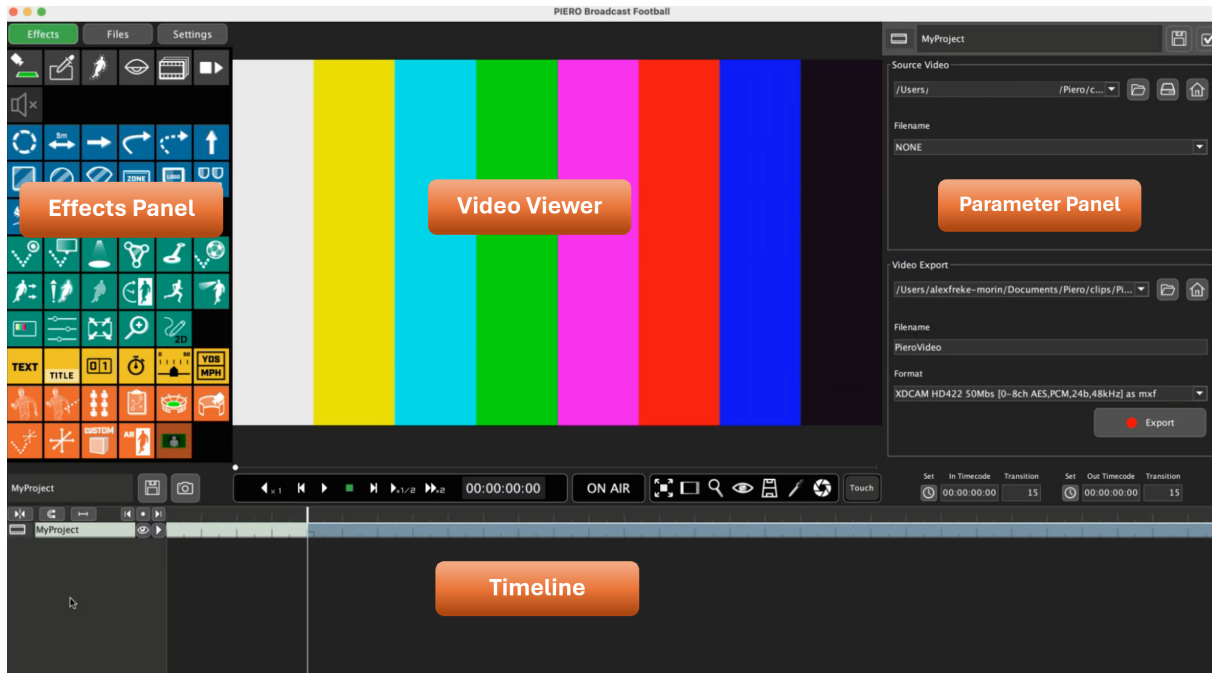

PIERO User Interface

## Effects Panel

At the top-left of the user interface is the **Effects Panel**. Use this panel to access the library of tools and effects that can be applied to a video. The effect options change based on the sport selected in the **Launcher**.

For more information on Tools and Effects, see the [Effects Panel](#) <sup>16</sup> section.

## Video Viewer

In the center of the user interface is the **Video Viewer**, displays the video being edited. Any effects the user applies to the video will be displayed here as well as the final layout when the file is broadcast.

## Parameter Panel

At the top-right of the user interface is the **Parameter Panel**. Use this panel to find and open the Broadcast file displayed in the **Video Viewer**. Additionally, the **Parameter Panel** will display the settings that can be used to configure **Tool** and **Effect** parameters.

## Timeline and Project Panel

At the bottom of the user interface is the **Timeline** and **Project Panel**. Use this panel to manage when effects appear and disappear during the video, and preview the final layout.

For more information on the Timeline and Project Panel, see the [Timeline and Project](#) <sup>22</sup> section.

## Effects Panel

The Effects Panel consists of the following three menus:

[Effects](#) <sup>16</sup>

[Files](#) <sup>17</sup>

[Settings](#) <sup>20</sup>

### Effects

The **Effects** menu provides access to all the PIERO [Effects](#) <sup>124</sup> and [additional tools](#) <sup>74</sup> based on the selected sport:



*Effects Panel - Effects Menu*

In the Effects panel, the effects are grouped by color as follows:

- **Grey**—Function Tools
- **Blue**—Static Effects
- **Green**—Track Effects
- **Yellow**—Text Effects
- **Orange**—Virtual Effects

★ The effects available to select vary depending on the presets you configured in the Launcher.

Selecting an effect icon adds the effect to the project. Once added, effects can be modified for a particular still or sequence, either by using the effect's property sheet displayed in the Parameter Panel or by interacting with the Video Viewer.

When an effect is selected in the project, the Property Panel displays the parameter settings that can be modified (such as color, transition, etc.).

## Files

Use the **Files** menu to access and manage the files associated with the current project.

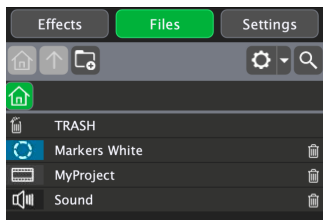

### Files Menu

#### To add a new folder:

1. Select the  **New Folder** button.

Alternatively, you can use the  **Actions** button and select **New Folder** from the menu options.

A new folder appears in the list.

2. In the folder name field, enter the name of the new folder.

The new folder is created.

#### To search for a folder:

1. Select the **Search** button.

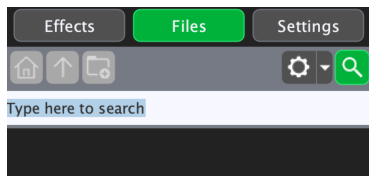

### Files Menu - Search Button

The search field appears.

2. In the search field, enter the name of the file you are searching for.

The file is displayed.

3. Select the **Search** button to return to the main list of files.

#### To delete a file:

- Select the  **Delete** button next to the file you want deleted.

The file is deleted.

## Recovering Deleted Files

When you delete items in PIERO, they are not permanently removed but are moved to the Trash folder. The Trash folder in PIERO serves as temporary storage for deleted items, allowing you to recover files if needed.

### To access deleted files:

- In the **File** menu, select the **Trash** folder.

The **Trash** folder opens, displaying all deleted items along with their deletion date and time.

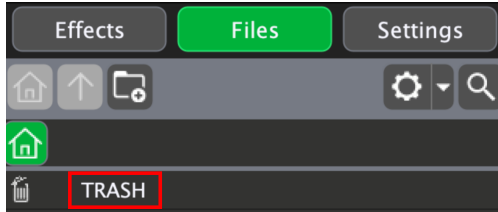

*Files Menu - Trash*

### To restore previous versions of a saved project:

- If you have overwritten a saved project and need to revert to the previous save, right-click on the desired project file in the **Trash** folder and select **Previous Save**.

The file is restored to the previous save.

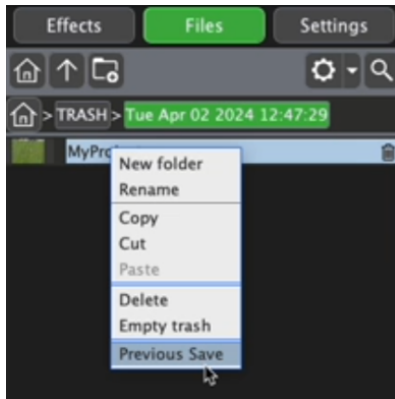

*Deleted File - Previous Save*

### To empty the Trash folder:

- Right-click on the **Trash** folder and select **Empty Trash** from the menu.

The items are permanently deleted.

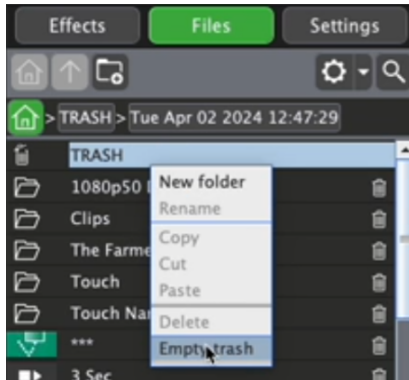

*Trash Folder - Empty Trash*

### To delete a specific item permanently:

- Navigate to the item within the **Trash** folder, right-click on it, and select **Empty Trash** from the options.

The selected item is permanently deleted.

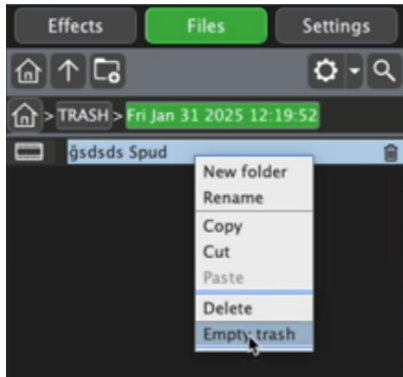

*Deleted File - Empty Trash*

## Settings

Use the **Settings** menu to access and manage the specific project settings such as the **General**, **Video**, and **Touch** settings.

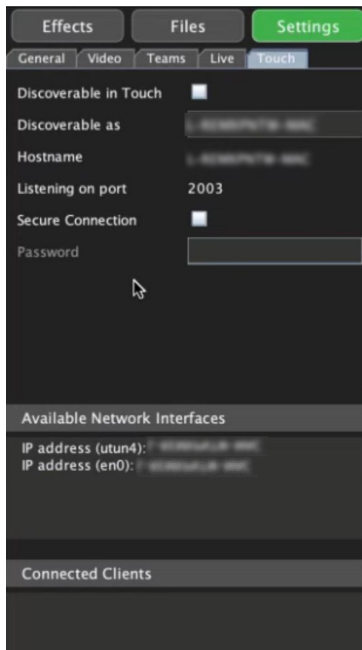

*Settings Menu*

### General Tab

- Select the **Palette** for the color styles used in the effects.
- Select the **Font** style for text used in the effects.
- Select the **Snapshot format** that you will use for taking snapshots.
- Select the desired **UI theme**, either **Light** or **Dark**.
- Select the **Effect Flare** used in the effects.
- Enable or disable the **Small Effect Buttons**.
- Enable or disable the **Power Saving** option.

### Video

In the **Video** tab, you can access the **Display Video Settings** and **Video Configuration** information.

### Teams

In the **Teams** tab, you can select the league, team, colors and Touch Player Captions. These settings are used to ensure accurate team representation in effects such as the Team Line-up effect and when creating customized player overlays in Touch mode.

## Live

In the **Live** tab, you can access the **UDP Tally Controller**, **TCP Tally Controller**, and **DataLinq** settings.

## Touch

Use the **Touch** tab to configure the connection between the PIERO workstation and a Remote Touch device, ensuring seamless control of Touch mode effects via tablets or other touchscreen devices.

## Timeline and Project Panel

This section provides a detailed overview of the following two key components in the user interface: the Timeline and the Project Panel.

### Timeline

The Timeline UI is the primary control center for managing video playback, effect timing, and video editing. It includes essential tools such as the **Video Tape Recorder** (VTR) controls, **Timecode** display, **ON AIR/EDIT** buttons, **Edit** controls, and **UI Mode** selection buttons. The Timeline bar allows users to navigate through video content with precision, monitor timecode information, and manage key operations related to playback and editing.



*Timeline Bar - Edit Mode*

### Timecode

The timecode is a numerical sequence used to uniquely identify each frame in a video timeline. It functions as a reference point, indicating the exact position within the video, represented in hours, minutes, seconds, and frames. Below is an explanation of different background colors that may appear behind the timecode, and what they signify during operation:

- **Red background:** When the timecode is displayed against a red background, it indicates a loss of reference.



*Timecode - Loss of Reference*

- **Amber Background:** When the timecode is displayed against an amber background, PIERO is free-running and is locked to its own internal reference.



*Timecode - Free-Running*

### ON AIR Mode

In **ON AIR** mode, the **Timeline** control panel turns red.



*Timeline - ON AIR Mode*

### EDIT Mode

Deselect the **ON AIR** button to activate **EDIT** mode. When the **Timeline** control panel appears grey, the application is in **Edit** mode.









Use **EDIT** mode for creating, loading and editing effects. Editing handles will be visible in the video window for easy adjustments.



*Timeline - Edit Mode*

## Edit Controls

To the right of the **ON AIR** button are the edit controls, which are described in the following table:

Edit Control	Description
	<b>Fullscreen Video Mode</b> - plays the video clip in fullscreen mode.
	<b>Text Safe Area</b> - displays the safe area for graphics on the video window. Select the safe area button several times to browse through the various safe areas.
	<b>Magnifier Video Tool</b> - magnifies the area beneath the pointer on the video window. Select the button to turn the magnification on or off. Use the mouse scroll wheel to adjust the level of magnification.
	<b>Show the Selected Effect Only</b> - displays a ghost of the selected effect. The ghost is only visible on the monitor screen and does not appear on the video output. It is a good way to ensure the effect is at the right place before pressing <b>ON AIR</b> when working with the PIERO Live Interface
	<b>Calibration Overlay</b> - draws the yellow calibration lines on top of the video. This is only visible on the monitor screen and does not appear on the video output. It helps the operator to see if there is a calibration issue.
	<b>Keyer Overlay</b> - turns the visibility of the <b>Keyer</b> on or off. In <b>Live</b> operation modes only, this allows you to visualize the key and update it in real time if there are any poorly keyed areas.
	<b>Snapshot</b> - saves a single frame of the video clip (at the same resolution as the video) to the desktop.
	<b>Touch</b> - switches the user interface into <b>Touch</b> mode for use with a touch screen or iPad.

## Project Panel

The **Project Panel** is essentially a list of effects that have been selected and is displayed beneath the video display. The **Project Panel** provides a comprehensive view of the effects list, along with a visual representation of when they occur along the timeline. The timeline is responsible for triggering these effects on and off according to their corresponding timecode, offering a clear and structured way to manage and review all applied effects within the project.



### Project Panel

The default name is **MyProject**, but can be edited to something more meaningful.

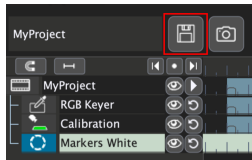

### To save a project:

- In the project panel, select the **Save** button to save the project.



### Project - Save Button

Along the top of the Project Panel are additional Timeline controls, which are described in the following table:

Edit Control	Description
	<b>Collapse clips on the timeline</b> - modifies the start or end point of the effect without changing its overall duration.
	<b>Snap</b> - allows the movement of an effect along the timeline in half-second increments.
	<b>Fix effect length</b> - hides the video segments between clips, ensuring that during playback, only the clips play back-to-back without showing the footage in between.

### To delete a project item:

- Press the **F12** key, or press the **Delete** key.  
If you delete something by accident, press **CTRL + Z** to recover the last deleted item.

## Time Bar

★ The following section outlines the specific visual elements displayed on the timeline, represented as a time bar. While these settings are not typically required during normal operation, it is helpful to have an understanding of their functions.

In the following example, the effect will be active from timecode 00:13:26:17 and will animate on (Transition) over 12 frames. It will remain active until timecode 00:13:29:10 and then animate off (Transition) over 12 frames.



### Timecodes

**Delay** indicates the number of frames at the **In Point** before the effect becomes active. This is normally **0**, however if there is a pause point, then you may want to control when the effect becomes active. For example, if there was a pause point at 00:13:26:17 then with a delay of **0** the effect would start to animate exactly at the pause point. If you want to pause and wait before animating, set the **Delay** accordingly.

These values can be altered manually by typing in new values, or you can simply slide the bars on the timeline, which will automatically update the values.

The animation time is shown as a dark triangle at the beginning and end of the time bar.



### Animation Time Displayed on Time Bar

The time bar can be moved around using the mouse; the ends can be dragged to new positions. The dark triangles at the ends indicate the transition time (i.e. the time the effect takes to animate on and off). The RGB Keyer and calibration effects have no time bar because they are valid for the entire duration of a clip.

### Cue Markers

Cue markers (large red lines at the top of the timeline) bookmark timecodes, helping users quickly navigate to significant moments during editing

Navigate between cue markers to quickly move to another point of interest.



### Cue Markers

#### To add a cue marker:

- In the project panel, select the **Add Marker** button.

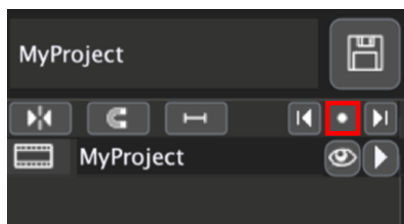

Project Panel - Add Marker Button

Alternatively, you can use the following keyboard shortcut:

**Ctrl + M** = Add a cue marker.

### To move between Cue Markers:

- Use the **Previous Marker** or **Next Marker** buttons to move between the cue markers along the Timeline.

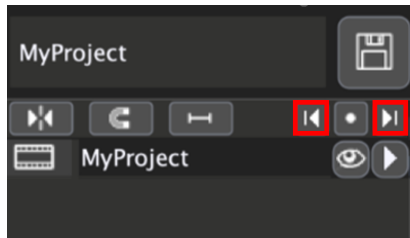

*Project Panel - Move to Previous/Next Marker Buttons*

Alternatively, you can use the following keyboard shortcuts:

**Ctrl + ,** (comma) = Move to previous cue marker.

**Ctrl + .** (period) = Move to next cue marker.

### Multiple Selection

It is possible to select multiple rows on the timeline (in a project). This can allow you to do a variety of things:

- Delete multiple effects at once.
- Change the duration of the selected effects by setting the **In** and **Out** points for the whole selection.
- Hide or show the selected effects by selecting the  **Hide Tool** on the timeline.
- Change common properties of the selected effects.

These common properties will be shown in the property sheet and will vary depending on which effects are selected together. Changes made will apply to all the selected effects on the timeline.

### To select multiple rows:

- Hold the **Ctrl** key and select the rows you want to select.

OR

- Click the first row you want to select, press the **Shift** key and select the last row. All the rows in between will be selected.

★ Pause points will not be selected when selecting multiple rows.

# Club Edition User Interface

The Club edition is a 3D graphics system designed for professional sports clubs. PIERO Club is used as an interface between coaching staff and players to provide visual support when reviewing and preparing a game.

This edition runs on a MacBook Pro laptop, and the user interface is identical to that of the Broadcast edition, but without the SDI option. The settings and options for the Club edition are the same as the Broadcast edition. For information on the settings and options, see the [Broadcast Edition User Interface Overview](#) section in this guide.

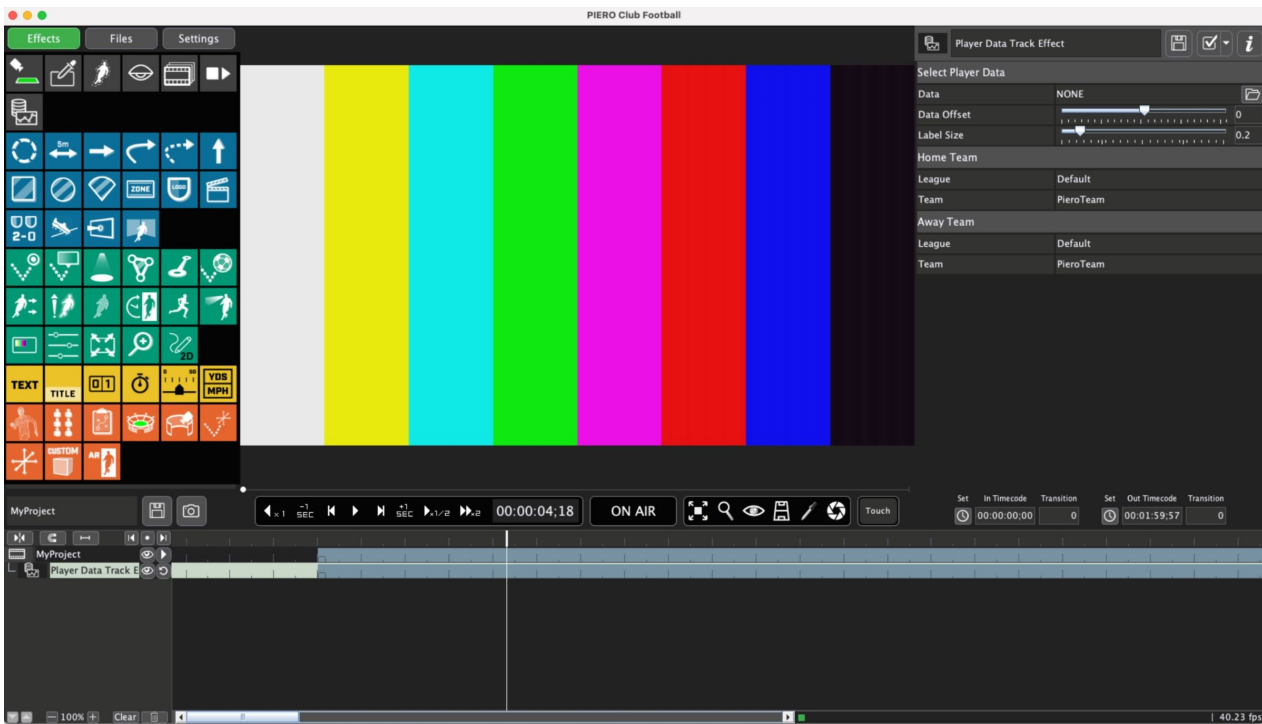

*Club Edition User Interface - Analysis Mode*

# Creating a Project

The section describes a clip-based workflow that helps you create projects in PIERO. While keying and calibration aren't necessary for all effects, the following workflow is recommended to make the most of each effect. A detailed list of effects that require keying and calibration can be found in the [PIERO Effects](#) section.

[Importing a clip](#)

[Keying](#)

[Calibrating](#)

[Adding Effects](#)

[Previewing Final Output](#)

# Importing a Clip

This section provides instructions for importing a clip.

## To import a clip:

1. In the **Parameter Panel**, select the  **Folder Directory** button.

★PIERO defaults to the window shown in the image below. If you have moved away from this window, you can select **MyProject** in the **Timeline** to return to the default window.

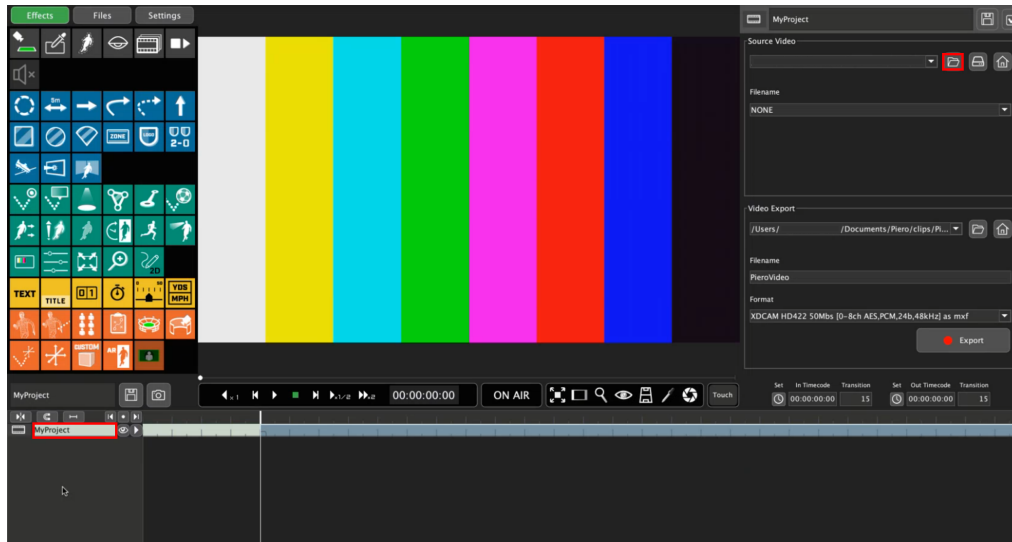

*Parameter Panel and Project Folder Directory*

The file explorer opens.

2. Navigate to the location of the source video and select the video file.

The source video's information is displayed in the **Parameter Panel**, the clip is added to the **Timeline**, and the video is displayed in the **Video Viewer**.



*Clip Import Results - Timeline, Video Viewer, and Parameter Panel*

★ **Note:** If you have selected the wrong video parameters in the Launcher, PIERO highlights the correct video format in red in the Parameter Panel. Close the project and correct the video format in the Launcher, and re-launch PIERO.

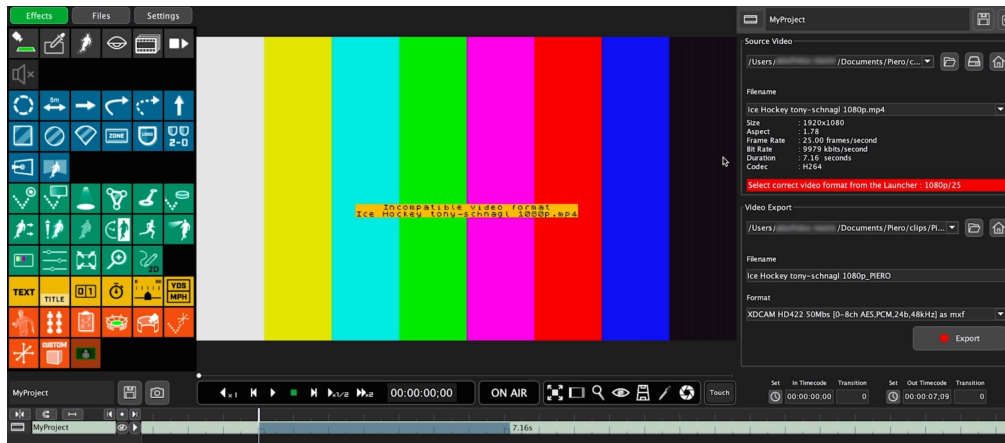

Parameter Panel - Correct Video Format Information Highlighted in Red

3. In the **Timeline**, in the **MyProject** field, enter a name for your project and select the **Save** button.



Project Section - MyProject Field

The project is renamed and saved.

Additionally, you can take a thumbnail image and apply it to your project. For information on how to add a thumbnail, see the [To add a thumbnail to your project](#) procedure.

4. After you import a clip and save your project, continue building your project by [creating a key](#), [calibrating](#), and [adding effects](#).

Although you can add effects at any time, some effects should be added after keying and calibrating. Go to the [Keying](#) section of this guide for information on how to add a key to your project. Once you have added the key, [calibrate the pitch](#).

### To change the project thumbnail:

1. Take a snapshot from your clip to create a thumbnail, as follows:
  - a. Pause the video on the frame you want to use as a thumbnail.
  - b. In the **Timeline**, select the **Snapshot** button to take a snapshot of the current frame.
2. In the project area of the **Timeline**, select the **Add Project Thumbnail** button.

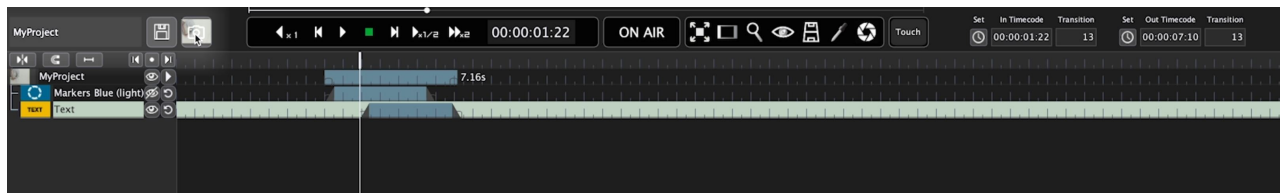

Add Project Thumbnail

The snapshot image is displayed as a thumbnail in front of the project name.

3. Select the  **Save** button to save the change to the project.  
The project is updated and saved.

# Keying

The **RGB Keyer** enables you to create the visual appearance of adding an extra layer of depth to your analysis. Keys are made of two basic components: an alpha that cuts a portion out of the background video, and a fill that replaces that portion with a different video. For example, the RGB Keyer cuts out a player, making a **Marker** effect appear painted on the grass under their feet. If you're pressed for time, effects like **Magnifier** and **Spotlight** can be applied without the RGB Keyer. This flexibility allows you to streamline your workflow while still achieving quality visual effects.

A detailed list of effects that require keying can be found in the [PIERO Effects](#) <sup>124</sup> section.

For example:



*Before Key*

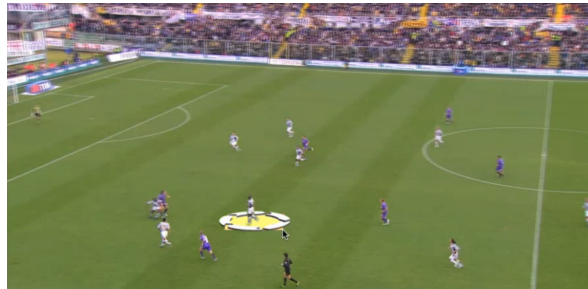

*After Key*

★ **Note:** A detailed list of effects that require keying and calibration can be found in the PIERO Effects section.

## To create a key:

1. In the **Effects Panel**, select the  **RGB Keyer** button.

A **Key** is added to the **Timeline**, and the default **Key** is enabled. The **RGB Key** parameter settings are displayed in the **Parameter** panel.

★ Ensure proper keying for each clip, as it is sensitive to changes in lighting and pitch color. As the default **Key** color is red, change it when working on a red court, such as a clay court in tennis.



*Timeline and Property Sheet - RGB Keyer*

2. In the **Video Viewer**, click and drag a box on different sections of the playing field to set the **Key** color, which is the color of the playing field's surface.

Alternatively, you can use a manual **Key** to select the **Key** color, which is the recommended method, as follows:

- a. In the **Parameter** panel, select the **Clear** button to clear the default **Key**.

The playing field returns to its original color.

- b. Click and drag a box on different positions of the playing field to sample different variations of the playing field's color.

As you add colors to the key, a red overlay in the **Video Viewer** to help you visualize which colors you have added to the key.

With every box you draw, you sample the colors inside it, expanding the list of colors used to build the **Key**. Selecting and dragging in various locations on the field will add more colors to the Key. If necessary, take more color samples at various places in the video, as sometimes the camera may pan in a certain way, revealing a shade that needs more keying. Obtaining samples of the players' shadows on the field is also important in order to ensure accurate key creation.

Additionally, it may be necessary to refine the color selection using the color **Tolerance**, **Brightness**, and **Feathering** sliders located in the **Parameter** panel. This adjustment is often required in scenarios such as a green shirt on a green soccer pitch or a white shirt on ice.

★ If your workflow doesn't require precise key adjustments, you can [save a key as a preset](#)<sup>71</sup>, especially if you have multiple clips from the same day or match using the same camera.

# Calibrating

Calibration is the foundation of everything you will do in PIERO. By accurately calibrating your clips, PIERO can determine where the camera is located and the precise direction it's pointing, allowing graphics to appear seamlessly on the pitch as if they were part of the physical field. This calibration process is vital for applying many of the graphic effects available in PIERO. A detailed list of effects that require calibration can be found in the [PIERO Effects](#) section.

Once you've added the calibration tool to your project, the next step is selecting the appropriate tracker to match the needs of your specific scene. PIERO offers six distinct trackers, each with specialized functionality:

[Line Tracker](#) - tracks white field or court markings in an image.

[Texture Tracker](#) - tracks groups of pixels it finds from one image to the next.

[Cable Cam](#) - tracks moving cameras that film the field, court, or rink from above.

[Telestrator](#) - enables quick alignment of the calibration on a single frame of video.

[KLT Cable Cam](#) - follows the motion of objects in cable cam systems, tracking objects from an overhead or elevated perspective.

[Live Tracker](#) - a fast tracking solution designed for quick setup and short-term use in live broadcasts

Upon selecting a tracker, proceed with the general setup sequence: [positioning the camera](#), [defining the field dimensions](#), and [aligning PIERO's model field with the actual field in the video](#). Following the general setup, refer to the section dedicated to the specific tracker selected for additional configuration details.

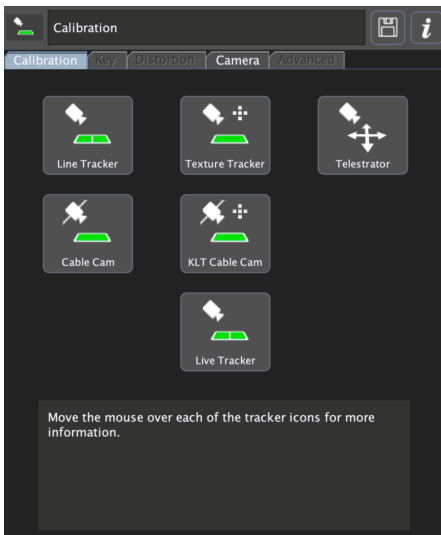

*Calibration Tool - Calibration Parameter Sheet*

## Calibration Tool User Interface Overview

The Calibration Tool UI offers a streamlined interface to support accurate calibration setups in PIERO. This overview explains each tab available in the calibration parameter sheet, detailing essential tools for aligning and configuring calibration settings. Familiarity with these tabs—[Calibration](#)<sup>[36]</sup>, [Key](#)<sup>[36]</sup>, [Distortion](#)<sup>[37]</sup>, [Camera](#)<sup>[37]</sup>, and [Advanced](#)<sup>[38]</sup>—ensures a clear understanding of how to manage calibration parameters effectively, enhancing the precision of graphic overlays on video content.

The following topics are discussed in this section.

[Calibration Tab](#)<sup>[36]</sup>

[Key Tab](#)<sup>[36]</sup>

[Distortion Tab](#)<sup>[37]</sup>

[Camera Tab](#)<sup>[37]</sup>

[Advanced Tab](#)<sup>[38]</sup>

## Calibration Tab

The Calibration tab is the starting point for setting up calibration. It contains tools for selecting a tracker, configuring initial camera alignment, and defining the model dimensions (field, court, or rink) to match the real-world environment in the video. It's used to establish the base alignment for the calibration process.

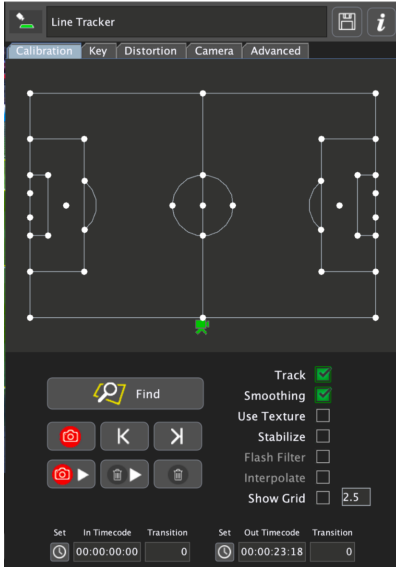

Calibration Tab

## Key Tab

The Key tab includes enhanced controls for adjusting the calibration's internal key settings. It allows users to create a customized key to improve tracking performance by selecting colors in the video window. Options include the **Copy From Project** button for key transfer, and overlays like the **Red Mist** and **Binary Key** view to visualize keyed areas.

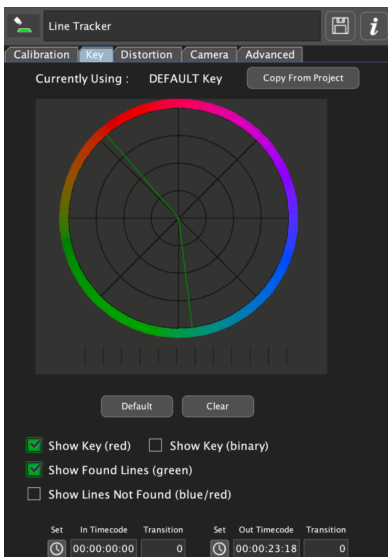

Key Tab

## Distortion Tab

The Distortion tab is available for trackers that support lens distortion correction. It enables calibration of lens distortion, which is useful for optimizing tracking on footage with significant distortion. Tools include the Single Reading and Record Readings methods to build a distortion model for better accuracy.

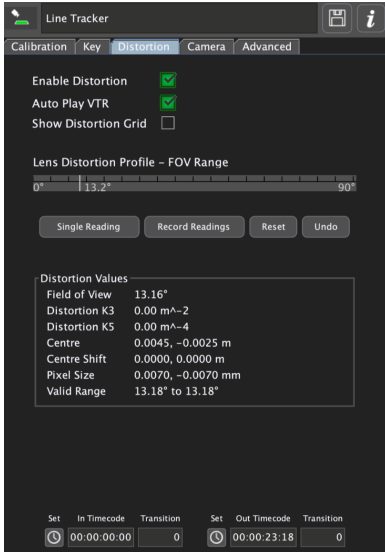

*Distortion Tab*

## Camera Tab

The Camera tab displays real-time information on the camera's position and orientation as per the current tracker. This tab provides position data (X/Y/Z coordinates) and orientation details (pan, tilt, field of view) but does not have adjustable controls.

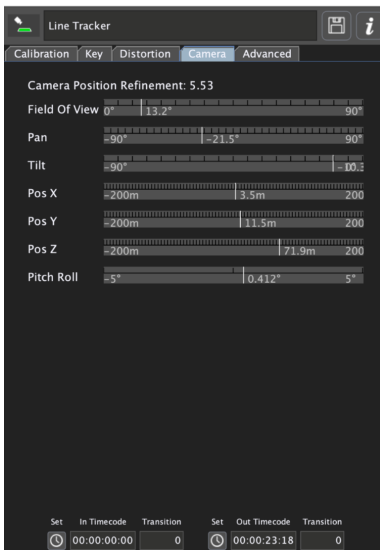

*Camera Tab*

## Advanced Tab

The Advanced tab offers tracker-specific settings that support advanced calibration adjustments. Available options vary by tracker and may include tools like texture visibility, minimum/maximum field of view settings, and tracking thresholds. This tab provides specialized controls to fine-tune calibration for complex tracking scenarios.

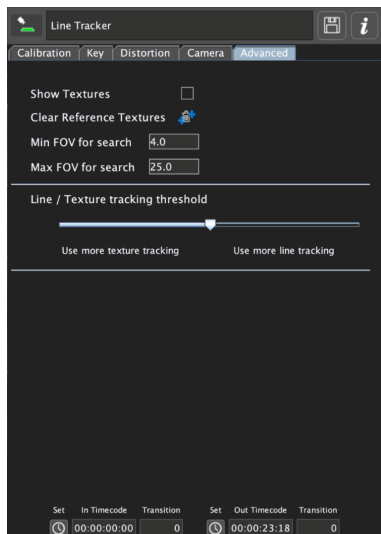

### Advanced Tab

★ The options available vary based on the active tracker.

### Line Tracker Advanced Options

The following table outlines the advanced options available for the Line Tracker, detailing their functionality and usage.

Option	Description
<b>Show Textures</b>	Toggles KLT texture patches on or off in the video window.
<b>Clear Reference Textures</b>	Clears any permanent KLT texture reference patches.
<b>Min/Max FOV for Search</b>	<p>Defines the minimum and maximum field of view (FOV) in degrees and determine the search range for the 1-click realignment method.</p> <p>By checking the camera's approximate FOV in the <b>Camera</b> tab, you can adjust the min and max values to center around this FOV, improving realignment accuracy.</p> <p>For example, if the camera's FOV is generally around 24 degrees, setting the minimum to 20 and the maximum to 30 allows for some variation while optimizing the 1-click realignment. This narrower range (20-30 degrees) has two benefits: (a) it centers the expected FOV within the range, and (b) it reduces the default search range (typically 4-25 degrees), allowing faster realignment.</p> <p>If the shot's FOV falls outside this specified range, the 1-click realignment may not lock on successfully.</p>
<b>Line/Texture Tracking Threshold</b>	<p>Adjust this threshold when the <b>Use Texture</b> option is selected in the <b>Calibration</b> tab.</p> <p>This slider adjusts the balance between line and texture tracking, with the right end prioritizing line tracking and the left end prioritizing texture tracking.</p>

Option	Description
	Keeping the slider centered means the line and texture tracker are balanced and lines will be used when they are tracking well and textures will be used when the line tracker could possibly fail.

### Texture Tracker and Live Tracker Advanced Options

The following table outlines the advanced options available for the Texture and Live Tracker, detailing their functionality and usage.

Option	Description
<b>Show Textures</b>	Toggles KLT texture patches on/off in the video window.
<b>Clear Reference Textures</b>	Clears any permanent KLT texture reference patches.
<b>Min and Max FOV for Search</b>	<p>Defines the minimum and maximum field of view (FOV) in degrees and determine the search range for the 1-click realignment method.</p> <p>By checking the camera's approximate FOV in the <b>Camera</b> tab, you can adjust the min and max values to center around this FOV, improving realignment accuracy.</p> <p>For example, if the camera's FOV is generally around 24 degrees, setting the minimum to 20 and the maximum to 30 allows for some variation while optimizing the 1-click realignment. This narrower range (20-30 degrees) has two benefits: (a) it centers the expected FOV within the range, and (b) it reduces the default search range (typically 4-25 degrees), allowing faster realignment.</p> <p>If the shot's FOV falls outside this specified range, the 1-click realignment may not lock on successfully.</p>
<b>Auto Find</b>	Enables automatic alignment using reference textures acquired through the <b>Grab Reference Textures</b> button in the <b>Calibration</b> tab.
<b>Auto Find Threshold</b>	<p>Controls how closely the <b>Auto Find</b> feature matches the current FOV to the FOV of reference textures.</p> <p>Moving the slider left narrows the match requirement, while moving it right allows for earlier alignment.</p>
<b>Find Drift (frames)</b>	<p>Defines the number of frames over which the tracker moves to a new position.</p> <p>Setting this to 1 frame results in immediate repositioning, while higher values create a gradual transition, preventing abrupt jumps in on-air graphics.</p>

### KLT Cable Cam Options

The following table outlines the advanced options available for the KLT Cable Cam, detailing their functionality and usage.

Option	Description
<b>Show Textures</b>	Toggles KLT texture patches on/off in the video window.

## Cable Cam Options

No advanced options are available for the Cable Cam—the **Advanced** tab is disabled for this tracker.

## Telestrator Options

The following table outlines the advanced options available for the Telestrator options, detailing their functionality and usage.

Option	Description
<b>Show Textures</b>	Toggles KLT texture patches on/off in the video window.

## General Setup

This section provides the general steps required for successful camera calibration in PIERO. These initial steps—[calibrating the camera position](#)<sup>[42]</sup>, [defining the model of the field](#)<sup>[44]</sup>, court, or rink, and [aligning the model with the video image](#)<sup>[45]</sup>—are essential for ensuring accurate tracking and realistic placement of graphics. Completing these steps establishes the baseline camera calibration that all trackers in PIERO rely on. Once the general setup is complete, you can proceed to the section for your selected tracker to apply specific tracking adjustments.

The following topics are covered in this section:

[Setting up the Camera Position](#)<sup>[42]</sup>

[Defining the Field/Court/Rink Model](#)<sup>[44]</sup>

[Matching the Model to the Image](#)<sup>[45]</sup>

## Setting up the Camera Position

This section covers setting up the camera position to achieve precise calibration in PIERO. Properly setting the camera position establishes a solid foundation for all subsequent calibration steps, ensuring that graphics appear seamlessly integrated with the physical environment.

### To set up the camera position:

1. In the **Effects** panel, select the  **Calibration** tool button.

The **Calibration** is added to the **Timeline** and the **Calibration's** parameter settings are displayed in the **Parameter** panel.

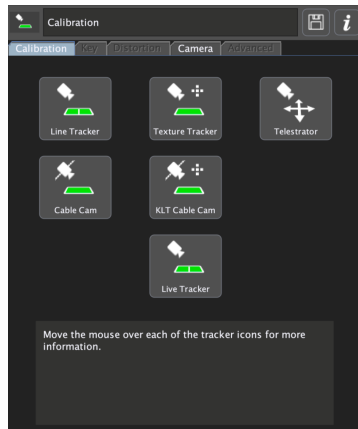

*Calibration Tab*

2. In the **Parameter** panel, select the **Calibration** tab.
3. Select a tracker option.

A grid is placed over the playing field in the **Video Viewer** and a diagram of the pitch model is displayed in the **Parameter** panel.

4. In the **Parameter** panel, the default camera showing the user's perspective is highlighted in green.

If the default camera view does not match the perspective in your clip, you can adjust the camera view by selecting a  **Camera Position** button along the diagram that corresponds to the correct camera view in your clip.

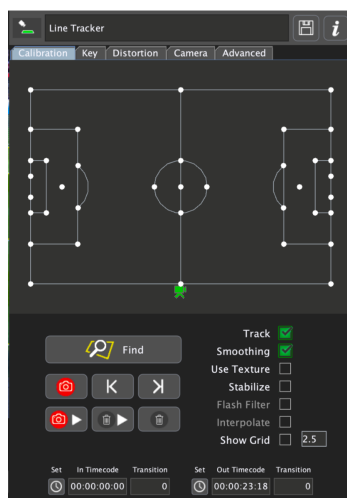

*Calibration Tab - Camera Positions*

5. Define the field/court/rink dimensions.

Below the diagram of the pitch is where you define the pitch dimensions. You can use the **Default Dimensions** option or if you have a non-standard pitch, you can manually set the dimensions.

For instructions on how to define the dimensions, see the [Defining the Field/Court/Rink Model](#)  section.

6. Once you have defined the dimensions, select **Next**.

The calibration points are displayed on the diagram of the pitch.

7. Next, match the field, court, or rink markings in the **Calibration's** model to similar points on the field in the **Video Viewer**.

This enables the **Calibration** to calculate the position of the camera.

For instructions on how to match the model to the image, see the [Matching the Model to the Image](#)  section.

## Defining the Field/Court/Rink Model

The **Calibration** tab provides a model representing the standard field, court, or rink markings for the selected sport, based on regulation dimensions. However, actual dimensions can vary by venue. For optimal calibration results, users should adjust the model's dimensions to closely match those of the field, court, or rink in the video, as precise dimensions are essential for achieving a smooth and high-quality calibration.

To streamline this adjustment process, preset options are available for saving and quickly accessing customized model settings. These options make it easy to reuse customized calibration settings. Two tools enhance the flexibility of the preset options:

- **Last Dimensions** – available in the **Preset** drop-down menu.

This option recalls the last saved or deleted model state. This allows users to quickly retrieve their most recent calibration settings without needing to manually save each version.

- **'U' Shortcut Key** – pressing the 'U' key at any point will automatically save the current model setup as a preset.

This preset is added to the list and will display under the current effect name (as shown at the top of the property sheet).

### To define the field/court/rink model:

1. Below the model, from the **Preset** drop-down, select one of the preset pitch dimensions.

Alternatively, if the precise width and length are known, use the **Pitch Width** and **Pitch Length** fields to set the pitch dimensions to match those of the venue in the video



#### *Model Dimensions*

2. Select **Next**.

The property sheet is updated for the next phase of the camera position calibration.

3. Next, you need to match the field, court, or rink markings in the calibration's model to those on the field, which enables the calibration to calculate the position of the camera.

Go to the [Matching the Model to the Image](#) section for further instruction.

## Matching the Model to the Image

Once the camera position has been selected and the field, court, or rink dimensions have been updated, you need to match the field, court, or rink markings in the **Calibration's** model to those in the image. Matching the model to the image enables the **Calibration** to calculate the position of the camera.

There are three methods to match the model to the image:

[One-Click Method](#) 

[Points Method](#) 

[Lines Method](#) 

## One-Click Method

The **One-Click** method is specifically designed for sports where the field or court lines are white. This tracking method requires two sets of parallel white lines, a feature typically found in sports like soccer (football). Due to this requirement, the **One-Click** method is best suited to this sport.

### To use the One-Click method:

1. In the **Calibration tab**, select one of the calibration points on the model that corresponds to the matching point on the field in the current frame of video.

The selected calibration point on the model turns red when it is selected.

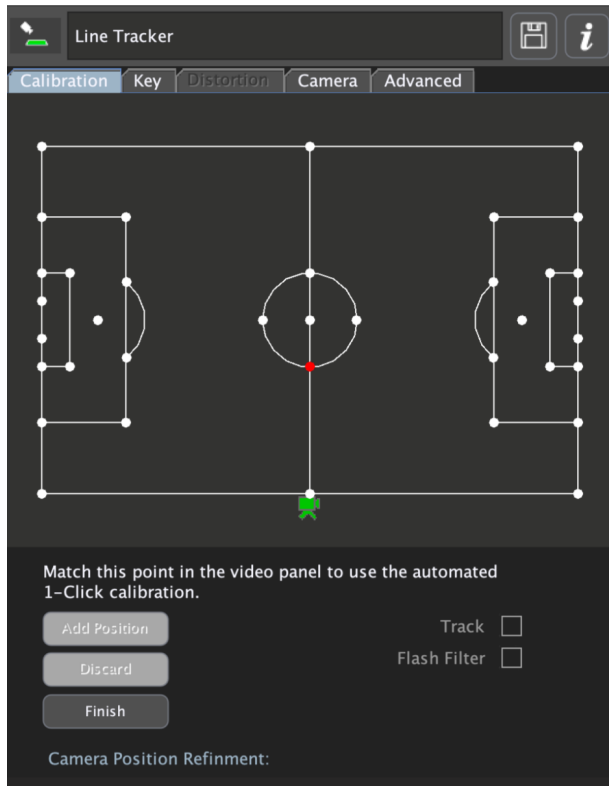

*Calibration Model - Calibration Point Highlighted in Red.*

2. In the **Video Viewer**, select the corresponding point

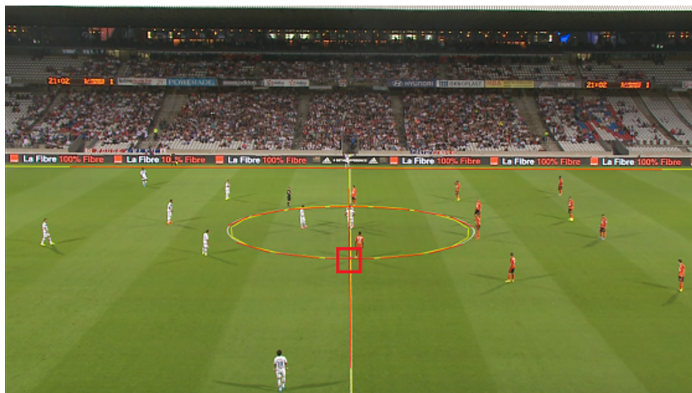

*Corresponding Point Selected In the Frame of Video.*

3. Refine the position of the yellow lines that have been overlaid on top of the markings in the image.  
See [Refining the Position](#) <sup>[51]</sup> for instructions.

4. Select **Add Position** to accept the position for this frame.

★ The video needs to remain on the same frame until the **Add Position** has been selected.

5. Repeat the process at another frame, or frames, in the video where the camera is facing another direction.

★ While this step is recommended, it is optional. If you already have a good track and the camera movements are not too erratic, it may not be necessary.

6. Select **Finish** to lock in the camera position.

7. Next, you will need to track the scene.

Proceed to the section for your selected tracker to apply specific tracking adjustments.



### Tips

- Select **Discard** to start over.
- Refine the position by using either the [Click Refinement](#) <sup>[51]</sup> or [Line Refinement](#) <sup>[51]</sup> methods.
- Add multiple positions at different points in the video, where the camera is facing different directions, to produce a more accurate camera position.
- It is best practice to key properly before calibrating. If the calibration has not worked well, try updating the calibration's internal keyer to help the **One-Click** method find white lines in the image.

## Points Method

The **Points** method takes slightly longer than the **One-Click** method but can be used on any sport, not only those with white lines.

### To use the Points method:

1. Go to the frame in the video where you want to begin.
2. Click and drag over an area on the model, covering multiple points.

The area covered must be visible in the current frame of video.

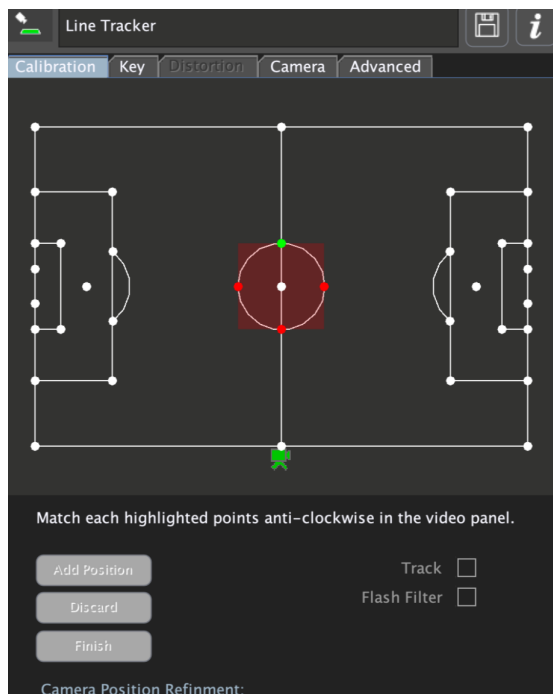



### Calibration - Points Method

A number of points will be selected, one of which will be green.

3. Click on the point in the frame of video that corresponds to the green point on the model.  
Another point will turn green.
4. Repeat the process until you have matched all the green points.
5. Refine the position of the yellow lines that have been overlaid on top of the markings in the image.  
See [Refining the Position](#) for instructions.
6. Click **Add Position** to accept the position for this frame.
7. Repeat the process at another frame, or frames, in the video where the camera is facing another direction.
8. Click **Finish** to lock in the camera position.
9. Next, you will then need to track the scene. Proceed to the section for your selected tracker to apply specific tracking adjustments.



### Tips

- Click **Discard** to start over.
- Refine the position by using either the [Click Refinement](#)  or [Line Refinement](#)  methods.
- Add multiple positions at different points in the video, where the camera is facing different directions, to produce a more accurate camera position.

## Lines Method

The **Lines** method takes longer than the **One-Click** or **Points** methods, but is useful in difficult situations where the other methods do not provide a satisfactory result.

Before you start, ensure you have properly keyed. For information on keying, see the [Keying](#) <sup>[32]</sup> section.

### To use the Lines method:

1. Go to the frame in the video where you want to begin.
2. Click on a line in the model that is visible in the current frame of video.

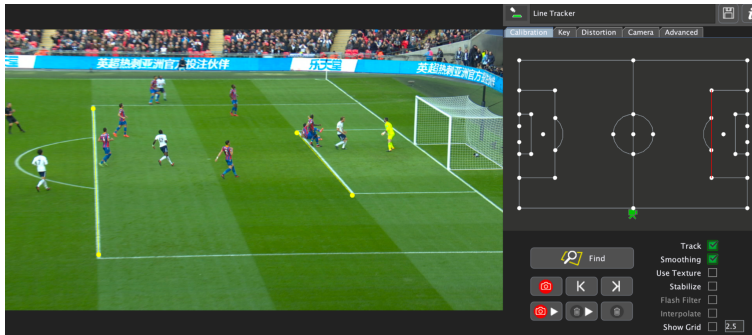

*Calibration - Lines Method*

3. Draw the line over the top of the corresponding line in the frame of video.
4. Repeat the process until you have drawn at least two sets of parallel lines (four lines), two vertical and two horizontal.
5. Refine the position of the yellow lines that have been overlaid on top of the markings in the image.  
See [Refining the Position](#) <sup>[51]</sup> for instructions.
6. Click **Add Position** to accept the position for this frame.
7. Repeat the process at another frame, or frames, in the video where the camera is facing another direction.
8. Press **Finish** to lock in the camera position.
9. Next, you will then need to track the scene. Proceed to the section for your selected tracker to apply specific tracking adjustments..



### Tips

- After drawing a line, you can drag either end to position it better.
- Click **Discard** to start over.
- Refine the position by using either the [Click Refinement](#) <sup>[51]</sup> or [Line Refinement](#) <sup>[51]</sup> methods.
- Add multiple positions at different points in the video, where the camera is facing different directions, to produce a more accurate camera position.

## Refining the Position

Before selecting the **Add Position** button, if the yellow lines overlaid on top of the field, court or rink markings are misaligned, use one of the following methods to refine the position of the overlay so that it matches the markings in the video as closely as possible.

[Click Refinement](#) 

[Line Refinement](#) 

### Click Refinement

You can refine the position of the overlay by correcting the position of pink dots that appear in the video window.

#### To use Click-Refinement:

1. In the video window, move the cursor near to the intersections between the overlaid yellow lines and you will see pink dots appear.

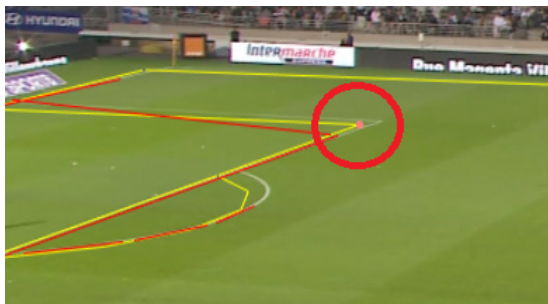

*Calibration - Click Refinement*

2. If the position of the pink dot does not match the correct location in the frame of video, select the corresponding point in the image.

The dot and lines will reposition themselves. Try to align them with the image.

3. Repeat the process until you are happy with the alignment.
4. Click Add Position when you have finished.

### Line Refinement

You can refine the position of the overlay by drawing more lines.

#### To use Line Refinement:

1. Select a line from the model that is misaligned in the video.
2. Draw the line over the top of the corresponding line in the frame of video.
3. Repeat the process for other lines that need aligning with the video.
4. Click **Add Position** when you have finished.

## Updating the Calibration's Internal Keyer

When using the **Line Tracker**, use the **Key** tab to update the calibration's internal keyer.

★ Update the calibration's internal keyer when working on sports that have non-green and multi-colored playing surfaces, such as hard-court and clay-court tennis.

The **Key** tab includes enhanced controls for adjusting the calibration's internal key settings. It allows users to create a customized key to improve tracking performance by selecting colors in the video window.

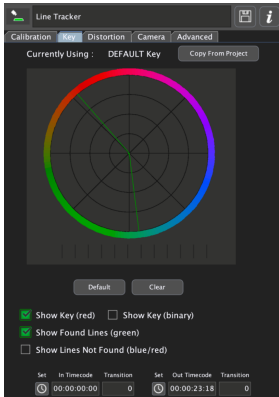

### Key Tab

Below the **Copy From Project** button, a color wheel representing the HSL (Hue, Saturation, Lightness) space is displayed. This circular component shows the full 360 degrees of hue, with a color bar running around the edge to indicate each hue's corresponding color. Moving from the center to the outer edge represents an increase in saturation, while a separate bar below the circle illustrates lightness from dark (left) to light (right).

By default, the **DEFAULT** key is used for the calibration's internal keyer. The default key is represented as a wedge on the color wheel, covering hues from red-brown through green-blue, with no additional radial lines, allowing for the full range of saturation and lightness.

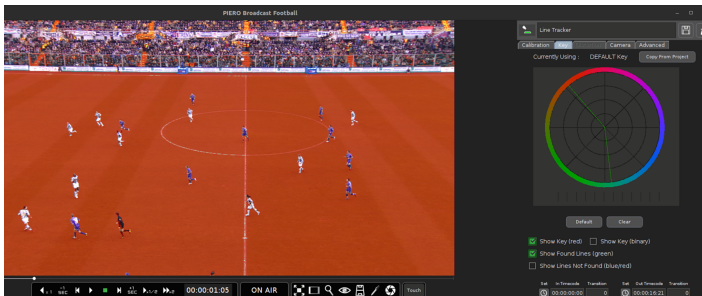

### Calibration's internal Default Key - Wide Hue Angle

This tab also provides two overlay options for visualizing the key directly in the video window:

- **Red Mist Overlay:** Displays areas identified as key in red, with non-key areas showing as the true video, ideal for verifying that the playing surface is keyed while players and lines remain visible.
- **Binary Key Overlay:** An alternative view where key areas are black and non-key areas are white.

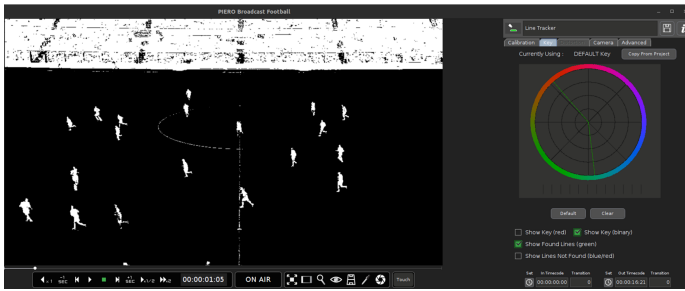

### Binary Key Representation of the Calibration's Internal Key

These overlays can be toggled using the **Show Key (red)** and **Show Key (binary)** checkboxes. If neither is selected, no key representation will appear in the video window.

Additional controls on this tab allow users to customize the key further:

- **Clear Button:** Clears the key entirely, removing all keyed areas.
- **Default Button:** Resets the key to the default starting settings.

Users can define a custom key by dragging areas in the video window to add specific colors to the key. As colors are added, the color wheel updates with new “wedges” representing the hues, saturation, and lightness of the selected pixels. Multiple colors can be added to accommodate varied surfaces, resulting in multiple wedges on the wheel.

### To remove a specific wedge:

- Select the wedge (the wedge will highlight in white) and press the **Backspace** key.  
The wedge is removed.

The following four color wheel views depicted in the image below illustrate different key configurations:

- **Top Left:** Empty key.
- **Top Right:** Single color added.
- **Bottom Left:** Multiple colors added.
- **Bottom Right:** Selected wedge highlighted in white.

★ **Note:** Editing the key directly in the **Key** tab can often replace the need for the **Copy From Project** button, although users may still use it as desired. The **Key** tab only becomes active when changes to key settings will affect the tracker. If it is disabled, it indicates that the tracker has not yet been fully created.

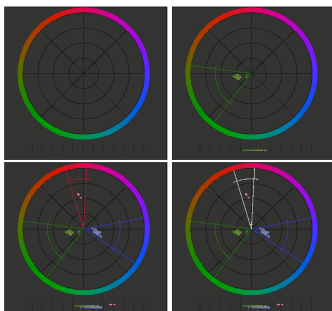

Color Wheel Views

## Line Tracker and Texture Tracker

The Line Tracker focuses on tracking white field or court markings, while the Texture Tracker identifies and follows groups of pixels across frames. This section provides a detailed explanation of each tracker's key features and setup, including options for optimizing tracking performance in various environments.

[Line Tracker](#)  55

[Texture Tracker](#)  57

## Line Tracker

The **Line Tracker** tracks the white field or court markings in the image.

When the **Finish** button is selected, PIERO computes all of the possible positions where the field or court lines could be in the image, based on the calibration of the camera position that has just been completed. Once this process is complete, the **Find** button is enabled.

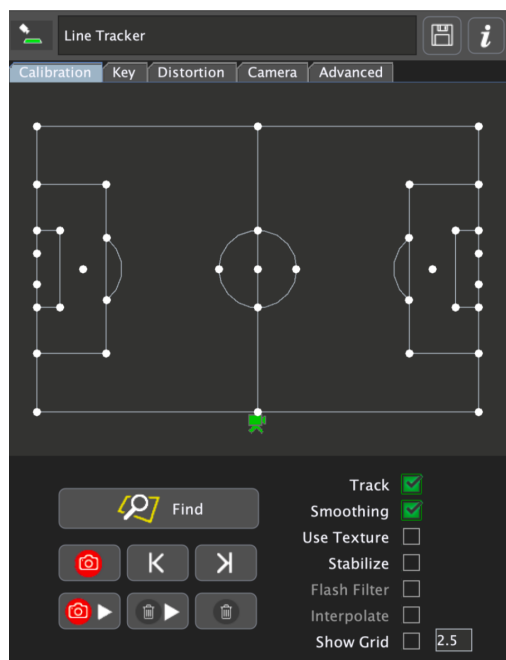

*Calibration - Tracking Options for Line Tracking*

## Key Features

- The **Track** checkbox enables/disables the tracking. It is enabled by default after the camera calibration stage has been completed.
- The **Smoothing** checkbox enables/disables the smoothing feature. Enabling smoothing can help steady the calibration if it shakes a little or drifts as the camera pans and can prevent it from jumping.
- The **Use Texture** checkbox enables/disables combined line and texture tracking. It is disabled by default when the **Line Tracker** has been selected. Enabling it can help on sections of video where the **Line Tracker** struggles to find lines (when the camera zooms in for example).

When enabled, the calibration will automatically switch between line and texture tracking based on a threshold set in the **Advanced** tab of the calibration and will choose the best tracker based on its analysis of the image.

### To use the Line Tracker:

1. Select **Find** to get the calibration to search for white lines in the image.

When the calibration has successfully found enough lines, it will show the yellow markings overlaid on top of the white markings present in the image.

2. Play the video.

The calibration will track the lines.

3. If you need to move to another point in the video, select **Find** to realign the calibration.

The calibration phase is complete and effects that require calibration can now be added to your project. For information on adding effects to your project, see [Adding Effects](#) <sup>68</sup>.

## Optional Steps:

- Select the **Use Texture** box to enable combined line and texture tracking.
- Add **Record Points** or record the calibration to maintain its alignment with the image.



### Tips

- If the calibration is not aligned because you have moved to a different place in the video, press the Find button to realign the calibration with the image.
- If pressing **Find** doesn't work, try moving to a different part of the video where more white lines are visible.
- Selecting the **Use Texture** will enable combined line and texture tracking. Enable this when you find there are areas of video where the line tracking alone struggles to track.
- Add a **Record Point** after pressing **Find**, to lock in the position of the calibration on a single frame of video.
- Use the **Record Calibration** button after pressing **Find** to lock in the position of the calibration over a sequence of video.

This is helpful when working on prerecorded video as it means that you do not need to press **Find** to realign the calibration with the image.

- When using the **Line Tracker** calibration, the **Distortion** tab will be enabled after the camera position has been calculated. Use the Distortion tab to Calibrate Lens Distortion. For more information, see the [Calibrating Lens Distortion](#) <sup>59</sup> section.

### To reuse a Line Tracker calibration:

1. When calibrating the camera position, make sure you have added positions at both ends of the field or court.
2. Remove any **Record Points/Record Calibration**.
3. Save the calibration by selecting the **Save** icon on the property sheet.
4. When you need to use this calibration again, right-click the calibration icon in the effect panel to bring up a list of saved calibrations.

# Texture Tracker

The **Texture Tracker** tracks groups of pixels it finds from one image to the next.

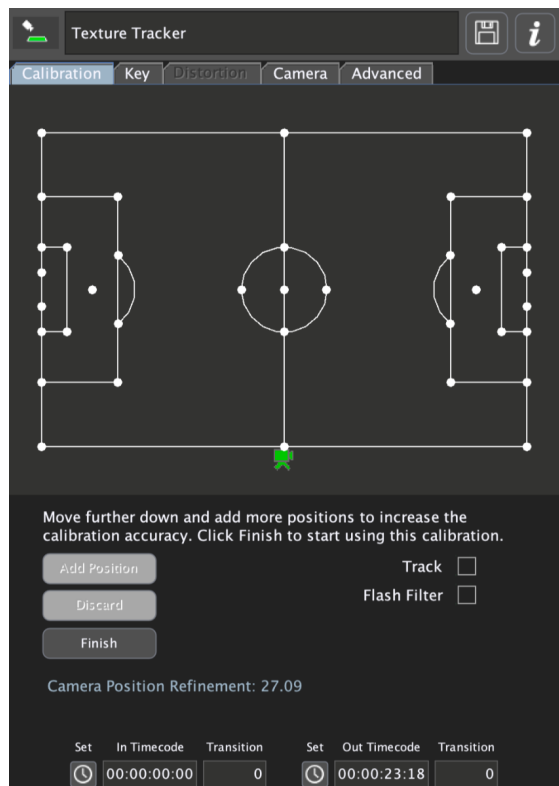

Calibration - Texture Tracker

## Key Features

- The **Track** checkbox enables/disables the tracking. It is enabled by default after the camera calibration stage has been completed.
- The **Flash Filter** checkbox enables/disables the **Flash Filter** feature, which is available only for texture tracking.

Enable this on ice hockey, basketball or any sport where the play takes place on a reflective surface. The **Flash Filter** filters out camera flashes that reflect off of the playing surface that can cause the **Texture Tracker** to lose tracking.

- The **Grab Reference Textures** button takes a snapshot of texture within the image, which is used when pressing the **Find** button to realign the calibration with the image.

These reference textures are also used during the tracking process and can help the **Texture Tracker** track in more difficult situations.

### To use the Texture Tracker:

1. Use one of the methods ([One-Click](#)<sup>[54]</sup>, [Points](#)<sup>[54]</sup>, or [Lines](#)<sup>[54]</sup>) to align the field, court or rink model with the image.  
Skip this step if it is already aligned on the current frame of video.
2. Ensure the **Track** checkbox is selected to enable tracking.
3. Press the **Grab Reference Textures** button to enable the **Find** feature.

4. Play the video.

The calibration will track the image.

5. Add **Record Points** or record the calibration to maintain its alignment with the image.



### Tips

- If the calibration is not aligned and **you have used** the **Grab Reference Textures** button at different points in the video, press the **Find** button and PIERO will attempt to realign the calibration with the image. **Find** will work on images where there is enough similarity to the ones where you have grabbed reference textures.
- If the calibration is not aligned and **you have not used** the **Grab Reference Textures** button at different points in the video, or you have and **Find** is not working, use one of the methods ([One-Click](#)<sup>[54]</sup>, [Points](#)<sup>[54]</sup>, or [Lines](#)<sup>[54]</sup>) to align the field, court or rink model with the image.
- Add a **Record Point** after pressing **Find** or aligning the calibration, to lock in the position of the calibration on a single frame of video.
- Use the **Record Calibration** button after pressing **Find** or aligning the calibration, to lock in the position of the calibration over a sequence of video. This is helpful when working on prerecorded video as it means that you do not need to realign the calibration with the image.

## Calibrating Lens Distortion

When using the **Line Tracker** calibration, the **Distortion** tab will be enabled after the camera position has been calculated. The calibration can calculate lens distortion to help with tracking performance and data visualization on heavily distorted images. The calibration relies on the sport's white field or court markings in the image to calculate lens distortion.

★ The **Lens Distortion** calibration can be completed, reset or amended at any time.



Calibration - Distortion Tab

## Single Reading Method

The **Single Reading** button takes a snapshot of the lens distortion for the current frame of video. Once the calibration has been given two of these readings, on different frames, it will build a distortion model that will be applied to the tracking. This will be visible as the yellow field markings overlaid on the video image begin to distort and match the distorted white lines of the field itself.

The goal is to give the calibration enough information so it can accurately calculate the lens distortion. Select frames of video that represent different zoom levels, representative of when the camera zooms out wide and when it zooms in tighter, as well as where the camera is pointed at different ends of the field or court (left-hand side, middle, right-hand side). Giving the calibration more readings enables it to calculate lens distortion more accurately for a wider range of fields of view.

### To take single readings:

1. Go to a frame of video you want to use to calculate the lens distortion.
2. Press the **Single Reading** button.
3. Repeat the previous two steps at least one more time to give the calibration enough information so it can give an accurate calculation of the lens distortion.

## Record Readings Method

The **Record Readings** button makes the calibration continuously take snapshots of the lens distortion on its own, until it is stopped by the user.

In **Analysis** mode the video will play by itself after the button has been pressed. In **Live** mode, the PIERO operator will need to ask the camera operator to pan the camera and zoom in and out during the setup before the game takes place, so they can build a lens distortion calibration that will cover the fields of view expected during the upcoming game. As distortion data is gathered the yellow field markings overlaid on the video image will begin to distort and match the distorted white lines of the field itself.

Pressing **Record Readings** a second time will stop the process. At this point, the calibration builds a lens distortion model based on the data it has gathered. The wider the range of fields of view covered during the recording, the more accurate the lens distortion calibration will be.

### To record readings:

1. Go to a frame of video where you want to start grabbing snapshots of lens distortion information.
2. Press the **Record Readings** button.
3. Press the **Record Readings** button again when you are happy with the range of fields of view that has been covered.



### Tips

- If you notice that the **Line Tracker** is struggling to track due to distortion, use the **Single Reading** method to get a range of values first, which can then be built upon using the **Record Readings** method. This will produce better results.
- The range of fields of view covered in the calibration process is displayed in green on the **Lens Distortion Profile – FOV Range** meter in the calibration's **Distortion** tab.
- The distortion profile that has been created can be turned on or off using the **Enable Distortion** checkbox.
- If you notice that the overlaid yellow lines are not matching the white lines on the field or court, check whether the **Lens Distortion Profile – FOV Range** meter value has gone outside of the green region. If you need the lens distortion to be calculated for this section of video, simply select a frame of video and take another **Single Reading** or continue to **Record Readings**.
- Due to the quantity of data gathered when using the **Record Readings** method, the resulting lens distortion calibration is likely to be better than one created using the **Single Readings** method.

## Cable Cam

The **Cable Cam Tracker** is designed to track moving cameras that capture footage of a field, court, or rink from an overhead perspective.

### To perform a Cable Tracking calibration:

1. In the **Effects Panel**, select the **Calibration Tool**.
2. In the **Parameter Panel**, in the **Calibration** tab, select **Cable Cam**.
3. Update the field, court, or rink dimensions and select **Next**.
4. Select a camera from the pitch model that is the nearest match to the direction in which the cable cam is pointing.
5. Use the [One-Click](#)<sup>[46]</sup>, [Points](#)<sup>[48]</sup> or [Lines](#)<sup>[50]</sup> method to calculate the camera position, selecting **Add** to record each position.
6. Repeat the process across multiple points in the video for the best results.
7. Then press **Finish**.
8. Select the **Track** checkbox to enable tracking or the **Interpolate** checkbox to interpolate between record points.

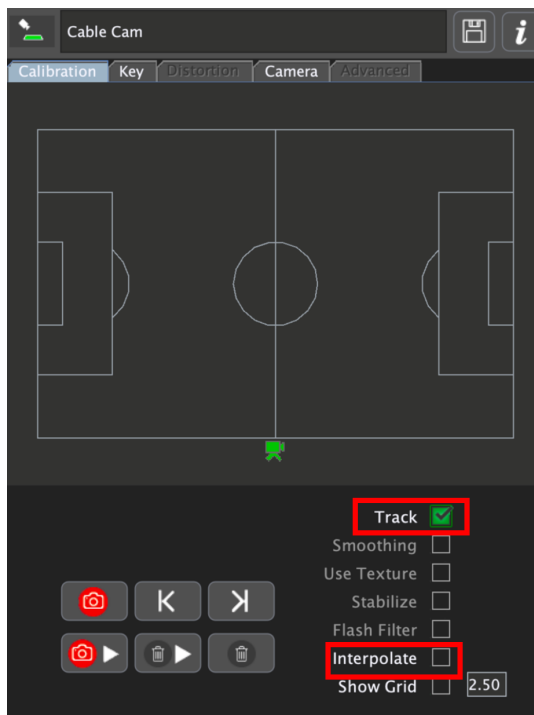

Calibration - Tracking Options

### Key Features

- The **Track** checkbox enables/disables **Texture Tracking**.
- The **Interpolate** checkbox enables/disables linear interpolation between **Record Points**.

# KLT Cable Cam

The **KLT Cable Cam Tracker** is a type of tracking similar to a texture tracker but optimized specifically for cable cam setups. It is designed to handle the unique requirements of overhead shots, offering a more tailored solution compared to standard line trackers. This tracker is fine-tuned for following the motion of objects in cable cam systems, ensuring smoother and more accurate tracking of objects in overhead or elevated perspectives.

Before starting the calibration for the **KLT Cable Cam Tracker**, it's crucial to provide accurate pitch dimensions. Unlike other tracking systems, where being approximately correct with the width and length of the pitch may suffice, the KLT tracker requires precise measurements.

★ **Important:** Make sure you have the following dimensions in advance of your show:

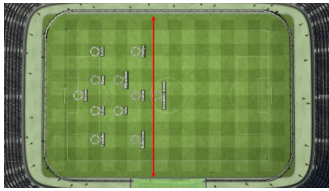

**Pitch Width** - refers to the measurement of the distance across the playing field or surface, taken from one side to the other. It defines the total width of the pitch.

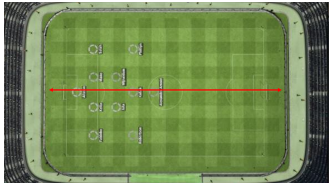

**Pitch Length** - is the measurement of the total distance along the longer side of a playing field or surface, from one end to the other. It defines the overall length of the pitch.



**Edge to Stands (m)** - refers to the measurement, in meters, of the distance between the edge of the pitch and the spectator stands.



**End to Stands (m)** - refers to the measurement, in meters, of the distance between the end of the pitch and the spectator stands.

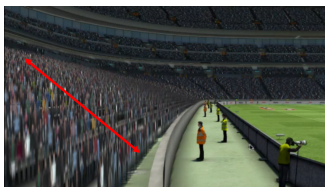

**Rake Angle (deg)** - refers to the angle at which the seating sections incline toward the field or playing area, measured in degrees.

**To perform a Cable Tracking calibration:**

1. In the **Effects Panel**, select the **Calibration Tool**.
2. In the **Parameter Panel**, in the **Calibration** tab, select **KLT Cable Cam**.
3. In the **Calibration** tab, update the following dimensions:
  - **Pitch Width**
  - **Pitch Length**
  - **Edge to Stands**
  - **End to Stands**
  - **Rake Angle**
4. Select **Next** and proceed to calibrate the pitch, making sure to use multiple points in your calibration.  
For information on calibrating using multiple points, see the [Matching the Model to the Image](#)<sup>45</sup> section.

# Live Tracker

The **Live Tracker** is a fast and flexible tracking solution designed for quick setup and short-term use in live broadcasts. Unlike more precise trackers that require extensive calibration for long-term use, the Live Tracker prioritizes speed.

For example, a camera operator sets up a shot, and the PIERO operator performs a quick calibration in just a few seconds. As the camera operator moves and adjusts to a new position, another rapid calibration can be performed for the next shot. This tracker allows for fast adjustments without requiring perfect calibration, since it's only used briefly before recalibrating. While it doesn't offer perfect tracking, it's ideal for scenarios where speed is essential and is optimized for dynamic, real-time events.

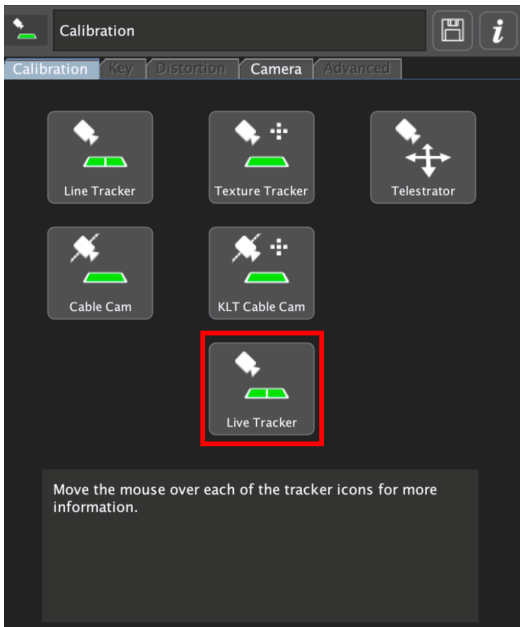

*Calibration Parameter Sheet - Live Tracker*

# Telestrator

The **Telestrator** calibration enables quick alignment of the calibration on a single frame of video. This is useful where other calibrations would not work, such as on very close camera shots.

## Key Features

- The **Track** checkbox enables/disables **Texture Tracking**.
- The **Interpolate** checkbox enables/disables linear interpolation between **Record Points**.
- The **Show Grid** checkbox enables/disables the grid as part of the calibration overlay.

## To perform a Telestrator calibration:

1. Add a **Pause** to the timeline on the frame you want to work on.
2. Add a calibration to the timeline.
3. Select the **Telestrator**.
4. Update the field, court, or rink dimensions.
5. When selecting the camera position, choose the one that is the nearest match to the direction in which the camera is pointing.
6. Use the mouse to position the **Telestrator** within the video window, adjusting it until the perspective and scale appear accurate.



## Tips

- Use **Show Grid** to add a grid to the calibration overlay. This helps when positioning the Telestrator and gives a guide of the perspective and scale you will achieve.
- Using the **Track** option: After positioning the Telestrator, add a **Record Point** and select the **Track** checkbox. The Telestrator will now track for a short duration.
- Using the **Interpolate** option: After positioning the Telestrator, add a **Record Point**. Move to another point in the video and position the Telestrator again. Add another **Record Point**. Now select the **Interpolate** checkbox. The Telestrator will interpolate between the two **Record Points**.

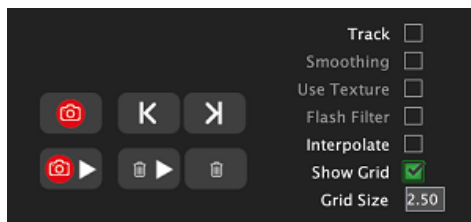

*Calibration - Tracking Options (Telestrator)*

- Positioning the Telestrator is like positioning a Virtual Camera.
  - Press the left mouse button and drag to rotate the overlay.
  - Press the middle mouse button and drag to move the overlay forward, backward, left or right.
  - Press the right mouse button and drag to change the camera distance
  - Use the scroll wheel to change the zoom level.

## Recording a Calibration

Once tracking is active, you can record the calibration, which means that it is aligned with the video for the duration of the recording. You will not need to press **Find** or add record points.

### To record a calibration:

1. Go to the point where you want to start recording the calibration and select the **FIND** button to ensure the calibration is aligned with the image.
2. Press the **Record Calibration** button.

The video will play.

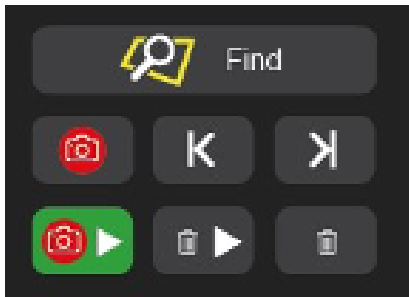

*Calibration - Record Calibration Button*

3. Press the **Record Calibration** button again to stop recording.

Where you have recorded the calibration, the timeline will be red.

## Record Points

Add **Record Points** on the timeline to record the position of the calibration on specific frames. **Record points** force the calibration back into alignment when the video plays through them. The most common way to use **Record Points** is to place one at the start of your action. After setting it, you can telestrate, review the playback, and then export.

### To add record points:

1. Go to the point where you want to add a **Record Point** and press the **FIND** button to ensure the calibration is aligned with the image.
2. Press the **Record Point** button to add a record point.

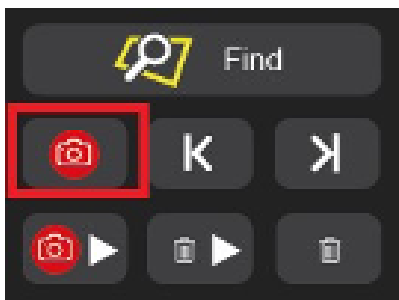

*Calibration - Record Point Button*

3. Repeat the process wherever you need to in the video.

 **Tips**

- If you are using **Record Points**, add them at the beginning of a graphics sequence and on every **Pause**.
- **Record Points** appear as red lines on the **Calibration** row of the timeline. You can select them to navigate to that point in the video.
- Remove **Record Points** by navigating to them and pressing the **Record Point** button again.
- Use the **Previous** and **Next** buttons to navigate between record points.

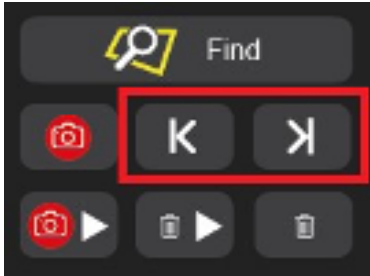

*Record Points Navigation Buttons*

Alternatively, you can press the comma or period key on the keyboard.

# Adding Effects

The selection and application of effects are tailored to the sport chosen in the Launcher. After selecting a sport, selecting an effect icon will add it to your project, where it can be customized for a specific still or sequence. Modifications can be made either through the effect property sheet or by interacting directly with the video window. The property sheet displays various effect parameters, such as color and transitions, allowing for precise adjustments.

To fully utilize the system's capabilities, it is recommended to complete keying and calibration before adding effects to your video clip. While not required for all effects, this process helps to optimize their performance. A detailed list of effects that necessitate keying and calibration is provided in the PIERO Effects section.



*Effect Property Sheet*

## To add/edit an effect:

1. Select an effect from the **Effects Panel**.

Each time you select an effect, a new instance will be added to the project. Take care not to double-click.

Some effects are added automatically to the clip while others are added to the project and need to be manually added to the clip.

2. In the effect's property sheet, edit the properties (color, transition, etc.) as necessary.
3. If you want to save the new property values as defaults, create a preset.

For details on creating a preset, refer to the [Creating Presets](#) <sup>71</sup> section.

For an in-depth description of each effect, see the [PIERO Effects](#) <sup>124</sup> section.

## To delete an effect:

1. In the **Timeline**, select the effect you want to delete.
2. Double-click the **Trash can** button at the bottom-left of the **Timeline**.

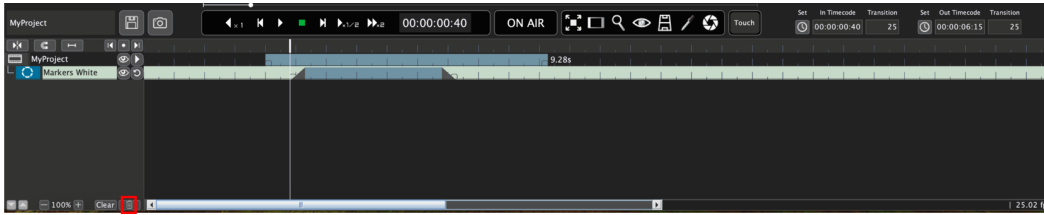

*Timeline - Delete Button*

Alternatively, you can delete an effect by using the **Delete** key.

The effect is deleted from the **Timeline**.

## To save an effect:

1. In your project, select the effect you want to save.
2. In the effect's property sheet, press the **Save** button (the  icon in the top right corner).

The new effect will appear in the **Files** panel in the list of saved effects and projects.

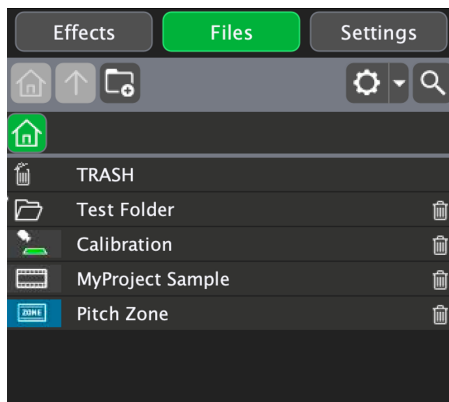

*Files Menu*

Additionally, you can use presets to create and save your own settings for effects. For additional information, see the [Presets](#) section.

## To load a saved effect into a project:

1. Select the **Files** tab.
2. Select the effect in the list you want to load.

The effect is added to the current project.

### To change the project:

1. Select the **Files** tab.
2. Select a project in the list.

The current project is replaced with the selected project.

### To delete a saved effect:

- Select the effect and then double-click on the trashcan to permanently delete the effect from the **Files** tab.

**OR**

- Right-click the effect and select **Delete** from the options menu.

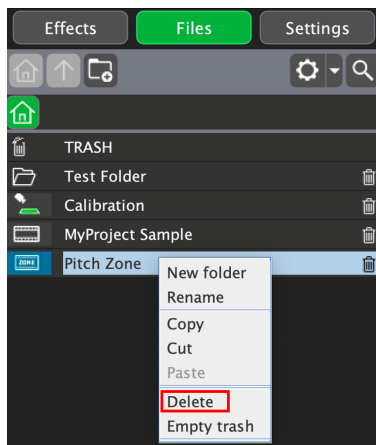

*Delete Effect*

## Presets

Presets allow you to create and save customized settings for effects, enabling quick access to your preferred configurations. You can create multiple presets for the same effect and switch between them as needed. Presets are specific to the sport and workflow mode (Analysis, Touch, Live) in which they were created.

### Preset Loading and Error Handling

In PIERO, presets are not all pre-loaded automatically; only the "default" preset is initially loaded. This "default" preset is different from the **Default** (effect name) option that appears when creating a preset. Here, "default" refers specifically to the most recently selected preset by the user.

The system performs error checks on this last-selected preset upon loading. When a new preset is selected, it checks for errors in real-time.

★ **Note:** It is not possible to validate all presets for errors simultaneously.

### Error Notification and Suggested Resolution

If an error is detected within a preset, a  **Warning** icon will appear, along with a tooltip prompting "*Please update presets.*" This indicates that users should update the preset via the preset selector located above the property sheet on the right. While updating may not resolve every issue, it is the recommended first step. If issues continue, users should contact [Ross Technical Support](#) for further assistance.

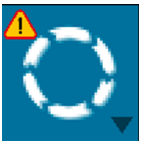

Marker Effect with Warning Icon

## Creating Presets

### To create a preset:

1. Select an effect.
2. In the effect's property sheet, change the settings as required.
3. Select the **Select Preset** drop-down.

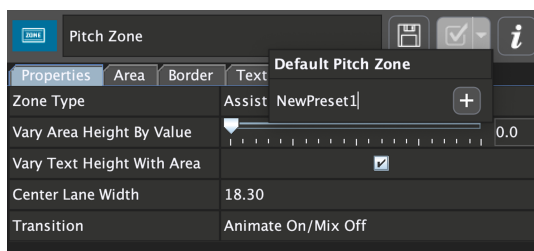

Create Preset

4. Enter a name for the preset and select the  **Add Preset** button to save it.

## To use a preset:

1. Select an effect.

The last-used preset for that effect becomes active.

2. In the effect property sheet, select the **Select Preset** drop-down.
3. Select the preset you want to use.

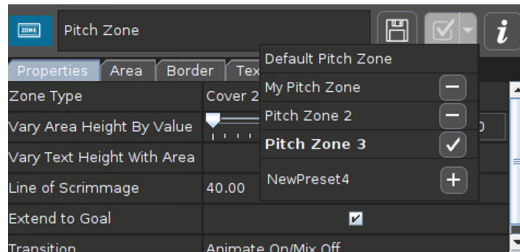

### Select Preset

Alternatively, you can right-click an effect in the Effects Panel and select the preset you want to use or revert to the default effect.

The last-used preset will be active whenever the effect is added to a timeline.

## To rename a preset:

1. In the effect's property sheet, select the **Select Preset** drop-down.

The last-used preset for that effect becomes active.

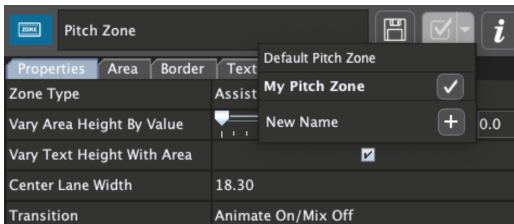

### Select drop-down

If you want to rename a different preset in the list, right-click an effect in the Effects Panel, then select the preset you want to rename.

2. In the bottom text box next to the **+ Add Preset** button, enter a new name.
3. Select the  **Check-mark** button.

The effect is renamed.

★ **Note:** This will also update the current preset with any property changes. To preserve the current preset settings, reselect the preset.

## To delete a preset:

1. In the effect's property sheet, select the **Select Preset** drop-down.

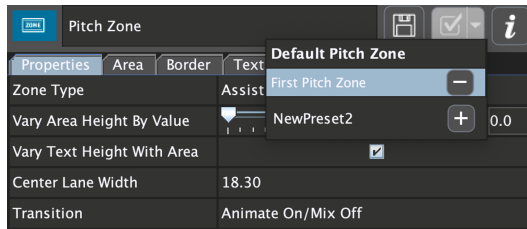

### *Parameter Panel - Preset Drop-Down*

2. Select the **Delete Preset** button next to the preset you want to delete.

The preset is deleted from the list.

# Additional Tools

The following tools are covered in this section:

[Region Tool](#)  75

[Hide Tool](#)  78

[Clip Tool](#)  79

[Pause Tool](#)  80

[XPression Control](#)  82

# Region Tool



The **Region Tool** is used to edit player regions to better segment them for effects such as Multicam, Moveable Players or Player Glow/Grow.

It is recommended to use the **Region Tool** with a [Keyer](#)<sup>321</sup>, although it is not mandatory.

The **Region Tool** can refine regions over several frames along the timeline, making it necessary to have only one instance in a project.

The following effects can take advantage of the refined segmentation:

- [Moveable Players](#)<sup>1821</sup>
- [Player Glow/Grow](#)<sup>1961</sup>
- [Virtual Players](#)<sup>771</sup> (on chalkboard or 3D Stadium)
- All effects that may need extra depth information, such as Laser Wall, Arrow (Height), etc.

## To use the Region Tool:

1. Add the **Region Tool** to the project.
2. In the property sheet, select the **Find Regions** button to perform an automatic recognition on the frame.
3. Move the mouse over a region and press **Delete** to remove the region.
4. In the property sheet, use the **Min Region Size** and **Max Region Size** sliders to define the smallest and largest regions the tool will detect.

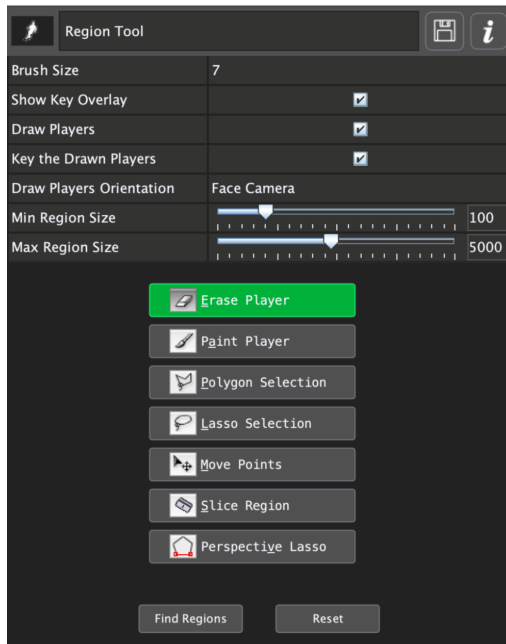

*Region Tool Property Sheet*

5. Use the following tools to refine the region:

Tool	Description
<b>Erase Player</b>	Erases parts of other players that may appear in the region (adds bits to the red key mask).
<b>Paint Player</b>	Adds missing player parts. Useful to force-draw a missing limb (removes bits from the red key mask).
<b>Polygon Selection</b>	Defines a custom region by drawing segments around a player. To complete a region, select the first initial point shown by a green rectangle.
<b>Lasso Selection</b>	Draws a free-hand region around a player. The region is closed when the mouse is released after dragging around the player.
<b>Move Points</b>	Moves the control handles that define a region.
<b>Slice Region</b>	Divides a region into 2 separate regions. Useful for separating 2 players.
<b>Perspective Lasso</b>	Polygonal lasso with perspective (used only with the Mutlicam effect). Start by the base line to set the perspective. When isolating a player and applying a perspective graphic the player may appear unnaturally thin. To correct this, utilize the perspective tool by first positioning the first line beneath the player's feet to define the perspective. Then, outline the remainder of the player accordingly.

## Segmenting Example

In the example below, the goalkeeper is not automatically recognized. Therefore, they will not appear as a virtual player, cannot be moved, and no graphics can be placed behind them.

There are two ways to bring the goal keeper in as a virtual player:

- Add key (red) to the image until they appear as a region.
- Add a region using either the polygon or lasso tools.



*Region Tool - Segmenting Example*

## Virtual Players

The **Region Tool** accurately draws and defines regions for virtual players in the 3D stadium. Displaying the virtual players is achieved by activating the **Show Players** property within the stadium's property sheet.



*Region Tool - Virtual Players*

## Raising an Arrow off the Ground

The **Region Tool** enables PIERO to elevate graphics off the ground, utilizing regions and depth information to accurately layer elements in 3D space. This functionality is particularly useful in sports like basketball, where precise rendering of visual elements enhances viewer experience. By segmenting players with this tool, PIERO ensures all graphics are correctly displayed.



*Region Tool - Raising an Arrow off the Ground*

In sports such as ice hockey, skiing, and basketball, the key often involves removing part of the athlete's appearance (such as skin color, white shorts, etc.). By clearing the **Key the Drawn Players** property checkbox, you can force PIERO to render the entire region without transparency. This technique depends on having very well-defined regions.

## Hide Tool

The **Hide Tool** is designed to seamlessly manage the visibility of graphics and effects during video transitions, particularly when detecting a cut in the video. The tool's detection is based on changes in key signals and loss of reliability in tracking.

By enabling the Hide tool, PIERO will temporarily stop outputting graphics for the duration of the hide period set in the timeline. This ensures that when going **ON AIR**, the graphics will disappear for the specified time and automatically reappear afterward.

This feature is especially useful in scenarios such as when an advertisement appears on the screen, or during camera position transitions, allowing users to maintain a clean output without unwanted graphics during those moments.



*Effects Menu - Hide Tool*

### To add the Hide Tool:

1. Pause the video at the specific frame where you intend to apply the **Hide Tool**.
2. In the **Effects Panel**, select the  **Hide Tool** button.
3. The **Hide Tool** appears in the Timeline.

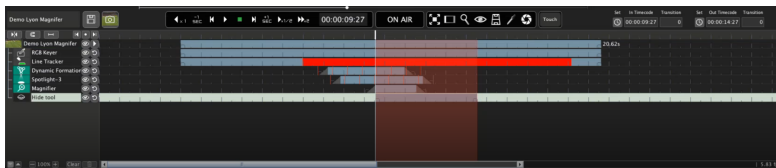

*Timeline - Hide Tool*

4. Adjust the Hide Tool's duration by extending it along the timeline to the desired length.

The **Hide Tool** is enabled and PIERO will temporarily stop outputting graphics for the duration of the hide period set in the timeline.

# Clip Tool

The **Clip Tool** is a versatile feature designed to help users create defined segments directly within a video file along the timeline. This tool allows for precise control over each clip, enabling users to apply separate calibrations, keys, and effects to individual segments. When it comes to exporting, the tool provides flexibility—users can choose to export clips individually or collapse the timeline to export all clips collectively, thereby eliminating any content outside the selected clips.

Additionally, clips can be bundled with associated graphics and other assets. However, note that graphics cannot extend beyond the length of the associated clip on the timeline.



*Clip Tool*

## To add a clip:

- In the **Effects Panel**, select the  **Clip Tool** button.

The **Clip Tool** is added to the Timeline.

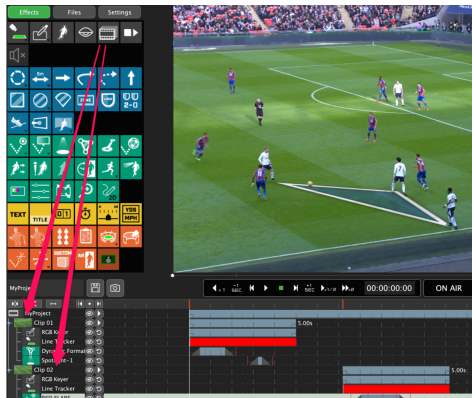

*Timeline - Clips Tool*

## Pause Control

The **Pause** tool has been designed to allow control of the video playback hardware device connected to PIERO (e.g., EVS LSM, Sony digibeta, Local Clip, Blackmagic Hyperdeck). The video device can be automatically paused and played back from any point on the timeline.

★ The **Pause** tool behavior is only active in **ON AIR** or **TOUCH** mode (not **LIVE** mode).

Adding a **Pause** tool to the timeline pauses the video at the current timecode. The pause point appears as a red line in the time meter, and the video source is paused for the duration of the **Pause** tool on the timeline. By default, the video will be set to pause at this point for 5 seconds and then play on. To extend the duration of the **Pause**, drag the end of the timebar.





### Pause Tool

When the video device is paused, the timecode doesn't change (it's only paused). Effects within the pause will have the same **In Timecode** of the effect, but will be triggered by the delay property. The delay is specified in frames from the **In Timecode** of the effect. This is handled automatically when dragging timebars on the user interface.

Property	Description
<b>Duration</b>	Allows the duration of the pause to be preset.
<b>Out Action</b>	The action the connected VTR device should perform at the OUT point. Default is Play.
<b>Mid Action (LSM ID)</b>	Loads an EVS LSM clip at the Mid Point. The LSM clip should be specified as 3 digits and 1 letter, e.g. 123A.
<b>Mid Point</b>	This is the point in the pause when the load clip command is sent to the EVS.

## Troubleshooting

A common problem when using the Pause tool is that the video doesn't stop on exactly the correct timecode frame.

Problem	Description	Solution
<b>The video device stops too early.</b>	When this occurs, PIERO automatically jumps to the correct timecode of the <b>Pause</b> tool, causing jitter in the video. PIERO is forced to do this to ensure all effects within the Pause duration are triggered correctly.	In the <b>Pause</b> tool property sheet, reduce the <b>Response Time</b> . Use the <a href="#">Response Time Procedure</a>  to find exactly what the response time should be.
<b>The video device stops too late.</b>	When this occurs, the timebar line will appear after the <b>Pause</b> duration and not traverse through the red pause area. However, effects within the <b>Pause</b> duration will still be triggered as expected.	In the <b>Pause</b> tool property sheet, increase the <b>Response Time</b> . Use the <a href="#">Response Time Procedure</a>  to find exactly what the response time should be.

## Response Time Procedure

The **Response Time** is the duration of time (in fields) to send the command to the video player in advance. This is to compensate for the delay that occurs between sending the instruction to the video player and the player taking action. The correct value for the Response Time parameter can be found by following this procedure.

### To find the correct Response Time:

1. Create a **Pause** tool at the desired timecode, for example 10:00:00:00.
2. Set the **Response Time** parameter temporarily to zero.
3. Set PIERO to **ON AIR** mode and play the video device to the VTR effect pause point.

You will notice the VTR will play past the desired timecode and will pause too late at something like 10:00:00:05. The five frames difference is the time for the video device to react to the pause command, caused by delays inherent in the video device.

The **Response Time** can be calculated as double this difference (in this example it is therefore 10).

It is double because the **Response Time** is measured in fields for fine control over this delay.

4. Enter the **VTR Response Time** into the **PIERO Global Settings** UI for later use.

## PIERO Touch Pause

When using the **Pause** tool with a touch screen or iPad the presenter may want to speak indefinitely, then press **Play** to resume the action.

To achieve this, select the **Make Touch Pause** checkbox.

## XPression Control

The XPression Control tool in PIERO enables interaction with XPression, a powerful graphics solution by Ross Video, using RossTalk commands. This integration allows users to trigger graphics in XPression directly from PIERO, enhancing live sports broadcasting by automating graphics playback in sync with key events in the PIERO timeline. It is important to note that this tool is only operable when PIERO is set to **Live** mode.



Effects Panel - XPression Control Tool

## Connecting PIERO to XPression

Before you begin using the XPression Control tool, ensure that both PIERO and XPression systems are correctly configured to communicate. This involves not only establishing a connection via RossTalk but also ensuring that XPression is running with the relevant project opened. This section guides you through the connection process to prepare your PIERO system for interaction with XPression.

**Note:** Knowledge of XPression and RossTalk is a prerequisite, as this section does not cover how to configure or use these systems. Within the PIERO user interface, the **i Help** icon provides brief descriptions of available RossTalk Control commands, serving as a quick reference guide. However, this does not substitute for a full understanding of how to use these commands. For detailed information on XPression, refer to the *XPression User Guide*. For more on RossTalk commands, consult the *RossTalk / Smart GPI On XPression* document.

### To connect PIERO to XPression:

1. Ensure that XPression is running and that the relevant project is open.  
This project should contain the scenes you plan to trigger from PIERO.
2. Obtain the IP address for the XPression system and note the port number used for RossTalk.
3. In PIERO (Live mode), go to the **Settings** menu and select the **Live** tab.
4. In the **Live** tab, locate the **RossTalk Settings** section.

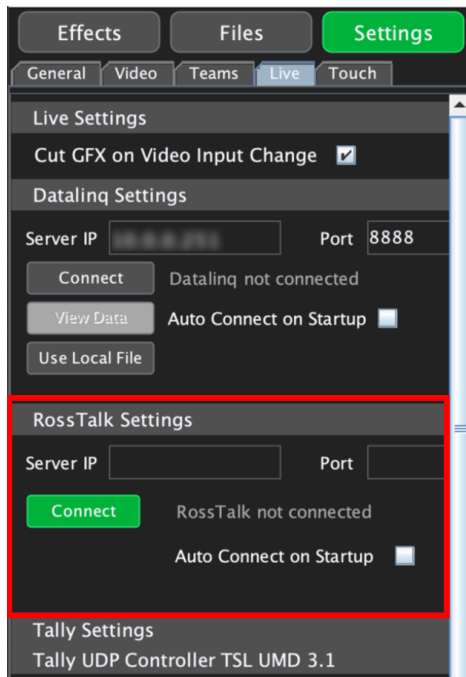

*Live Tab - RossTalk Settings*

5. In the **Server IP** field, enter the IP address of the XPression system.
6. In the **Port** field, enter the port number designated for RossTalk communication on the XPression system.
7. Select the **Connect** button to connect to the XPression system.  
If the connection is successful, PIERO will be able to send RossTalk commands to XPression.
8. Optionally, check the **Auto Connect on Startup** box to ensure that PIERO automatically reconnects to XPression each time it starts.

## Using the XPression Control Tool

Once you have established a connection between PIERO and XPression, you can use the XPression Control to trigger graphics directly from the PIERO timeline.

### To use the XPression Control tool:

1. In PIERO, go to the **Effects** menu and select the **XPression Control** tool.
2. In the parameter sheet, locate the **Animate ON command** section.
3. From the **RossTalk Command** dropdown menu, select the command that initiates the desired action in XPression.

The settings available in the UI will change based on the command selected, reflecting the specifics required for that command.

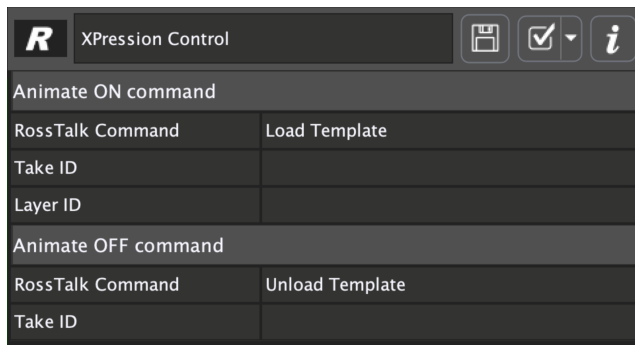

*XPression Control Parameter Sheet*

4. Locate the **Animate OFF command** section and from the **RossTalk command** dropdown menu, select the appropriate RossTalk command for removing the XPression scene.

The UI will update to display settings relevant to the selected command.

5. In the Timeline control bar, select the **ON AIR** button.
6. In the **Effect Group**, select the **Animate** button to trigger the selected **Animate ON command**.

The RossTalk command is sent to XPression and the specified XPression scene is displayed on the broadcast feed.



*Effect Group - Animate Button*

7. To remove the XPression scene, select the **Animate** button again, which triggers the selected **Animate OFF command**.

# Previewing Final Output

While setting up your project, you may want to preview the video to see what the final playout will look like. In the **Timeline** you can access the **ON AIR** button, which enables you to view what the final output will look like live, by hiding onscreen controls.

When the **ON AIR** button is not selected, any graphic you have selected in the **Timeline** will always show in the video.

## To view a final output:

- In the **Timeline**, select the **ON AIR** button.

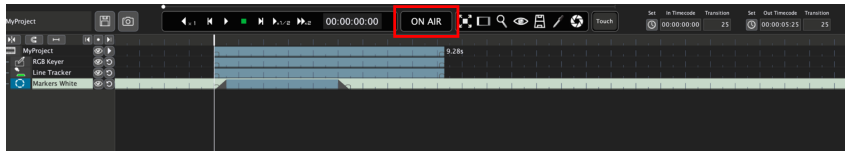

*Timeline - ON AIR Button*

The on-screen controls are hidden in the video and the video plays out in the **Video Viewer**.

# Exporting to a Video File

This section covers the process of exporting videos, including instructions for exporting an entire project to a video file, a single video clip, multiple clips, and details on the supported video formats.

## To export the entire project to a video file:

1. In the **Timeline**, select the project. The default name is **MyProject**.

The source video's export settings are displayed in the **Parameter** panel.

2. In the **Parameter** panel, select the  **Folder Directory** button.

The File Explorer opens.

3. Navigate to the location you want to save the video and select the **Select** button.

The File Explorer closes.

4. In the **Filename** field, enter a name for the video file.

5. From the **Format** drop-down, select the video format you want.

★ **Note: H264 [AAC stereo(s), 16b 48kHz] in MPEG-4 as mov** is good option for compressed video.

Additionally, different file formats are licensed separately, depending on the PIERO edition you are licensed to use.

6. Select the  **Export** button.

The project is exported and saved to the destination you specified.

If no destination is specified for exporting the video file, it will be automatically saved to the default location:

**home/PIERO/Clips/PIEROExport/**

## To export using the Clip tool:

1. Use the  **Clip** tool to define the start and end point of the sub-sequence/clip.

2. Next, perform your PIERO analysis.

3. To export only the clip, select the **Clip** tool in the **Timeline**.

4. Then select the **Export** button in the clip's property sheet.

The clip is exported and saved to the destination you specified.

## To export multiple clips back-to-back in one video:

1. In the **Project** panel, select the  **Collapse Timeline** button.

When collapsed, the clips will appear next to each other, no matter where they were created on the main video.

2. Select the **Project** row at the top of the **Project** panel and select **Export** in the property sheet.

The clips are exported as one video and saved to the destination you specified.

## Video Formats

Select the resolution of the video you want to use.

Supported formats are:

- 480i 29.97Hz (NTSC 16:9 and 4:3)
- 576i 25Hz (PAL 16:9 and 4:3)
- 720p 50Hz
- 720p 59.94Hz
- 1080i 50Hz
- 1080i 59.94Hz
- 1080p 50Hz
- 1080p 59.94Hz
- 2160p 50Hz
- 2160p 59.94Hz

## File Codecs

When decoding files, some codecs are not included with PIERO by default. If a video uses an unlicensed codec, a MainConcept logo appears in the top left corner of the video. To arrange an additional license, contact Ross Support.

The following codecs are included by default:

- AVC/H.264
- MPEG-1/2
- H.263

The following codecs require additional licenses:

- DVCPRO-HD
- H.265
- Avid DNxHD
- Apple ProRes
- JPEG 2000

For more information about supported codecs and file extensions, see the *PIERO Tech Guide*.

# PIERO Touch

PIERO Touch allows users to customize a touchscreen interface to meet their specific needs. The interface is adaptable to both large and small screens and can integrate multiple devices simultaneously, providing support for multiple presenters. A reliable network connection between the Touch computer and the PIERO machine significantly enhances the user experience, ensuring optimal performance.

The PIERO Touch user interface is specifically engineered for touchscreens, streamlining the addition of graphics to video footage. This feature enables commentators and presenters to create effect sequences directly on the video image with ease and precision, by using the touchscreen.

For detailed information on PIERO Touch for Windows, please refer to the *PIERO Tech Guide*.

## Broadcast User Interface - Touch Mode

The Touch mode user interface is designed to streamline the creation and application of Touch effects in PIERO, functioning independently from the Analysis mode. Touch effect presets are separate from Analysis effect presets and are displayed differently in the effect palette. Each Touch effect includes a required "default" version, which is always present, alongside any additional presets. Hovering the mouse over an icon reveals the name of the preset or identifies it as the "default" effect.

The list of Touch effects available in PIERO matches the effects listed in the **Buttons** tab of PIERO Touch. This alignment ensures consistency between the Touch mode interface and the configuration options available in the PIERO Touch **Control Panel**, allowing for efficient selection and management of effects.

### To enable the Touch mode UI in PIERO:

- Within your PIERO project, in the **Timeline Control Bar**, select the **Touch** button.

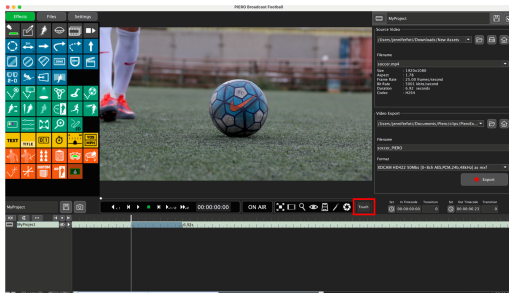

*PIERO Project - Touch Button*

The user interfaces switches to **Touch** mode.

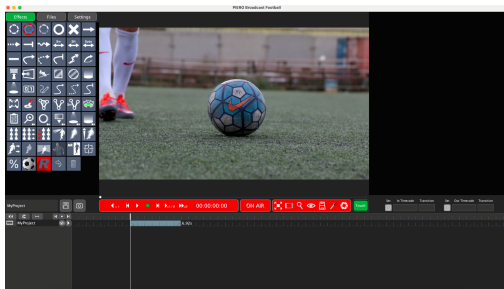

*Broadcast Edition - Touch Mode UI*

**To return to the Analysis mode:**

- In the **Timeline Control Bar**, select the **Touch** button.

The user interface returns to the Analysis mode.

## Touch User Interface Overview

This section provides an overview of the PIERO Touch user interface on a remote device. The interface offers flexible customization options, allowing presenters to tailor the appearance and functionality to meet their specific needs, ensuring all telestration tools are readily accessible.

See the *PIERO Tech Guide* for more in depth information about the PIERO Touch application for Windows.



*PIERO Touch User Interface Shown on a Remote Device*

## PIERO Touch - Effects Panel

The available effects are those that would be useful for a presenter. Tools such as the **Calibration** and the **RGB Keyer** are not intended for the presenter, and are therefore excluded from the PIERO Touch interface.

### To customize the Effects Panel:

1. Select the **Edit Mode** check-box at the bottom-left of the PIERO Touch screen to customize the ordering and layout of the effects.



*Touch Presenter - Control Panel Check-box*

Alternatively, you can use the keyboard shortcut **CTRL+E** to enter **Edit** mode, and pressing **CTRL+E** again will exit Edit mode.

The **Piero Touch Control Panel** window opens.

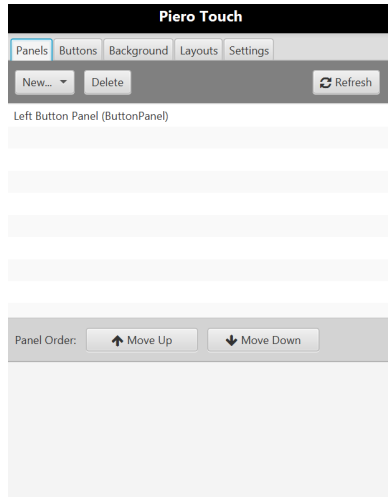

*Piero Touch Control Panel*

2. Select the **Buttons** tab.



*Piero Touch Control Panel - Buttons Tab*

The **Buttons** tab lists all of the available Touch effects from the PIERO project along with VTR control buttons. In this tab, you can create your own icon set to customize the buttons.

3. Drag effects from the **Effects Palette** and drop them onto a **Button Panel** in the PIERO Touch layout.

The available **Button Panels** are listed in the **Panels** tab of PIERO Touch, allowing you to organize effects according to your layout preferences.

★ For more in depth information on the **Buttons** tab, see the *PIERO Tech Guide*.

## To add team colors to effects buttons:

1. Within your PIERO project, in the **Effects Panel**, select the **Settings** menu.

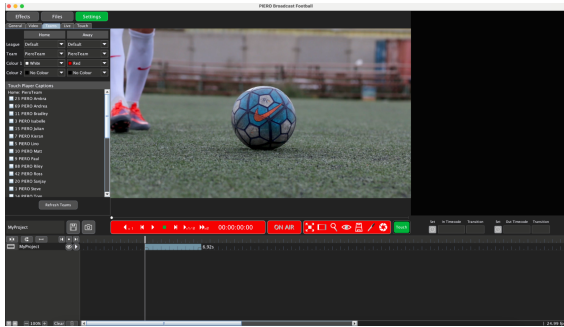

*Settings Menu - Teams Tab*

2. In the **Settings** menu, select the **Teams** tab and configure the color settings to match your team colors.  
Only Touch effect presets created with "home" or "away" as their color choice are automatically updated in the PIERO Touch UI to match the selected team colors.

## To undo last action in PIERO Touch:

- In the **Effects Panel**, select the  **Undo** button to undo the last action performed in PIERO Touch.

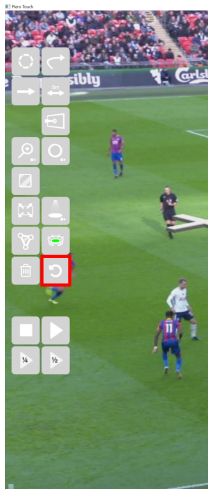

*Effects Panel - Undo Button*

## To delete effects:

- Select the trashcan button to fade off all effects and delete them from the project except for the following:
  - Calibration and RGB Keyer
  - Effects added to the timeline by the operator (analysis mode)
- ★ The **Trash effects automatically** option in the PIERO Touch **Settings** panel can automatically delete effects when the video starts playing, streamlining the process of clearing effects during playback.

## PIERO Touch - Clips

The **Piero Clip Panel** displays thumbnails for navigating between clips within the current PIERO stack in your PIERO project. Any clips included in the PIERO project's timeline will be shown in the PIERO Touch **Piero Clip Panel**. This panel is configured in the **Panels** tab of the **Piero Touch Control Panel**.

The PIERO Touch interface also includes the **Piero Stack Panel**, which lets you load different PIERO projects by selecting their thumbnails. Additionally, the **Stack Name Settings** in the **Settings** panel offers customization options for the **Piero Stack Panel**. It can be set to display only stacks with a specific suffix (e.g., "Touch") and to remove a defined number of characters from the start of stack names. This feature is particularly useful for customers who include identifiers, such as EVS clip IDs, at the beginning of their stack names, ensuring a cleaner and more intuitive stack display.



*Clip Panel*

### To navigate to the beginning of a clip:



- Select a clip icon to navigate directly to the beginning of the clip.

# PIERO Remote iPad Application

PIERO Remote for iPad enables control of video playback, live on-air 3D graphics, and the retrieval of predefined stacks and clips directly from the iPad.

Before you begin, ensure that the iPad is connected to the same local network as the PIERO machine and that the PIERO Remote iPad application has been installed on the device. The PIERO Remote iPad application, named **Piero Remote 2**, can be downloaded from the Apple App Store.

This section covers the following topics:

- [Starting the PIERO Remote iPad Application](#)  95
- [PIERO Remote iPad Application User Interface](#)  97

## Starting the PIERO Remote iPad Application

Follow the instructions below to start the iPad application.

### To start the iPad application:

1. Connect the iPad to the correct WiFi network.
2. Start the **iPad PIERO Remote** app on the iPad.

You will see the following screen on the iPad, indicating that the application is not yet connected to PIERO.

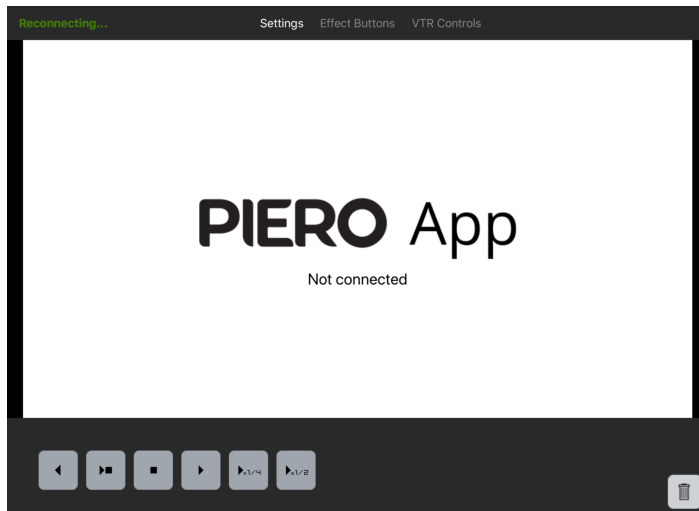

*PIERO Remote iPad Application - Not Connected*

3. Press the **Settings** button at the top of the UI.
4. In the Piero server IP address field, enter the PIERO workstation IP address.

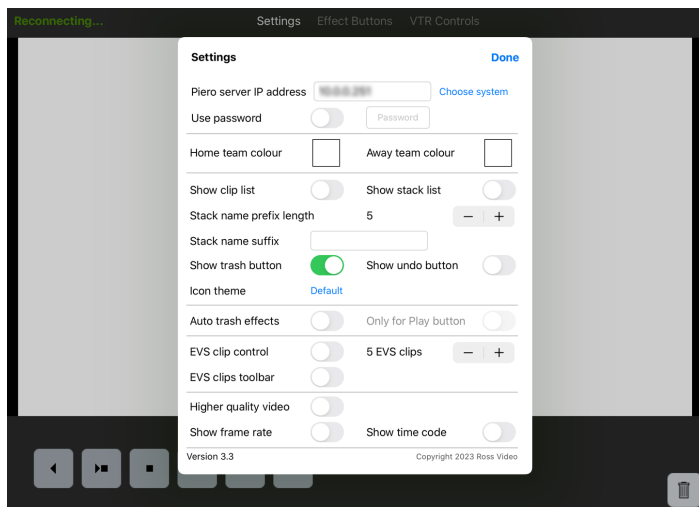

*PIERO Remote Settings - PIERO Server IP Address*

The PIERO server IP address can be found in your PIERO project, located in **Settings>Touch**, in the **Available Network Interfaces** section.

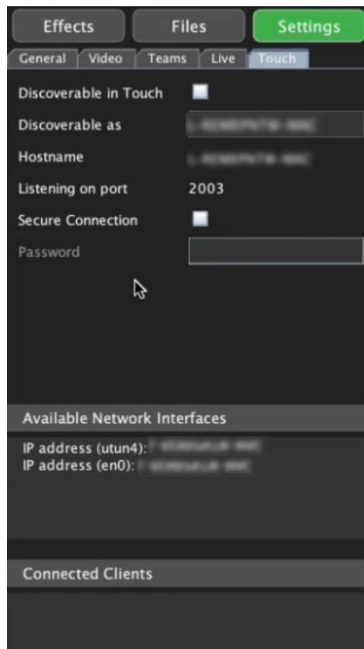

*PIERO Settings - Touch Tab*

★ **Note:** The **Choose System** button in the **Settings** panel can be used to select the PIERO system if it is discoverable on the network, saving the user from having to manually enter the IP address.

5. Press the **Connect** button on the iPad.

If the iPad is able to successfully connect to PIERO, the video output will be visible on the iPad. In addition, the **Remote** tab should indicate that the iPad has connected.

If the connection is not successful, please check the network settings and test network connectivity. If problems persist, have a look at the *PIERO Tech Guide*, then contact [techsupport@rossvideo.com](mailto:techsupport@rossvideo.com).

Once the PIERO Remote iPad application is successfully connected to the PIERO PC, the video output will be displayed on the iPad screen, as shown below.

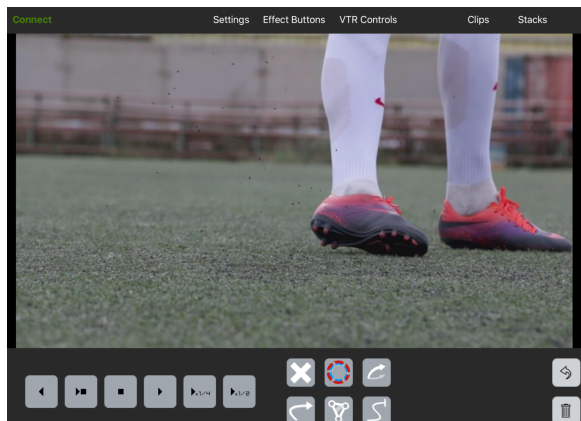

*PIERO Remote iPad Application - Connected*

# PIERO Remote iPad Application User Interface

The Remote iPad Application user interface is described in this section.

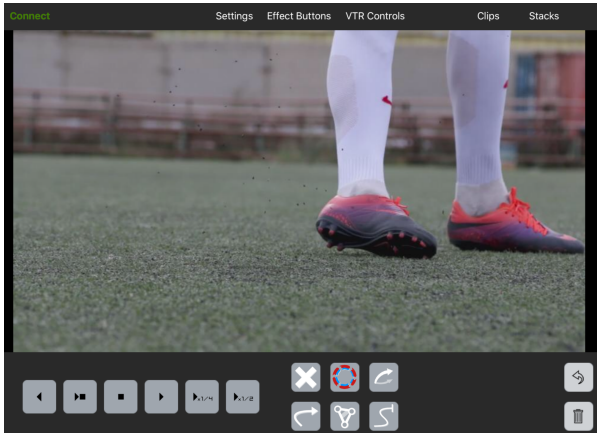

PIERO Remote iPad Application - User Interface

## PIERO Video Viewer

At the center of the user interface is the PIERO video viewer, which displays the output generated by the PIERO workstation. The quality of the image and the frame rate are dependent upon the WiFi connection's speed and reliability, as well as the video's playback status. While the image on the iPad may not match the SDI video output from the PIERO workstation in terms of quality, it is designed to be adequate for the precise placement of analysis graphics.

## Connect button

The **Connect** button connects the iPad to the PIERO workstation specified in the **Settings** menu. If you experience video playback issues or encounter other problems, selecting the **Connect** button will allow you to disconnect and reconnect to the PIERO workstation, potentially resolving the issue.

## Settings menu

The **Settings** menu enables you to specify the IP address of the PIERO workstation you intend to connect to. Additionally, the **Settings** menu allows you to select two team colors for the colored effects, such as **Markers** and **Arrows**. You can also configure various interface options, including the display of the **Clips**, **Stack**, **Undo**, and **Trash** buttons, among other customizable settings.

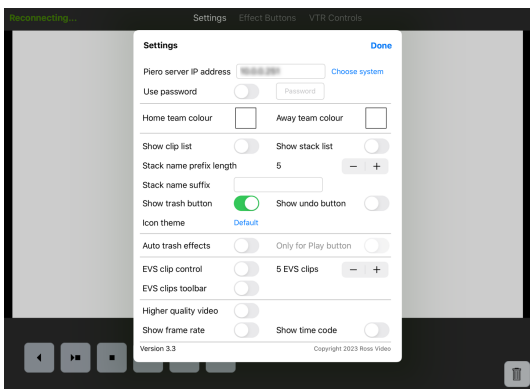

Settings Menu

## VTR controls

The **VTR Controls** replicate the controls on the PIERO main screen. If PIERO is currently playing a clip, the video may stop playing at the end of the clip, depending on whether the clip has been configured to halt at its conclusion.

The **VTR Controls** can be edited within the **VTR Controls** menu.

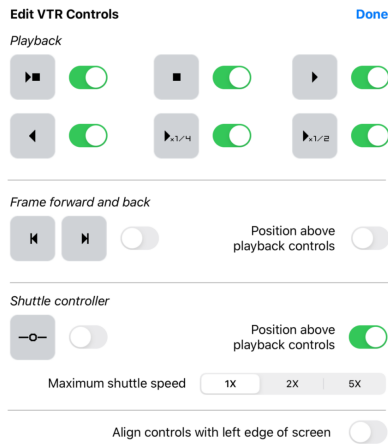

### Edit VTR Controls Panel

## PIERO effects

There are several buttons available for adding effects, which are designed to be used when the video is paused on a still frame. These effects function similarly to the touchscreen buttons in **Touch** mode. For more detailed information on using **Touch** mode, refer to the [PIERO Touch](#) section, as much of the information is also applicable to the iPad.

★ Ensure that PIERO is set to **Touch** mode before attempting to add any effects.

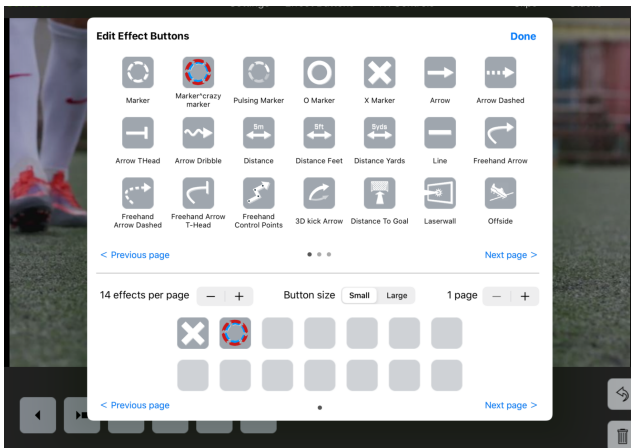

### Effects Buttons Menu

### To add PIERO effects:

1. Pause the playback.
2. Then select an effect button to add a new copy of the effect to the current project.  
The effect button will be highlighted with a green border, to indicate it was the last button pressed.
3. Touch in the video viewer to draw the effect.  
The effect is displayed in the video viewer.

### To undo the last action:

- Select the **Undo** button to undo the last action within the most recently added effect.
- ★ The **Undo** button is visible in the UI only if its display is enabled in the **Settings** menu.

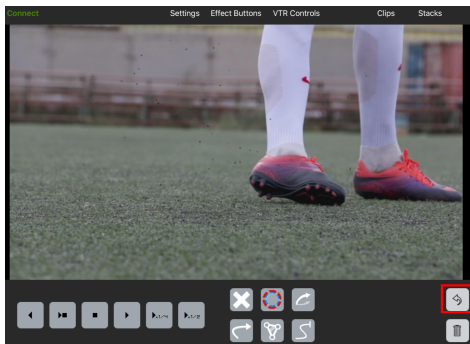

*Undo Button*

The effect disappears from the video viewer.

### To delete all effects:

The **Trashcan** button will remove all the effects added by the iPad. Effects that were already in the project are not deleted. For example, you can keep a **Calibration** and an **RGB Keyer** effect in the project, and these cannot be accidentally deleted from the iPad.

★ The **Trashcan** button is visible in the UI only if its display is enabled in the **Settings** menu.

- Select the **Trashcan** button to remove all effects added by the iPad.

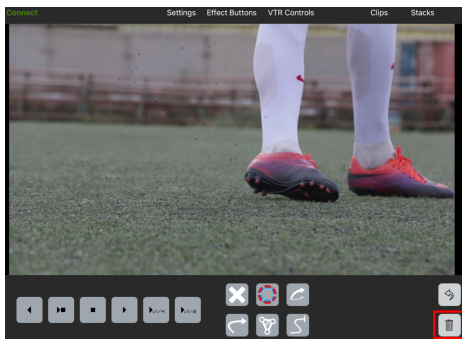

*Trashcan Button*

The effects disappear from the video viewer.

## Clips Menu

The **Clips** menu lists all the clips in the current project. Selecting one of these will move the video to the start of the clip, ready for playback.

★ The **Clips** menu is visible in the UI only if its display is enabled in the **Settings** menu.

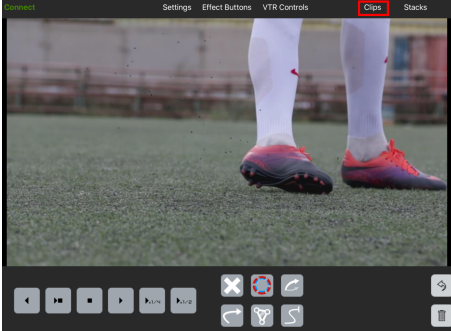

### Clips Menu

## Stacks Menu

The **Stacks** menu lists all the available saved projects in PIERO. Selecting one of these will load the project.

★ The **Stacks** menu is visible in the UI only if its display is enabled in the **Settings** menu.

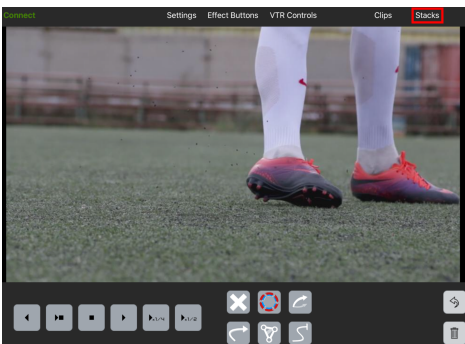

### Stacks Menu

# NDI® Input/Output

Network Device Interface, or NDI, enables communication and identification between multiple video systems over IP networks. It supports the encoding, transmission, and reception of numerous streams of high-quality, low-latency, and frame-accurate video in real time.

The **NDI Input/Output** and **NDI Preview** options located in the Launcher allow users to bring NDI video sources into and out of PIERO. **NDI Preview** provides an additional copy of the video output over NDI, which does not impact the main outputs, including SDI outputs. This setup provides flexibility for monitoring or distributing video feeds without impacting primary video outputs.

## To set up NDI for Input and/or Output:

1. In the Launcher, ensure that the following parameters are configured:

- a. **Mode:** select a mode (**Live** or **Broadcast**).
- b. **Sport:** select the sport for which you want to create a project.
- c. **Video Input:** select **NDI In** or **NDI with Alpha**.

The selection between **NDI In** and **NDI In with Alpha** depends on whether the NDI source includes an alpha channel. Choose **NDI In** if the NDI source does not have an alpha channel; choose **NDI In with alpha** if it does. PIERO supports only progressive NDI sources with alpha channels; interlaced NDI sources with alpha channels are not supported.

★ **Note:** You can configure more than one of PIERO's video inputs as NDI sources. Once you've selected these inputs in the Launcher and launched PIERO, a drop-down menu for each configured NDI input will be displayed in the **Video** tab within the **Settings** panel.

d. **Video Output:**

It is possible to use NDI for the main PIERO output by selecting **NDI Out** under **Video Output 1** in the Launcher. This output will then be available on the network as an NDI source labelled **PIERO Output**.

e. **NDI Preview:** select **Off**.

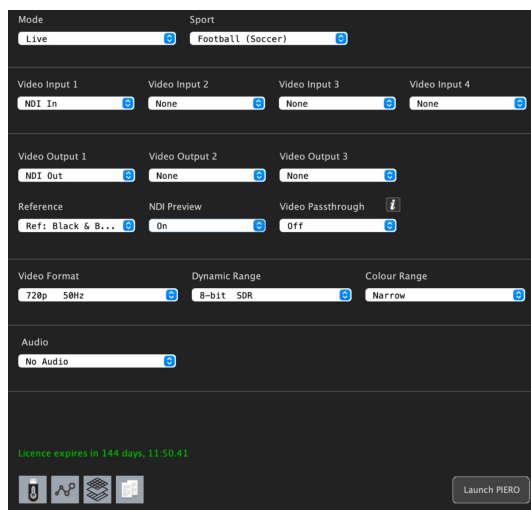

*Launcher - NDI Settings*

2. Once the parameters are configured, select **Launch PIERO**.

PIERO opens.

3. In the **Effects Panel**, select the **Settings** menu.

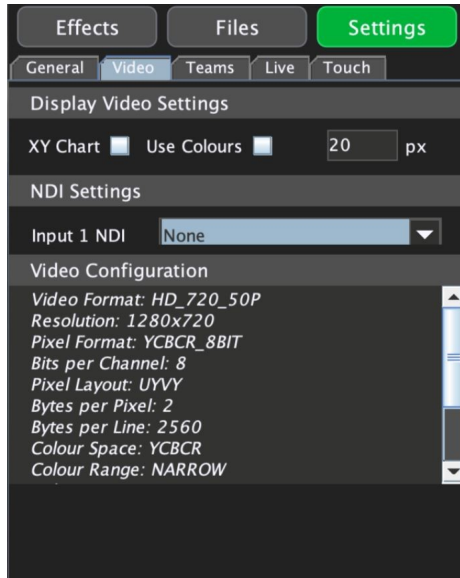

*Effects Panel - Settings*

4. Select the **Video** tab.

5. In the **NDI Settings** Section, use the **Input 1 NDI** drop-down to select the input you want.

The video stream is now coming into PIERO and is displayed in the **Video Viewer**.

## Setting up NDI Preview

NDI Preview provides an NDI copy of the main PIERO video output, available on the network as an NDI source named **PIERO Output**.

### To enable NDI Preview:

- Set **NDI Preview** to **On** in the Launcher.

No additional Launcher configuration is required, as NDI Preview is supported in all PIERO configurations.

## Important Information on NDI Sources and Usage in PIERO

- The video resolution (width and height) of NDI sources must match the **Video Format** selected in the Launcher.
- Audio in NDI sources is not supported by PIERO.
- PIERO supports only 8-bit SDR (standard dynamic range) NDI sources; 10-bit HDR (high dynamic range) NDI sources are not supported.
- Only NDI sources on the same subnet as PIERO appear in the **Video Settings** drop-downs. To connect to NDI sources on different networks, contact [Ross Video Technical Support](#) for configuration assistance.
- The name of the PIERO NDI output is fixed as **PIERO Output** and cannot be changed.
- Known issue: Selecting NDI sources in the **Video Settings** panel may not immediately take effect. Restarting PIERO generally establishes a successful connection with the chosen source.

# PIERO Plugin for Voyager

PIERO and Voyager products work together to produce Virtual Reality (VR) or Augmented Reality (AR) studio outputs for sports analysis. PIERO manages the data content and handles touchscreen or iPad interactions, while Voyager is responsible for visualizing the pitch within the VR or AR studio environment. The PIERO Plugin for Voyager/Unreal acts as a bridge between the two systems, ensuring that their respective graphics and operations remain synchronized.

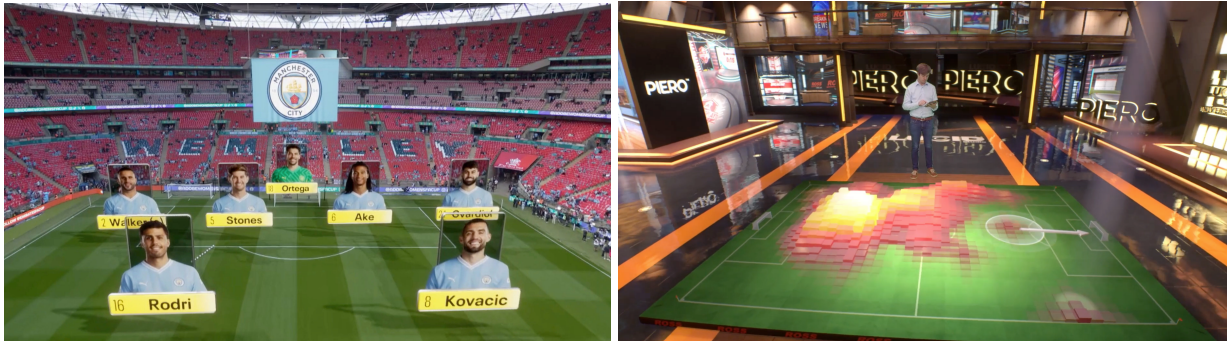

PIERO - Voyager

## Hardware Prerequisites

The table below lists the hardware components required to use PIERO within Voyager:

Hardware Component	Description
Touchscreen Display	Enables touch interaction. Alternatively, the iPad PIERO application may be used.
PIERO Touch	Runs the PIERO Touch app on an iPad or Windows PC.
PIERO PC	Interfaces with the PIERO Touch Client and Voyager PC.
Voyager PC	Renders the VR/AR studio. The PIERO Unreal plugin is required to interface with PIERO.

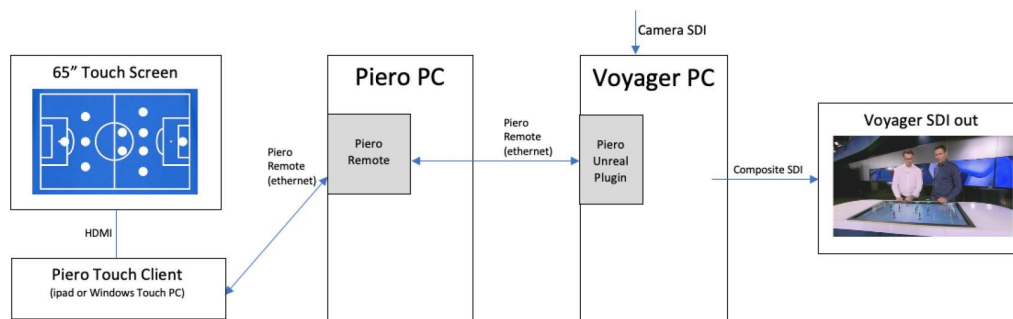

### Hardware Schematic

Connect each of these devices to the same network and ensure SDI reference locking to minimize delays.

★ **Note:** Wi-fi use is not recommended as it causes latency and touchscreen lag.

# PIERO - Voyager Workflow

The PIERO/Voyager workflow requires the PIERO Touch application to drive the narrative. The PIERO Touch application opens individual PIERO projects through project load touch buttons. Once a project is loaded, PIERO automatically sends the selected project's effects to the Voyager plugin. The touch-screen user can then load and visualize multiple PIERO projects, controlling the content on the sports pitch or field in Voyager. Additionally, groups or clips in PIERO enable users to animate multiple effects on or off.



PIERO Football Team Line Up



Voyager/Unreal Team Line Up

## PIERO Workflow

PIERO Live UI mode is recommended for use with the Voyager plugin.

### To access PIERO Live UI mode:

1. In the Launcher, from the **Mode** drop-down, select **Live**.
2. Launch PIERO.  
The PIERO application opens.
3. In the **Timeline Control Bar**, select the **Touch** button.



Timeline Control Bar - Touch Button

**Touch** mode is activated.



*Live Edition User Interface - Touch Mode Activated*

4. Connect the touchscreen (or iPad) to PIERO using the PIERO Touch application, which is available for Windows and iOS.

For additional information on setting up PIERO Touch, see the [PIERO Remote Touch](#) section.

Users of PIERO Touch often draw on a blank sports pitch or field from an overhead view. Therefore, it is recommended to add a PIERO virtual stadium effect to an empty PIERO project, along with a virtual camera effect set to an overhead angle, as shown in the screenshot above. Pre-defined PIERO groups, such as team lineups or Opta statistics, can then be added to the project using the Live mode UI, and animated on or off as needed.

See the *PIERO Live User Guide* for additional information on configuring projects and effects for use with the Voyager/Unreal PIERO plugin.

## Going Live

Ensure the **ON AIR** button and **Touch** mode are enabled when going live in PIERO.

### To enable ON AIR and TOUCH modes:

1. In the **Timeline Control Bar**, select the **ON AIR** button to activate **ON AIR** mode.

**ON AIR** mode is activated.

2. Select the **Touch** button to enable **Touch** mode.

**Touch** mode is enabled.



*Timeline Control Bar - ON AIR and Touch Buttons*

PIERO Touch can now be used to draw on the pitch with PIERO touch effects, such as areas, arrows, and spotlights. The PIERO Voyager plugin will mirror these graphics and reproduce them in the perspective of the VR/AR studio camera.

## Voyager/Unreal Workflow

The Voyager/Unreal renderer visualizes a VR or AR studio from the perspective of the studio camera. The PIERO Voyager/Unreal plugin defines a sports pitch/field within the VR or AR studio and mirrors content from PIERO onto that pitch/field.



### Voyager/Unreal Renderer

The Voyager/Unreal workflow for Voyager requires the PIERO plugin to be enabled and connected to PIERO via an Ethernet network. Network connections are defined in the PIERO Manager blueprint **BP\_PieroManager**. Include this actor needs in your Voyager project. The transform details of the actor define where the sport's pitch/field exists within the VR/AR studio.

For more information on configuring the plugin and the PIERO Manager actor, see [Voyager Configuration](#)<sup>[107]</sup>.

### Going Live

Voyager/Unreal should be in **Play** mode to activate the plugin. Then, a connection to PIERO needs to be made. This connection can be configured to automatically occur in the PIERO Manager actor. See [Voyager Configuration](#)<sup>[107]</sup> below for more details.

Once the PIERO plugin is connected, child actors will be automatically created and attached to the PIERO Manager parent actor. These actors match the effects created in PIERO and are positioned at the same pitch/field position. In this way, the Voyager/Unreal output mirrors the graphics in PIERO.

# Voyager - Unreal Configuration

This section covers the Voyager/Unreal Configuration.

## Enabling the PIERO Plugin

### To enable the PIERO Plugin:

1. In the Unreal Editor, from the main menu bar, select the **Edit** menu.
2. From the **Edit** menu, select **Plugins**.

The **Plugin Browser** opens.

3. From the **Plugin Browser**, search for **PIERO** and select the **PIERO Unreal Plugin**.



*Unreal Editor - PIERO Unreal Plugin*

4. Select the **Enabled** checkbox to enable the plugin in your current project.

The PIERO Plugin is displayed in the project content browser.

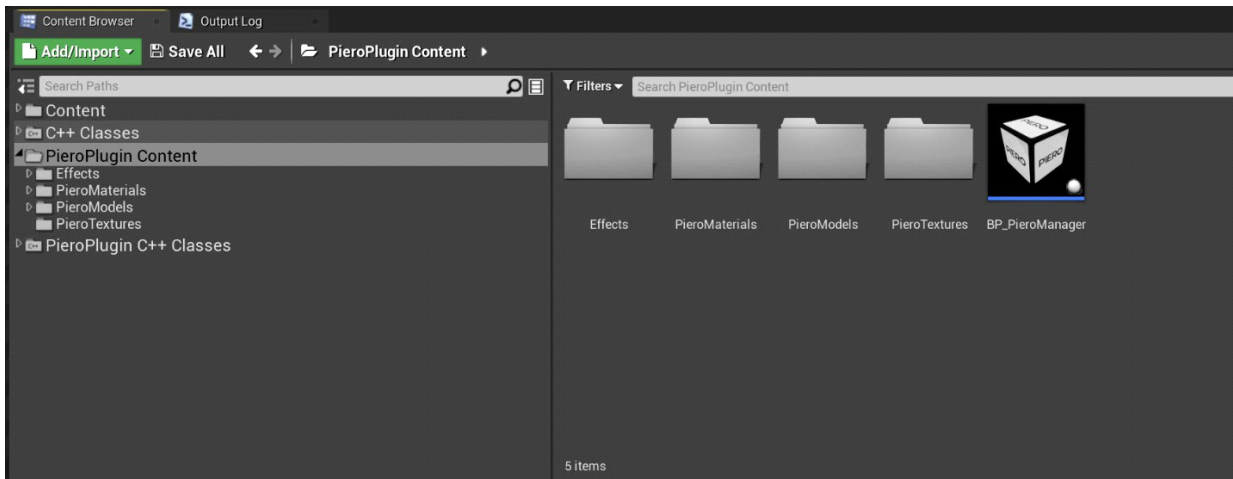

*Project Content Browser - PIERO Plugin*

5. If the PIERO Plugin does not appear in your project content browser, ensure that **Show Plugin Content** or **Show Engine Content** is enabled in the **Settings** menu at the top-right of the content browser.
6. Next, add **PIERO Manager** .

## Adding PIERO Manager

This section covers how to add the PIERO Manager.

### To add PIERO Manager:

1. In the **Project Content** browser, go to the **PieroPlugin Content** folder.
2. From the **PieroPlugin Content** folder, drag the actor named **BP\_PieroManager** onto the scene and place it where you want the PIERO graphics to appear.

This actor can be freely positioned, oriented, and uniformly scaled.

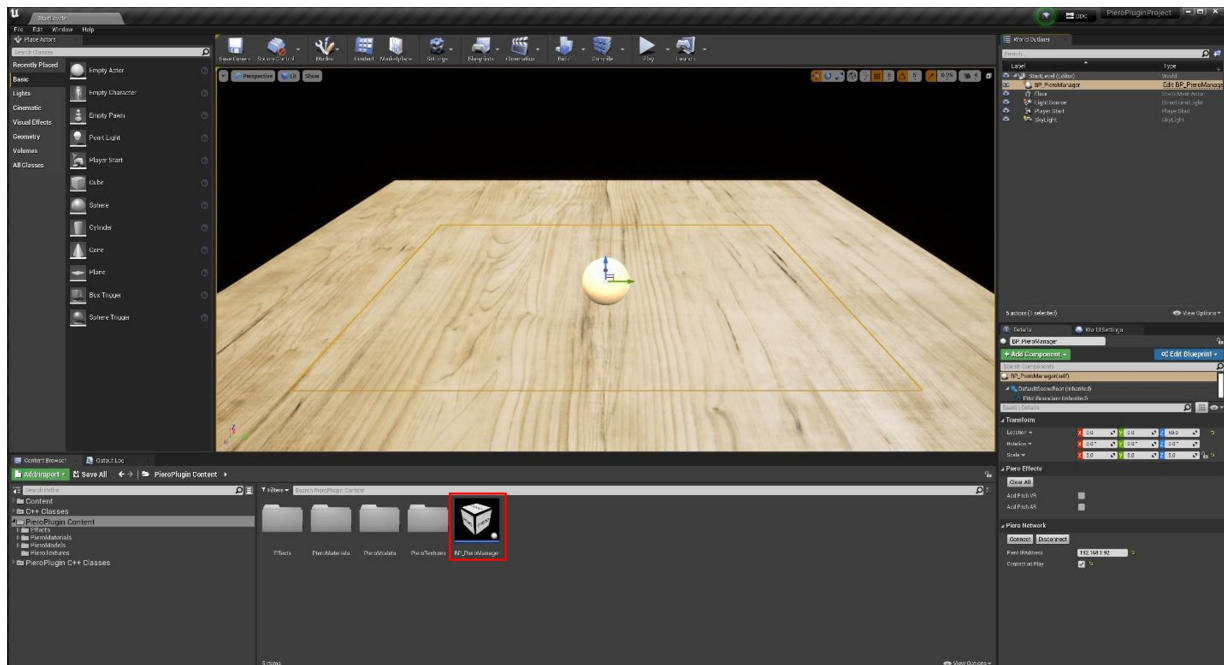

### Content Browser - BP\_PieroManager

A yellow boundary will appear, showing the extent of the PIERO graphics.

This boundary represents the pitch or field boundary for the chosen sport. For football, it typically reflects the FIFA standard pitch dimensions of 105m x 68m with a 105:68 ratio.

3. Position, orient, and uniformly scale the pitch or field anywhere in your scene using this boundary as a guide.

★ Use a uniform scale for the **BP\_PieroManager** actor to avoid deformed graphics.

Additionally, you can customize the yellow boundary by modifying the child component **PitchBoundary** of the actor **BP\_PieroManager**. By default, this component's material is transparent. Apply an opaque material to make it visible, which can help align the pitch or field during play mode, for example. After finalizing the pitch position, reset the **PitchBoundary** material to transparent to prevent it from being visible in the rendered scene.

## PIERO Manager Controls

Selecting the PIERO Manager **BP\_PieroManager** actor in the World Outliner displays the details panel, as shown below. Use the details panel to configure the main control interface of the PIERO Manager.

Additionally, define the **PIERO PC IP address** in this interface to establish network connections to PIERO. For more details, refer to the [Connecting to PIERO](#) section.

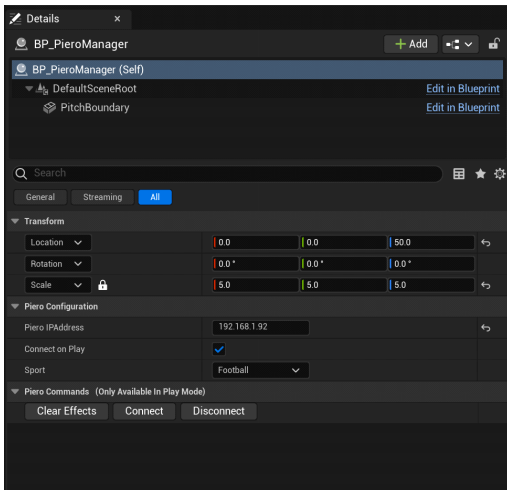

*Details Panel - BP\_PieroManager*

Once connected to PIERO and Unreal is in “Play” mode, the PIERO Manager attempts to mirror the current PIERO project and any contained effects in Unreal by adding equivalent child actors. During this process, Unreal graphics appear in the same place on the pitch as the equivalent effects in PIERO.

For example, adding a marker to the center of the pitch in PIERO also places a marker at the same location in your Unreal scene. This functionality allows PIERO Touch users to add or manipulate graphics directly using the PIERO touch iPad or PC application.

## Connecting to PIERO

The following controls are available in the **Detail Panel** to configure a connection to PIERO:

Control	Description
<b>PIERO IP Address</b>	This text field defines the IP address of the PIERO PC. If the IP address is unknown, you can find it using the <b>Settings/Touch</b> tab on the PIERO UI.  ★ The PIERO PC should be on the same network as the Voyager Unreal PC for the best response. Avoid Wi-Fi to minimize latency and lag.
<b>Connect on Play</b>	Select this checkbox to allow automatic connection when Unreal’s <b>Play</b> mode is activated.  This is recommended as it eliminates the need to manually select <b>Connect</b> or <b>Disconnect</b> when playing or stopping an Unreal project.
<b>Sport</b>	Use this combo box selector to choose the sport.  The selected sport affects the pitch/field yellow boundary of the <b>PitchBoundary</b> component to match the dimensions of the chosen sport. It also determines the file

Control	Description
	location of the spawned blueprint for PIERO effects, such as a baseball blueprint for a PIERO ball effect if baseball is selected.

The following effect controls are also available in play mode:

Effect Control	Description
<b>Clear Effects</b>	Select this button to remove all child effects from the PIERO Manager. This can be useful for quickly clearing the PIERO Manager's content if needed.
<b>Connect</b>	After defining the PIERO IP address in the text field, select this button to attempt a connection to PIERO.  ★ You must be in Unreal <b>Play</b> mode, and the PIERO application must be running, for the connection to succeed. A log message in Unreal and the PIERO application's remote UI panel will confirm an active two-way connection.
<b>Disconnect</b>	Select this button to disconnect from PIERO.  ★ A disconnection occurs automatically when exiting Unreal's <b>Play</b> mode.

## PIERO Plugin Content

The PIERO plugin contains free-to-use Unreal content, including actors, models, materials, and textures for multiple sports. These are used to reproduce a PIERO project in Unreal.

This content is in the **PieroPlugin Content** folder in your content browser. If this folder is missing, ensure the PIERO plugin is enabled and that **Show Plugin Content** is active in the **Settings** menu at the top-right of the Content Browser.

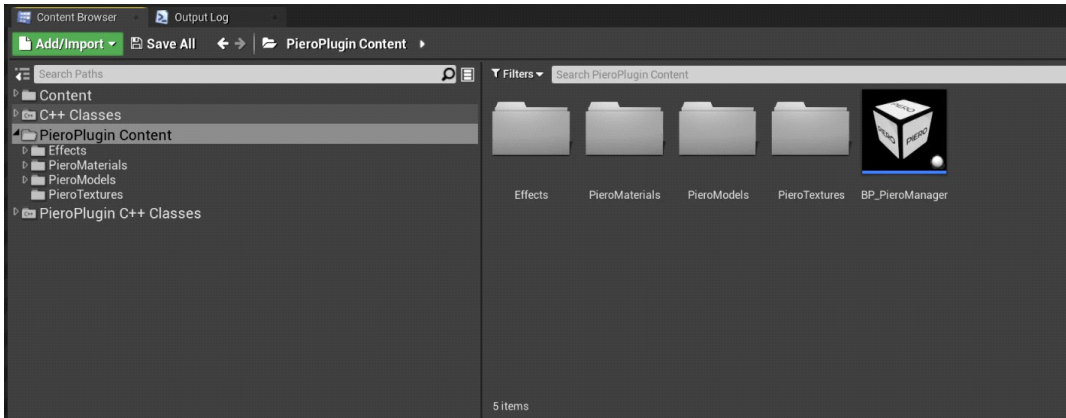

Content Browser - PieroPlugin Content folder

## Plugin Effects

PIERO effects are represented by standard Unreal blueprint actors that are found in the **PieroPlugin Content/Effects** folder, as seen below.

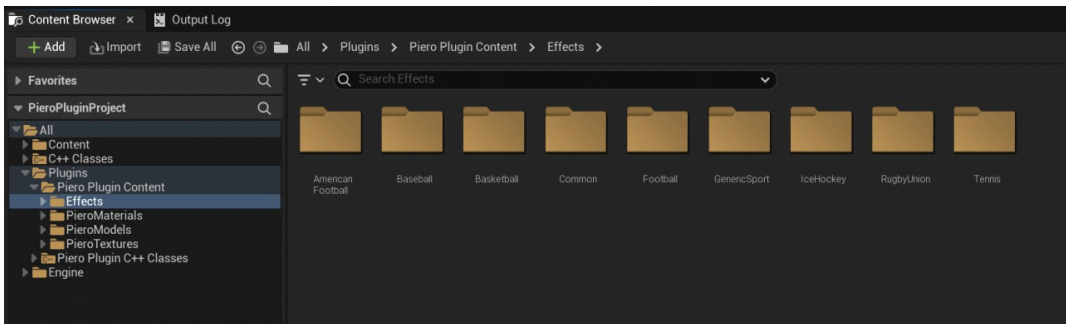

Content Browser - PieroPlugin Content/Effects folder

These actors are equivalent to effects in a PIERO project. When adding an effect in PIERO, the plugin creates the equivalent actor from this folder area and places it as a child of the PIERO manager within the scene. Most blueprint effects are in the **Common** folder, while sports-specific blueprints are in the sports folders.

These actors can be freely customized, allowing custom models and materials to be applied to reproduce PIERO effects. When customizing an actor, maintain the actor hierarchy and component names, as the plugin code directly references them.

A limited selection of PIERO effects and properties are currently implemented for a subset of sports. See the [Supported PIERO Effects](#) section for the subset of currently supported PIERO effects and properties.

## Plugin Models

The PIERO plugin includes a set of Unreal models available for use. These are found in **PieroPlugin Content/PieroModels**, as shown below.

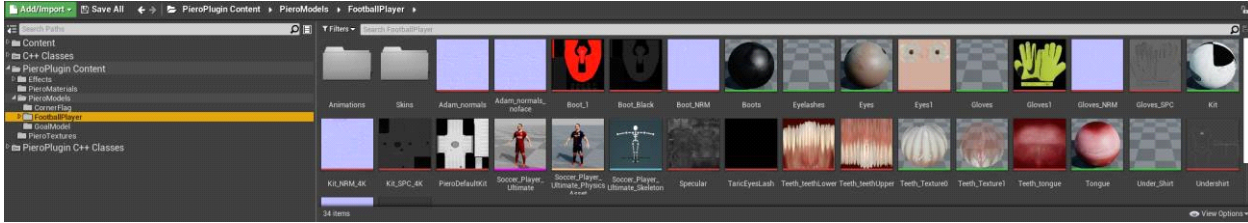

*Content Browser - PieroPlugin Content/Piero Models*

The models are used by the plugin effect actors and include basic shapes and sports-specific models (such as goal and corner flags) along with a customizable 3D football player. The player model can be animated and skinned to match any football team. For information on how to customize a football team or player, see the [Customizing Effects](#) <sup>1031</sup> section.

## Plugin Materials

The PIERO plugin uses a set of Unreal materials, located in **PieroPlugin Content/PieroMaterials**. The **Plugin Materials** are used within the plugin effect actors and can be changed if necessary. This section also contains the font, and updating it allows the project to use a different font.

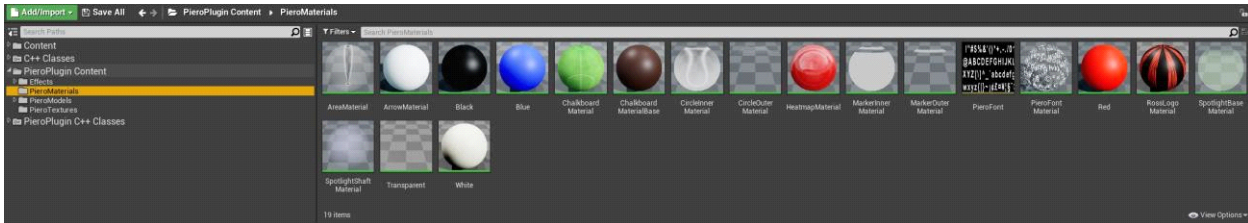

*Content Browser - PieroPlugin Content/PieroMaterials*

## Plugin Textures

The PIERO **Plugin Materials** use a set of Unreal textures located in **PieroPlugin Content/PieroTextures**. These textures can be changed if necessary.

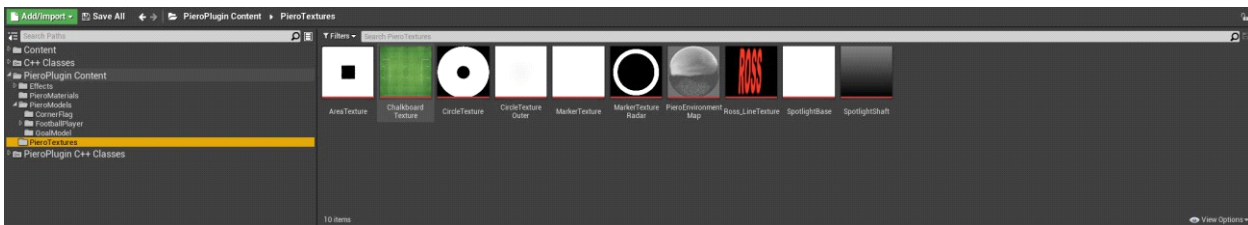

*Content Browser - PieroPlugin Content/PieroTextures*

## Customizing Effects

Effect actors in an Unreal project can be customized without altering the original plugin content by adding a **Piero/Effects/<Sport>** folder hierarchy to the root content folder. Within this folder, place a blueprint actor with the same name as the original blueprint.

For example, a custom **MarkerEffect**, as seen below.

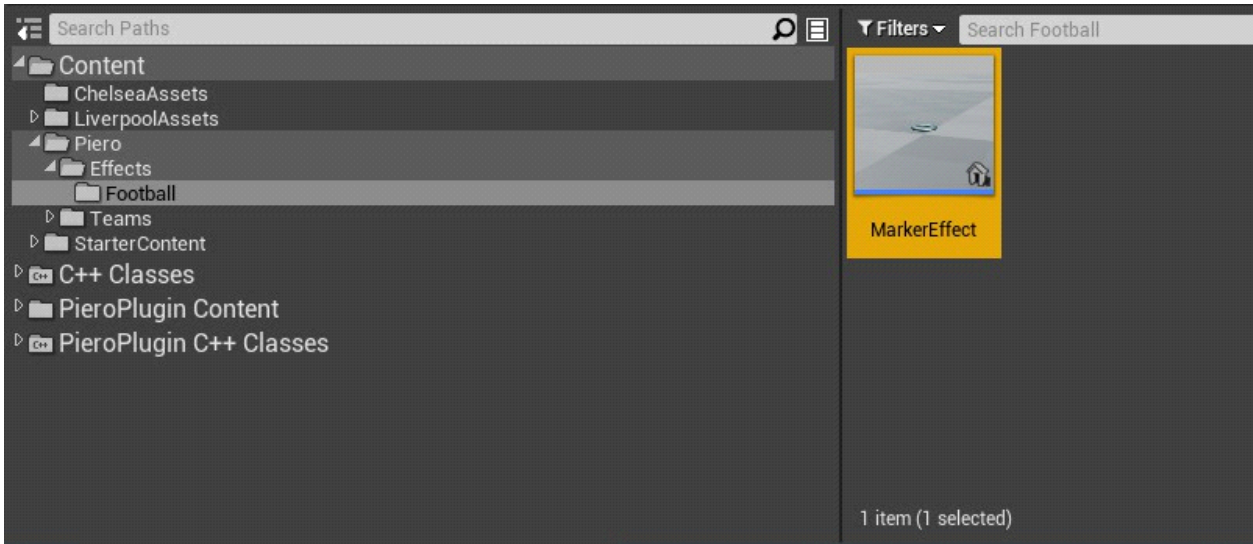

*Custom Marker Effect*

## Customizing Teams

The team line-up effect in PIERO visualizes multiple sports teams and players. The plugin can also visualize the equivalent Unreal team and player actors. A folder hierarchy **Piero/Teams/<Sport>/<Team Name>** should be made in your Unreal project content folder.

For example, if the team name is "Liverpool" then a folder hierarchy "Piero/Teams/Football/Liverpool" should be created.

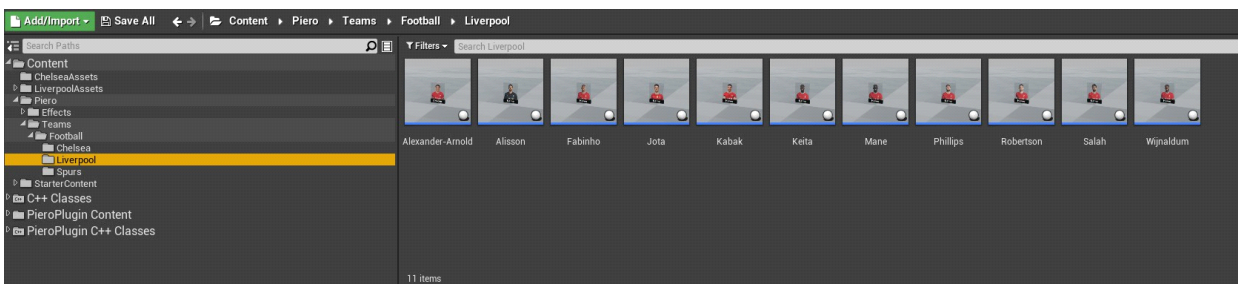

*Folder Hierarchy Example - Piero/Teams/Football/Liverpool*

The <Team Name> string must match exactly the team name when created in the PIERO asset manager. Beneath the team folder are the blueprint actors named with the surname of the players you want to customize. If the surname of a player is "Salah," then a blueprint actor called "Salah" must appear within the team folder.

★ The surname string must match the surname as that defined in the PIERO asset manager.

Using customized blueprints in this way enables visualization of any 3D model, provided the blueprint name matches the player name as described in the [Player Name Rules](#)<sup>[103]</sup> section. This allows to choose between 3D player models or 2D photos, as shown in the image above.

The 3D player model included in the plugin can be customized by dragging/copying the **PlayerEffect** blueprint from **PieroPlugin Content/Effects/<Sport>** to the relevant team folder in the content folder. Rename it to the player's surname or **DefaultPlayer** if a generic 3D player is required for a team.

An Unreal artist can then change the materials and textures of the 3D player blueprint to match the team or player.

Alternatively, you can template photos with a single blueprint. For additional information on templating photos with a single blueprint, see the [Teams with Photo Templates](#)<sup>[103]</sup> section.

## Player Name Rules

When customizing players within a team, the following blueprint actor naming rules apply:

- If a blueprint actor with the player's surname is found in the team folder **Piero/Teams/<Sport>/<Team Name>**, then this will be generated at the correct position on the pitch.
- If a blueprint with the player's surname is not found in the team folder, a blueprint called **DefaultPlayer** will attempt to be loaded from that team folder instead.

This enables a custom blueprint for a whole team to be utilized, rather than having to define every player. This is useful for defining a generic 3D player team model without having to define every player.

- If a blueprint named **Default Player** is not found, then the default **PlayerEffect** blueprint is used from **PieroPlugin Content/Effects/<Sport>/PlayerEffect**.
  - ★ **Note:** If two or more players share the same surname, name the blueprint **<forename><surname>** in the team folder. For example, if John Smith and Brian Smith play for the same team, place a blueprint named "*JohnSmith*" and "*BrianSmith*" in the team folder.
- If two or more players share the same forename and surname, then name the blueprint **<forename><surname><player\_number>**.

## Teams with Photo Templates

An additional templating mechanism exists to make creating teams based on photos easier. Within the PIERO Plugin content folder, the blueprint **Effects/Common/PlayerEffect** serves as an example photo-based player blueprint. Copy this blueprint to a team folder and use it as a template to insert player photos. Name it **DefaultPlayer** in the team folder, and ensure the accompanying textures follow the naming conventions discussed in the [Player Name Rules](#) section.

For example:

For the Liverpool team, the plugin will automatically place the relevant player photo texture into the blueprint **DefaultPlayer**. The component **PlayerImage** must be present in this blueprint in order for the plugin to identify the player photo component. This has already been done for you in this **PlayerEffect** blueprint, which can be customized.

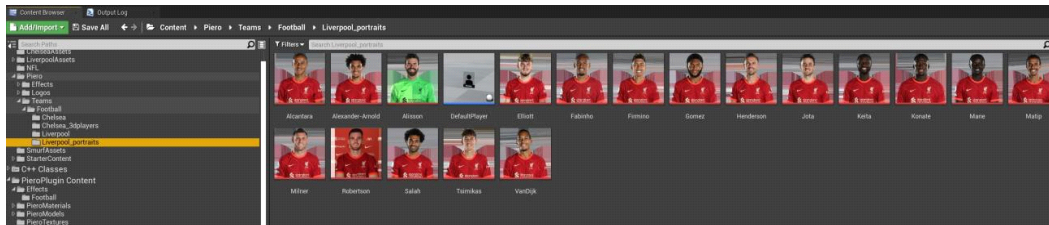

*Example - Team With Photo Template*

## Customizing Logos

Custom team logos can be visualized within the plugin through use of the PIERO logo effect. When adding a logo effect in PIERO, the plugin adds the blueprint **PieroPlugin Content/Effects/<Sport>/LogoEffect**. This adds a default PIERO logo, which can be customized by adding a logo blueprint named with the same asset name to **Content/Piero/Logos/<Sport>**.

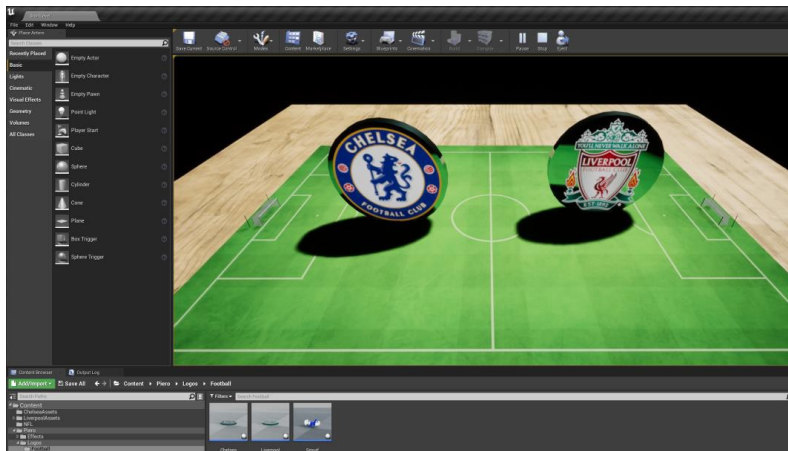

*Custom Logos*

The above image shows custom logos for the blueprints "Chelsea" and "Liverpool", which share the same asset name as that of the PIERO logo effect and have been placed in "Content/Piero/Logos/Football".

## PIERO Configuration

The primary goal for PIERO configuration, when used in conjunction with the plugin, is to pre-define PIERO projects and groups/clips for later control by the PIERO Touch user. These projects and groups generally contain effects that will be visualized from the touch screen, such as team line up effects or data statistics.

★ **Note:** Although the PIERO SDI output is never visible, a blank SDI video input signal must be provided to PIERO. This will not be seen as it is obscured by the virtual stadium; however, it is required to ensure video synchronization between PIERO and Voyager. An SDI reference signal must be provided to PIERO to ensure complete synchronization with Voyager.

### VR Studios

PIERO graphics for VR studios can look slightly different from that of AR studios. Viewers at home typically do not see the output of PIERO touch, so predefined project effects can be tailored with this in mind. For example, team line ups can be markers with player names on the pitch floor to remind the operator which player to interact with. The 3D player graphic is not important, as this is visualized in Voyager/Unreal and will not be seen by viewers.

For VR studios, it is recommended to use predefined projects that are more descriptively useful to the touch user and therefore easier to interact with.

### AR Studios

For PIERO projects involving AR studios, the PIERO Touch output will appear on air if using a touchscreen, and viewers at home will be able to see any PIERO graphics. As the Unreal virtual graphic is of more importance, the PIERO graphic should be less visible and only be present as a visual aid to the PIERO Touch operator.

For example, team line ups can be visualized in Unreal with a virtual 3D player however; the PIERO graphic itself need only be a transparent marker, to allow the touch operator to see which player it is.

Other PIERO Touch effects, such as arrows, also need to be made less visible so that the viewers at home don't see them. This can be done by making them less opaque using the **Opacity** property, for example. Effect presets in PIERO can be used to store these property changes.

## Team Line Up Configuration

A PIERO team line up is configured using the team line up effect. If the Voyager plugin is connected, Voyager will visualize the same team with the same players in the same positions (including substitutes). The PIERO Touch team line up touch tools can then be used to reposition players, including animations using the home or away team line up touch tool.



Example - PIERO Team Line Up Effect

As the output of PIERO Touch will not be seen in a VR studio, it is recommended to configure the team line up effect to show markers rather than players, with text flat on the floor, as shown in the example above. This will allow the Touch user to identify the players when interacting with them.

Additionally, it is recommended to enlarge the touch handle size to 3.0, for example, to aid repositioning of the players. For an AR studio, where the touchscreen is visible on air, it is recommended to only faintly show the markers (by adjusting the opacity) so that they will not be seen by the viewers at home.

## Creation of Teams

Use the [Asset Manager](#) <sup>257</sup> to create teams for use with the team line up effect. The Asset Manager allows the input of player names and positions for a team.

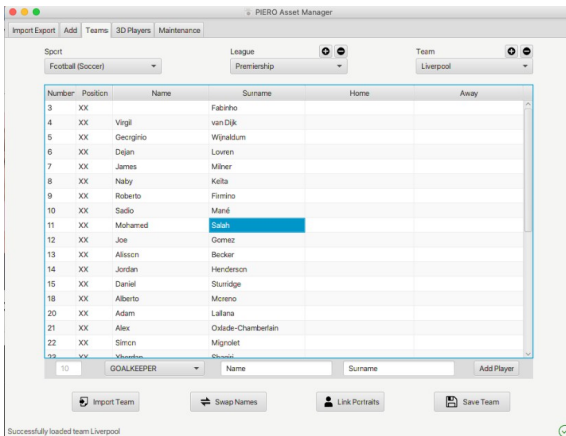

Asset Manager - Player Names

## OPTA Graphics Configuration

PIERO statistical graphics can be shown in Voyager using the PIERO Opta data module to generate statistical graphics. Currently supported statistics in the plugin include touch maps, heat maps, and pass maps. Use the OPTA module to generate the relevant effects in PIERO within a group (as seen in the example below). The group can then be animated on/off, and the statistical graphic will be mirrored and visualized in the Voyager plugin.



*PIERO - OPTA Module Generate Effects*

## Supported PIERO Effects

The following subset of PIERO effects and properties are currently implemented:

PIERO Effect	Touch Effect Supported	Unreal Blueprint	PIERO Properties Supported
<b>Area Effect</b>	Yes	AreaEffect	<ul style="list-style-type: none"> <li>• Height</li> <li>• Color</li> <li>• Opacity</li> <li>• Border Color</li> <li>• Border Width</li> </ul>
<b>Ball Track Effect</b>	No	BallEffect	<ul style="list-style-type: none"> <li>• Show Ball</li> <li>• Ball Radius</li> <li>• Trail Opacity</li> <li>• Trail Size</li> <li>• Trail Glow Color</li> <li>• Trail Fade Color</li> <li>• Trail Glow Intensity</li> </ul>
<b>Caption Effect</b>	No	CaptionEffect	<ul style="list-style-type: none"> <li>• Size</li> <li>• Ground Height</li> <li>• Text (first line only)</li> <li>• Text Color</li> </ul>
<b>Chalkboard Effect</b>	No	ChalkboardEffect	<ul style="list-style-type: none"> <li>• Block Edge Thickness (where zero means don't draw pitch block).</li> <li>• Draw Models (determines whether goal and flag models are drawn).</li> </ul>
<b>Circle Effect</b>	Yes	CircleEffect	<ul style="list-style-type: none"> <li>• Radius</li> <li>• Height</li> <li>• Color</li> <li>• Opacity</li> <li>• Border Color</li> <li>• Border Width</li> </ul>
<b>Distance Effect</b>	Yes	StraightArrowEffect	<ul style="list-style-type: none"> <li>• Color</li> <li>• Opacity</li> <li>• Size</li> <li>• Height</li> <li>• Thickness</li> </ul>
<b>Freehand Arrow</b>	Yes	ArrowEffect	<ul style="list-style-type: none"> <li>• Color</li> <li>• Second Color</li> <li>• Use Gradient</li> </ul>

<b>PIERO Effect</b>	<b>Touch Effect Supported</b>	<b>Unreal Blueprint</b>	<b>PIERO Properties Supported</b>
			<ul style="list-style-type: none"> <li>• Start Transparency</li> <li>• Opacity</li> <li>• Size</li> <li>• Height</li> <li>• Thickness</li> </ul>
<b>Heatmap Effect</b>	No	HeatmapEffect	<ul style="list-style-type: none"> <li>• Color Table</li> <li>• Opacity</li> <li>• Grid resolution</li> <li>• Height</li> </ul>
<b>Kick Arrow Effect</b>	Yes	ArrowEffect	<ul style="list-style-type: none"> <li>• Color</li> <li>• Second Color</li> <li>• Use Gradient</li> <li>• Start Transparency</li> <li>• Opacity</li> <li>• Size</li> <li>• Height</li> <li>• Thickness</li> </ul>
<b>Laser Eye Effect</b>	Yes	LaserEyeEffect	<ul style="list-style-type: none"> <li>• Origin Height</li> <li>• End Height</li> </ul>
<b>Logo Effect</b>	No	LogoEffect	<ul style="list-style-type: none"> <li>• Logo Asset</li> <li>• Position</li> <li>• Size</li> <li>• Height</li> <li>• Orientation</li> <li>• Billboard</li> </ul>
<b>Marker Effect</b>	Yes	MarkerEffect	<ul style="list-style-type: none"> <li>• Color</li> <li>• Pulsing</li> <li>• Size</li> <li>• Height</li> <li>• Opacity</li> <li>• Marker Graphic</li> <li>• Text</li> <li>• Spin Speed</li> <li>• Marker Spin Speed</li> <li>• Marker Pulsing</li> <li>• Marker Height</li> </ul>

<b>PIERO Effect</b>	<b>Touch Effect Supported</b>	<b>Unreal Blueprint</b>	<b>PIERO Properties Supported</b>
			<ul style="list-style-type: none"> <li>• Trail Glow Color</li> <li>• Trail Fade Color</li> <li>• Trail Size</li> <li>• Trail Glow Intensity</li> <li>• Trail Height</li> </ul>
<b>Point to Point Area</b>	Yes	PointToPointEffect	<ul style="list-style-type: none"> <li>• Area Color</li> <li>• Opacity</li> <li>• Height</li> <li>• Border Width</li> <li>• Border Color</li> </ul>
<b>Point to Point Line</b>	Yes	PointToPointEffect	<ul style="list-style-type: none"> <li>• Area Color</li> <li>• Opacity</li> <li>• Height</li> <li>• Border Width</li> <li>• Border Color</li> </ul>
<b>Point to Point Dynamic</b>	No	PointToPointEffect	<ul style="list-style-type: none"> <li>• Area Color</li> <li>• Opacity</li> <li>• Height</li> <li>• Border Width</li> <li>• Border Color</li> </ul>
<b>Spotlight Effect</b>	Yes	SpotlightEffect	<ul style="list-style-type: none"> <li>• Spotlight Source</li> <li>• Height</li> <li>• Size</li> </ul>
<b>Team Line Up</b>	Yes	PlayerEffect PlayerEffectImage	<ul style="list-style-type: none"> <li>• Player name</li> <li>• Player number</li> <li>• Player Orientation</li> <li>• Player Size</li> <li>• Team</li> <li>• Is Away Team</li> <li>• Skin Color</li> </ul>
<b>Text Effect</b>	No	TextEffect	<ul style="list-style-type: none"> <li>• Text (first line only)</li> <li>• Text Color</li> <li>• Background Color</li> <li>• Position</li> <li>• Size</li> <li>• X Scaling</li> </ul>

<b>PIERO Effect</b>	<b>Touch Effect Supported</b>	<b>Unreal Blueprint</b>	<b>PIERO Properties Supported</b>
			<ul style="list-style-type: none"> <li>• Orientation</li> <li>• Tilt</li> <li>• Height</li> </ul>
<b>Track Effect</b>	No	TrackEffect	<ul style="list-style-type: none"> <li>• Color</li> <li>• Size</li> </ul>
<b>3D Animated Player</b>	No	PlayerEffect PlayerEffectImage	<ul style="list-style-type: none"> <li>• Player Initial Orientation</li> <li>• Player Scale</li> <li>• Team</li> <li>• Surname</li> <li>• Skin Color</li> </ul>
<b>AR Players Effect</b>	Yes	ARPlayersEffect	<ul style="list-style-type: none"> <li>• Player Scale</li> <li>• Player Ground Height</li> <li>• Face Camera</li> <li>• Arrow Size</li> <li>• Arrow Color</li> <li>• Arrow Height</li> <li>• Arrow Thickness</li> <li>• Arrow Opacity</li> </ul>
<b>Vertical Grid Effect</b>	No	MakerEffect	<ul style="list-style-type: none"> <li>• Marker Positions</li> <li>• Marker Text</li> <li>• Marker Asset</li> <li>• Marker Color</li> <li>• Marker Opacity</li> <li>• Marker Size</li> <li>• Marker Spin Speed</li> <li>• Text Color</li> <li>• Text Opacity</li> <li>• Text Size</li> </ul>

## Supported PIERO Sports

The following PIERO sports are supported by the plugin, although a **Generic** sport is available to cover other sports:

- Football
- American Football
- Baseball
- Basketball
- Ice Hockey
- Rugby Union
- Tennis
- Generic Sport

# PIERO Effects

- [3D Player](#) <sup>264</sup>
- [3D Player Data](#) <sup>130</sup>
- [3D Animated Player](#) <sup>132</sup>
- [3-Point Line](#) <sup>135</sup>
- [AR Players](#) <sup>136</sup>
- [Arc](#) <sup>138</sup>
- [Area](#) <sup>140</sup>
- [Arrow \(Distance\)](#) <sup>142</sup>
- [Arrow \(Freehand\)](#) <sup>144</sup>
- [Arrow \(Height\)](#) <sup>146</sup>
- [Caption Track](#) <sup>149</sup>
- [Circle](#) <sup>151</sup>
- [Counter](#) <sup>154</sup>
- [Cross Hair Marker](#) <sup>155</sup>
- [Curved Arrow](#) <sup>157</sup>
- [Direction of Play](#) <sup>158</sup>
- [Distance to Goal](#) <sup>159</sup>
- [Down and Distance](#) <sup>161</sup>
- [Dynamic Formation](#) <sup>166</sup>
- [Freehand 2D Line](#) <sup>169</sup>
- [Goal Zone](#) <sup>170</sup>
- [Laser Eye](#) <sup>171</sup>
- [Laser Wall](#) <sup>172</sup>
- [Logo](#) <sup>173</sup>
- [Magnifier](#) <sup>175</sup>
- [Tracked Magnifier](#) <sup>175</sup>
- [Markers](#) <sup>177</sup>
- [Tracked Marker](#) <sup>177</sup>
- [Measurement Table](#) <sup>180</sup>
- [Moveable Players](#) <sup>182</sup>
- [Movie](#) <sup>184</sup>
- [Multicam](#) <sup>185</sup>
- [Offside Marking](#) <sup>189</sup>
- [Pitch Zone](#) <sup>191</sup>
- [Player Data Track](#) <sup>194</sup>
- [Player Glow/Grow](#) <sup>196</sup>
- [Player to Player](#) <sup>197</sup>
- [Point Map](#) <sup>199</sup>
- [Point to Point](#) <sup>201</sup>
- [Range](#) <sup>203</sup>
- [Red Zone](#) <sup>204</sup>
- [Removable Players](#) <sup>205</sup>
- [Rugby Gain Line](#) <sup>209</sup>
- [Scores and Badges](#) <sup>210</sup>
- [Screen](#) <sup>211</sup>
- [Smash-o-Meter](#) <sup>212</sup>
- [Sound](#) <sup>214</sup>
- [Spotlight](#) <sup>215</sup>
- [Tracked Spotlight](#) <sup>215</sup>
- [Tactical Board](#) <sup>218</sup>
- [Team Line-up](#) <sup>219</sup>
- [Tennis Score](#) <sup>224</sup>
- [Text](#) <sup>225</sup>
- [Time Lapse](#) <sup>227</sup>
- [Time Lapse Run](#) <sup>227</sup>
- [Timer Text](#) <sup>230</sup>
- [Title Text](#) <sup>231</sup>
- [Track](#) <sup>232</sup>
- [User Model](#) <sup>234</sup>
- [Vertical Grid Effect](#) <sup>235</sup>
- [Virtual Ball](#) <sup>240</sup>
- [Video Effect](#) <sup>237</sup>
- [Video Filter Effect](#) <sup>238</sup>
- [Virtual Camera](#) <sup>246</sup>
- [Virtual Camera Live](#) <sup>246</sup>
- [Virtual Camera Spline](#) <sup>246</sup>
- [Virtual Presenter](#) <sup>248</sup>
- [Virtual Stadium](#) <sup>253</sup>
- [Zoom](#) <sup>255</sup>



## Tips for Using PIERO Effects

The effects available for use in PIERO are determined by the sport selected in the Launcher, with modification options accessible through the property sheet or direct interactions in the video window.

Keying and calibration are generally recommended to enhance the effectiveness of these effects; however, it's important to note that not all effects require these steps. Users should refer to the specific entries for each graphic effect to determine if keying and calibration are necessary.

Additionally, available for some effects, there is a **Keyed** checkbox in the property sheet which allows users to decide whether the effect should interact with pre-configured keyed elements. When this option is unchecked, the effect is applied over the video without utilizing the key.

Similarly, the **2D** property, also available for some effects, enables effects to be rendered in a flat, two-dimensional format. This property is especially beneficial in fast-paced environments where there is insufficient time for detailed keying or calibration.

Read the following tips to ensure satisfactory results.

- Consider performing calibration and applying an RGB Keyer for each effect to ensure they appear in the correct position and perspective on the pitch.
- You can add sound to any effect, if you select the appropriate audio option in the launcher. Some effects have sound built in, allowing for the sound effect to be triggered separately.
- The [Moveable Players](#)<sup>182</sup>, [Player Glow/Grow](#)<sup>196</sup> and [Removable Players](#)<sup>205</sup> will look and function better if you add the [Region Tool](#)<sup>75</sup> to your project and make sure the player(s) you want to interact with are defined.
- Information such as keyboard shortcuts and mouse controls is available by hovering over the "i" icon in the top-right corner of the effect's property sheet.
- If you see that the calibration overlay is jumping around when you're adding or editing an effect or the effect itself is jumping around, select the **Calibration** line in your project and then click **Find** to re-establish the calibration.
- Use **2D** property for adapting graphics to different broadcast scenarios, especially in conditions where traditional keying and calibration might be impractical.

## 3D Players



The 3D Player effect is used to position and pose 3D players defined in the [Asset Manager](#) <sup>[257]</sup>.

This effect requires [Calibration](#) <sup>[34]</sup> and a [Keyer](#) <sup>[32]</sup>.

The teams, strips (uniforms) and players defined in the Asset Manager can be selected and edited in the property sheet. Other editable properties include the orientation of the player (whether facing left or right on the pitch) and the shadow the player emits. Once the properties of the 3D player have been selected, the user can place the 3D players onto the pitch.



*3D Player Effect*

### To use the 3D Player effect:

1. Add the 3D Player effect to the project.
2. In the **Properties** sheet, set the properties of the first player.
3. Click on the feet of the player(s) in the video to add one or more 3D players to the pitch.

The 3D player will default to the direction set in the **Orientation** property. Use the mouse wheel to rotate the player until it's facing the correct direction, if necessary.

The 3D player assumes the default stand pose.

4. Double-click on the handle (the square beneath the player).

This will bring up the **POSES** interface.

The left-hand side of the interface displays a magnified portion of the video, enabling selection of the pose required. The right-hand side displays the categories of poses available in the library. The goal is to select a pose that closely matches the video of the player.

5. Click on the pose category that matches the player's action, for example - Running.

This will bring up 9 running poses.



*3D Player - Running Poses*

6. Select the running pose you want and then select the **POSES** button to return to the pose categories.
7. Click on the individual pose that most closely matches the video on the left to overlay a 3D posed model onto the video.  
Click the pose again to remove the model.
8. Adjust the player's pose according to the following table.

<b>Right Mouse Button</b>	Click and drag the right mouse button over the player in the video portion of the interface to adjust the player's height, for a closer match.
<b>Mouse Wheel</b>	Use the mouse wheel to rotate the player or left-click on a green ball and drag to rotate the player.
<b>Blue 3D Balls</b>	Left-click and drag the blue ball to reposition the player.
<b>Articulation Nodes</b>	<p>Click on the left-hand side panel to display the articulation nodes and right-click a node to bring up the rotation disc, which can be rotated with the mouse wheel.</p> <ul style="list-style-type: none"> <li>• Red nodes control the right side of the body.</li> <li>• Yellow nodes control the left side of the body.</li> <li>• Black nodes control the spine.</li> <li>• Clicking away from the node makes the disc disappear.</li> <li>• Right-clicking a node several times will change the disc axis.</li> </ul>  <p><i>3D Player - Articulation Nodes</i></p> <p>Two planes can be used to drag the articulation nodes:</p> <ul style="list-style-type: none"> <li>• A vertical plane parallel to the screen.</li> <li>• A horizontal plane parallel to the ground.</li> </ul> <p>Switch between the two planes by left-clicking the mouse.</p>
<b>Cubic Nodes</b>	<p>Left-click and drag the cubic nodes to adjust the hands, elbows and feet. The rest of the body will adjust accordingly.</p> <p>The plane will move with the node it is attached to and eventually intersects with the player's body. This allows you to ensure that a hand or foot has not been placed in an unnatural position.</p> <p>Planes are parallel to the screen not to the player face. If you are changing the player orientation with the mouse wheel, the planes will behave differently and drag the articulation nodes in a different way. Experiment with dragging the planes while spinning the player to fully understand this.</p>

9. When you are satisfied that you have a close match for a player, select **SAVE**.  
If you need to start over, you can select **RESET** to go back to the default pose.

10. If you have more 3D players to pose, select the **NEXT** button to go the next player.

**OR**

If you are finished, select **DONE** to revert to the normal PIERO video screen.

The posed players will then be displayed at their normal size.

**To change a player's strip:**

1. Click the yellow square beneath the player whose strip (uniform) you want to change.
2. In the 3D Player effect property sheet, from the **Strip** drop-down, select the strip you want to use (**Home**, **Away** or **Goalkeeper** strip).

**To configure 3D player text:**

1. After adding a 3D player, in the property sheet, select the **Show Player Name** checkbox.  
A text box appears above each 3D player.
2. From the **Name Layout** drop-down, select what text you want to appear.  
The text you choose will be drawn from the [Asset Manager](#)  257.
3. In the **Height Offset** field, enter a value to determine the offset of the text from the top of the 3D player's head, with **0.00** being immediately over the head.

## 3D Player Data



The 3D Player Data effect provides automatic animation of 3D players based on player positional data.

This effect requires [Calibration](#)<sup>[34]</sup> and a [Keyer](#)<sup>[32]</sup>.

The player data is imported from an external system such as the SportVU system or from the PIERO remote link.



*3D Player Data Effect*

### To use the 3D Player Data effect:

1. Add a 3D Player Data effect to the project.
2. Set the **In** and **Out** point using the timeline to determine the limits of the player data needed for import.
3. In the property sheet, from the **Data Directory** property, select the player data directory where the data resides.

The data will automatically load for the duration defined in Step 2.

4. If precise synchronization is required, in the **Data Offset** property, adjust the value to offset the data by a number of frames.
5. Select the strips of the players and referee.

The available strips are those created using the [Asset Manager](#)<sup>[257]</sup>.

6. Use the **Player Properties > Add** and **Remove** menus to add or remove various graphical effects as required.

The graphical effect will be added to all players by default, or if an individual player(s) is selected (by selecting the marker underneath the player) the effect will apply only to the selected player(s).

The graphical effects that can be applied include:

- **3D Player** - The 3D player model can be added or removed.
- **Marker** - The marker beneath the player can be added or removed.
- **Pulsing Marker** - The marker beneath a player can be made to pulse.
- **Trail** - A trail can be added to each player showing his path.
- **Speed Trail** - The speed of the player can be shown as a color along a path.
- **Spotlight** - A spotlight can be added to highlight a player.
- **Shadow** - The virtual shadow beneath a player can be added or removed.
- **Ball** - The ball can be added or removed (if present in the player data).
- **Ball Trail** - The ball path can be shown (if present in the player data)
- **Offside Line** - The home or away offside line can be shown based on the player data.
- **Team Shape** - The home or away team shape can be shown based on the player data.
- **Goalkeeper** - A 3D player can be forced to be a goalkeeper if this information is missing from the player data.

7. Select a player and enter text into the **Set Text** property if required.

The text will default to the players name or number (if defined in the Asset Manager).

8. Use the right mouse button to reposition the text and use the mouse wheel to scale the text.

9. Double-click on the marker at the base of a player to pose the player for an individual video frame.

This is useful for a pause point where the pose needs to be very precise for a single frame of video. This pose will override the normal animation poses that are applied to the 3D players. Posing the players is similar in procedure to posing static 3D players.

10. In the **Virtual Camera Properties > Camera Position** and **Look at Position** properties, select a player number/name to add an additional virtual camera to the project, if you want to show the player's point of view based on the player data effect.

## 3D Animated Player



The 3D Animated Track effect combines a 3D player with a track effect in order to control an animated version of the player along the track.

The 3D player's motion matches that of the tracked player automatically.

This effect requires [Calibration](#)<sup>34</sup> and a [Keyer](#)<sup>32</sup>.

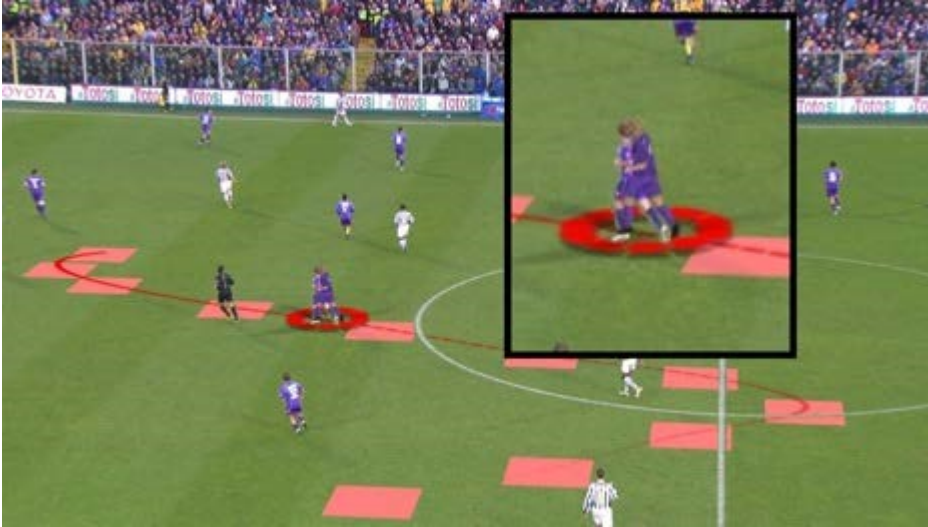

*3D Animated Track Effect*

### To use the 3D Animated Track effect:

1. Add a 3D Animated Track effect to a project.
2. From the property sheet, select the appropriate team and player.
3. Double-click a new position in the video window to reposition the player.
4. Start tracking the player as if it was a regular track effect.
5. Add keypoints in the track for each change of speed and direction.
6. Press the **Add Start Pose** and **Add End Pose** buttons at the appropriate time code if required.

The animation will start and end with the given 3D poses.

7. To display the full track of the player, select the **Show Whole Track** checkbox

### To add extra poses throughout the track:

1. Click the **Add Animation** button to briefly blend the player to that pose through the animation.
2. Custom poses (dragging arms and legs) aren't possible. If the player is running in a curved trajectory, it will retain its tilt (leaning left or right).

This is intended to be used outside a VTR pause.



*3D Players (Animated) Controls*

3. Click the **Add Pose** button to add a custom position in a VTR pause.

The player will blend to the custom pose. The tilt angle will be ignored for this time code. You can customize the pose further by dragging arms and legs with this option.

#### To add the player's name:

1. In the **Text Settings**, select the **Show Player Name** checkbox.
2. From the **Name Layout** drop-down, select what text you want displayed (**Forename, Surname, Number** and **Surname**, etc.).
3. Use the **Size** slider to change the text size.
4. Edit the other text properties in the **Text Settings, Text Style** and **Text Shadow** sections as necessary.

#### To display a track measurement:

- Change the **Text Measure** property to the relevant unit, such as length or speed.

It is not possible to display a text string and a measurement at the same time.

## Specific Properties

The following parameters can be used to customize the effect.

Parameter	Description
<b>League and Team</b>	Select the team from which to populate the players.
<b>Strip and Player</b>	Select the player and their strip (uniform) for this animated track.
<b>Is a Goal Keeper</b>	The selected player will walk and jog backward to simulate goal keeper movements.
<b>Goal Keeper opposite side</b>	The goal keeper will face the opposite end of the pitch, forcing them to animate in the correct direction.
<b>Goal Keeper Look-at</b>	The goal keeper can look at another track such as an attacker track or the ball track.
<b>Show 3D Player</b>	Select the checkbox to make the 3D player visible.

All players should be tracked manually and then the finished scene played out in the virtual stadium from any camera angle.



*3D Players (Animated)*

## 3-Point Line



The **3-point Line** effect for basketball highlights the 3-point line with customizable styles, such as laser or glow effects, adding visual impact to enhance the game's viewing experience.

The **3-Point Line effect** requires [calibration](#)<sup>[34]</sup> and a [keyer](#)<sup>[32]</sup>.



*Three Point Line Effect*

### To use the 3-Point Line effect:

1. In the Launcher, ensure basketball is selected for the sport mode.
2. Add the **3-point Line** effect to the project.
3. Select which end of the court you want the effect to appear on.
4. In the parameter sheet, from the **Transition** drop-down, select an animate option (**On**, **Off**, **Mix On/Mix Off**).

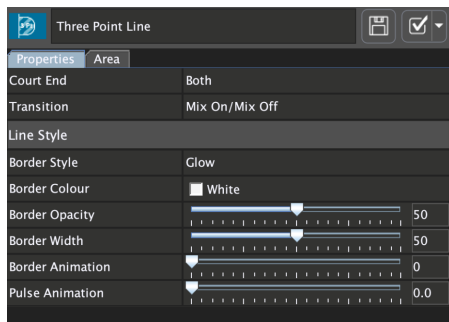

*Three Point Line Effect Parameters*

5. In the **Line Style** section of the parameter sheet, adjust the desired styles for the line.

★ **Note:** The **Pulse Animation** slider controls the rate at which the border pulses.

# AR Players



The AR Players effect records player regions from the video, allowing them to be repositioned at different points in the timeline. This effect is particularly useful for side-by-side analysis of a player's movement over time. Additionally, multiple regions can be recorded to analyze groups of players.

This effect requires [Calibration](#)<sup>34</sup> and a [Keyer](#)<sup>32</sup>.



*AR Players Effect*

## To use the AR Players effect:

1. Add the **Region Tool** to the project.
2. Use the **Polygon Selection** to define a custom region by drawing segments around a player.
3. Add the **AR Players** effect to the project.
  - A pink outline surrounds the player, accompanied by a handle positioned below.
4. Click and drag the handle to reposition the player.
5. Advance the video to the frame you want and add a Pause.
6. Drag the **AR Player** effect along the timeline to the desired position in the video.
7. Select **ON AIR** to play the video through.
8. Additionally, the following features can be added and customized in the property sheet:
  - a. In the **Shadows** tab, you can add and configure a shadow.
    - OR**
    - Select **None** if you do not want to apply a shadow style.
  - b. In the **Markers** tab, you can add and configure a marker.
    - OR**
    - Select **None** if a marker is not required.
  - c. In the **Arrow** tab, define the appearance of the arrow.
    - OR**
    - Select **None** if you don't want an arrow.

## AR Players in Touch Mode

The **RGB Keyer**, **Pause**, and **Region Tool** must be configured before using the **AR Players** effect in Touch mode. The **RGB Keyer** detects players, while the **Region Tool** defines the detected regions.

# Arc



The Arc effect measures an angle, points to the goal, or can be used as an alternative to the [Circle](#) <sup>151</sup> effect.

This effect requires [Calibration](#) <sup>34</sup> and a [Keyer](#) <sup>32</sup>.

★ The requirements for Calibration and Keying do not apply when the **2D** property is enabled, as the effect is then rendered in two-dimensional format without depth cues.



*Arc Effect*

When a player takes a free kick, it is against the rules for any other player to stand within ten yards of the ball. The Arc effect can be used to illustrate the area from which the other players are forbidden.

The arc effect can be used in several ways. You can point the arc towards the goal, extend the lines to the goal posts (as seen above) or extend the whole area to the goal line.

## To use the Arc effect:

1. Add the Arc effect to the project.

The arc will automatically be placed at the correct size (10 yard diameter).

2. Left-click and drag inside the box to reposition the arc.

3. Left-click and drag the control points of the arc to change the arc's size and angle.

4. In the property sheet, select the **Arc** tab and adjust the following properties as needed:

- **Radius (m)**: Set the radius of the arc.
- **Height**: Adjust the height of the arc.
- **Keyed**: Use the checkbox to toggle the use of the Key for the effect, applying it with or without the key as needed.
- **2D**: Select the checkbox to render the effect in two-dimensional format as needed.
- **Point to Goal**: Direct the arc towards the goal.
- **Extend Lines**: Increase the arc's lines beyond their original endpoints.
- **Extend Area**: Increase the area covered by the arc.
- **Link to Track** <sup>232</sup>: Associate the arc with a specific [track](#) <sup>232</sup>.
- **Transition**: Configure the transition effect for the arc.

5. In the **Area** and **Border** tabs, define the appearance of the arc.

6. In the **Measurement** tab, from the **Text Type** drop-down, select whether you want the **Distance to Goal** measurement or the **Arc Angle** measurement to be displayed.

**OR**

Select **None** if you don't want any text.

7. If you chose to display text, configure the **Prefix** and **Suffix** text settings as desired.

**To position the arc using the keyboard:**

- Press the right arrow to aim the arc at the right goal.
- Press the left arrow to aim the arc at the left goal.

# Area



The Area effect is used to highlight a section of the pitch that is relevant to a particular incident or strategy.

This effect requires [Calibration](#) <sup>34</sup> and a [Keyer](#) <sup>32</sup>.

★ The requirements for Calibration and Keying do not apply when the **2D** property is enabled, as the effect is then rendered in two-dimensional format without depth cues.

The **Area** effect allows several different styles, as shown below.



*Area Effect - Style Examples*

## To use the Area effect:

1. Add an Area effect to the project.  
A default square appears with handles at each corner.
2. Left-click and drag the center part of the square to reposition the area.  
**OR**  
Use the arrow keys to reposition the area.  
**OR**  
Press **Ctrl + Arrow** keys to reposition the area in smaller increments.  
**OR**  
Press **Shift + Arrow** keys to reposition the area in larger increments.
3. Left-click and drag the corners to re-size the area.
4. In the property sheet, select the **Area** tab and adjust the width, length, and height of the effect.
5. Use the **Keyed** checkbox to toggle the use of the Key for the effect, applying it with or without the key as needed.
6. Select the **2D** checkbox to render the effect in two-dimensional format as needed.
7. From the **Transition** drop-down, select the desired transition style for the effect.
  - **Animate** - draws the arrow from zero to the given height.
  - **Mix** - fades in the arrow with no change in height.
8. Adjust the style as desired using the options in the **Area Style** section.
9. Select the **Border** tab to configure the border style for the effect.

### To adjust the Area effect's appearance:

1. In the property sheet, adjust its **Height, Gradient, Style, Border Style, Shadow** and **Thickness** to match a broadcaster's graphical chart.
2. Press **Set-as-Default** once the parameters are set.

## Area Effect for Piero Touch

This section outlines how to use the effect in Piero Touch.

### To configure the Area effect for Piero Touch:

1. In PIERO, select the **Touch** button to enable Touch mode.
2. Add an Area effect to the project.
3. Left-click and drag to draw the effect on the play field.
4. In the property sheet, adjust the **Area** and **Border** properties in the property sheet, following the same steps outlined in the [Using the Area Effect in Analysis Mode](#) <sup>140</sup> procedure.
5. Adjust its size by dragging each corner individually.  
In **Touch** mode, the handles are active but not visible.
6. Move the whole shape by dragging it from its center point.

### To use the Area effect in Piero Touch:

1. Add a 2D Area effect to the project.  
The effect is not visible until the user draws it on the touchscreen or iPad.
2. Adjust its size by dragging each corner.  
In Piero Touch, the handles are active but not visible.
3. Move the whole shape by dragging it from its center point.

## 2D Area Effect



The 2D Area effect is used to highlight a section of the pitch that is relevant to a particular incident or strategy in Touch mode. This effect maintains a two-dimensional perspective, ensuring that the highlighted area is visually distinguished without any depth.

The procedure for using and configuring the 2D Area effect in Touch follows the same steps as the standard Area effect in Touch mode. The primary difference lies in the default settings: for the 2D Area effect, the **2D** checkbox is selected by default to maintain a flat, two-dimensional appearance, while the **Keyed** checkbox is not selected. This distinction is important for users to note when setting up the 2D Area effect to ensure it functions as intended without depth effects.

## Arrow (Distance)



The Arrow (Distance) effect draws a straight arrow with an optional distance measurement.

This effect requires [Calibration](#)<sup>[34]</sup> and a [Keyer](#)<sup>[32]</sup>.



*Arrow (Distance) Effect*

### To use the Arrow (Distance) effect:

1. Add an Arrow (Distance) effect to the project.
2. In the property sheet, select **Arrow** tab, and use the **Point To Goal** property to measure the distance between a player and the goal as follows:
  - a. Left-click and drag the middle of the arrow to position it.
  - b. Drag the end points to change the direction and length of the arrow.
  - c. Press the Shift key and scroll to re-size the arrow.Alternatively, you can press and hold the **Ctrl** key and scroll to resize.
3. Use the **Opacity** slider to set the opacity of the arrow.
4. Use the **Keyed** checkbox to toggle the use of the Key for the effect, applying it with or without the key as needed.
5. Use the **Link Head/Tail To Track**<sup>[232]</sup> drop-downs to link the head and the tail with a specific [track](#)<sup>[232]</sup>.
6. From the **Transition** drop-down, select the desired transition style for the effect.
  - **Animate** - draws the arrow from zero to the given height
  - **Mix** - fades in the arrow with no change in height.
7. Adjust the style and shape of the arrow as desired using the options in the **Arrow Style** and **Arrow Shape** sections.

★ When using these parameters, the order of effects in the project matters. In order to prevent 3D collision and depth problems the arrows should be placed at the bottom of the project and a region tool should be defined at this time code.

8. Add and configure the measurement text for the Height Arrow graphic effect as follows (optional):
  - a. Select the **Measurements** tab and select the desired unit for the distance measurement from the **Distance Measure** dropdown menu—options include meters, yards, feet, or none (to not display the measurement).
  - b. Use the **Show Sub-units** and **Show Measurement Unit** checkboxes to determine visibility of sub-units and the measurement unit.
  - c. Enter text details:
    - Prefix Text:** Enter any text to appear before the measurement.
    - Suffix Text:** Enter any text to appear after the measurement.
    - Measurement Unit Text:** Specify the text for the measurement unit.
  - d. Select the **Text** tab to optionally configure text settings such as opacity, size, orientation, and text style, including shadow options.

## Arrow (Freehand)



The Arrow (Freehand) effect is used to draw 3D freehand arrows and lines on the pitch.

This effect requires [Calibration](#) <sup>[34]</sup> and a [Keyer](#). <sup>[32]</sup>

★ The requirements for Calibration and Keying do not apply when the **2D** property is enabled, as the effect is then rendered in two-dimensional format without depth cues.



*Arrow (Freehand) Effect*

The freehand arrow effect draws a curved arrow along a spline. More than one arrow can be drawn onto the pitch by dragging out a new curve. All arrows must share the same properties however, such as color and style.

### To use the Arrow (Freehand) effect:

1. Add an Arrow (Freehand) effect to the project.
2. Left-click on a control handle to select it and drag to adjust the shape of the arrow.
3. With a control handle selected, scroll the mouse wheel to change the height of the arrow at that control point.

#### OR

With no control handle selected, scroll the mouse wheel to change the width of the arrow.

4. From the property sheet, adjust the opacity using the **Opacity** slider to set the desired transparency.
5. Use the **Keyed** checkbox to toggle the use of the Key for the effect, applying it with or without the key as needed.
6. Select the **2D** checkbox to render the effect in two-dimensional format as needed.
7. From the **Transition** drop-down menu, select the desired transition style for the effect.
  - **Animate** - draws the arrow from zero to the given height
  - **Mix** - fades in the arrow with no change in height.
8. Adjust the style and shape of the arrow as desired using the options in the **Arrow Style** and **Arrow Shape** sections.
9. Use the **Left/Right** arrows on the keyboard to cycle through the set of freehand arrows to make adjustments on each one.

**To delete an arrow:**

- Press the **Backspace** key to delete the last freehand arrow drawn.

**To delete a control handle:**

- Click on a control handle and press the **Backspace** key to delete the handle.

## Arrow (Height)



The Arrow (Height) effect is used to draw a vertical arrow to illustrate height.

This effect requires [Calibration](#)<sup>34</sup> and a [Keyer](#)<sup>32</sup>.

The Arrow (Height) effect is particularly useful for a line-out in rugby when a player is hoisted into the air to intercept the ball (see the image below).



*Arrow (Height) Effect*

### To use the Arrow (Height) effect:

1. Add an Arrow (Height) effect to the project.
2. Left-click to place the arrow on the ball and while pressing the mouse button, drag the arrow to the ground.

#### OR

Click on the ground beneath the ball and then scroll the mouse wheel forward.

3. Use the cursor keys to reposition the arrow base more accurately.
4. In the **Arrow** tab, use the **Arrow Height** field to enter a value for the height.
5. Adjust the opacity using the **Opacity** slider to set the desired transparency.
6. Select the **Point Down** checkbox if you want to reverse the arrow direction, fixing the top arrow and extending the bottom arrow downward during playback.
7. Use the **Keyed** checkbox to toggle the use of the Key for the effect, applying it with or without the key as needed.
8. From the **Transition** drop-down menu, select the desired transition style for the effect.
  - **Animate** - draws the arrow from zero to the given height
  - **Mix** - fades in the arrow with no change in height.
9. Adjust the style and shape of the arrow as desired using the options in the **Arrow Style** and **Arrow Shape** sections.
10. Add and configure the measurement text for the Height Arrow graphic effect as follows (optional):
  - a. Select the **Measurements** tab and select the desired unit for the distance measurement from the **Distance Measure** dropdown menu—options include meters, yards, feet, or none (to not display the measurement).

- b. Use the **Show Sub-units** and **Show Measurement Unit** checkboxes to determine visibility of sub-units and the measurement unit.
- c. Enter text details:
  - Prefix Text:** Enter any text to appear before the measurement.
  - Suffix Text:** Enter any text to appear after the measurement.
  - Measurement Unit Text:** Specify the text for the measurement unit.
- d. Select the **Text** tab to optionally configure text settings such as opacity, size, orientation, and text style, including shadow options.

## Arrow (Straight)



The Arrow (Straight) effect is used to draw a straight arrow.

This effect requires [Calibration](#)<sup>[34]</sup> and a [Keyer](#)<sup>[32]</sup>.

★ The requirements for Calibration and Keying do not apply when the **2D** property is enabled, as the effect is then rendered in two-dimensional format without depth cues.

The freehand arrow effect draws a straight arrow along a defined path. Multiple arrows can be drawn onto the pitch by dragging out new lines.



*Arrow (Height) Effect*

### To use the Arrow (Straight) effect:

1. Add an Arrow (Straight) effect to the project.
2. Left-click on a control handle to select it and drag to adjust the length and position of the arrow.
3. From the property sheet, use the **Point to Goal** drop-down to define how the effect points towards a goal area or target on the field.
4. Use the **Keyed** checkbox to toggle the use of the Key for the effect, applying it with or without the key as needed.
5. Select the **2D** checkbox to render the effect in two-dimensional format as needed.
6. Use the **Link Head/Tail To Track** drop-downs to link the head and the tail of the arrow with a specific [track](#)<sup>[232]</sup>.
7. From the **Transition** drop-down menu, select the desired transition style for the effect.
  - **Animate** - draws the arrow from zero to the given height
  - **Mix** - fades in the arrow with no change in height.
8. Adjust the style and shape of the arrow as desired using the options in the **Arrow Style** and **Arrow Shape** sections.

### To delete an arrow:

- Press the **Backspace** key to delete the last arrow drawn.

# Caption Track



The Caption Track effect tracks a player with a text caption or an image.

This effect requires [Calibration](#) [34] and a [Keyer](#) [32].

The Arrow (Height) effect is particularly useful for a line-out in rugby when a player is hoisted into the air to intercept the ball (see the image below).

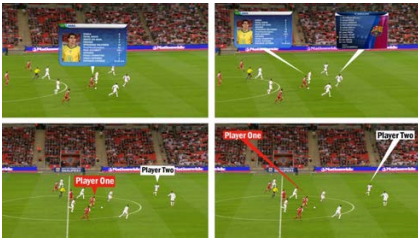

*Caption Track Effect*

## To create a Caption Track (Method 1 - Auto-Tracking):

1. Add a Caption Track effect to the project.  
A blue rectangle appears around each player.
2. Click the middle mouse button in the rectangle surrounding the player you want to track.  
The **Auto Track** mode is applied.
3. Play the video to create a track.
4. Press the > key to advance the video in intervals (optional).

## To create a Caption Track (Method 2 - Manual Tracking with Intervals):

1. Add a Caption Track effect to the project.
2. In the property sheet, press the **Manual Interval** mode button.
3. Then use the **Interval** slider to adjust the length of the intervals.
4. In the **Caption** tab, in the **Caption Text** field, enter the text you want to appear in the caption.

### OR

- From the **Preset Names** drop-down, select the name of the player you want to track.
5. Edit the properties of the caption, text and caption line, as necessary.
  6. Left-click under the feet of the player you want to track.  
The video will play to the next interval automatically.
  7. Left-click again under the feet of the player you are tracking and continue until the track is complete.

### To use the Caption Track effect:

1. Create a caption track using one of the above methods.
2. In the property sheet, use the **Ground Offset** property to determine how far off the ground the caption should appear.

Use the mouse wheel to further adjust the ground offset of the caption.

Generally, this will be the player's height. The default is 2 m.

3. Left-click to position a point on the track.

Make sure the arrow is pointing at the player's head.

4. In the property sheet, from the **Style** property, select whether to use a text caption or an image caption.

#### For an image:

- a. In the Image section of the property sheet, select an image to follow the player.

The list of images is the same as that for the Logo 123 effect.

- b. Adjust the **Image Height** property to adjust the height of the image on screen.

#### For text:

- In the **Text** property, enter the text you want to display and select the **Show text** checkbox.

5. To make the caption appear in a fixed position on screen, instead of following the player along the track, select the **Fixed** position checkbox.

6. Right-click to position the caption on screen.

#### OR

Enter an **X** and **Y** pixel coordinate in the **Screen X** position and **Screen Y** position property fields.

The (0, 0) coordinate is at the top-left corner of the screen.

7. Scale the image by entering a value in the **Fixed** position image scale property field – for example, entering 0.5 will show the image at 50% of its normal size.

For fixed position image captions, the default behavior is to show the image at actual size, pixel for pixel.

# Circle



The Circle effect draws a circle or ellipse onto the pitch. The circle can track over time, changing position and shape as required and could be used to illustrate a free kick zone.

This effect requires [Calibration](#) <sup>[34]</sup> and a [Keyer](#) <sup>[32]</sup>.

★ The requirements for Calibration and Keying do not apply when the **2D** property is enabled, as the effect is then rendered in two-dimensional format without depth cues.



*Circle Effect*

## To use the Circle effect:

1. Add a Circle effect to the project.  
A 10 yard (9.14 m) circle is placed at the centre of the screen.
2. Click where you want the center of the circle to be.
3. Right-click the center control handle to drag the circle to a different position.  
Alternatively, you can also press and hold the Shift key and use the arrow keys to reposition the effect.
4. Click and drag the bottom-right control handle to adjust the radius of the circle.  
Alternatively, you can scroll the mouse wheel to adjust the radius.

### OR

In the property sheet, in the **Radius** property, enter a new value.

## To create an ellipse:

1. Add a Circle effect to the project.
2. In the property sheet, deselect the Constrain property.
3. Click and drag the bottom-right control handle to draw an ellipse.

### To track a circle or ellipse:

1. Create the circle or ellipse.
2. Move the video to another point.
3. Left-click to add a new keyframe.
4. The circle will now track between the center points.
5. Click and drag the bottom-right control handle to adjust the radius.

A number of the circle properties are described in the following table.

Property	Description
<b>Circle Properties</b>	
<b>Radius (m)</b>	The radius of the circle, expressed in metres.
<b>Height</b>	The height at which the circle appears above the surface of the pitch.
<b>Constrain</b>	Select to draw an ellipse rather than a circle.
<b>Keyed</b>	Use the <b>Keyed</b> checkbox to toggle the use of the Key for the effect, applying it with or without the key as needed.
<b>2D</b>	Select the <b>2D</b> checkbox to render the effect in two-dimensional format.
<b>Transition</b>	The in/out transition of the circle, either <b>Animate</b> or <b>Mix</b> .
<b>Area Style</b>	The style of the circle, e. g., <b>Solid, Patterned, 3D</b> .
<b>Area color</b>	The color of the area of the circle.
<b>Area Opacity</b>	Move the slider to increase or decrease the transparency of the area of the circle.
<b>Border Properties</b>	
<b>Border Style</b>	The style of the border, e. g., <b>Line, Flare, Glow, 3D</b> .
<b>Border color</b>	The color of the outer line of the circle.
<b>Border Width</b>	Move the slider to increase or decrease the transparency of the width of the border.
<b>Wall Height</b>	The height of the border (making it look like a wall around the circle).
<b>Dashes</b>	Move the slider to break up the border line into dashes.
<b>Animation</b>	Move the slider to animate the border, from 0 (no animation) to <b>100</b> (a very fast animation).

### To delete a control handle:

- Press the **Backspace** button to delete the currently selected or last control handle.

## Circle Effect for Piero Touch

This section outlines how to use the effect in Piero Touch.

### To configure the Circle effect for Piero Touch:

1. In PIERO, select the **Touch** button to enable Touch mode.
2. Add a Circle effect to the project.
3. Left-click and hold on the video window where you want the circle to appear.
4. Drag outward to enlarge or inward to reduce the size of the circle to your desired dimensions.

Alternatively, you can enter a new value in the **Radius** property on the property sheet to adjust the size of the circle.

### To use the Circle effect in Piero Touch:

1. Add a 2D Circle effect to the project.  
Initially, no circle will be visible on the screen.
2. Tap on the video window where you want the circle to appear and hold your finger on the screen.  
A circle will form at this location.
3. Without lifting your finger, drag outward to enlarge or inward to reduce the size of the circle to your desired dimensions.
4. Release your finger once you are satisfied with the size of the circle.

Lifting your finger completes the drawing process, and any subsequent taps will start a new circle.

## 2D Circle Effect



The 2D Circle effect draws a 2D circle onto the pitch in Touch mode.

The procedure for using and configuring the 2D Circle effect in Touch follows the same steps as the standard Circle effect in Touch mode. The primary difference lies in the default settings: for the 2D Circle effect, the **2D** checkbox is selected by default to maintain a flat, two-dimensional appearance, while the **Keyed** checkbox is not selected. This distinction is important for users to note when setting up the 2D effect to ensure it functions as intended without depth effects.

# Counter



The Counter effect provides an easy way to count passes, steps, etc.

This effect requires [Calibration](#)<sup>34</sup> and a [Keyer](#)<sup>32</sup>.



*Counter Effect Examples*

Counting markers will count inside a pause and on running video.

## To use the Counter effect:

1. Add a Counter effect to the project.
  2. In the property sheet, in the **Counter** tab, select a **Counter Mode** and configure the **Counter's** standard properties.
  3. In the **Marker** tab, configure the standard **Marker** properties or in the **Marker Style**, select **NONE** for no marker.
  4. In the **Text** tab, configure the standard **Text**, **Text Background**, and **Text Shadow** properties.
  5. Click on the screen immediately after each pass to insert a **Counter**.
- ★ Use the **VTR Half-Speed** button to play the video in slow motion to assist in adding Counters after each pass.



*VTR Half-Speed Button*

# Crosshair Marker



The 2D Crosshair Marker effect adds a cross-hair marker in Touch mode only.

This effect requires [Calibration](#)<sup>[34]</sup> and a [Keyer](#)<sup>[32]</sup>.

★ The requirements for Calibration and Keying do not apply when the **2D** property is enabled, as the effect is then rendered in two-dimensional format without depth cues.



*Crosshair Marker Effect*

## To configure the Crosshair Marker effect for Piero Touch:

1. In PIERO, select the **Touch** button to enable Touch mode.
2. Add a Crosshair Marker effect to the project.
3. Left-click on the pitch where you want the marker to appear.
4. In the property sheet, configure the effect settings:
  - **Crosshair Image:** Choose a predefined style from the dropdown menu to change the visual style of the crosshair.
  - **Crosshair Square:** Check this box if you wish to display the crosshair in a square format.
  - **Keyed:** Use the **Keyed** checkbox to toggle the use of the Key for the effect, applying it with or without the key as needed (disabled as default).
  - **2D:** Check this box to render the effect in two-dimensional format as needed (enabled as default).
  - **Pulsing:** Enable pulsing to add a dynamic, pulsating effect to the crosshair.
  - **Colour:** Select the checkbox to enable the color adjustment option and choose the desired color.
  - **Shadow Opacity:** Adjust the slider to set the opacity of the crosshair's shadow, enhancing visibility against various backgrounds.
  - **Width:** Move the slider to adjust the width of the crosshair lines.
  - **Length:** Move the slider to adjust the length of the crosshair lines.
  - **Spin Speed:** Adjust the spin speed to control the rotation speed of the crosshair.

**To use the Cross Hair Marker effect in Piero Touch:**

1. Add a 2D Crosshair Marker effect to the project.
2. Tap on the video window where you want the marker to appear.
3. Tap again to move the marker to a different location.

This moves the marker; it does not add another marker.

# Curved Arrow



The Curved Arrow effect draws a curved arrow on the pitch.

This effect requires [Calibration](#) <sup>34</sup>.



*Curved Arrow Effect*

The curved arrow effect draws a curved arrow along a spline. More than one arrow can be drawn onto the pitch by dragging out a new curve.

## To use the Curved Arrow effect:

1. Add a **Curved Arrow** effect to the project.  
An arrow with three control handles appears on the video.
2. Left-click on a control handle to select it and drag to adjust the shape of the arrow.
3. With the middle control handle selected, scroll the mouse wheel to change the height of the arrow at that control point.
4. From the property sheet, adjust the **Mid Height Scale**, **Opacity**, and **Transition** properties of the effect.
5. In the **Arrow Style** section, adjust the arrow's color, gradient, transparency, and other stylistic properties.
6. In the **Arrow Shape** section, modify the size, width, thickness, and other shape attributes to refine the arrow's appearance.
7. In the **Transition Settings** section, adjust the **In Delay** and **Out Delay** sliders to control when the effect appears and disappears.

## Direction of Play



The Direction of Play effect displays the direction in which a team will play when they get the ball from a scrum. It is available for Rugby only.

This effect requires [Calibration](#) <sup>34</sup> and a [Keyer](#) <sup>32</sup>.



Type: Area



Type: 10 m Strip



Type: Strip

*Direction of Play Effect*

### To use the Direction of Play effect:

1. Add a Direction of Play effect to the project.
2. Click at the feet of the player with the ball.
3. Use the left/right arrow keys to position the area on the side of the line where the ball will be played.
4. In the property sheet, configure the area style.

## Distance to Goal



The Distance to Goal effect draws an arrow from a given point to the goal and includes the distance measurement. It is available in Live mode for Rugby only.

This effect requires [Calibration](#)<sup>[34]</sup> and a [Keyer](#)<sup>[32]</sup>.

★ The requirements for Calibration and Keying do not apply when the **2D** property is enabled, as the effect is then rendered in two-dimensional format without depth cues.



*Distance to Goal Effect*

### To use the Distance to Goal effect:

1. Add a Distance to Goal effect to the project.

The Distance to Goal arrow automatically points to the goal on the side of the pitch that the camera is oriented towards.

2. Modify the arrow using the following mouse and key operations:

- Left-click to position the start of the arrow.
- Left-click and drag to point the arrow to the desired goal.
- Right-click a position to add the distance text.
- Press the **Shift** key and scroll to re-size the arrow width and the distance text.
- Press **CTRL** or **C** to re-size the distance text only.

3. In the **Arrow** tab, select (default) or deselect the **Keyed** checkbox to toggle the use of the RGB Key for the effect, applying it with or without the key as needed.

### To use the Distance to Goal effect on a Touch screen:

1. Add a Distance to Goal effect to the project.

The Distance to Goal arrow automatically points to the goal on the side of the pitch that the camera is oriented towards.

2. Touch the screen where you want to start the arrow and drag it in the direction of the desired goal.

Other useful effect properties are described in the table below.

Property	Description
<b>Point to Goal</b>	Direct the arc towards the goal.
<b>Opacity</b>	Adjusts the opacity level.
<b>Keyed</b>	Use the <b>Keyed</b> checkbox to toggle the use of the Key for the effect, applying it with or without the key as needed.
<b>Link Head/Tail to Track</b>	Associate the head/tail with a specific track.
<b>2D</b>	Select the <b>2D</b> checkbox to render the effect in two-dimensional format.
<b>Transition</b>	From the Transition drop-down, select the desired transition style for the effect. <ul style="list-style-type: none"> <li>• <b>Animate</b> - draws the arrow from zero to the given height</li> <li>• <b>Mix</b> - fades in the arrow with no change in height.</li> </ul>
<b>Arrow Style</b>	Adjust the style of the arrow as desired using the options in the <b>Arrow Style</b> section of the <b>Arrow</b> tab.
<b>Arrow Shape</b>	Adjust the shape of the arrow as desired using the options in the <b>Arrow Shape</b> section of the <b>Arrow</b> tab.
<b>Distance Measure</b>	Select the <b>Measurements</b> tab and select the desired unit for the distance measurement from the <b>Distance Measure</b> dropdown menu—options include meters, yards, feet, or none (to not display the measurement).

## Down and Distance



The Down and Distance effect is used for American Football to display the first down line and the line of scrimmage, as well as a distance marker and timer. This section addresses the use of the effect only. For details on the setup procedures required to utilize the effect, please refer to the *PIERO Live User Guide*.

This effect requires [Calibration](#) <sup>34</sup> and a [Keyer](#) <sup>32</sup>.

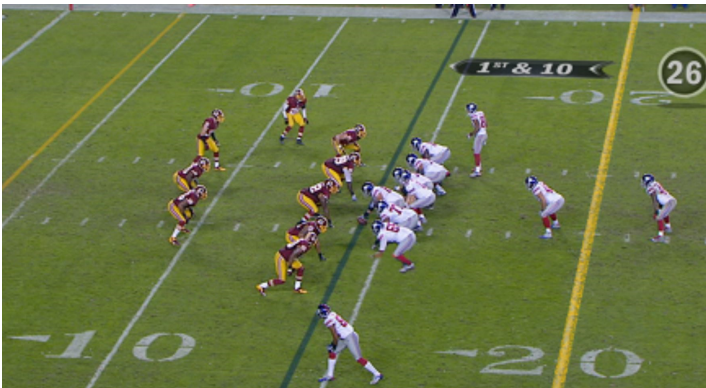

### Down and Distance Effect

Once keyers and calibrations have been set up, the **Down and Distance** effect can be added.

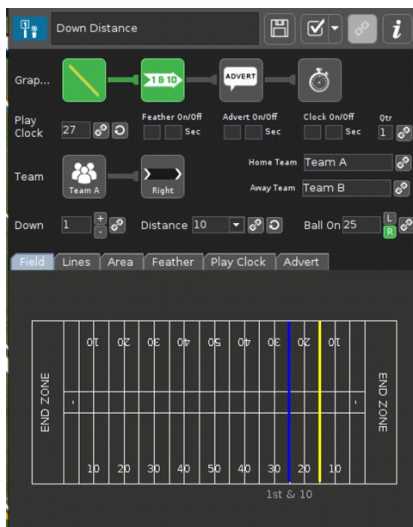

### Down and Distance Property Sheet

The property sheet consists of:

- Four graphic buttons representing the down lines, feather, advert and play clock in that order. These can be toggled where green means active. Note the inter-connecting line icons which can also be toggled to allow the parent graphic to automatically control the visibility of the child graphic.
- Beneath this are the current play clock settings and on/off triggers. The triggers allow each graphic (feather, play clock, or advert) to be automatically animated on or off at the inputted play clock seconds value. See [Animating Graphics On/Off](#) <sup>161</sup> for information on how to animate these graphics.
- Current team in play and play direction. Note these can be connected if desired.

- Current down, distance and ball yardage (sometimes called “ball on”).
- Beneath this are further property tabs which allow control of line styles, area styles, feather, play clock and adverts.
- At the bottom of the property sheet is an overview of the field showing the current position of first down and scrimmage lines.

## Configuration

Before play, configure the following settings for the Down and Distance effect:

- Enter team names into the home/away text fields of the property sheet. These can be [DataLinqed](#). 
- Set the desired line style and colors using the “Lines” tab on the property sheet.
- Set the desired area style (which is drawn between the scrimmage line and the first down line) by using the **Area** tab of the property sheet.
- Set the home/away feather graphics by using the **Feather** tab on the property sheet. Feathers can be images (PNG recommended) or TGA sequences.
- Set the home/away play clock graphic by using the **Play Clock** tab on the property sheet.
- Configure the adverts in the **Advert** tab. Adverts can be images (recommended PNG files) or movies (TGA folders). Adverts can be configured per down.

★ Once the down and distance effect is configured, save the effect.

## DataLinq

DataLinq can be used to automatically drive the down and distance properties using a DataLinq connection to the stadium score board. Attempting to drive the down and distance manually is possible but will need a lot of concentration! There are seven parameters that can be connected to the relevant DataLinq score board fields. They are: down, distance, yardage (or ball-on) play clock, quarter, home team name and away team name.

### To use DataLinq:

1. Connect using the **PIERO Settings** tab.
2. Then click on one of the chain icons in the property sheet.  
A popup window will appear.

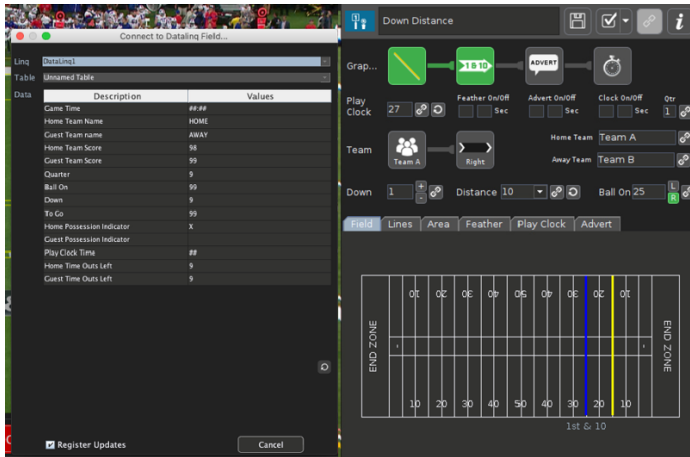

*DataLinq Pop-Up Window*

3. Select the relevant cell in the table that matches with the property you wish to link to in the property sheet.

For example, to connect the **Down** property, select the second column table cell that has a matching down value. Do not select the text description cell in the first column – it must be the number value in the second column.

Unfortunately, scoreboards don't generally know which side of the field play is currently on. In American Football, the ball yardage of 50 to 0 appears on both sides of the field. For this reason the operator must check which side of the field play is currently on and manually set the left/right buttons accordingly in the down and distance property sheet:



*Down and Distance Property Sheet - Left / Right Buttons*

### Shortcut Keys

There are a number of shortcut keys available for the down and distance effect the most important of which are summarised below. A complete list of hot keys and mouse usage are available in the "i" help icon at the top right of the property sheet.

Hot key	Behaviour
<b>2 Digit numbers</b>	Typing two digits can be used to quickly choose the current ball on yardage. For example typing "21" will choose the 21st yard.
<b>l</b>	Selects the left side of the field
<b>r</b>	Selects the right side of the field
<b>,</b>	Increase down number
<b>.</b>	Decrease down number
<b>d</b>	Resets to 1st down and 10 yards

## Live Operation

Live operational use of the down & distance effect (with 3 cameras) should look like the following:

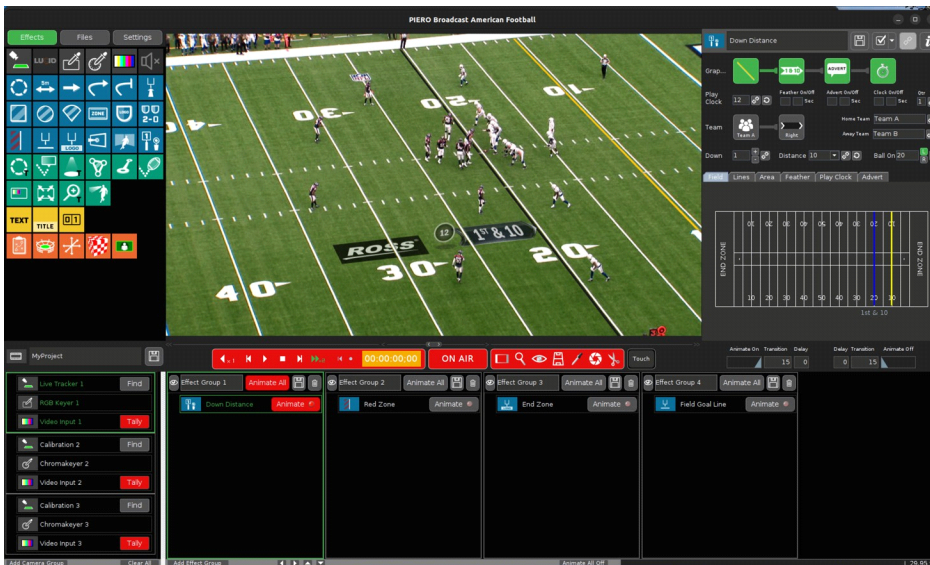

### Down and Distance - Live Operation

Steps to perform for each play:

1. Ensure that you are "ON AIR" with the preview and field control buttons active.

This will allow you to preview the calibration and graphics before you animate on anything.



#### Active On Air and Field Control Buttons

2. Select the current active camera (center, left or right) by clicking on the relevant camera group that you previously setup on the bottom right of the PIERO UI.

★ Hot keys are available to do this: "F1" will select the first camera, "F2" the second camera and "F3" the third etc.

3. Ensure the calibration is correct using the yellow field lines as a visual guide.
4. If it is incorrect then use the calibration find procedures in the *PIERO Live User Guide*.

The F1, F2 or F3 hotkeys will automatically select the calibration effect for fast workflow use.

5. Ensure the keying is correct using the eye dropper tool (on the left of the field lines tool) to show the current key.

★ Hot keys **Shift+F1**, **Shift+F2** etc. can be used to quickly select the relevant keyer for camera 1, 2 etc.

6. Ensure the down & distance effect is positioned correctly and showing the correct information.
  - Use the "eye" preview tool to show the effect in the video window to ensure the down and distance effect is positioned correctly and showing the correct information.
  - Using the preview tool will not send the effect to air on the SDI output.

- Use the hotkey F8 to automatically select the down and distance effect.

7. If the calibration and graphic look OK then you're ready to animate on the down & distance effect.

Use the animate button to do this (or press the space bar if the effect is selected) – it will go red when active.



*Animate Button*

8. When play has completed, animate off the graphic by pressing the "Animate" button again (or press space again).
9. As each play restarts repeat steps 2 to 6.

### Shortcut Keys

To speed up live operation a number of hot keys are available the most important are shown below. A complete list of available hot keys in the live UI can be seen using the "Shortcuts" button in the general settings of the PIERO UI. Hot keys specific for each effect can be seen using the "i" icon in the effect property sheet.

Hot key	Behaviour
<b>F1, F2, F3, etc.</b>	Selects the camera group and calibration for camera 1, 2, 3 etc.
<b>Shift+F1, Shift+F2, etc.</b>	Selects the keyer for camera 1, 2, 3 etc
<b>F8</b>	Selects Down and Distance effect (or if D&D effect not found, then the first effect in effect group 1).
<b>F9</b>	Toggles key overlay.
<b>F10</b>	Executes a "Find" on the current calibration.
<b>&lt;Space&gt;</b>	Animates on/off the selected effect.
<b>'d'</b>	Selects the nearest calibration click-find point to the current ball-on yardage from the down and distance effect (only when calibration selected).

# Dynamic Formation



The Dynamic Formation effect shows the formations of players or how a group of players works together. These formations can be visualized during a pause or over a period of time, where the area or line will dynamically change.

This effect requires [Calibration](#)<sup>34</sup> and a [Keyer](#)<sup>32</sup>.

★ The requirements for Calibration and Keying do not apply when the **2D** property is enabled, as the effect is then rendered in two-dimensional format without depth cues.



Example 1



Example 2



Example 3

*Dynamic Formation Effect*

## To create a Dynamic Formation (Method 1 - Auto-Tracking):

1. Add a Dynamic Formation effect to the project.  
A blue rectangle appears around each player.
2. Click the middle mouse button in the rectangle surrounding each player you want to track.  
The **Auto Track** mode is applied.
3. Play the video to create a track.
4. Press the > key to advance the video in intervals (optional).
5. Repeat Steps 2 and 3 until the tracks are complete.

## To create a Dynamic Formation (Method 2 - Manual Tracking with Intervals):

1. Add a Dynamic Formation effect to the project.
2. Left-click under the feet of the players you wish to track.
3. Press the > keyboard key to move the video to the next interval.
4. Left-click under the feet of the players you are tracking, in the same order as the first time.  
Use the numbers next to the track handles to help you remember the order of the players.
5. Press the > key to play the video to the next interval.
6. Repeat Steps 3 and 4 until the tracks are complete.

Other useful effect properties are described in the table below.

Property	Description
<b>Please Add Tracks</b>	Select an existing track from the drop-down list to add it to the project.
<b>Increment Row</b>	When checked, each track is affected by any changes. When not checked, you can work on one Dynamic Formation track at a time without continuing the other tracks. Default is checked.
<b>Formation Shape</b> (Properties Tab)	Defines the shape of the formation. Options are: <ul style="list-style-type: none"> <li>• Area</li> <li>• Indented Area</li> <li>• Line</li> <li>• Multiple Text Segments</li> <li>• Ordered Line (vertical line across the width of the pitch, ignoring the tracks order)</li> <li>• Average Line</li> </ul>
<b>Keyed</b>	Use the <b>Keyed</b> checkbox to toggle the use of the Key for the effect, applying it with or without the key as needed.
<b>2D</b>	Select the <b>2D</b> checkbox to render the effect in two-dimensional format.
<b>Area Style</b>	From the drop-down menu, select the desired style for the area. When selected in the <b>Area</b> tab, the standard area properties will be displayed
<b>Line Style</b>	When the <b>Formation Shape</b> is any of the line options, in the <b>Borders</b> tab, from the <b>Line Style</b> drop-down, you can select from multiple line styles, <b>3D Border</b> , <b>Line</b> , <b>Chalk</b> , etc.
<b>Marker Style</b>	Select to enable markers. When selected in the <b>Marker</b> tab, the standard marker properties will be displayed.
<b>Trail Style</b>	From the drop-down menu, select the desired style for the trail. When selected in the <b>Trail</b> tab, the standard trail properties will be displayed.
<b>Text Measure</b>	When selected in the <b>Measurements</b> tab, displays the length of the total line or the area of the defined shape or in the case of the <b>Multiple Text Segments</b> shape, the length of each segment.

**To undo:**

1. Press **Backspace** to remove the last point added.
2. Use the cross icon in the track table of the Dynamic Formation property sheet to remove an entire track.

**To edit a track:**

- Select a track from the list of Dynamic Formation tracks to edit it.  
The entire track and the control handles are displayed.

## Freehand 2D Line



The Freehand 2D Line effect draws a freehand line as if you are drawing directly on the screen.

This effect requires [Calibration](#)<sup>34</sup> and a [Keyer](#)<sup>32</sup>.

The Freehand 2D Line effect draws a line over the video image that is not tied-to-pitch but is drawn as if drawing on the screen. It is the graphical equivalent of drawing with a pen over the video image. The lines are not moved when the camera moves and therefore are always drawn over the video image regardless of the changes within the video. The players will never appear over the lines.

The effect can be used to freely draw over any scene. The user is free to write text, circle objects, draw arrows etc.

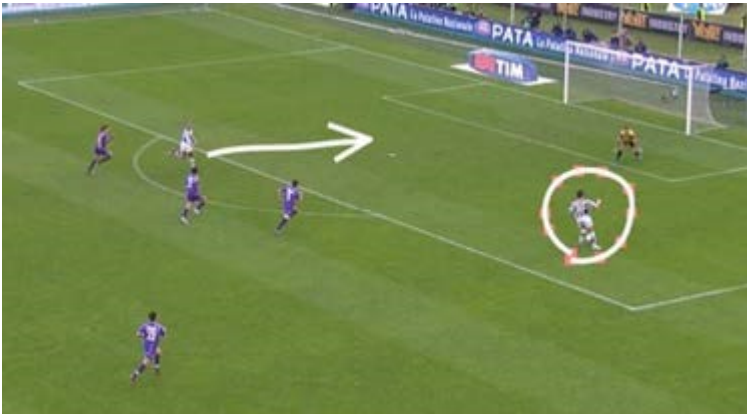

*Freehand Line 2D Effect*

### To use the Freehand 2D Line effect:

1. Add a Freehand 2D Line effect to the project.
2. Click on the screen and press **Shift** while dragging to draw a straight line.
3. Drag the red control points to adjust the shape of the most recently-drawn line.
4. Press the **Delete** key to delete the last-drawn line.

# Goal Zone

[Keying](#) <sup>32</sup>



The Goal Zone effect allows you to color and add text to different zones of a goal. Applies to Aussie Rules only.

This effect requires [Calibration](#) <sup>34</sup> and a [Keyer](#) <sup>32</sup>.



*Goal Zone Effect*

## To use the Goal Zone effect:

1. Add a Goal Zone effect to the project.
2. In the effect property sheet, select the **Left Goal?** checkbox if you are illustrating the goal zone for the left goal or clear the checkbox if you are illustrating the right goal.
3. From the **Zone Style** drop-down, select the style for the zones (the illustration above uses the **Color Wall** style).
4. In the **Goal Zone** sections, select the color and text that you want for each zone.
5. Left-click the square handles at the base of the zones to adjust their position to match the goal posts.
6. In the **Text** tab, adjust the properties of the text.

# Laser Eye



The Laser Eye effect displays the player's field of view.

This effect requires [Calibration](#)<sup>[34]</sup> and a [Keyer](#)<sup>[32]</sup>.

★ The requirements for Calibration and Keying do not apply when the **2D** property is enabled, as the effect is then rendered in two-dimensional format without depth cues.

There are three laser styles available:

- **Coloured Laser Eye**
- **Textured Laser Eye**
- **Layered Laser Eye**

Unlike other effects in PIERO, the Laser Eye is positioned at head level.

## To use the Laser Eye effect:

1. Add a **Laser Eye** effect to the project.
2. Left-click to place the effect in the video and right-click to another position to create the effect.
3. Click and drag either end of the effect to adjust the position of the effect.
4. Scroll the mouse wheel to adjust the width of the effect.
5. In the **Properties** tab, select the **2D** checkbox to render the effect in two-dimensional format as needed.
6. Configure the additional style and animation settings as required (color, style, opacity, width, height, etc.)

## To use the Laser Eye effect with an unconstrained position:

1. In the **Properties** tab, uncheck the **Constrained** checkbox.
2. Position both ends of the arc manually.

This is useful when using the effect without a calibration on close ups or trying to adjust to a specific scenario (goal posts etc.).

## Link to Track

You can link the laser eye to two tracks with different effects on each.

## To link the Laser Eye to two tracks:

1. Track players using a different effect.
2. Link the origin to one track.
3. Link the end point to another track or position in a fixed position.

# Laser Wall



The Laser Wall effect displays a laser wall that cuts across the pitch.

This effect requires [Calibration](#)<sup>[34]</sup> and a [Keyer](#)<sup>[32]</sup>.

The Laser Wall effect can be used to demonstrate an offside, or an incident over the line, by graphically cutting the pitch into two. The wall will graphically intersect any other PIERO graphics placed on the pitch, including 3D players the 3D ball effect and billboarded virtual video players (see [Virtual Stadium](#)<sup>[253]</sup>).



*Laser Wall Effect*

## To use the Laser Wall effect:

1. Add a Laser Wall effect to the project.
2. Left-click at the point on the pitch where you want the wall to appear.
3. In the **Offside** tab, use the **Keyed** checkbox to toggle the use of the Key for the effect, applying it with or without the key as needed.
4. From the **Transition** drop-down, select the desired transition style for the effect.
  - **Animate** - draws the arrow from zero to the given height.
  - **Mix** - fades in the arrow with no change in height.
5. Adjust the **Wall Height** and **Border Width** of the wall.

The laser wall **Border Width** defaults to the pitch width (usually 68 m).

To adjust the width to fit the goalmouth, change the value of the **Border Width** to the goalmouth width (7.32 m).

The **Wall Height** defaults to the goalmouth height (2.44 m).

6. In the **Line Style** section of the **Offside** tab, configure the line style settings as desired.
7. In the Area tab, from the **Area Style** drop-down menu, select the desired style for the area.  
When selected in the Area tab, the standard area properties will be displayed.

## Logo

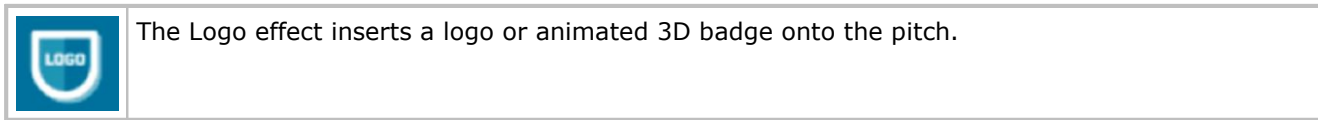

This effect requires [Calibration](#) <sup>34</sup> and a [Keyer](#) <sup>32</sup>.

★ The requirements for Calibration and Keying do not apply when the **2D** property is enabled, as the effect is then rendered in two-dimensional format without depth cues.



Logo Effect

### To use the Logo effect:

1. Add a Logo effect to the project.
2. In the property sheet, select a logo from the drop-down list next to the **Logo** property.  
See the *PIERO Tech Guide* for more details on importing logos and animated badges.
3. Left-click and drag the corners to re-size the logo.
4. Left-click and drag the middle of the logo to reposition it.
5. Scroll the mouse wheel to change the orientation of the logo.
6. In the property sheet, select the **Properties** tab and adjust the logo properties as needed:
  - **Logo**: Choose the logo file.
  - **Logo Opacity**: Adjusts the opacity level.
  - **Logo Brightness**: Adjusts the brightness.
  - **Logo Contrast**: Adjusts the contrast.
  - **Logo Saturation**: Adjusts the saturation.
  - **Soften Edge**: Softens the edges of the logo.
  - **Shadow Opacity**: Adjusts the shadow's opacity.

- **Keyed:** Use the checkbox to toggle the use of the Key for the effect, applying it with or without the key as needed.
  - **2D:** Select the checkbox to render the effect in two-dimensional format as needed.
  - **Billboard:** Sets the logo to display as a billboard (i.e., stood vertically in the air facing the camera).
  - **Full Screen:** Expands the logo to full screen.
  - **Filtered:** Apply a filter.
  - **Link To Track:** Links the logo to a specific [track](#) <sup>232</sup>.
  - **Transition:** Choose the transition effect.
7. Select the **Position** tab to adjust the position and curve settings as needed.
  8. Select the **Animation** tab to configure animation options as needed:
    - **Spin Animation Speed:** Define the speed of the the logo's rotation.
    - **Spin Flip Image:** Enable flipping during spin.
    - **Animation Loops:** Set the number of loops.
    - **Rippling:** Add a rippling effect.

# Magnifier



The Magnifier effect is used to highlight or magnify an area of the screen.

This effect requires [Calibration](#) <sup>34</sup> and a [Keyer](#) <sup>32</sup>.



*Magnifier Effect*

## To use the Magnifier effect:

1. Add a Magnifier effect to the project.
2. In the property sheet, configure the **Magnification**, **Shape** (square, circle, rectangle or ellipse), and **Width** settings for the effect.  
The default shape is a circle.
3. Left-click to position the center of the highlighted area.
4. Right-click and drag to re-size and adjust the aspect of the highlighted shape.
5. Customize the magnifier effect by adjusting its parameters, which vary depending on the selected effect style.

## To track in 2D:

1. After the initial selection of the area to be highlighted, move the video to a new position.
2. Left-click on the center of the area to be highlighted.
3. Repeat several times.

PIERO will interpolate between the positions automatically.

## Magnifier Effect for Piero Touch

This section outlines how to use the effect in Piero Touch.

### To configure the Magnifier effect for Piero Touch:

1. In PIERO, select the **Touch** button to enable Touch mode.
2. Add a Magnifier effect to the project.
3. In the property sheet, in the **Properties** tab, adjust the following properties:
  - **Magnification**: Use the slider to adjust the magnification level.
  - **Shape**: Select the shape of the effect from the **Shape** drop-down.
  - **Shape Width**: Use the slider to adjust the width.
  - **Fixed Position Mode**: Use the check box to enable/disable the fixed position mode.
  - **Transition**: From the **Transition** drop-down menu, select the desired transition style for the effect.
4. In the **Border** tab, customize the border settings (style, sequence, color, etc.).
5. In the **Background** tab, from the **Video Filter** drop-down, select a video filter.  
When a filter is selected, its properties will be displayed.

### To use the Magnifier in Piero Touch:

1. Add a Magnifier effect to the project.
2. Tap on the video window where you want the effect to appear
3. Drag the effect to reposition it to a different location.  
This moves the effect; it does not add another magnifier.

## Tracked Magnifier



The Tracked Magnifier effect is used to highlight or magnify and track an area of the screen. It is available in **Live** and **Touch** modes only. The small **T** in the bottom-right corner of the icon indicates that this is the Tracked version.

This effect requires [Calibration](#)<sup>[34]</sup> and a [Keyer](#)<sup>[32]</sup>.

This effect functions similarly to the standard Magnifier effect, with the distinction that tracking is automated when the **AutoAnimateOff** checkbox in the property sheet is unchecked.

# Markers



The Markers effect marks player positions in the real world and in the virtual stadium.

This effect requires [Keying](#)<sup>[32]</sup> and [Calibration](#)<sup>[34]</sup>.

★ The requirements for Calibration and Keying do not apply when the **2D** property is enabled, as the effect is then rendered in two-dimensional format without depth cues.

You can use one of the markers available in PIERO or create your own marker to use with this effect.



*Markers Effect*

## To use the Markers effect:

1. Add a **Markers** effect to the project.
2. Left-click on the pitch where you want the marker to appear (typically under the feet of the player).  
If two players are standing close to each other, try adding a new marker nearby and then dragging it to the player.
3. From the property sheet, adjust the opacity using the **Opacity** slider to set the desired transparency.
4. Use the **Keyed** checkbox to toggle the use of the Key for the effect, applying it with or without the key as needed.
5. Select the **2D** checkbox to render the effect in two-dimensional format as needed.
6. Adjust the style of the maker as desired using the options in the **Marker Style** section.
7. Use the **In Delay/Out Delay** property to define the way markers are animated, one after the other.
8. Left-click and drag to move the marker to a new position.
9. If using a double-layered marker, apply the desired style, opacity, size and color configurations in the **Layer 2** tab.
10. Use the **Text** tab to add text and configure the text style settings.

### To use a custom marker:

1. Save your custom marker graphic to the **Home/Graphics/Markers/images** folder on your PIERO system.

The graphic must be either a **.png** image (single, flat image with transparency) or an animated **.tga** sequence.

2. Add a **Markers** effect to your project.
3. From the **Marker Style** drop-down, select **Image Marker**.
4. From the **Marker Graphics** drop-down, from the images folder, select your custom marker graphic.

## Marker Effect for Piero Touch

This section outlines how to use the effect in Piero Touch.

### To configure the Marker effect for Piero Touch:

1. In PIERO, select the **Touch** button to enable Touch mode.
2. Add a Marker effect to the project.
3. Left-click on the pitch where you want the marker to appear (typically under the feet of the player).
4. Click and drag the effect to reposition as needed.
5. In the property sheet, adjust the **Marker**, **Layer 2**, and **Text** properties as needed.

### To use the Area effect in Piero Touch:

1. Add a Marker effect to the project.
2. Tap on the video window where you want the Marker to appear.
3. If you need to reposition the 2D Marker, drag the effect to a new position.

## 2D Marker



The 2D Marker effect marks a player position in the real world. It is available in **Touch** mode only.

The procedure for using and configuring the 2D Marker effect in Touch follows the same steps as the standard Marker effect in Touch mode. The primary difference lies in the default settings: for the 2D Area effect, the **2D** checkbox is selected by default to maintain a flat, two-dimensional appearance, while the **Keyed** checkbox is not selected. This distinction is important for users to note when setting up the 2D effect to ensure it functions as intended without depth effects.

## Tracked Marker



The Tracked Marker effect marks and tracks a player position in the real world and in the virtual stadium. It is available in **Live** and **Touch** modes only. The small **T** in the bottom-right corner of the icon indicates that this is the Tracked version.

This effect requires [Calibration](#)<sup>34</sup> and a [Keyer](#)<sup>32</sup>.

### To use the Tracked Marker effect:

1. Add a **Tracked Marker** effect to the project.
2. In the property sheet, adjust the parameters as desired.
3. Left-click on the player you want to mark and track.
4. To track more than one player, add another **Tracked Marker** effect to the project.
5. Then press **Play**.

The marker will automatically follow the selected player.

# Measurement Table



The Measurement Table effect displays measurements, such as ball speed or kick distance, that are generated by other PIERO effects.

This effect requires [Calibration](#) and a [Keyer](#) for the Billboard, unless you are in 2D mode, which does not require calibration or keying.

To make the best use of the Measurement Table effect, use other PIERO effects to generate measurements. Any effect that tracks a player or ball will produce speed and distance measurements.



Measurement Table Effect

## To use the Measurement Table effect:

1. Add a **Measurement Table** effect to the project and in the property sheet, select **Add New Measurement**.
2. In the **Selection** tab, choose your desired effect from the **Select an Effect** drop-down, then configure its display options as follows:

★ **Note:** You don't have to select an effect. If preferred, you can simply create a label and assign a fixed value to it.

**Measurement:** Defines the measurements based on the selected effect.

**Units:** Specify the unit of measurement.

**Show Measurement Unit:** Toggle to show or hide the unit of measurement.

**Label Text:** Enter the label text you want displayed.

**Value Text:** Use this to set a fixed value, independent of the selected effect.

The table is created and ready for further customization in the **Properties** tab.

3. In the **Properties** tab, select your customization options, such as **2D** or **Billboard mode**, **Orientation**, **Borders**, etc.
4. In the **Text** tab, select your customization options for the text, such as color, shadow, angle, etc.
5. If you want to add additional measurements, select **Add New Measurement**, and then repeat Steps 2 to 4 for each measurement you want to include in the table.

**To delete a measurement from the table:**

- Select the **Trashcan** button for the measurement you want to delete.  
The measurement is removed from the table.

## Moveable Players



The Moveable Players effect is used to move players in the video to a new position while hiding the original player position.

This effect requires [Calibration](#)<sup>[34]</sup> and a [Keyer](#)<sup>[32]</sup>.

The moveable players effect allows you to move players to different positions on the pitch. You can move a player to several positions and use a dog-leg arrow to animate them along a path. The players can be highlighted with a glow and the change of position emphasized with an arrow.



*Moveable Players Effect*

### To use the Moveable Players effect:

1. Add a Moveable Players effect to the project.
2. In the property sheet, adjust the **Leftover Player Opacity** property to control the transparency of the original position of the player.
3. Adjust the **Touch Glow Size** property to change the size of the glowing edge on moveable players, allowing the presenter to see which players can be moved by touch.
4. Use the **Line Settings** property to control the parameters of the arrow attached to the player.
5. Press the **R** key to reset the player.
6. Press the **Backspace** key to move the selected player back to its original position.

### Setting Up Touch Mode

The **RGB Keyer**, **Region Tool** and **Pause** are used in conjunction with the Moveable Players effect. They need to be set up before using the effect in **Touch** mode. The **RGB Keyer** is required to detect the players and the **Region Tool** is used to refine the detected players. As the segmented regions are only valid on one frame, a **Pause** point (VTR Control) is required to ensure the video pauses at the correct point to use the effect. It is also recommended to set up a calibration to ensure that the players appear in the correct perspective.

## Background Manual Clone Tool

When moving a player you may find the algorithm that auto fills behind the player leaves an unrealistic background. This may happen if a player is over a pitch line and a resulting gap in the line occurs. To solve this problem use the manual clone tool.

### To use the manual clone tool:

1. Left-click and drag the mouse over the problem area.

Be sure to drag the mouse beyond the player region otherwise you'll just drag the player again.

When you let go of the drag you will find the dragged area is now attached to the mouse (albeit slightly transparent).

2. Move the mouse to an area of the video that you'd like to clone.
3. When you are satisfied with the new player background, left-click the mouse to complete the cloning.

★ You can cancel a clone at any point by pressing **ESC**.

### To clone a piece of video other than the current timecode:

1. Left-click and drag the mouse over the problem area.
2. Move the video to the desired frame.
3. Align the transparent area with the desired background and left-click the mouse.

Returning to the original timecode will show the newly aligned player background.

★ You can abort a clone at any point by pressing **ESC**.

# Movie



The Movie effect inserts a movie clip (Mpeg4 or TGA sequence) onto the pitch.

This effect requires [Calibration](#)<sup>[34]</sup> and a [Keyer](#)<sup>[32]</sup>.

★ The requirements for Calibration and Keying do not apply when the **2D** property is enabled, as the effect is then rendered in two-dimensional format without depth cues.



*Movie Effect*

## To use the Movie effect:

1. Place **.mp4**, **.mov** and **.tga** folders in the **/home/PIERO/movies/** directory.
2. Add a Movie effect to the project.
3. In the **Properties** tab, adjust the essential settings for the Movie effect as needed:
  - **Movie**: Select the movie file.
  - **Movie Opacity**: Adjust the opacity to control the transparency of the movie.
  - **Constrained**: Select this checkbox to restrict the movie's movement within predefined boundaries.
  - **Keyed**: Use the **Keyed** checkbox to toggle the use of the Key for the effect, applying it with or without the key as needed.
  - **2D**: Select the **2D** checkbox to render the effect in two-dimensional format as needed.
  - **Transition Mix**: Enable this option to apply a transition effect.
4. Use the **Looping** settings to configure the repetition aspects of the Movie effect as needed:
  - **Loop**: Activate looping to have the movie repeat.
  - **Loop Start Frame**: Set the starting frame number for looping.
  - **Loop End Frame**: Set the ending frame number for looping.
5. Use the **Position** settings to configure the movie's orientation as needed:
  - **Full Screen**: Check this box to expand the movie to fill the entire screen.
  - **Billboard**: Check this box to ensure the movie behaves like a billboard, always facing the viewer.
  - **Height** and **Tilt Angle (deg)**: Use these settings to adjust positioning of the movie.
  - **Orientation**: Select the movie's orientation relative to the screen, such as center, left, right, etc.
6. Select the **Border** tab to adjust the border style settings as desired.

# Multicam



The Multicam effect creates a seamless virtual transition from one camera shot to another.

This effect requires [Calibration](#) <sup>34</sup> and a [Keyer <sup>32</sup>.](#)



Camera 1 Shot



Virtual Transition



Camera 18 Yard Shot

## Multicam Effect

Before adding the Multicam effect, you will need to set up the clip.

### To set up a clip:

1. Locate a replay from different camera angles.
2. Identify matching frames on the 2 camera angles.
3. Calibrate and key both cameras individually, and name them.
4. Use the **Clock** button to set the **INs** and **OUTs** for the calibrations and keys.
5. Add a **Region** tool for camera 1, mark it **OUT**, and give it a name.
6. From the marker, add a **Pause** to each camera and configure as follows:
  - In the **Pause Tool's** parameter sheet, from the **Action** drop-down, select **Skip to Next**.
  - After reaching the end of the first **Pause**, skip to the next one, cutting between the two cameras.
7. Return to the Region tool and configure accordingly.

For information on how to configure a **Region**, see the [Region Tool](#) <sup>75</sup> section.
8. Ensure both calibrations have a record point on the pauses.



Multicam Camera Calibration

### To use the Multicam effect:

1. Add a **Multicam** effect to the project, making it start in the first **Pause** and extend into the second **Pause**.
2. In the **1st Stadium** tab, select the **Grab Players** button, followed by the **Blend** button, and finally the **Finish** button.
3. Repeat step 2 in the **2nd Stadium** tab.

The timeline should now look similar to the example below.

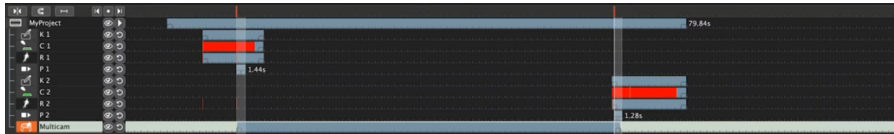

*Multicam Timeline*

4. Pair players that appear in both the 1st and 2nd views, to pair them:
  - a. Select the **Pair Players** tab.
  - b. In the video, select the players that are only visible in one view.



*Multicam - Pair Players*

5. In the **Camera** tab, make adjustments to control the movement during the transition.  
See [To adjust the advanced controls: 185](#) for instructions.

### To cut out players and goal posts:

1. In the **1st Players** and **2nd Players** tabs, separate the players so each is in their own region and none are overlapping.

It's okay if this means some are missing limbs. The animation will be better if PIERO has the right number of regions. These regions always face the camera during the transition movements.

2. Draw the base line first (on the ground) to set the orientation.
3. Then use the **Perspective Lasso** tool to cut out the goal posts.

This blue region will stay in perspective during the transition movements.

### To create a virtual stadium:

1. In the **1st Stadium** and **2nd Stadium** tabs, select the **Grab Players** button, then the **Blend** button and then the **Finish** button.

2. Play the video back and forth and select **Blend** to grab more textures from the original footage.

Calibration must track at all times during this process.

3. Left-click and drag to draw a rectangular area on the grass to capture a pattern.

This pattern will be used to fill the whole pitch where no snapshots have been taken.

4. Left-click and drag to grab a similar rectangular area in the crowd to achieve a similar fill around the stadium.

5. Once enough textures have been sampled, go back to the first **Pause** timecode and select **Finish** to grab the starting frame of animation.

6. If there are any black borders visible at the edges, adjust the **Edge Blending** to remove them from the animation.

### To adjust the advanced controls:

1. In the **Camera** tab, adjust the **Camera Zoom** duration and the **Blend** duration to control how the **Multicam** effect is rendered.

2. Select **Add Keyframe** to add extra keyframes to create custom movements.

3. Select **Add Pause** to add pause points.

4. Select **Add Blend** at points where you want to blend.

5. Select **End Camera** to stop the camera movement.

6. Select the **Play** button to show a preview of the **Multicam** effect.

## Using the Multicam Effect as a Real Stadium

The multicam effect can be used on a single camera much like the virtual stadium to visualize the scene from a different angle while retaining the real atmosphere.

### To use the Multicam effect as a real stadium:

1. Move the video to the exact frame required and add the **Pause** effect in the normal way.
2. Add a multicam effect to the project and set up the 1st view on the current calibration.
3. Set the position where the stadium mixes on and off by dragging the delay within the **Pause** effect.
4. Clean up any missing virtual players and extraneous pitch lines on the **1st Players** tab.
5. Finally, add other effects and virtual camera effects to change the stadium view to anywhere within the stadium.
6. In the property sheet, adjust the following properties to fine-tune the final result:
  - Select/deselect the checkboxes for the **Pitch, Crowd, Players** and **Camera**.
  - Artificial pitch lines can be added using the **Artificial Pitch Lines** slider bar property.
  - The higher the slider, the more opaque and wider the artificial lines.
  - The skydome around the stadium can be changed to a non-video source (such as a sunset) if required using the **Skydome Type** property.

# Offside Marking



The Offside Marking effect displays an offside line on the pitch. There are various styles of line available, such as strips or two lines. You can also have an image or movie on a wall along the line.

This effect requires [Calibration](#) <sup>34</sup> and a [Keyer](#) <sup>32</sup>.



One Line Offside Line



Two Line Offside Line

*Offside Marking Effect*

## To use the Offside Marking effect:

1. Add an Offside Marking effect to the project.

An offside line appears in the video window. The effect defaults to shade the area from the line to the nearest goal.

2. Left-click or drag the defender line to reposition it.

The length of the offside line is determined by the pitch width and cannot be changed.

3. Press **Shift** and left-click or drag the attacker line to reposition it.

4. In the property sheet, located under the **Offside** tab, the **Type** property can be changed to **Line** to create a single line, **Strip** to create 2 lines, or **Area (10m)** to create a 10m area.

The default **Type** is **Area**, which creates an area that covers the whole offside area.

5. Edit the settings as required.

6. Amend the text as desired.

If the distance between the defender and the attacker is positive, then the text will display "**Offside**". Otherwise the text will display "**Legal**".

7. Right-click to position the text.

8. Press the left arrow on the keyboard to position the shade towards the left goal.

9. Press the right arrow on the keyboard to position the shade towards the right goal.

**To add an image or movie to the Offside Marking effect:**

- In the property sheet, do one of the following:
  - a) Select the **Line** type and from the **Style** drop-down, select a style that can display an image or movie, e. g., **Image Wall** or **Movie Wall**.

If you selected the **Image Wall**, from the **Image File** drop-down, select the image you want to display.

If you selected the **Movie Wall**, from the **Loop Movie** drop-down, select the movie you want to play.

**OR**

- b) Select the **Area** or **Area (10m)** option and from the **Area Style** drop-down, select **Image** or **Movie**.

If you selected **Image**, from the **Image File** drop-down, select the image you want to display.

If you selected **Movie**, from the **Animation** drop-down, select the movie you want to play.

## Pitch Zone



The Pitch Zone effect divides the pitch into different zones for analysis purposes. The zone options vary with the sport selected when PIERO is launched.

This effect requires [Calibration](#) and a [Keyer](#).

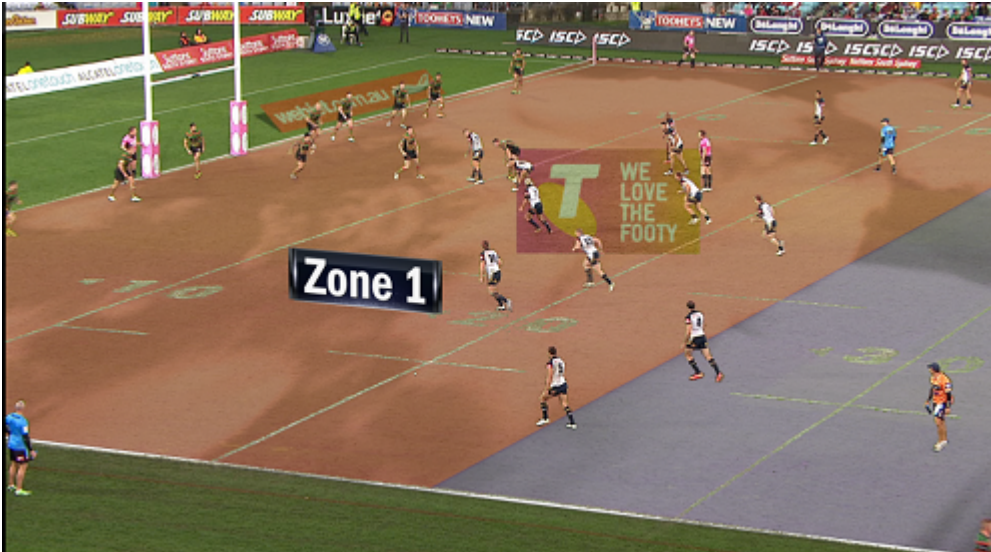

*Pitch Zone Effect*

### To use the Pitch Zone effect:

1. Add a **Pitch Zone** effect to the project.
2. In the **Properties** tab, use the **Zone Type** drop-down to adjust how the pitch is divided. The available options vary based on the selected sport.

Additional customization options may also appear depending on the **Zone Type** selected.

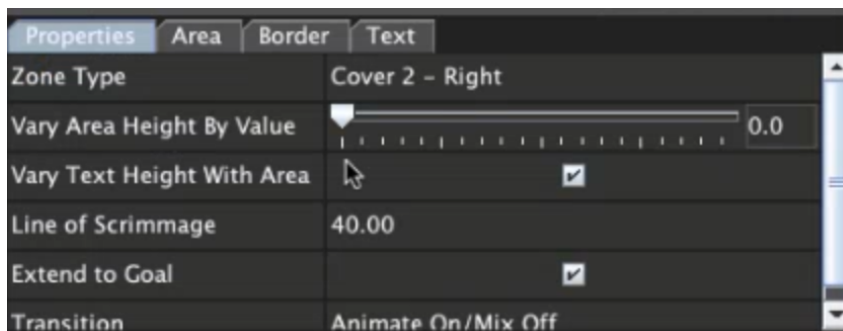

*Pitch Zone - Properties Tab*

- On the **Zone** model, select a zone to make it active and then use the properties at the bottom of the **Property** tab to change the color of the zone and edit the text that is displayed within it.

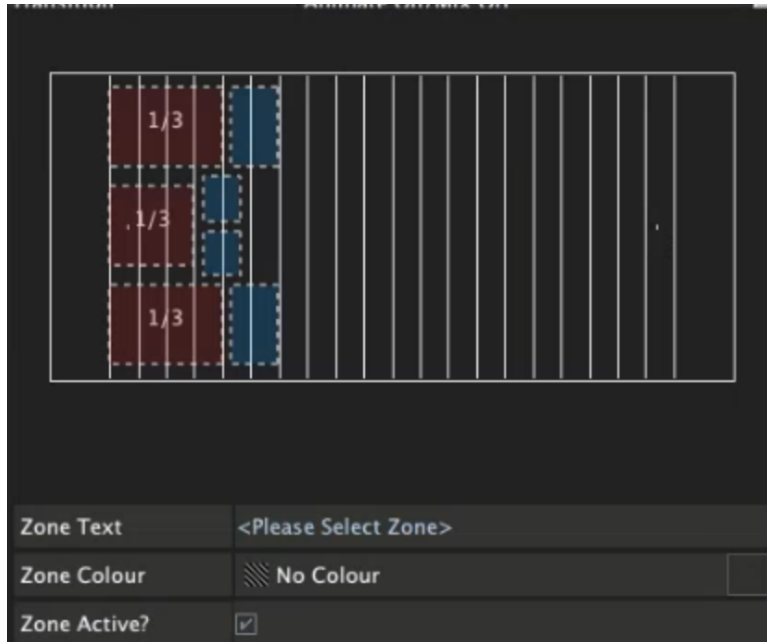

*Pitch Zone - Zone Properties*

- In the **Area** tab, adjust the area style to your preference.
- In the **Border** tab, adjust the border style to your preference.
- In the **Text** tab, adjust the text style to your preference.
- In the video window or in the **Zone Properties** model, left-click on a zone to select it and then right-click on the text to reposition it.

### To create a graph:

- Add a **Pitch Zone** effect to the project.
- In the **Area** tab, use the **Area Style** drop-down to select a 3D area style for your graph. Then, adjust the graph using the available customization options, which will vary based on the 3D area style you choose.

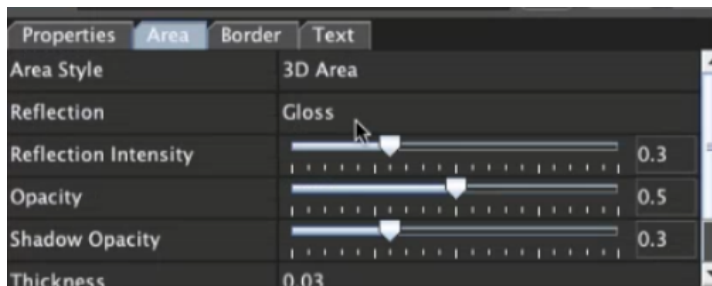

*Pitch Zone - Area Properties*

3. In the **Properties** tab, select a zone.

The selected zone is highlighted in green.

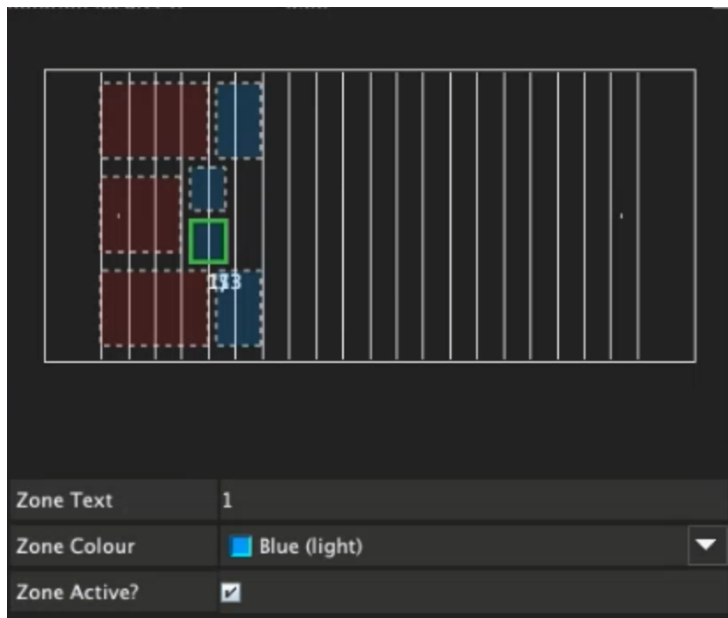

*Zone Model - Zone Highlighted in Green*

4. In the **Zone Text** field, enter the text for the selected zone.

Additionally, you can access further customization options for the text in the **Text** tab.

5. From the **Zone Colour** drop-down, select the color you want.
6. Return to the **Properties** tab, and use the **Vary Area Height By Value** slider to adjust the height of the graphical element as needed.

## Player Data Track



The Player Data Track effect creates tracks from positional player data. This effect requires TRACAB or STATS positional player data.

This effect requires [Calibration](#) <sup>34</sup> and a [Keyer](#) <sup>32</sup>.

You will need the full match video from a wide angle camera and the matching data for the whole match.

### To set up the Player Data Track effect:

1. Create the teams with names and numbers in the [Asset Manager](#) <sup>257</sup>.

The teams you create will appear in the **Teams** tab of the **Settings** panel in the PIERO UI.

2. In the **Settings** panel of PIERO, select the **Home** and **Away** teams.

### To use the Player Data Track effect:

1. Add a Player Data Track effect to the project.
2. In the property sheet, use the **Data** file browser to navigate to an **.xml** file containing TRACAB or STATS data.

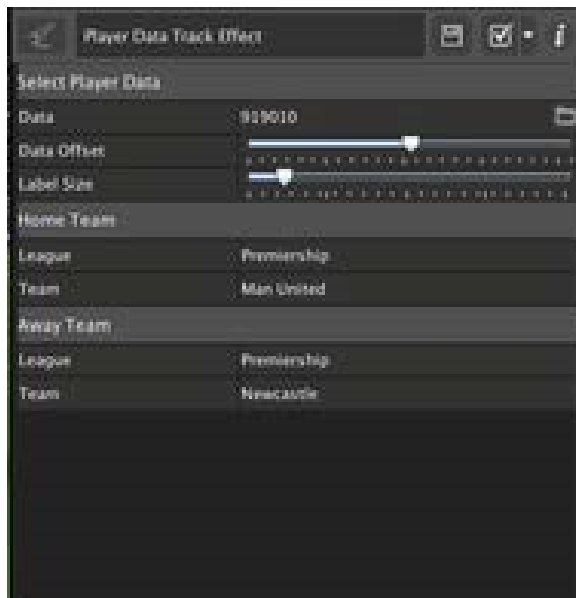

*Player Data Track Property Sheet*

3. Click on the feet of four players who are spaced around the pitch. The names of the players should appear above the players heads.

4. If not, select some more players.



*Player Data Track Effect*

5. Use any track effect to link to one of the tracks created by the Player Data Track effect.

## Player Glow/Grow



The Player Glow/Grow effect highlights a player by adding a glow around them.

This effect can be utilized with the region tool in challenging situations or when additional precision is required.

This effect requires [Calibration](#) <sup>[34]</sup> and a [Keyer](#) <sup>[32]</sup>. If the video is in a pause, calibration is not needed—only the key is required.

Once the key is done, use the **Region Tool** to refine the player regions.



*Player Glow Effect*

### To use the Player Glow/Grow effect:

1. Add a **Player Glow/Grow effect** to the project.
2. In the video viewer, select the player(s) to be highlighted with the glow.
3. Adjust the **Size**, **Intensity**, and **Color** of the glow as desired.

## Player to Player



This effect highlights the distance between two players and has the option to track their movement.

This effect requires [Calibration](#) <sup>34</sup> and a [Keyer](#) <sup>32</sup>.

★ The requirements for Calibration and Keying do not apply when the **2D** property is enabled, as the effect is then rendered in two-dimensional format without depth cues.



*Player to Player Effect*

### To create a Player to Player Track (Method 1 - Auto-Tracking):

1. Add a Player to Player effect to the project.  
A yellow rectangle surrounds each player when not selected, and a red rectangle appears when they are selected.
2. Click the middle mouse button in the rectangle surrounding the 2 players you want to track.  
**Auto Track** mode is applied.
3. Play the video to create a track.
4. Press the **>** key to advance the video in intervals (optional).

### To create a Player to Player Track (Method 2 - Manual Tracking with Intervals):

1. Add a Player to Player effect to the project.
2. Left-click under the feet of each of the 2 players you want to track.
3. Press the **>** key to advance the video to the next interval.  
Alternatively, you can select **Play**.
4. Left-click again under the feet of each of the 2 players you are tracking, in the same order as the first time.  
Use the numbers next to the track handles to remind you in which order you selected.

5. Press the > key to advance the video to the next interval.

Alternatively, you can select **Play**.

6. Repeat Steps 4 and 5 until the track is complete.

Other useful properties are described in the table below.

Property	Description
<b>Please Add Tracks</b>	Select an existing track from the drop-down list to add it to the project.
<b>Increment Row</b>	When checked, each track is affected by any changes. When not checked, you can work on one track at a time without continuing the other tracks. Default is checked.
<b>Interval</b>	Use the <b>Interval (secs)</b> slider to adjust the speed of the interval. Adjust the interval speed as needed: reduce it to show more detail, or increase it to go faster with less detail.
<b>Keyed</b>	Use the <b>Keyed</b> checkbox to toggle the use of the Key for the effect, applying it with or without the key as needed.
<b>2D</b>	Select the <b>2D</b> checkbox to render the effect in two-dimensional format as needed.
<b>Line Style</b>	In the <b>Borders</b> tab, from the <b>Line Style</b> drop-down, you can select from multiple line styles, <b>3D Border</b> , <b>Line</b> , <b>Chalk</b> , etc. When selected in the <b>Line</b> tab, the standard marker properties will be displayed.
<b>Marker Style</b>	Select to enable markers. When selected in the <b>Marker</b> tab, the standard marker properties will be displayed.
<b>Trail Style</b>	From the drop-down menu, select the desired style for the trail. When selected in the <b>Trail</b> tab, the standard trail properties will be displayed.
<b>Text Measure</b>	From the <b>Text</b> drop-down, select the unit of measurement for displaying the distance between two players. When selected in the <b>Text</b> tab, the standard text properties will be displayed.

### Tip 1

The **Increment** row checkbox is selected by default on the property sheet. If you un-check this, you can select one of the Player to Player tracks and keep working on it individually, going forwards.

### Tip 2

You can select a track from the list of **Player to Player** tracks to edit it. In this case you will see the whole track and handles appear.

# Point Map

	The Point Map effect marks the location from which a shot was made. It is only available in <b>Live</b> mode for rugby.
---	--

This effect requires [Calibration](#) <sup>34</sup> and a [Keyer](#) <sup>32</sup>.

Use one Point Map effect, per period, per team, to record their successful and unsuccessful shots.



*Point Map Effect*

### To use the Point Map effect:

1. Select **Live** in the main PIERO user interface.
2. Add 2 groups, 1 per team.
3. Name the first group after the **Home** team and name the second group after the **Away** team.

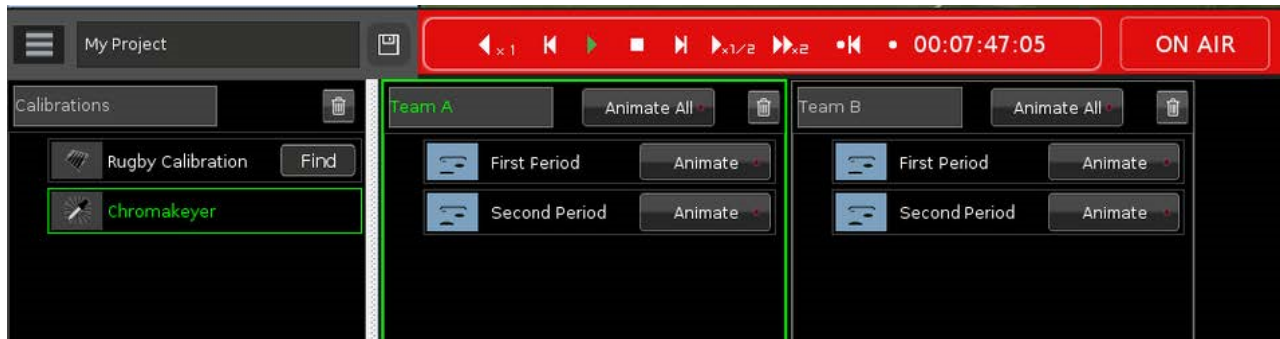

*Point Map Setup*

4. Add 2 Point Map effects per group to the project.
5. Name 1 effect in each group **"First Period"** and name the other effect in each group **"Second Period"**.

**To configure the teams' effects:**

1. Select the **First Period** effect for Team A and right-click in the video window where shots are taken from.
2. In the property sheet, select whether or not the shot scored.

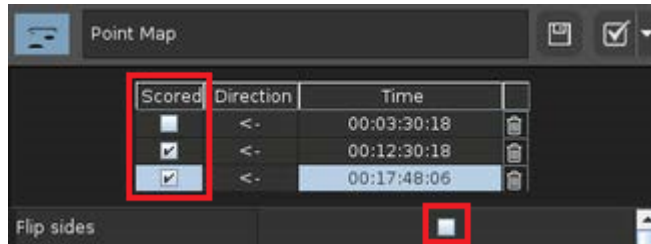

*Point Map Property Sheet*

3. Select the **Flip** sides checkbox and repeat Steps 1 and 2 for the second period.
4. Perform Steps 1 to 3 for Team B.
5. Click the **Animate** button beside each period to view the effects.

# Point to Point



The Point to Point effect marks the location from which a shot was made. It is available in **Touch** mode and in the iPad remote application for rugby.

This effect requires [Calibration](#)  and a [Keyer](#) .

★ The requirements for Calibration and Keying do not apply when the **2D** property is enabled, as the effect is then rendered in two-dimensional format without depth cues.

## To use the Point to Point effect:

1. Add a Point to Point effect to the project.
2. Left-click at the feet of the first player (where the ball pass you want to illustrate originates).
3. Then left-click at the feet of the player receiving the pass.
4. Continue left-clicking until the play is captured.
5. Click again on the point.

Other useful Point to Point properties are described in the table below.

Property	Description
<b>Area Type</b>	Defines the shape of the area.
<b>Keyed</b>	Use the <b>Keyed</b> checkbox to toggle the use of the Key for the effect, applying it with or without the key as needed.
<b>2D</b>	Select the <b>2D</b> checkbox to render the effect in two-dimensional format as needed.
<b>Transition</b>	From the <b>Transition</b> drop-down menu, select the desired transition style for the effect. <ul style="list-style-type: none"><li>• <b>Animate</b> - draws the arrow from zero to the given height</li><li>• <b>Mix</b> - fades in the arrow with no change in height.</li></ul>
<b>Marker Style</b>	Select to enable markers. When selected in the <b>Marker</b> tab, the standard marker properties will be displayed.
<b>Border Style</b>	From the <b>Border Style</b> drop-down menu, select the desired style for the border. When selected in the <b>Border</b> tab, the standard border properties will be displayed.
<b>Area Style</b>	From the <b>Area Style</b> drop-down menu, select the desired style for the area. When selected in the <b>Area</b> tab, the standard area properties will be displayed.
<b>Text</b>	From the <b>Text</b> drop-down, select the unit of measurement for displaying the distance of a shot in the Point to Point effect.

Property	Description
	When selected in the <b>Text</b> tab, the standard text properties will be displayed.



The 2D Point to Point effect, appearing in two-dimensional form, marks the location from which a shot was made in Touch mode.

The procedure for using and configuring the 2D Point to Point effect in Touch follows the same steps as the standard Point to Point effect in Touch mode. The primary difference lies in the default settings: for the 2D Point to Point effect, the **2D** checkbox is selected by default to maintain a flat, two-dimensional appearance, while the **Keyed** checkbox is not selected. This distinction is important for users to note when setting up the 2D effect to ensure it functions as intended without depth effects.

## Range



The Range effect counts from a start value to a stop value over a specified amount of time.

### To use the Range effect:

1. Add a Range effect to the project.
2. In the property sheet, set the **Start** and **Stop** values and **Accuracy**.  
You can have more than one **Start/Stop** time range in the same effect.
3. In the **Text** tab, configure the **Text** and **Background** style.
4. In the **Effect** Link tab, you can link the **End** value to another measurable effect (i. e., **Distance**, **Counter**, **Timer Text**) or to a DataLinq source.
5. In the **Sound** tab, add the sound effect to be played at the end of the effect.

## Effect Control Buttons

The Range effect control buttons are described below:

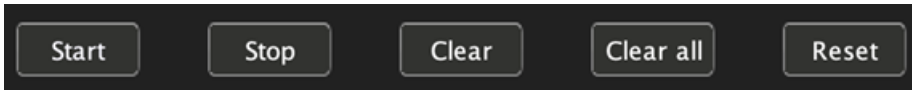

*Range Effect Control Buttons*

- **Start/Stop** - Adds one or more **Start/Stop** time ranges in the same effect.
- **Clear** - Removes the **Start/Stop** point added at that point in the timeline. It activates when the timeline is on a **Start/Stop** point.
- **Clear all** - Removes all the **Start/Stop** points, ignoring the **Start/Stop** value and leaving the effect at **0**.
- **Reset** - Removes all **Start/Stop** points added and resets the original time range.

If you accidentally add an extra **Start** point, it will be ignored in the time calculation e. g., START - START - START - STOP will be processed as START - STOP.

Similarly, if you accidentally add an extra **Stop** point, it will be ignored in the time calculation e. g., START - STOP - STOP - STOP will be processed as START - STOP.

## Red Zone



The Red Zone effect draws a 20 yard area at the selected end of the pitch.

This effect requires [Calibration](#)<sup>[34]</sup> and a [Keyer](#)<sup>[32]</sup>.

### To use the Red Zone effect:

1. Add a Red Zone effect to the project.  
A 20 yard area is automatically drawn at the right (default) end of the pitch.
2. In the effect's property sheet, use the **Pitch End** drop-down to switch the **Red Zone** to the left end of the pitch.
3. In the **Area Style** section of the property sheet, adjust the parameters to change the look of the area, including adding an image (such as a logo) to the area.
4. In the **Line Style** section, add and edit a line to mark the edge of the Red Zone area.

## Removable Players



The Removable Players effect allows you to focus on one or more players by making the rest of the players in the scene transparent or invisible.

This effect requires [Calibration](#) <sup>[34]</sup> and a [Keyer](#) <sup>[32]</sup>. Additionally, you may also need to use the [Region Tool](#) <sup>[75]</sup> to define the players.

In some sports, like basketball, the **RGB Keyer** alone might not work well enough, due to the similarities in color between the players' clothes and the pitch. In such cases the **Region Tool** is required.



*Removable Players Effect*

### To use the Removable Players effect:

1. Add a Removable Players effect to the project.
2. Click on the player(s) you want to focus on to highlight them.
3. In the property sheet, adjust the **Leftover Player Opacity** property to change the transparency of the non-highlighted players.
  - A value of **0** makes the non-highlighted players invisible.
  - A value of **100** makes the non-highlighted players fully visible.
4. If it's necessary to use the **Region Tool**, add the tool and create regions around the players.
5. Select the **Key Players** property in both the **Region** tool and the **Removable Players** effect.
6. If the players' uniforms are similar in color to the pitch and the key causes parts of the players to be missing, deselect **Key Regions** in both the **Removable Players** effect and in the **Region Tool** to disregard the key and only use the regions that have been created.

You must have cut the players out using the **Region Tool** for this to work.

## Removable Players for Touch

This effect can also be used with **Touch**. Like other effects such as [Moveable Players](#)<sup>182</sup> or [Player Glow/Grow](#)<sup>196</sup>, regions need to be defined for the timecodes that are being worked at or the effect will not work.

# Rounding Angle



The Rounding Angle effect is designed for baseball analysis, illustrating the angle a player takes while rounding a base. This effect visually highlights the runner's path by displaying an adjustable angle with a labeled line, offering insights into their trajectory.

This effect requires [Calibration](#)<sup>34</sup> and a [Keyer](#)<sup>32</sup>.

## To use the Rounding Angle effect:

1. Add the **Rounding Angle** effect to your project and adjust its length in the timeline.
2. In the property sheet, from the **Starting Base** drop-down, select the starting base (Home, First, or Second).
3. In the video, click on the base that corresponds to your selection in step 2.

Two lines will appear, pointing to the next two bases, along with a red circle around rounding base. This circle represents the threshold for tracking key frames and calculating the rounding angle.

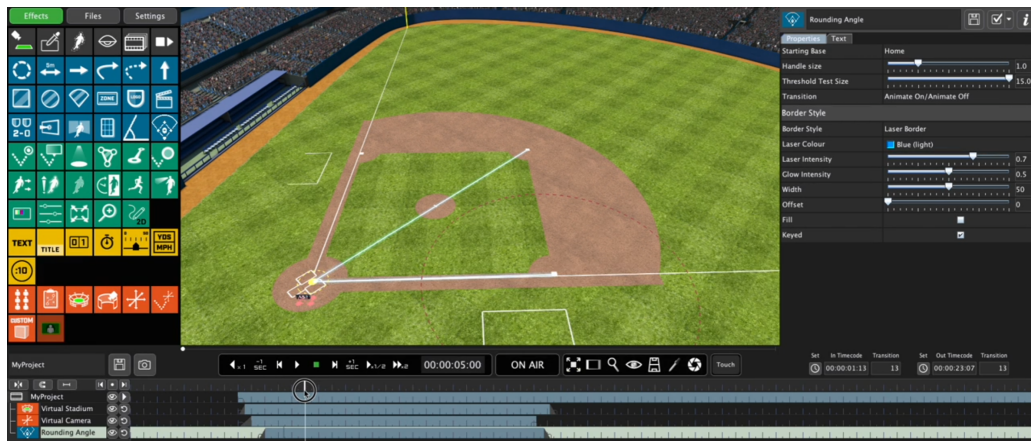

*Rounding Angle - Starting Base and Rounding Base*

4. Modify the size of the threshold circle using the **Threshold Test Size** slider in the property sheet. A smaller circle improves accuracy but requires more precise placement of track points, while a larger circle increases the risk of missing frames.
5. Track the player making the run by clicking under their feet in the video to create track points as they move, ensuring there are track points on each side of the rounding base.
6. Place additional track points inside the threshold circle to improve the effect's calculations.



*Track Points Inside the Threshold Circle*

As the player rounds the base, the lines will switch and redraw to measure the angle cut from the line connecting the rounding base to the next base. This behavior requires track points after the rounding base to trigger the transition. For smoother transitions, use more track points during this phase.

★ If the angle appears to change abruptly (e.g., from large to small), this is normal and part of the effect's calculation process.

7. Next, you can customize the track effect as follows:

- **Properties Tab** - use this tab to navigate to the **Border Style** section, where you can customize the border's style, including options for its color, width, etc.
- **Text Tab** - use this tab to customize the text (such as opacity, size, tilt, orientation, text background, etc.).

# Rugby Gain Lines



The Rugby Gain Line effect draws a gain line across the pitch and includes text and an arrow that indicates the side of the line on which the ball is dead.

This effect requires [Calibration](#) and a [Keyer](#).



*Rugby Gain Line Effect*

In rugby, the gain line is an imaginary line across the field at the point that the ball becomes dead. The center of a scrum, a line out, a maul, etc. are gain lines.

The Rugby Gain Line effect is intended for live use.

## To use the Rugby Gain Line effect:

1. Add a Rugby Gain Line effect to the project.
2. Click on the pitch at the line position.
3. Use the left and right cursor keys, or the **Left Direction** checkbox on the property sheet to change the direction of the gain line.
4. Adjust the distance of the arrows from the center line of the pitch using the **Arrow Pitch Fraction** property, with 0.5 (half the pitch) putting the arrows at opposite ends of the line.

## Scores and Badges

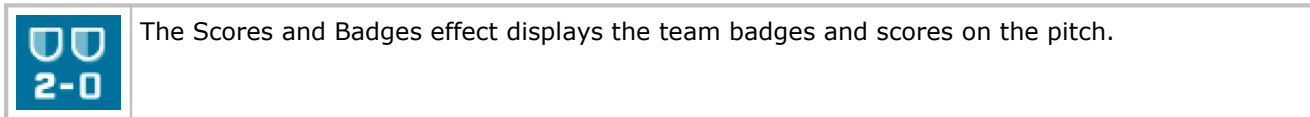

This effect requires [Calibration](#) <sup>[34]</sup> and a [Keyer](#) <sup>[32]</sup>.

★ The requirements for Calibration and Keying do not apply when the **2D** property is enabled, as the effect is then rendered in two-dimensional format without depth cues.

This effect pairs well with the Environmental Luminance Key in the Keyer, offering complementary functionality.



*Scores and Badges Effect*

### To use the Scores and Badges effect:

1. Add the **Scores and Badges** effect to the project.
2. In the **General Properties** tab, from the **Home Team** drop-down, select the home team badge.
3. From the **Away Team** drop-down, select the away team badge.
4. In the **Home Score** and **Away Score** fields, enter the home and away scores.
5. Drag the home team badge to the desired location.

Additionally, you can use the handles around the badge/score to resize the image.

★ When interacting with the home badge, the away badge will mirror the behavior of the home badge. Resizing or moving the home badge will generate a corresponding change on the away badge.

6. Use the **Logo Properties** tab to customize the appearance of the logo.
7. Use the **Score Properties** tab to customize the appearance of the score.

★ **Note:** The **Logo Properties** and **Score Properties** tabs include settings for **Keyed** and **2D** options:

- **Keyed:** Use the checkbox to toggle the use of the Key for the effect, applying it with or without the key as needed.
- **2D:** Select the checkbox to render the effect in a two-dimensional format, which is useful for handling complex or un-keyable backgrounds.

# Screen



The Screen effect adds a virtual wall to the scene to illustrate a blocking zone.

This effect requires [Calibration](#) <sup>34</sup> and a [Keyer](#) <sup>32</sup>.

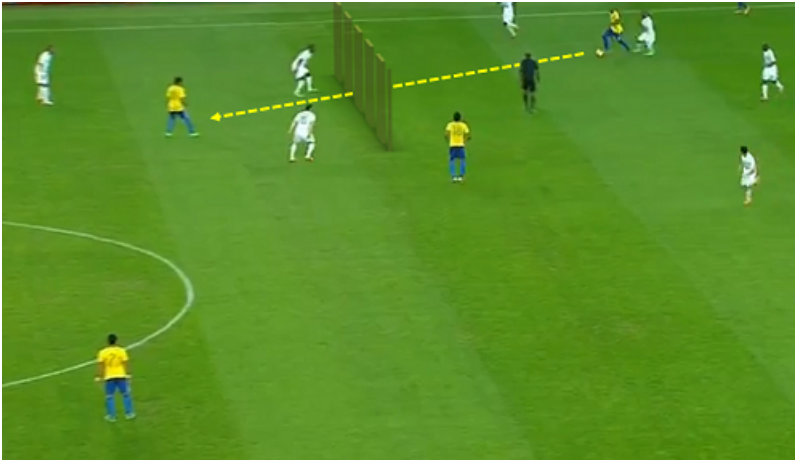

*Screen Effect*

## To use the Screen effect:

1. Add a Screen effect to the project.
2. Left-click on the pitch to position one end of the screen and then left-click again to position the other end.
3. Continue to left-click in new positions to add more panels of the screen.
4. In the property sheet, from the **Style** drop-down, select the type of screen you want to display.
5. In the **Height from Ground** property, enter a value to adjust the location of the screen relative to the ground.
6. Use the **Keyed** checkbox to toggle the use of the Key for the effect, applying it with or without the key as needed.
7. From the **Transition** drop-down, select the desired transition style for the effect.
  - **Animate** - draws the arrow from zero to the given height.
  - **Mix** - fades in the arrow with no change in height.
8. Adjust the **Wall Height** properties to get the size of screen you want.
9. Edit the other properties for appearance and animation style, if desired.

# Smash-o-Meter



The Smash-o-Meter effect displays the severity of an impact as a percentage of a known impact.

This effect requires [Calibration](#)<sup>[34]</sup> and a [Keyer](#)<sup>[32]</sup>.



*Smash-o-Meter Effect*

The Smash-o-Meter effect calculates the deceleration in G and compares it to a known impact. The G-Force calculation is based on the player weights, speeds and orientation vectors.

We suggest you measure the biggest impact ever seen or remembered for your league and use it as a reference. This will allow stories such as: "This impact equals 83% of the legendary \_\_\_\_\_ tackle."

## To use the Smash-o-Meter effect:

1. Calibrate and track 2 players.
2. Ensure the players are tracked for a few frames after the impact.  
Stopping the track on the impact can alter readings.
3. Add a Smash-o-Meter effect to the project.
4. Select **Track 1** and **Track 2**.
5. Input the weights of both players.
6. Advance the video to the frame where the impact occurs and select **Get Impact**.

The G-Force value (deceleration) will be shown in red at the top-left corner of the screen. The percentage shown is based on the **Max Impact Value** (the value of the biggest impact recorded in the league).

7. In the property sheet, adjust the **Animation Speed** property to control the speed of the animation.

## Visuals

Although it is crucial to get the impact on the right frame, it is possible to start the animation (numbers going up) at any point. Use the **Start Animation** button to define when the gauge begins animating.

The effect can be used in several ways.

- Graphic appears, players run into each other, video pauses, percentage increases.
- Graphic appears, players run into each other, percentage increases as the video plays.
- Players run into each other, video pauses, graphic appears with percentage increasing.

Graphics can be customized. They are based on **.tga** sequences. You can use a custom introductory video, so that the gauge appears with unique graphics, rather than mixing on or scaling up. Ensure the effect is long enough to allow the animation to play to the end.



*Smash-o-Meter Custom Graphics*

# Sound



The Sound effect allows you to add sound effects into your analysis.

You will need audio files in the PIERO sounds folder in order to be able to use them.

Audio is enabled via the Launcher at start-up and is configured in the project.

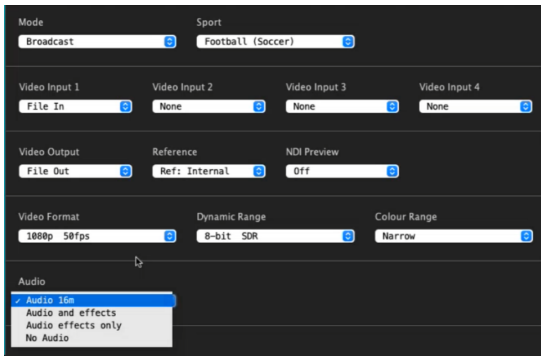

*Broadcast Launcher - Audio Section*

## To add sound to a project:

1. From the **Launcher**, from the **Audio** drop-down, select the audio option you want to use, and launch PIERO.
2. In the **Effects** panel, select the  **Sound Effect** button.  
The **Sound effect** appears in the timeline.
3. Position the **Sound effect** where you want it along the timeline and adjust its duration.
4. In the **Sound effect's** parameter sheet, select the File folder icon.  
The file explorer opens.
5. Navigate to the location of the sound file you want to use and select **Open Sound**.  
The file explorer closes and the sound is added to the **Sound effect**.

# Spotlights



The Spotlight effect highlights and tracks a player with a spotlight or uplight.

This effect requires [Calibration](#) <sup>34</sup> and a [Keyer](#) <sup>32</sup>.

★ The requirements for Calibration and Keying do not apply when the **2D** property is enabled, as the effect is then rendered in two-dimensional format without depth cues.



*Spotlight Effect*

## To create a Spotlight track (Method 1 - Auto-Tracking):

1. Add a Spotlight effect to the project.  
A blue rectangle appears around each player.
2. Click the middle mouse button in the rectangle surrounding the player you want to track.  
**Auto Track** mode is applied.
3. Play the video to create a track.
4. Press the **>** key to advance the video in intervals (optional).

## To create a Spotlight track (Method 2 - Manual Tracking with Intervals):

1. Add a Spotlight effect to the project.
2. In the property sheet, press the **Manual Interval** mode button.
3. Left-click under the feet of the player you want to spotlight.  
The video advances automatically to the next interval.
4. Left-click under the feet of the same player again.  
The video advances automatically to the next interval.

5. Continue left-clicking under the feet of the player you want to spotlight for as long as you want to track that player.

**OR**

Left-click and drag a track point to a new position.

**To modify the spotlight:**

1. In the **Spotlight** tab, configure the spotlight settings as needed:
  - **SpotLight Source:** From the drop-down, choose the direction of the spotlight.
  - **Path Type:** From the drop-down, choose the direction of the spotlight (curve or down).
  - **Handle Size:** Use the slider to adjust the size of the handle.
  - **Keyed:** Use the checkbox to toggle the use of the Key for the effect, applying it with or without the key as needed.
  - **2D:** Use the checkbox to render the effect in two-dimensional format as needed.
  - **Link to Track** : Associate the effect with a specific track.
2. In the **Style Settings** section of the **Spotlight** tab, adjust the color and intensity of the spotlight.
3. In the **Text** tab, in **Text** field, enter the information you want to display.
4. Adjust the text size, orientation, and shadow settings as needed.

## Spotlight Effect for Piero Touch

This section outlines how to use the effect in Piero Touch.

**To configure the Spotlight effect for Piero Touch:**

1. In PIERO, select the **Touch** button to enable Touch mode.
2. Add a Spotlight effect to the project.
3. Left-click on the pitch where you want the effect to appear.
4. In the **Spotlight** tab, configure the style settings as needed.
5. In the **Text** tab, in the **Text** field, enter the information you want to display.
6. Adjust the text size, orientation, and shadow settings as needed.

**To use the Spotlight effect in Piero Touch:**

1. Add a Spotlight effect to the project.
2. Click on the video window where you want the spotlight to appear.
3. Click again to move the spotlight to a different locations.

This moves the spotlight; it does not add another spotlight.

## 2D Spotlight Effect



The Spotlight 2D effect highlights a player with a two-dimensional spotlight or uplight in Touch mode.

The procedure for using and configuring the 2D Spotlight effect in Touch follows the same steps as the standard Spotlight effect in Touch mode. The primary difference lies in the default settings: for the 2D Spotlight effect, the **2D** checkbox is selected by default to maintain a flat, two-dimensional appearance, while the **Keyed** checkbox is not selected. This distinction is important for users to note when setting up the 2D effect to ensure it functions as intended without depth effects.

# Tactical Board



The Tactical Board effect displays a black board or clipboard on which you can draw lines to illustrate game analyses.

This effect requires [Calibration](#)<sup>[34]</sup> and a [Keyer](#)<sup>[32]</sup>.



*Tactical Board Effect*

## To use the Tactical Board effect:

1. Add a Tactical Board effect to the project.
2. Use the 3D option in the same way as the [Virtual Stadium](#)<sup>[253]</sup>.  
It creates a 3D clipboard or chalkboard on the floor.
3. Place it in 3D space using [Virtual Cameras](#)<sup>[243]</sup> or a [Spline Camera](#)<sup>[246]</sup>.
4. Use the **2D** option to fix the Tactical Board texture to the screen allowing the pitch lines to be placed at an angle much like a perspective drawing.
5. Add custom **.png** textures from a folder stored in **/home/PIERO/graphics/chalkboard/**.

The image below shows the standard graphic and a custom graphic for the same play.



*Tactical Board Effect - Custom*

# Team Line-up



The Team Line-up effect provides a visual representation of the team formation.

This effect requires [Calibration](#) <sup>[34]</sup> and a [Keyer](#) <sup>[32]</sup>.

The Team Line-up effect places all the players of a team onto the pitch to present the team formation.

Set up the players' pictures and movies in the [Asset Manager](#) <sup>[257]</sup> before using the Team Line-up effect. You can associate a team logo with a team in this module. Logos must be stored in a folder in the **Logos** directory.

The teams used in the Team Line-up effect are specified in the **Teams** tab of the **Settings** Panel.



*Team Line-up Effect*

## To configure a basic Team Line-up effect:

1. Add the **Team Line-up** effect to the project.
2. In the **Parameter** sheet, select the **Formation** tab, and configure the line-up formation as follows:
  - a. From the **League** drop-down, select a sport league.
  - b. From the **Team** drop-down, select a team.
  - c. From the **Strip** drop-down, select one of the available uniforms for the selected team.
  - d. From the **Formation** drop-down, select a formation (the positions of the players on the pitch). For additional information on configuring the formation, see the [To customize each players position](#) <sup>[220]</sup> procedure.
3. In the **Player** Tab, select and customize a player type.
4. In the **Substitutes** tab, select the desired number of substitutes to add to the side of the pitch and adjust their position/orientation.
5. In the **Caption** tab, adjust the caption options as desired.
6. In **Text** tab, adjust the text options as desired.

The basic **Team Line-up** has been configured.

### To add an away team:

1. Add a second **Team Line-up** effect to the project and in the **Formation** tab, select the **Away Team** checkbox.

The away team will appear on the opposite side of the pitch.

2. Follow the [To configure a basic Team Line-up effect](#) procedure to configure and customize the away team.

### To customize each players position:

1. In the Video Viewer, double-click on a player.

A new window opens. The left side of the window displays the formation selected in the **Formation** tab. The right side of the window displays the players.

Additionally, if you need to change the formation, go to the **Formation** tab and use the **Formation** drop-down to select a different formation.

2. Click and drag any player onto the position you want.



*Team Line-up - Player Position Interface*

3. When you have finished formatting each players position, select the **Done**.

★ Additionally, you can use this procedure when you want to substitute individual players on the pitch.

### To add an alternative position:

1. Select the **Touch Handle** of the player you want to move.
2. Right-click at the position on the field where you want the player to move.  
A line ending in a square will indicate the movement and the end point of the new position.
3. Left-click on the **Touch Handle** of the alternative position and drag it to adjust the position if necessary.
4. Press the **M** key to check the forward/back movement of the player.

5. Go **On Air** and play the video.



*Team Line-up - Alternative Positions*

### Notes:

- The **M** key activates the movement of all players at the same time.
- To reverse the movement, select the **M** key again.
- The **Alternative Position Touch Handles** are not visible in **On Air** mode.
- You can add an alternative position for every player.

## Team Line-up Effect in Touch

The setup has to be done in **Analysis** before the presenters can use the Team Line-up effect button in **Touch**.

Once set up, the players can be dragged into position using the Touchscreen by touching and dragging **Touch** handles.



*Touch - Team Line-up Effect*

### To configure the Team Line-up Effect for Touch:

1. Add a **Pause** effect to the project and set the **Out Action** option to **Pause** to be able to stop the video in **Touch** mode and with the **Touch** app.
2. Add a **Team Line-up** effect inside the **Pause** effect.
3. In the **Formation** tab, select whether to use the **Home** team, **Away** team or both.

In **EDIT** mode, the camera will automatically adjust to show the **Home**, **Away** or both teams regardless of the selected transitions. This is to make positioning easier before going live.

When using both teams, you need to select the video window to switch from one team to another. The camera rotation will be performed automatically.

4. In the **Formation** tab, continue to configure the line-up formation options. See the [To configure a basic Team Line-up effect](#) procedure for additional information on configuring the formation options.
5. In the **Player** tab, use the **Players/Markers/Portrait/Text Animation** properties to configure where the players animate from and the style of the animation.
6. In the **Text** tab, configure the standard text properties.

### To use the Team Lineup effect:

- Click on the square (Touch Handle) beneath any player to move them to a new position.
- Click on the square beneath any player and drag them on top of another player to swap the players.

Alternatively, you can use the **Page Up/Page Down** keys to move the player up/down in the formation.



*Team Line-up - Swap Players*



### Tips

- The **Team Line-up** effect should not be locked; if it is locked, the players won't move.
- Pressing the **Trash** icon won't delete the line-up effect.
- You can turn the text on and off by pressing **T** on the keyboard while **Live**.

## Overriding Camera Transitions

In the example shown, Virtual Cameras 1 and 2 are overriding the transition-IN, thus providing a customized transition movement.

Virtual Camera 3 changes the view while the effect is on. This can be useful to highlight a specific point during pre-game analysis.

Finally Virtual Camera 4 overrides the line-up transition-OUT and lets you move to a customized viewing angle.

In this example, a [Virtual Stadium](#) <sup>253</sup> is used in the project and the **Show Stadium** option in the Team Line-up effect is not selected.

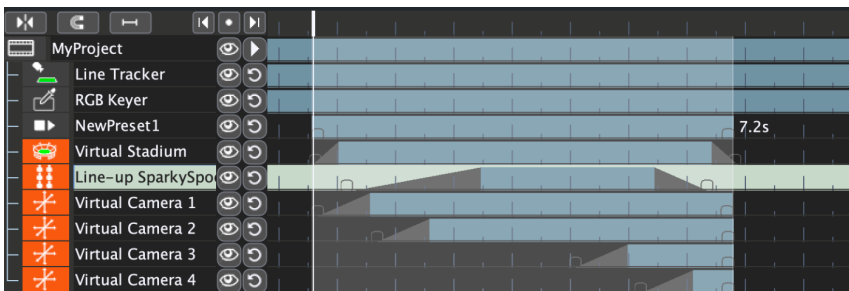

*Team Line-Up - Overriding Camera Transitions*

## Jumbotron

The incoming video feed can be put on the Jumbotron.

### To play video feed on the Jumbotron:

1. Turn on the Jumbotron in the **Virtual Stadium** tab.
2. In the **Jumbotron** Image property, select **Picture in Picture**.

This allows the presenters to remain on screen while commenting on the team formation.

# Tennis Score



The Tennis Score effect places photos, names and scores of tennis players onto the court.

This effect is only available for Tennis and requires [Calibration](#)<sup>34</sup> and a [Keyer](#)<sup>32</sup>.



*Tennis Score Effect*

## To use the Tennis Score effect:

1. Add a Tennis Score effect to the project.
2. In the property sheet, select the **Constrain Size** property checkbox so that all the text elements will re-size similarly.

Photos, names and scores will be aligned on the same row and both players' names will be centered.

3. Photos and text can be billboarded and adjusted as shown below.



*Tennis Score - Billboarding Examples*

# Text

## TEXT

The Text effect places text on the pitch or in 2D.

This effect requires [Calibration](#)<sup>[34]</sup> and a [Keyer](#)<sup>[32]</sup>.

★ The requirements for Calibration and Keying do not apply when the **2D** property is enabled, as the effect is then rendered in two-dimensional format without depth cues.



*Text Effect*

### To use the Text effect:

1. Add a Text effect to the project.
2. In the property sheet, in the **Text** property, enter the information you want to display.  
Players' names for the selected team are available for fast access. Use the [Asset Manager](#)<sup>[257]</sup> in the PIERO launcher to add players to the teams.
3. Left-click and drag the corners or press **Ctrl (cmd)** on macOS) and scroll to re-size the text.
4. Left-click in the middle of the text and drag to reposition it.
5. Use the keyboard arrows to nudge text in small increments.
6. Press **Ctrl + Arrows (cmd + Arrows)** on macOS) for a smooth nudge.  
For brands using textured text, you can change the texture in the [Asset Manager](#)<sup>[257]</sup>.  
Alternatively, it is possible to change the texture on the fly and add more custom textures from **/home/PIERO/graphics/textures/text\_background** and **text\_background\_wings**.
7. Select the **Background** tab to adjust the background style settings.
8. Select the **Position** tab to configure the text's placement across/along the pitch and its height.

Other useful effect properties are described in the table below.

<b>Property</b>	<b>Description</b>
<b>Text Line 1</b>	Allows entry of the primary text line.
<b>Text Line 2</b>	Allows entry of a secondary text line that appears below the primary text line.
<b>Player Name</b>	From the Player Name drop-down, select a players name.
<b>Player Name Layout</b>	Defines the format in which player names are displayed. Example format: "Number SURNAME," helping standardize player identification across displays.
<b>Keyed</b>	Checkbox to toggle the use of the key.
<b>2D</b>	Checkbox to render the text in a two-dimensional format as needed.
<b>Billboard</b>	Checkbox to set the text effect to behave like a billboard, making it face the camera, thereby ensuring readability regardless of camera angle.
<b>Auto Size</b>	Automatically adjusts the text size based on the space available.
<b>Text Alignment</b>	Sets the alignment of the text within the graphic (e.g., Left, Center, Right).
<b>Line Separation</b>	Adjusts the spacing between Text Line 1 and Text Line 2.
<b>Size</b>	Slider to manually adjust the text size.
<b>Text Opacity</b>	Slider to adjust the opacity of the text.
<b>Tilt</b>	Adjusts the tilt angle of the text.
<b>X Scaling</b>	Scales the text width.
<b>Orientation</b>	Provides options like Free Rotation, which offers flexibility in rotating the text to any angle, accommodating various layout needs.
<b>Link To Track</b>	Associates the text with a specific track.
<b>Transition</b>	Determines how the text appears and disappears (e.g., Animate On, Mix Off).

# Time Lapse



The Time Lapse effect highlights movements, speeds, and player skills and brings a new dimension to tracking players. It is available for American and Gaelic Football, Rugby and Tennis only.

This effect requires [Calibration](#)<sup>34</sup> and a [Keyer](#)<sup>32</sup>.

The Time Lapse effect allows the players and various other objects in the game to be followed by their snap shots. This can enrich the analysis revealing new aspects of the game. These aspects are dependent on the particular sport. In tennis, it helps evaluate and, mostly, compare the technique of the two players. Regarding football and rugby, looking at the players' grabs illustrates their skill set rather well.



*Time Lapse Effect*

## To use the Time Lapse effect:

1. Add a Time Lapse effect to the project.

White rectangles appear around each player. If the white rectangles don't appear, select your **Calibration** line and select the **Find** button.

2. If the player you're interested in doesn't have a white rectangle around them, add the [Region Tool](#)<sup>75</sup> to your project and use the **Polygon Selection** or **Lasso Selection** method to define a region around that player.

3. Use one of the following methods to capture a player's movement.

### **Grab on click:**

- a. Play the video and pause at the point where you want to take a snapshot of a player's movement.
- b. In the property sheet, select **Grab on click** and then left-click on the player whose movements are to be captured.
- c. Repeat the above steps for each snapshot.

**Auto Grab:**

- a. Left-click on the feet of the player you are interested in.
- b. In the property sheet, set the Auto Grab Sampling Rate to the number of snapshots to be taken of the player per second.
- c. Click the Auto Grab button.
- d. Play the video at normal speed.

Auto grab will take as many snapshots per second as defined in the Auto Grab Sampling Rate.

The process can be stopped at any time.

**Grab an area:**

Use when the target to be captured is not a player, but for example, the ball.

4. In the property sheet, you can adjust the following properties:

Property	Description
<b>Auto Grab Sampling Rate</b>	Defines the number of snapshots to be taken per second.
<b>Opacity</b>	The transparency of the grabs.
<b>Trail Length</b>	The number of snapshots left visible behind the current one.
<b>Trail Fading</b>	When activated, the trail's opacity will fade off to become transparent.
<b>Show Only Current Player</b>	When checked, only the selected player will be sampled.
<b>Transition</b>	Defines the manner in which the effect will appear and disappear.

## Time Lapse Run



The Time Lapse Run effect can be used to show where a player will run. It is available for Football, Rugby and Tennis only.

This effect requires [Calibration](#)<sup>[34]</sup> and the [RGB Keyer](#)<sup>[32]</sup>.

It is usually played with a VTR Pause.

The run must be acquired frame by frame over a few seconds. The difficulty in achieving this effect varies greatly with the number of players that intersect with the tracked player.



*Time Lapse Run Effect*

### To use the Time Lapse Run feature:

1. Add a **VTR Pause** to the project.
2. Then add a Time Lapse effect.
3. In the property sheet, set the **Auto Grab Sampling Rate** property to **1**.
4. Select the **Show Only Current Player** checkbox.
5. Select one of the following options:
  - If the tracked player never intersects with another player:
    - a. Click **AutoGrab**.
    - b. Select the player you want to track.
    - c. Advance the video and select **AutoGrab** again.
    - d. Select the **Animate All Tracks** transition.
  - If the tracked player intersects with other players:
    - a. In the **Edit** section of the property sheet, use the **Grab Region** or **Lasso** tool to isolate the tracked player, making sure to lasso very close to the player's feet, as it defines the player's position on the pitch.
    - b. Select the **Animate All Tracks/Mix Off** transition.
    - c. Do not change the **Transition IN** property. The run has to be played entirely at frame rate.
6. Press **Play**.

## Timer Text



The Timer Text effect places a timer on the pitch.

This effect requires [Calibration](#) <sup>[34]</sup> and a [Keyer](#) <sup>[32]</sup>.

With the Timer Text effect, you can display time in 4 ways, using combinations of the Count Down and Accumulate times properties.

This effect can be linked to a track or displayed in 2D.



*Timer Effect*

### To use the Timer Text effect:

1. Add a Timer Text effect to the project.
2. In the property sheet, use the **Start** and **Stop** buttons to set the effect's **IN** and **OUT** points.

You can have more than one **Start/Stop** time range in the same effect.



*Timer Count Settings*

3. Set the timer to count up from 0 seconds or down from the duration of the defined timeframe.
4. Use the **Text** property to add custom text.
5. Add more **Start/Stop** time ranges if required.
6. Click **Reset** to remove all **Starts/Stops** that you may have added and leave just the original ones.
7. If you want the time of each **Start/Stop** time range to be added to the starting time, select the **Accumulate times** checkbox.

If you accidentally add any extra trailing starts they will be ignored in the calculation of times e.g., START – START – START – END will be processed as START – END.

Similarly if you accidentally add any extra ends they will be ignored in the time calculations e.g., START – END – END – END will be processed as START – END.

# Title Text

	The Title effect adds a banner-style title to the video.
---	--

This effect requires [Calibration](#) <sup>34</sup> and a [Keyer](#) <sup>32</sup>.



*Title Effect*

## To use the Title Text effect:

1. Add a Title Text effect to the project.
2. Select your background from the property sheet.  
To make the best use of this effect, create your own background as a **.png** file and save it under **graphics/lowerthirds**.
3. Enter your text in the boxes on the property sheet
4. Position the text boxes in the image, relative to the effect's background
5. Drag the background to position the whole effect vertically in the image
6. Use the timeline to control how long it is visible

# Track



The Track effect tracks players by setting key frames.

This effect requires [Calibration](#) <sup>[34]</sup> and a [Keyer](#) <sup>[32]</sup> (keying is recommended).

★ The requirements for Calibration and Keying do not apply when the **2D** property is enabled, as the effect is then rendered in two-dimensional format without depth cues.

The following effects will follow a track created with the Track effect, when the Link to existing Track property is selected in their property sheet.

[Area](#) <sup>[140]</sup>

[Caption Track](#) <sup>[149]</sup>

[Dynamic Formation](#) <sup>[166]</sup>

[Markers](#) <sup>[177]</sup>

[Spotlight](#) <sup>[215]</sup>

[Virtual Camera](#) <sup>[246]</sup>

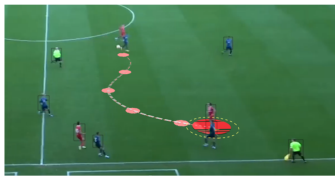

Track Effect - Handles



Track Effect - Laser Trail

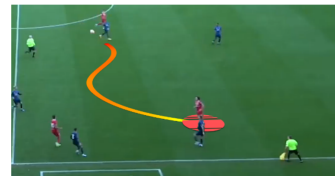

Track Effect - Speed Trail

## To create a Track (Method 1 - Auto-Tracking):

1. Add a **Track** effect to the project.  
A rectangle appears around each player.
2. Click the middle mouse button in the rectangle surrounding the player you want to track.  
 **Auto Track** mode is applied.
3. Play the video to the desired frame for the next track point, then stop the video and add another track.  
Additionally, you can press the > key to advance the video in intervals (optional).
4. Repeat Step 3 until the entire tracking sequence is complete.

## To create a Track (Method 2 - Manual Tracking with Intervals):

1. Add a **Track** effect to the project.
2. Select the  **Manual Interval** mode button on the property sheet.
3. Use the **Interval (secs)** slider to adjust the speed of the interval.

Adjust the interval speed as needed: reduce it to show more detail, or increase it to go faster with less detail.

4. Left-click under the feet of the player you want to track.

The video will play to the next interval automatically.

5. Press the > key to advance the video to the next interval and add another track.

6. Repeat Steps 4 and 5 until the track is complete.

7. Next, customize the track effect as follows:

- **Track Tab** - use this tab to customize the track path (such as path type, opacity, handle size, etc.).
- **Marker Tab** - use this tab to customize the marker effect (such as the marker style, color, size, etc.).
- **Trail Tab** - use this tab to customize the trail (such as trail style, size, color, height, etc.).
- **Measurement Tab** - use this tab to add text measurement options (such as the position, unit of measure, etc.)
- **Text Tab** - use this tab to customize the text (such as opacity, size, tilt, orientation, text background, etc.).

★ **Note:** The **Track** and **Text** tabs include settings for **Keyed** and **2D** options:

- **Keyed:** Use the checkbox to toggle the use of the Key for the effect, applying it with or without the key as needed.
- **2D:** Select the checkbox to render the effect in a two-dimensional format, which is useful for handling complex or un-keyable backgrounds.

#### To link an effect to an existing Track:

1. Add a **Track** effect to the project.

2. Select the  **Link to existing track** mode button on the property sheet.

3. From the **Link To Track** drop-down, select the **Track** effect you want to link to.

Additionally, you can link multiple effects to a single track.

### Optional Moves

- Left-click a track point position to highlight it and drag it to a new position.
- Left-click a track point and press **Backspace** to remove it.
- Press **Ctrl** and left-click to insert a break in the Bezier interpolation mechanism.

# User Model

	Use the User Model effect to draw an imported 3D model.
---	---

This effect requires [Calibration](#)  and a [Keyer](#) .

★ The requirements for Calibration and Keying do not apply when the **2D** property is enabled, as the effect is then rendered in two-dimensional format without depth cues.



*User Model Effect*

A generic 3D Model can be imported into PIERO and drawn in the correct perspective using the User Model effect. The models available to this effect are stored in the **Models/User** folder on the PIERO desktop.

## To use the User Model effect:

1. Add the User Model effect to the project:
2. In the property sheet, from the **3D Model** property drop-down, select the model to use.
3. Left-click in the middle of the square beneath the model and drag to reposition it.
4. Left-click on a control handle and drag to scale the model.
5. In the property sheet, use the **Keyed** checkbox to toggle the use of the Key for the effect, applying it with or without the key as needed.
6. Select the **2D** checkbox to render the effect in two-dimensional format as needed.
7. Adjust the orientation settings as desired (spin speed, scale, rotate x, etc.).

### OR

Click on the model and scroll the mouse wheel.

## Vertical Grid Effect



The Vertical Grid effect places a grid to the pitch.  
This effect is only available in American football and football.

This effect does not require calibration but can be [keyed](#) if needed.



*Vertical Grid Effect*

### To use the Vertical Grid effect:

1. Add a **Vertical Grid** effect to your project.

This will place a grid between the edges of the pitch, parallel to the goal line.

Additionally, the grid can be moved by selecting its handle and repositioning, it will always be parallel to the goal line.

2. Select the grid's handle to reposition, if needed.

**Note:** the grid will always be parallel to the goal line.

### Additional Options for the Vertical Grid Effect:

- You can add markers and text to the grid by clicking on it.

Each marker/text combination can have its properties uniquely modified, except for the marker style and text background style.

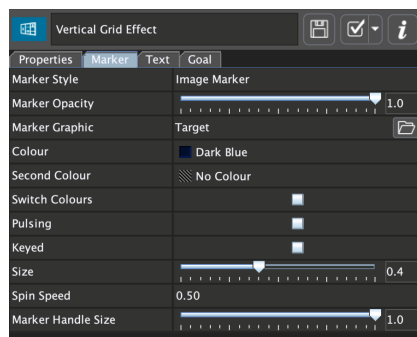

*Vertical Grid - Marker Tab*

- The grid can be put into **Update All** mode, allowing changes to all properties (except text offsets) to apply across all marker/text combinations. This can be triggered using the **A Shortcut Key**.

- The grid can snap to the goal line, and a laser grid can be applied specifically to the goal.
- The grid is supported in the OPTA data module under the **Shot Map** feature and can interact with goal markers selected in the graphics dropdown

# Video Effect

	The Video effect displays video from one of the two inputs on the PIERO system.
---	---

This effect requires [Calibration](#)<sup>[34]</sup> and a [Keyer](#)<sup>[32]</sup>.

★ The requirements for Calibration and Keying do not apply when the **2D** property is enabled, as the effect is then rendered in two-dimensional format without depth cues.

The Video effect gives you the ability to display video from either of PIERO's SDI video feeds: input 1 (SDI IN A) or input 2 (SDI IN B).

This enables you to analyse a point in the game while showing a replay or other video in the style of picture-in-picture.

## To use the Video effect:

1. Select the **Video** effect.  
The effect is automatically added to the scene.
2. In the effect's property sheet, in the **Properties** tab, from the **Video Input** drop-down, select whether to use **Video Input 1** or **2**.
3. From the **Orientation** drop-down, select the effect's orientation relative to the screen, such as center, left, right, etc.
4. Use the **Keyed** checkbox to toggle the use of the Key for the effect, applying it with or without the key as needed.
5. Select the **2D** checkbox to render the effect in two-dimensional format as needed.
6. From the Transition drop-down, select the desired transition style for the effect.
  - **Animate** - draws the arrow from zero to the given height
  - **Mix** - fades in the arrow with no change in height.
7. Configure the additional **Draw Options** settings as required (**Height**, **Scale**, **Full Screen**, **Bilboard**, etc.)
8. In the **Border** tab, edit the properties of the border of the video window as desired.

## Video Filter Effect

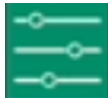

The Video Filter effect allows users to create dynamic 2D masks to highlight or obscure specific areas on-screen.

The Video Filter effect gives users the ability to apply effects such as monochrome, blur, darken, lighten, or pixelate, with options for inversion, feathering, and dynamic movement across tracks, making it a versatile tool for tailoring visual focus.



*Video Filter Effect*

### To apply a filter:

1. Add the **Video Filter** effect to your project.
2. In the parameter sheet, open the **Video Filter** tab.
3. Select a filter (**Monochrome**, **Blur**, **Pixelate**, **Darken**, or **Lighten**) from the **Video Filter** drop-down.
4. Adjust the filter's properties using the available sliders (e.g., saturation, brightness, pixel size).
  - ★ Each filter provides unique options for customization.

## Applying a Mask Area

To create a mask area (which can optionally change over time), the Video Filter effect uses the same controls as the Dynamic Formation effect.

### To apply a mask area and filter:

1. Apply the **Video Filter** effect to your project.
2. Define the mask's shape by adding mask points on the playfield.
3. If you want it to change over time, select a tracking mode.

The controls for placing and tracking the mask are the same as those used in the **Dynamic Formation** effect. For details on how to use these controls, see [Dynamic Formation](#) <sup>1661</sup> effect.

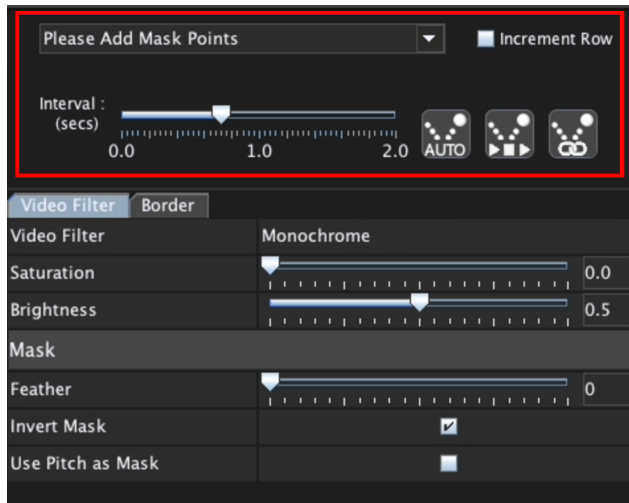

*Parameter Sheet - Dynamic Mask Controls*

4. In the Parameter sheet, open the **Video Filter** tab.
5. Select a filter (**Monochrome**, **Blur**, **Pixelate**, **Darken**, or **Lighten**) from the **Video Filter** drop-down.
6. Adjust the filter's properties using the available sliders (e.g., saturation, brightness, pixel size).
  - ★ Each filter provides unique options for customization.
7. In the **Mask** section, customize the mask using the following options:
  - **Feather**: Softens the mask edges for a seamless blend with the surrounding video.
  - **2D**: Select the checkbox to render the effect in two-dimensional format as needed for handling complex or un-keyable backgrounds.
  - **Invert Mask**: Reverses the masked area, applying the filter outside the mask instead of within it.
  - **Use Pitch as Mask**: Automatically applies the mask to the pitch boundary, isolating the play field and excluding areas like the crowd.
8. In the **Border** tab, adjust the **Line** style as needed.

# Virtual Ball



The Virtual Ball effect traces the path of a virtual ball from one point to another.

This effect requires [Calibration](#) <sup>[34]</sup> and a [Keyer](#) <sup>[32]</sup>.

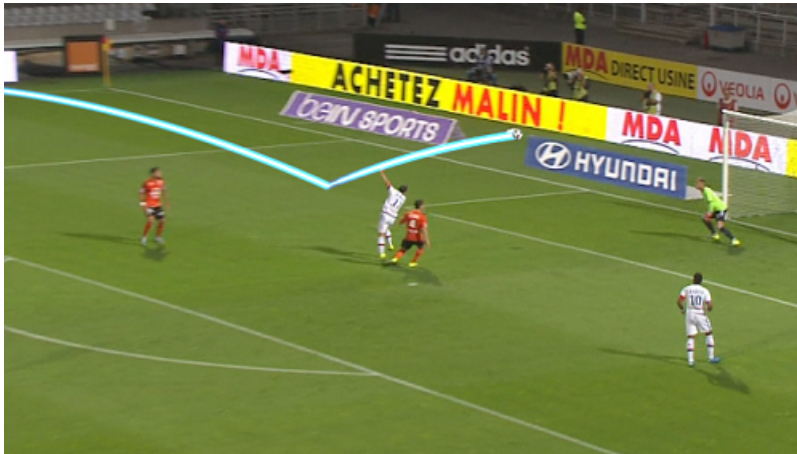

*Virtual Ball Effect*

## To use the Virtual Ball effect:

1. Add a **Virtual Ball** effect to the project.
2. Define the ball trail by clicking on the start/end points of the ball trajectory:
  - a. In the video, left-click on the ball and drag down to the ground.
  - b. Advance the clip to the next frame at which the ball is being kicked, hit, or thrown, left-click on the ball and drag to the ground.
  - c. Advance the clip to the frame where the ball hits the ground, a player, or is caught, and left-click on the ball again and drag to the ground.
  - d. If the ball is in the air at any point, left-click on it and drag down to the ground to create a smooth curve.
  - e. If the ball is on the ground the whole time, left-click on the ball midway through its path.
3. Refine the trail by adding intermediate points:
  - While the ball is in the air, press **Shift**, then left-click and drag to the ground to force the trajectory (curve) to pass through this point.

This is useful when the estimation is not working as expected.

★ Don't overdo this, as it can cause the movement of the ball or track to look jittery.



*Virtual Ball Effect - Adjust Trajectory*

4. In the property sheet, select the **BallTrack** tab and adjust the settings as needed:

- **Show Virtual Ball:** Toggle to display the virtual ball on the screen.
- **Keyed:** Use the checkbox to toggle the use of the RGB Key for the effect, applying it with or without the key as needed.
- **Show Handles:** Check to show the track handles.
- **Opacity:** Adjust the slider to set the track's opacity.
- **Transition:** Determines how the effect appears and disappears (e.g., Animate On, Mix Off).
- **Ball Model:** Choose a model for the effect, such as 'ChampionsLeague.'
- **Ball Radius:** Adjust the slider to set the radius of the virtual ball.
- **Rotating:** Toggle to enable rotation for the virtual ball.
- **Ball Marker:** Check to display a marker on the virtual ball.

5. In the **Trail** tab, from the **Trail Style** drop-down, select a style for the trail.

Upon selection, the settings specific to the chosen trail style will be displayed for configuration.

6. In the **Text Measure** property, adjust the measurement settings:

- a. From the **Text Measure** drop-down, select a measure to display the speed or distance traveled by the ball.

The speed is calculated as the speed of the ball through the air and the distance is calculated as the distance the ball has covered on the ground.



*Virtual Ball Effect - Speed and Distance Calculation*

- b. Select the **Show Changing Text** checkbox to display the measurement text throughout the movement of the ball or deselect it to display the text only after the ball has completed its flight.
- c. Add a pause at the end to allow enough time for the text to be read.
- d. Right-click on the video to place the text in the default position, relative to the ball's current position on the ground

**OR**

- e. Select the **Fixed Text Position** checkbox to keep the text at a chosen location.
- f. Scroll the mouse wheel to adjust the ball height.
- g. Press Ctrl and then scroll the mouse wheel to adjust the text size.
- h. Select the **Text** tab and adjust the text settings as desired.

### Mouse Controls

Mouse Action	Description
Left-Click	Define the ground point of start/end ball trajectory.
Left-Drag	Define the air point (off the ground) for start/end ball trajectory.
Right-click	Define the ground point of start/end ball trajectory for a pass on the ground.
Shift+Drag	Add intermediate key-point with auto-guessed height.
Mouse Wheel	Adjust height of ball at selected handle (or change text size).

# Virtual Camera



The Virtual Camera effect moves virtual cameras to provide other views of the action in a virtual stadium. The virtual cameras can be linked to a track to provide a path for camera movement.

This effect requires [Calibration](#) <sup>34</sup> and a [Keyer](#) <sup>32</sup>.

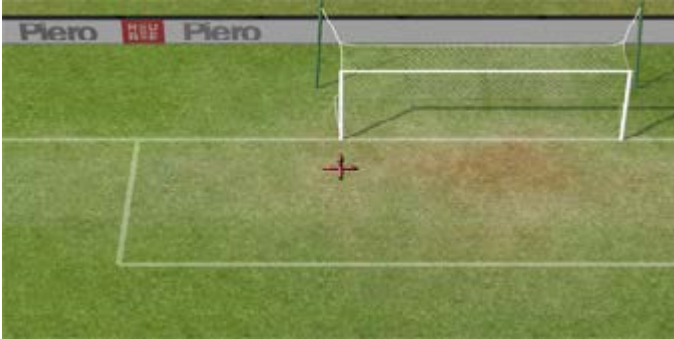

*Virtual Camera Effect*

## To use the Virtual Camera effect:

1. Add a Virtual Camera effect to the project.

A target appears in the video window, representing the current viewpoint. The camera locks on the current calibration position and overrides it. All effects will be placed under the Virtual Camera's perspective.

The virtual camera will interpolate to the target position during the transition **IN**.

2. Change the transition **IN** time of a virtual camera to change the movement speed.
3. Right-click to move the virtual camera closer to or further away from the target.
4. Left-click to move the virtual camera around the target.
5. Press mouse wheel (or middle button) to move the target on the pitch.
6. Press **C** at anytime to reset the camera position to the initial calibration position.

Additional controls are available in the top section of the property sheet, as shown below:

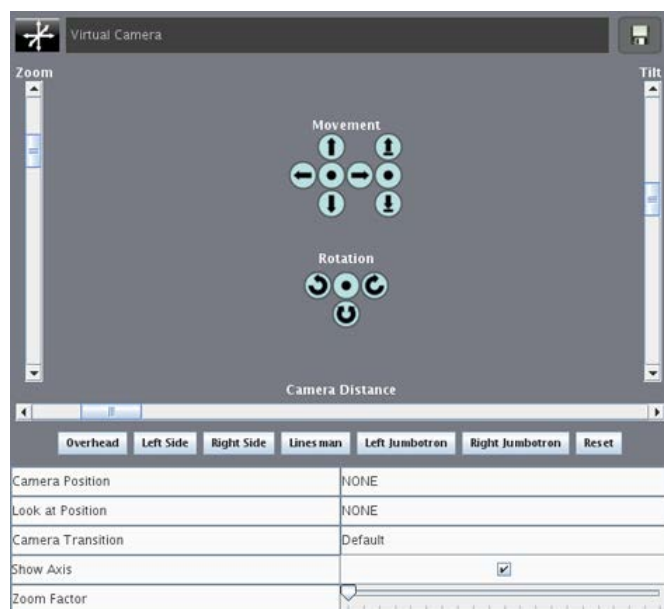

*Virtual Camera - Camera Controls*

The Zoom Factor option in the virtual camera determines the amount of bounce during transitions to that camera. This bounce helps conceal artifacts during transitions, which is especially important when using multicam setups.

- Use the pre-defined camera position buttons (Overhead, Left Side, Right Side, etc.) located under the Camera Distance scroll bar when attempting advanced effects such as Jumbotron mix and line man point of view replays.
- Link the Camera Position and/or the Look at Position to any tracking effect (Track, Markers, Spotlight, etc.) present in the project to produce advanced camera movements within the virtual stadium.

A typical project with 2 camera movements looks like the picture below:

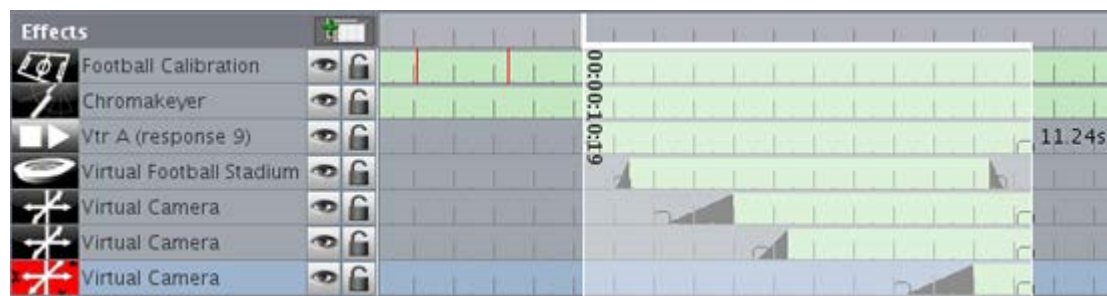

*Virtual Camera Effect Timeline Example*

The first and second virtual camera effects are moving in the virtual stadium and the third (selected) camera has been left on its default position allowing it to come back to the calibration position before the stadium is mixed off.

## Camera Transition: Alternative Route Option

By default the camera spins around the Z-axis. In some cases it might be useful to opt for the alternative shortest route to prevent collisions with the virtual stadiums or to ease morphing between different zooming values.

## Virtual Camera Live



The Virtual Camera Live effect allows multiple camera positions to be defined and selected, in Live mode only.

This effect requires [Calibration](#) <sup>[34]</sup> and a [Keyer](#) <sup>[32]</sup>.

### To use the Virtual Camera Live effect:

1. Add a Virtual Camera Live effect to the project.
2. At the top of the property sheet, select one of the numbered set of positions currently in use.

#### OR

Click **Add** to introduce an additional camera position.

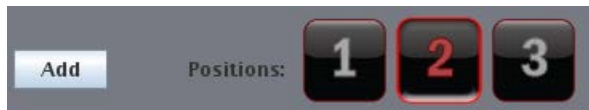

*Virtual Camera Live Positions*

Once selected, a camera position can be controlled in the same way as a normal virtual camera.

3. Make sure that you have a virtual stadium on air before using the cameras.
4. Click the **OFF** button to return to the real camera position.



*Virtual Camera Live Control Buttons*

★ Do not turn off the stadium before turning off the camera.

# Virtual Camera Spline



This effect makes the virtual camera follow a pre-defined path and allows for advanced camera movements.

This effect requires [Calibration](#) <sup>34</sup> and a [Keyer](#) <sup>32</sup>.

## To use the Virtual Camera Spline effect:

1. Add a **Virtual Camera Spline** effect to the project.
2. Adjust the camera position and look-at-point for the first keyframe as if it was a traditional PIERO virtual camera.
3. Click the **Add Keyframe** button to register this position.
4. Repeat this as many times as necessary to build the camera trajectory.
5. Click the **Add Pause** button to introduce a break of several seconds.
6. At the end, select the **Add Return Keyframe** button to add a final camera at the start position.

This brings the trajectory back to the calibration shot to transition out of the virtual stadium.

Each keyframe and pause is added to the list in the property sheet and has a corresponding red bar showing in the timeline to help you visualize the camera path.

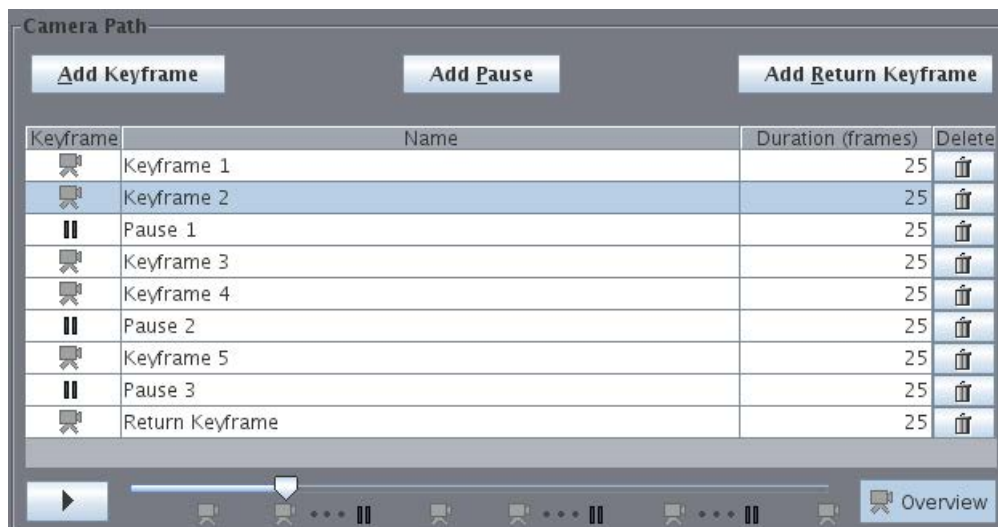

*Virtual Camera Spline - Property Sheet*

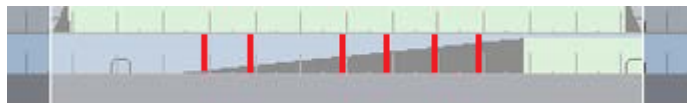

*Virtual Camera Spline - Timeline*

7. Once all the keyframes and pauses are in, adjust the **Duration** of each element to tweak the camera trajectory timing.
8. Click the **Play** button to preview the virtual camera spline movement.

**To adjust the spline trajectory:**

1. Click on the **Overview** button to activate **Overview** mode where it is possible to browse the 3D scene using the overview camera (not shown when playing live).
2. Click on a camera keyframe handle to select it and change it as shown in the image below.



*Virtual Camera Spline - Adjust Spline Trajectory*

Notice how pause points introduce inflection points in the trajectory (bottom of the image).

With this effect it is possible to build very complex camera movements to follow a player in an animated 3D scene or spin around a players' face in the EA FIFA module.

# Virtual Presenter

 The Virtual Presenter premium effect inserts the presenter onto the pitch in real time.

This effect requires [Calibration](#) and a [Keyer](#).

### To use the Virtual Presenter effect:

1. Before starting PIERO, make sure the **Mode** on the launcher is set to **Broadcast (Dual Input)**.  
The input 1 (sport video) and input 2 (green screen presenter) for the Virtual Presenter effect needs to have the same resolution and framerate as your main input video, for example HD 1080p (50Hz).
2. Start PIERO.
3. Calibrate and key the scene as usual.
4. Add a Virtual Presenter effect to the project.

If your system has the second input enabled you will see the following property sheet; if not you will receive an error message in its place.

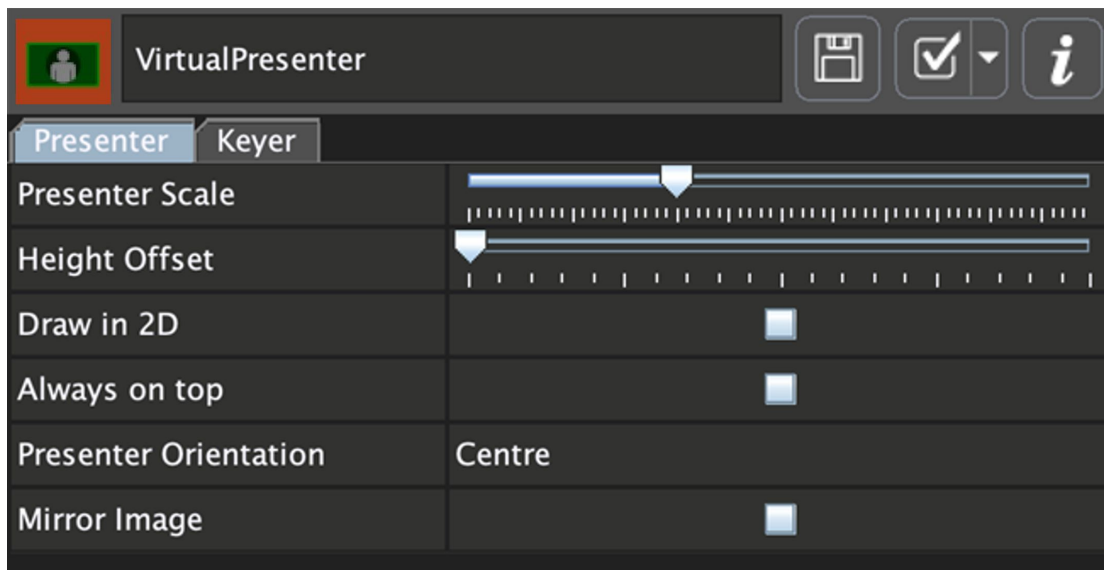

*Virtual Presenter Property Sheet*

- Position it on the pitch by clicking and dragging the red square handle located in the center of the graphic, which may be partially obscured by the presenter box. Adjust its properties as outlined in the table below:

Property	Description
<b>Presenter Scale</b>	Sets the relative size of the Virtual Presenter.
<b>Height Offset</b>	Sets the real world height of the billboard where the presenter is in 3D space. It will be auto-calculated the first time the presenter is keyed.
<b>Draw in 2D</b>	The presenter will be drawn in 2D. This is useful when drawing the presenter against the bottom edge of the screen.
<b>Always on top</b>	Normally the presenter will be either in front of or behind the players depending on its position on the pitch. With this setting the presenter will be always on top (in front) of all the players.
<b>Presenter Orientation</b>	Allows the presenter to face a specific direction or to face the current camera (Virtual Camera or the camera position selected when calibrating).
<b>Mirror Image</b>	Flips the image so that it is easier for the presenter to position themselves and interact with the scene.

- Click **Done** to register the changes and start using the virtual presenter.

## Using Audio

PIERO can forward the audio from the Virtual Presenter to any audio channel on the output.

### To use audio:

- Make sure that on the launcher you have selected an option other than **No Audio**.
- In the **Settings** tab of PIERO, select the drop-down beside the **2nd input Audio on** option to select in which channels PIERO embeds the audio of the Virtual Presenter.

The option looks like this:

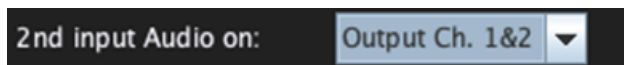

*2nd Input Audio On Option*

### NOTE:

PIERO does not mix the audio of SDI Input 1 with SDI Input 2. On the output, the audio from the Virtual Presenter is embedded on different channels. If the audio from the Virtual Presenter needs to be mixed with the audio from the main video, this must be done externally.

## Keying: Basic

The basic keyer works in a similar way to other keyers in PIERO. By left-dragging a rectangle over the background, the keyer receives enough color information to segment the foreground (presenter) from the background (chroma).

This keyer works as a vectorscope and not as an RGB Keyer. This means that it only supports a single uniform color for the background, such as green or blue; it does not support a background that has several distinct colors.

Select an active area or crop an area by using the right button of the mouse to drag a rectangle over the desired area.

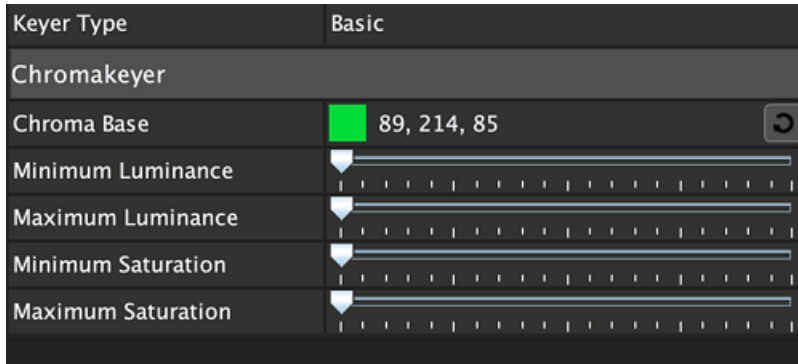

*Virtual Presenter - Basic Keying*

The properties of the basic keyer are as follows:



- **Chroma Base:** The main background color that the keyer is using for keying, with a button to reset this color.
- **Min/Max Luminance and Saturation:** These values are automatically populated as more background colors are added by dragging rectangles. They enable you to define the luminance and saturation of the background color that will be removed.

## Keying: Advanced Keyer (XPression)

The advanced keyer (or XPression keyer) mimics a full hardware keyer and allows for much more fine tuning than the basic one. It is ideal for more challenging scenarios where the background color might spill or fringe onto the presenter.

The **Chroma Base** (background color) can be defined by left dragging a rectangle over the background. This will also set the maximum angle. This process can be repeated to refine both values.

Select an active area or crop an area by using the right button of the mouse to drag a rectangle over the desired area.

Keyer Type	XPression
Chromakeyer	
Chroma Base	 89, 214, 85 
Max Angle	16.000°
Edge Width	2.000°
FG Clipping	20.000%
Edge Hardness	0.000%
Luma Clip Low	0.000%
Luma Clip High	100.000%
Luma Clip Softness	0.000%
Spill Supresion	
Range	100.000%
Desaturation	0.000%
Matte Processing	
Sharpen Range	0.000%
Sharpen	0.000%
Soften	0 pixels
Display	
Mode	COMPOSITION

### *Virtual Presenter - Advanced Keying (XPression)*

The properties of the advanced keyer are as follows:

- **Chroma Base:** The main background color that the keyer is using for keying, with a button to reset this color.
- **Max Angle:** The maximum hue angle for the background color. Increasing it will allow more colors to be keyed.
- **Edge Width:** Increases the width of the edge between the foreground and background. Altering this will affect the border around the presenter, reducing effects such as fringing.
- **FG (Foreground) Clipping:** Removes or includes lower saturated colors in the foreground image (presenter).

- **Edge Hardness:** Indicates the slope of the alpha gradient on the edge between foreground and background.
- **Luma Clip High/Low:** Controls the overall brightness of shadows, translucency and transition areas, as well as partial reflections.
- **Luma Clip Softness:** Indicates the slope of the alpha gradient on the edges of the luma clips.
- **Spill Suppression Range:** Spill suppression elements are pixels in the foreground that have a noticeable tint of the background color. This typically occurs around the edge of the foreground subject as glow from the background blue-screen or green-screen spills onto them. The range indicates how much of that suppression is applied.
- **Spill Suppression Desaturation:** In some cases, if the spill cannot be avoided, it is possible to desaturate the edge between the foreground and background to reduce the impact of the spill, this will affect the colors on the edge of the presenter.
- **Matte Processing (Sharpen Range and Soften):** These settings will blur (soften) or sharpen the whole background mask. This enables the removal of artifacts and can avoid the loss of detail in some cases.
- **Display Mode:** Changes the way the presenter is displayed in the preview window but won't change the output of PIERO.

The available modes are:

- **COMPOSITION:** In this mode, a red mist will appear over the area that will be removed (background).
- **MATTE:** Displays the mask with white for the foreground and black for the background, displaying partial transparency in grey.
- **SOURCE:** Displays the second video input unaltered. This is useful when checking the integrity of the colors.
- **PREVIEW:** Displays the presenter in perspective, on the pitch, so you can preview how it will look on the output.
- **REGION:** Displays the bounding box around the presenter. This is used to establish the ground plane of the Virtual Presenter.

# Virtual Stadium



The Virtual Stadium effect draws a 3D virtual representation of the stadium, allowing the action to be viewed from any angle.

This effect requires [Calibration](#) [34] and a [Keyer](#) [32]. You will also need to use the [Region Tool](#) [75] to define the players.

When created, the Virtual Stadium effect will be drawn at the same camera angle as the active calibration thereby allowing a seamless mix from the real pitch to the virtual stadium.



*Virtual Stadium Effect*

## To use the Virtual Stadium effect:

1. Add a Virtual Stadium effect to the project.
2. In the property sheet, adjust the properties described in the table below as required.

Property	Description
<b>Show Players</b>	Select to display the players found by the <b>Region Tool</b> at this timecode.
<b>Clip Distance</b>	Adjust to remove the stadium pitch side geometry closest to the camera, if this is clashing with the camera. 0 = 0 m from the pitch side.
<b>Roof Visible</b>	Select to make the stadium roof visible.
<b>Stadium Visible</b>	Select to make the stands, seating and crowd visible. Deselecting will show the playing field floating in space.
<b>Jumbotron</b>	Select the type of Jumbotron required for the 3D stadium. It can play the current input, allowing real pictures to be combined with the virtual stadium or a still image from the event folder located under <b>Graphics</b> on the PIERO desktop.
<b>Sky Type</b>	From the drop-down, select a sky type that matches the current time of day. You can also display a 2D image behind the stadium or incoming video.
<b>Grass Texture</b>	From the drop-down select a texture to adjust for the grass. Sometimes it is more realistic to use a grass color closer to the average color of the current active <b>RGB Keyer</b> . Select one of the chromakeyed textures in this case.

Property	Description
<b>Add Mud</b>	Add a default mud texture.
<b>Advert Group</b>	To change the boards around the stadium, select assets in the <b>stadiums/brand name/adverts</b> folder. Each board is a 512 x 128 pixel <b>.tga</b> file.  You can add sub-directories with more boards. The sub-directories are automatically picked up and listed under the <b>Advert Group</b> property.

## Touch Mode

In touch mode, you can touch different parts of the pitch (football and AFL) to move the virtual camera's position to focus on the selected area (only certain areas can be selected).

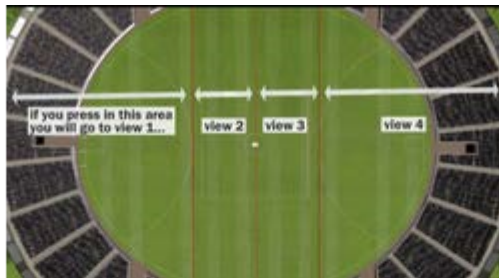

*Virtual Stadium - AFL Overview*

# Zoom



The Zoom effect zooms in or out on a specific point of the screen.

This effect requires [Calibration](#)<sup>[34]</sup> and a [Keyer](#)<sup>[32]</sup>.

The Zoom effect is a 2D effect that can be used with any video footage.



*Zoom Effect*

## To use the Zoom effect:

1. Add a Zoom effect to the project.
2. Left-click on an area to zoom in.

For workflow reasons, the Zoom effect only shows the zoomed in area when selected in the timeline.

3. Right-click on an area to zoom out.

# Modules and Utilities

Modules and utilities are found on the PIERO Launcher (represented by icons). Some features are included in all PIERO systems, while others must be purchased individually.

[Asset Manager](#)  257

[Data Visualization Module: Soccer \(Football\) and Rugby Union](#)  (included with PIERO Live, purchased separately with PIERO Broadcast)

[Sportscode XML Importer](#)  (only available in PIERO Club)

[Video Test Tool](#)  (only available in PIERO Broadcast and PIERO Live)

[License Utility](#)  280

# Asset Manager

The Asset Manager provides a set of tools to manage the assets (textures, movies, squads) used by PIERO effects, as follows:

[Import/Export](#) <sup>[257]</sup>

[Add Custom Assets](#) <sup>[260]</sup>

[Teams](#) <sup>[257]</sup>

[3D Players](#) <sup>[257]</sup>

[Maintenance](#) <sup>[257]</sup>

[Back Up](#) <sup>[266]</sup>

## To open the Asset Manager:

1. Launch PIERO.
2. Select the  **Asset Manager** icon on the launcher.

The **PIERO Asset Manager** opens.

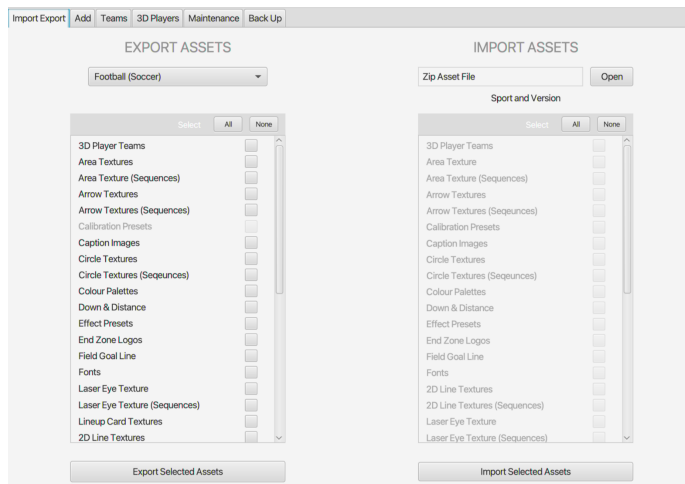

*PIERO Asset Manager*

## Import/Export Assets

In the **Asset Manager**, through the **Import/Export** tab, users have the flexibility to export and import a selection of assets across one or more sports. These assets are packaged into a compressed archive with the extension **.PIEROzip**. To transfer previously imported assets to another PIERO machine, the **Export Asset** feature is utilized, and the corresponding **.PIEROzip** file can then be imported using the **Import Asset** feature on the second machine. However, if the goal is to introduce a new asset that has not been previously imported, such as a PNG file, this must be done using the **Add Asset to PIERO** <sup>(260)</sup> feature, located under the **Add** tab.

### To export an asset:

1. In the **EXPORT ASSETS** column, from the drop-down, select the sport from which you want to export assets.
2. From the export list, select the relevant assets and select **Export Selected Assets**.

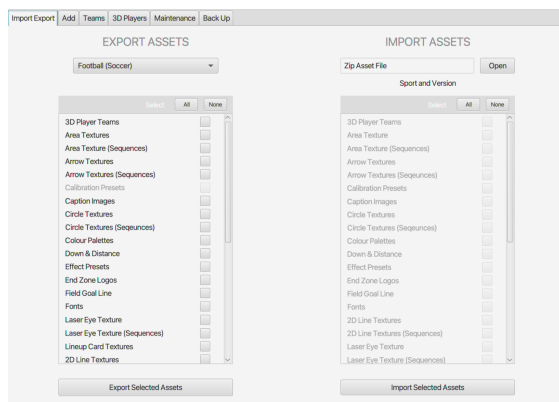

*Asset Manager - Exporting Assets*

The **Save As** window opens.

3. In the **Save As** field, enter a name for the file.
4. From the **Tags** drop-down, select the Tag you want.
5. From the **Where** drop-down, select the desired location to save the file.
6. Select **Save**.

The assets are exported to the desired location.

## To import archived assets:

1. In the **IMPORT ASSETS** column, select **Open**.
2. In the file explorer, navigate to the archive containing the assets you would like to import and select **Open**.
3. From the **Import** list, select the relevant assets and select **Import Selected Assets** to copy the files from the archive to the relevant PIERO folders.

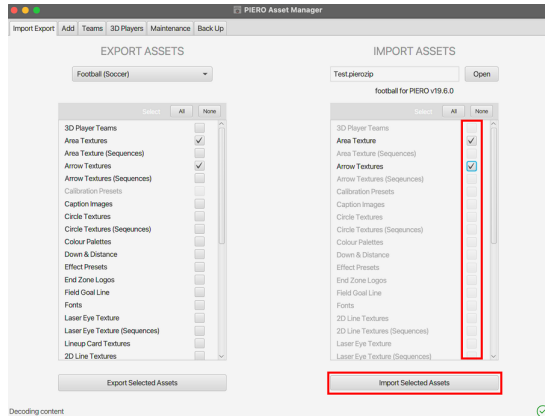

### *Asset Manager - Import Assets*

Imported textures, movies, and teams will overwrite existing assets with the same file name. Assets with different names will not be overwritten by this operation.

A confirmation or error message will appear in the status bar in the bottom-left corner of the window.

## Add Custom Assets

The **Add** tab allows users to add custom assets to PIERO. When an asset is selected from the list, detailed information about the asset format—such as resolution, aspect ratio, file type, and more—will be displayed based on the selected effect. Within the **Add** tab, users can perform several key actions: adding a new asset, viewing the asset directory in its folder, and, depending on the asset type, adding a sequence folder to PIERO. This provides a streamlined approach for managing and organizing assets efficiently.

★ **Important:** Imported Assets must follow the specifications given in the Asset Manger.

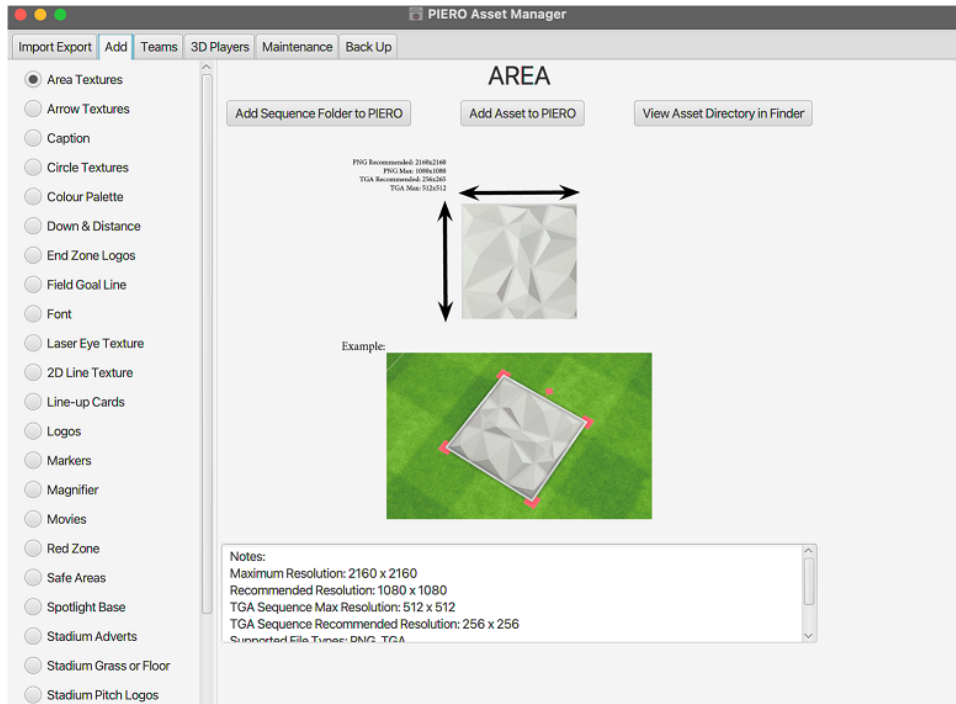

Asset Manager - Add Tab

## Adding Custom Assets

This section details how to add custom assets.

### To add a custom asset:

1. From the **Add** tab, select an existing asset from the list on the left side of the window to which you want to add a custom asset.
2. Select the **Add Asset to PIERO** button.
3. In the folder browser, navigate to the custom asset you want to add and select **Open**.

The folder browser closes and returns to the **Add Tab**. The selected asset is added to the asset directory.

### To add sequence folders to PIERO:

1. From the **Add** tab, select the **Add Sequence Folder to PIERO** button.
2. In the folder browser, navigate to the folder you want to add and select **Open**.

The **Import Success** dialog opens, confirming the folder has been successfully added.

3. In the **Import Success** dialog, select **Close**.

The **Import Success** dialog closes and the sequence folder is added to the asset directory.

**To see the Asset Directory containing the asset:**



- From the **Add** tab, select the **View Asset Directory in Finder** button.

## Teams

In the Asset Manager's **Teams** tab, users can create and customize teams, each comprising a list of players representing the squad. Teams can be generated based on the sport, providing flexibility in team management. The **Teams** tab functions as a centralized hub for defining and configuring team and player details, streamlining the setup process for various effects such as Team Lineup, Text, and Caption effects.

This section provides instructions on how to complete these tasks manually. However, a more efficient approach is available: in the bottom row of the UI, you can import a team from a **.txt** or **.csv** file, swap **Names**, auto link images (portraits) to players by matching file names with player names, and finally save the current team configuration. This method is recommended over manually entering each value.

### To add or remove leagues and teams:

- Select the  button to add a league or team.
- Select the  button to remove a league or team.

The drop-down menus show the list of existing leagues and teams.

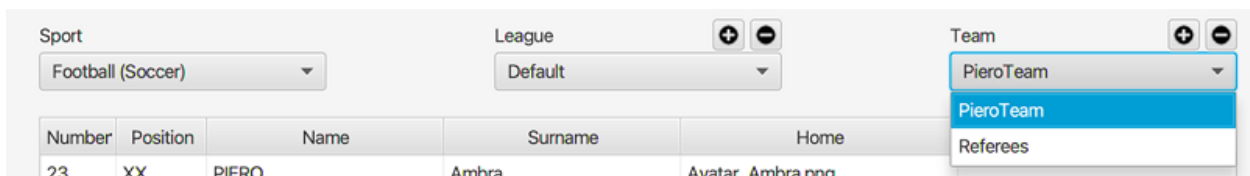

*Asset Manager - Add/Remove Leagues and Teams*

### To edit player info:

1. Double-click on a cell in the player table and enter new player info (Number, Name, and Surname).
2. Double-click on a cell in the **Position** column and select the position from the drop-down.

Player positions vary with the sport.

Number	Position
23	XX
69	
11	GK
3	DF
15	MF
7	FW
5	XX
10	XX

*Select Position*

3. Press **Escape** when you've finished editing.

### To add Away and Home images:

1. Double-click on the **Home** or **Away** cell.
2. In the **File** browser, navigate to and select the image you want to use.

These images are used in the [Caption Track](#)<sup>[149]</sup> and [Team Line-up](#)<sup>[219]</sup> effects.

Number	Position	Name	Surname	Home	Away
23	XX	PIERO	Ambra	Avatar_Ambra.png	
69	XX	PIERO	Andrea	Avatar_Andrea.png	Avatar_Andrea_Away.png
11	XX	PIERO	Bradley	Avatar_Bradley.png	
3	XX	PIERO	Isabelle	Avatar_Isabelle.png	
15	XX	PIERO	Julian	Avatar_Julian.png	

*Asset Manager - Add Images*

### To add a new player manually:

1. Select or enter the information in the row directly below the player table.

10	GOALKEEPER	Name	Surname	Add Player
----	------------	------	---------	------------

*Asset Manager - Add Player Manually*

2. Select **Add Player**.

The new player is added to the list of players.

## 3D Players

The 3D player tab is used to create team outfits (home/away kits, strips). The 3D Player and Team Line-up effects use the 3D players outfits.

3D players are available for:

- Aussie Rules Football
- Basketball
- Football (Soccer)
- Gaelic Football
- Hurling
- Ice Hockey
- Netball
- Rugby (League and Union)
- Tennis
- Handball (for the team line-up only)

### To create a team outfit:

1. From the drop-downs across the top of the tab, select a **Sport, League** and **Team**.
2. Then select an **Outfit** or create one for the appropriate type of player.

Strips can differ between goal keeper and players.

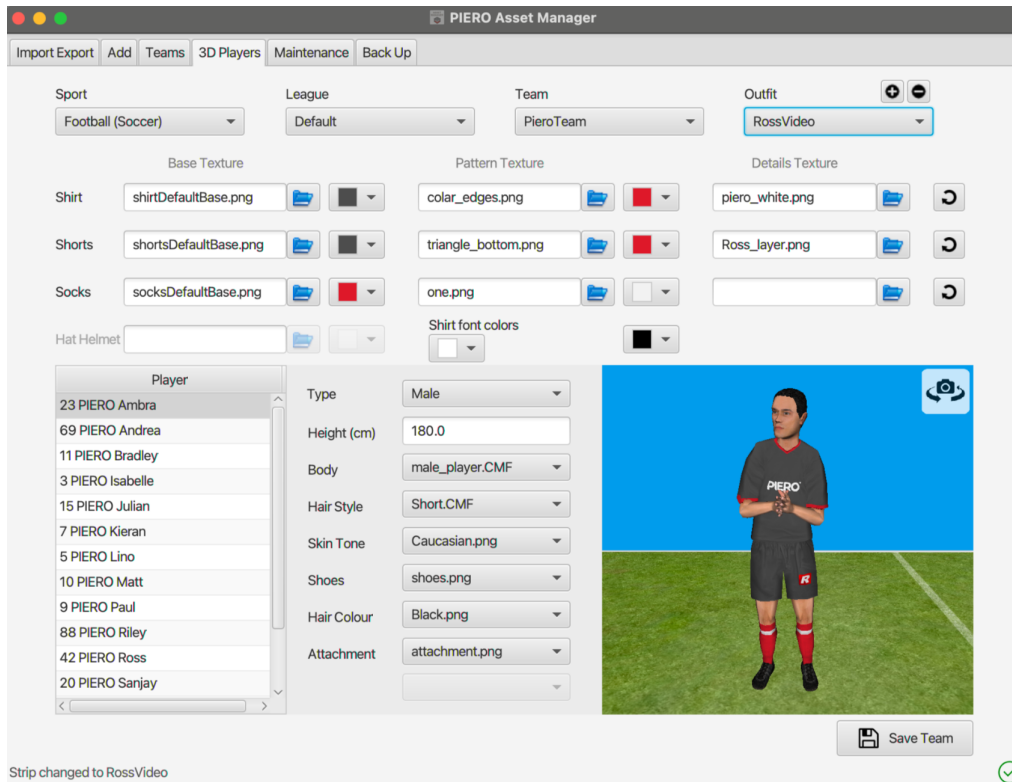

Asset Manager - 3D Players Tab

3. Click and drag inside the **Preview Window** on the bottom-right to change the preview angle and focus on a specific side of the player.
4. If the outfits haven't been pre-generated:
  - Select a **Shirt, Shorts, Socks** and **Hat/Helmet** (if applicable) from the **Base Texture** drop-downs.
  - Select a pattern such as stripes or hoops from the **Pattern Texture** drop-downs.
  - Apply a color overlay to each selection.

Long sleeves require a different 3D model than the default one. Select the **longsleeveplayer.CMF** from the player's **Body** drop-down list. Then use the **shirtDefaultLongSleeve.png** texture as a base model for the strip.



## Customize Player Appearance

It is possible to customize each player's attributes such as skin, hair, shoes etc. Several pre-made textures and meshes are available to fully customize the players' appearance and it is possible to add more textures to complement the existing ones.

You can create all the strips in Adobe Photoshop and use them as a base or start with a white base and add color to it.

There can be several strips per team.

### To create a new strip:

1. Click on the  icon above the **Outfit** drop-down.  
The **Create new outfit strip** dialog opens.
2. Enter a unique name for the new strip and select **OK**.
3. Beside each item (Shirt base, Shorts base, etc.), select the  **File** button.
4. In the file browser that opens, navigate to the folder containing the base texture you want to use and select **Open**.
5. Click the color picker drop-down beside each item to select a custom color.

You can now apply your custom strip to a team.

## Maintenance

The **Maintenance** tab should be used with the help of the Ross Video Support team to clear effect presets from an old version, verify the validity of color palettes and reset some application settings. The Ross Video support team might also ask you to use it in order to zip up the application's hidden settings.

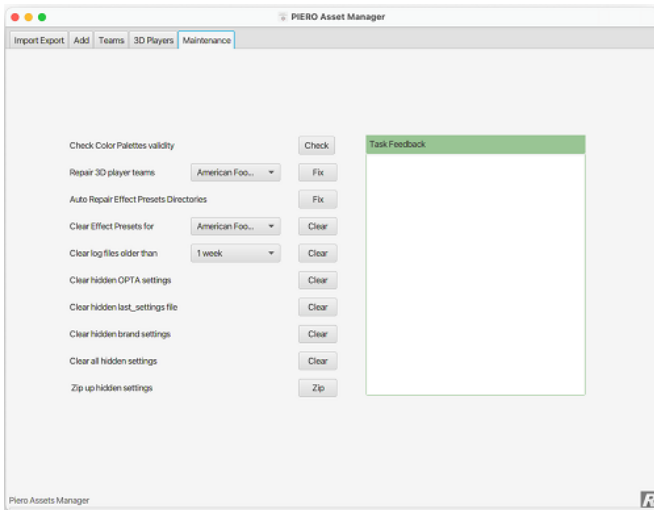

Asset Manager - Maintenance Tab

## Back Up

The **Back Up** tab provides access to the tools necessary for backing up and restoring your PIERO assets.



**CAUTION:** Do not use the **Back Up** tool across major versions (e.g., backing up in V17 and then restoring in V19). However, you can import/export assets between major versions.

## Back Up Assets



**WARNING:** Clips stored outside of the designated **PIERO Clips** folder will not be included in the backup process. If you have a significant number of clips in other folders, it is highly recommended to back those up separately. This will help avoid creating a single, large, heterogeneous zip file.

Before you begin, ensure the following:

- Ensure that all of the data you want to back up is located in your default folders; this should already be the case if you have used only the asset manager to manage your assets. For clips, only media within the **PieroSource** and **PieroExport** folders will be exported. If you have data you want to export that is outside of the default directories, you will need to move it to the default folders or backup the data manually.
- Ensure there is enough space on your hard drive to store the exported data. In the PIERO Asset Manager, the approximate size of each asset is displayed to the right of each asset. To determine the storage space required to export the assets, use these approximations. The back up will likely produce a large file, if you want to copy this onto a USB drive, we recommend using the exFAT file format.
- **★ Important:** During the backup and restore process, refrain from opening other tabs or running additional programs on your computer to ensure optimal performance and prevent potential issues.

## To back up assets:

1. In the **PIERO Asset Manager**, select the **Back Up** tab.

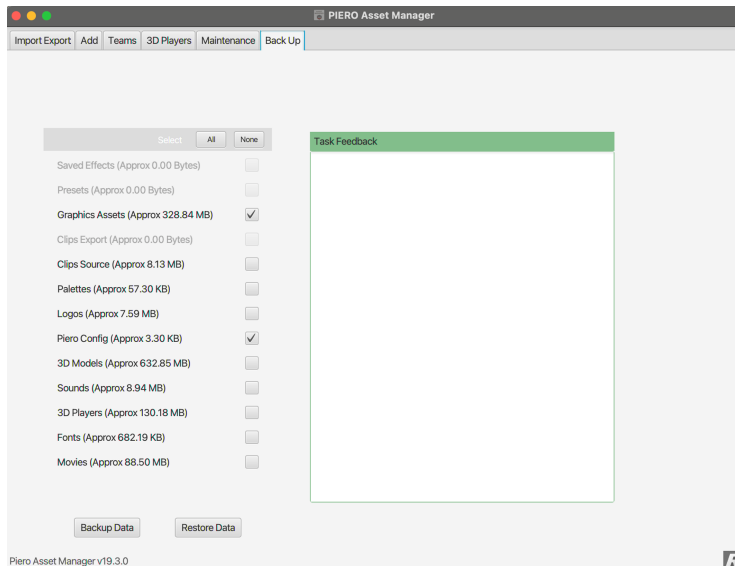

*PIERO Asset Manager - Back Up Tab*

2. From the list, select the assets you want to back up.

The assets automatically selected in the list are the recommended assets for export. Additional assets can be selected or deselected from the list as needed.

3. Select **Backup Data**.

A new window opens.

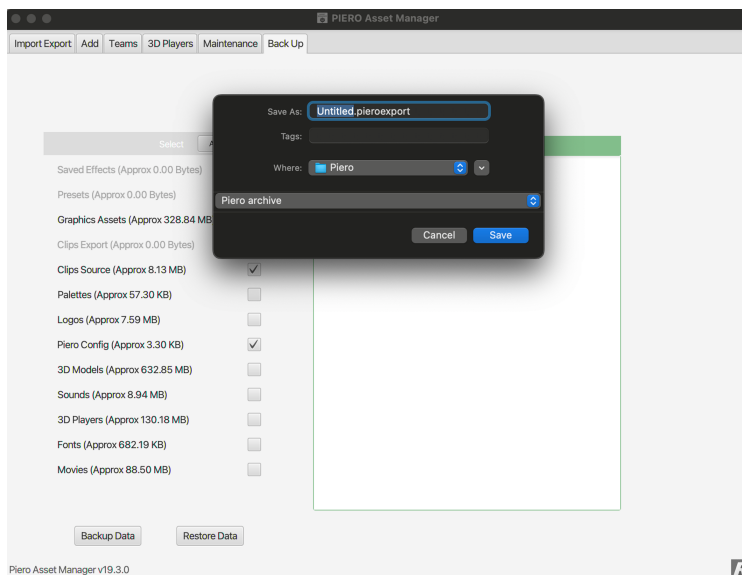

*Window - Export Options*

4. In the **Save As** field, enter a title for the export file.
5. In the **Tags** field, enter a tag to add to the file to make it easier to find (MacOS only).
6. From the **Where** drop-down, select the directory where you want the back up to go to.

- From the last drop-down, select **Piero archive** (default).
- Select **Save**.

The window closes and the export process starts.

Users can follow the back up and restore progress using the progress bar, which incrementally advances with each completed file. While processing large video files, it may take a while, and the progress bar may appear like it isn't processing. The progress bar will jump forward when the large file has been processed.

Once the export is complete, the results are displayed in the **Task Feedback** panel. Additionally, any errors during the backup and restore process will be indicated in the **Task Feedback** window, which will also provide information on how to resolve the errors.

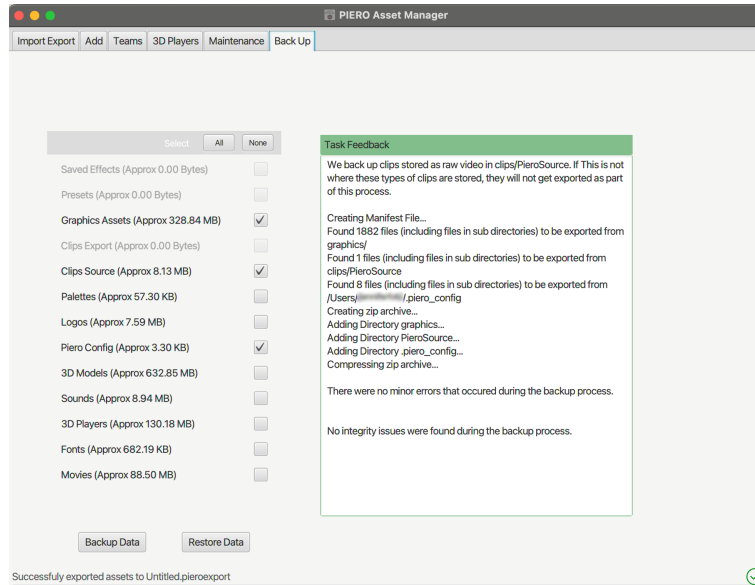

### *Task Feedback - Back Up Results*

The assets have been exported as a **.pieroexport** compressed file and saved to the location you selected.

## Restore Assets

Once you have exported your assets, you can now restore them.

**To restore assets:**

1. In the **PIERO Asset Manager**, select the **Back Up** tab.
2. In the **Back Up** tab, select **Restore Data**.

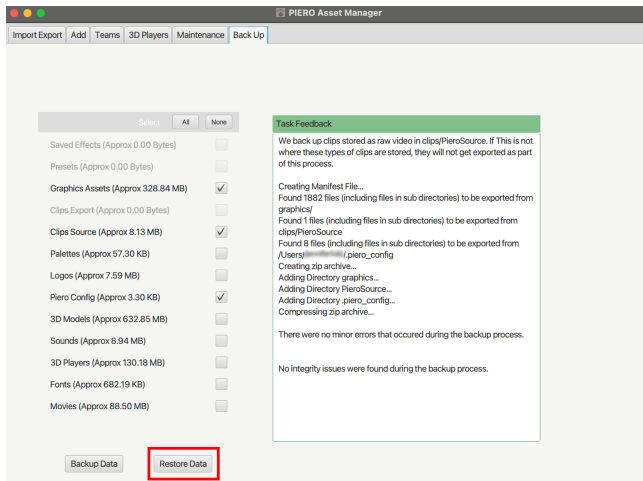

*Back Up Tab - Restore Data*

The File Explorer opens.

3. Navigate to the **.pieroexport** file.
4. Select **Open**.

An **Import Warning** dialog opens, indicating the items that will be restored.

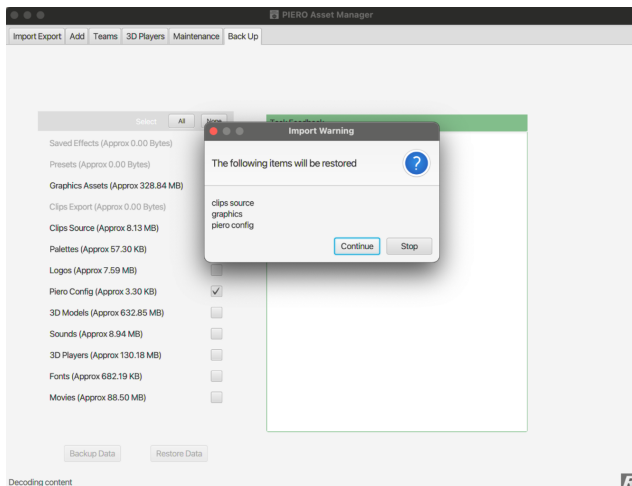

*Import Warning Dialog*

5. Select **Continue**.

The restore process begins.

Once the restore process is complete, the results are displayed in the **Task Feedback** panel.

Additionally, any errors during the backup and restore process will be indicated in the **Task Feedback** window, which will also provide information on how to resolve the errors.

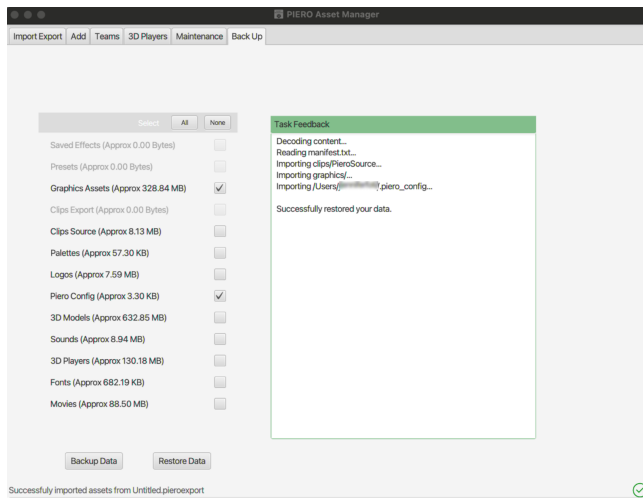

### *Task Feedback Panel - Restore Results*

The restore process is complete and the PIERO system is ready to use.

# Data Visualization Module: Soccer (Football) and Rugby Union



The **Data Visualization Module**: Soccer (Football) and Rugby Union module generates graphics from Opta, TRACAB or STATS data. Available as a paid-for add-on. Does not include data feed access.

★ OPTA is a third-party product, and an OPTA account must be purchased directly from OPTA in order to access its services and features.



Opta Data Module Interface

## To set up and connect:

★ Before you begin, make sure you have your OPTA login credentials available, as you will need to enter them in the settings window the first time you use the application.

1. Select your sport from the list of sports in the Launcher, then select the **Data Visualization Module** icon to start the associated data module.

**Note:** Opta statistics are based upon ball touch events.

The **PIERO Data Visualization** window opens.

2. Adjust the **Internet Connection** parameters in the **Settings** menu (top-right).

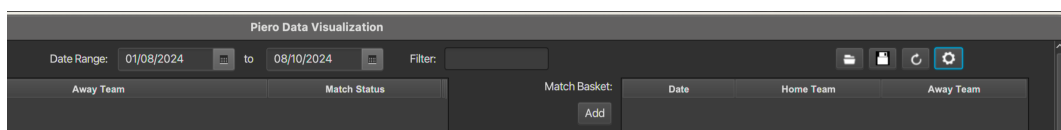

Data Visualization Module - Settings Menu

3. Once connected, select the league you are interested in from the **Competition** menu.

PIERO will download the match statistics based on the competition you select along with the date and season filters, with the possibility of further refining.

## Match Selection

You can filter the match data and then add matches to the Match Basket and select graphics to be added to the output.

### Filtering

By selecting the competition, season and date range, you are filtering what data is available. It is possible to further filter the data by using the text filter box to filter by team. You can also filter by using the headed sections under **Match**. It is also possible to choose to filter data by the area of the pitch the event took place in, the controls for this are located around the edge of the pitch preview

### Historical data

It is possible to use data not only from the current season but also from previous seasons, with the ability to analyze data from across multiple seasons. You can do this by selecting a season, putting further filters in place and then adding it to the **Match Basket**.

### Match Basket

Click on a match and then select **Add in the Match Basket** box to add the match to the **Match Basket**. Add as many matches as you want to the **Match Basket** from any season you can access. The selection in the **Match Basket** remains there while switching between seasons.

Click **Edit** to alter the selection in the **Match Basket**.

Click **Use** to amalgamate the data and place a preview in the data preview area below. It can then be used in the same way data from a single match is used.

You do not need to add a match to the **Match Basket** if you are only using the data from that single match. Just select the match you want, then select the graphic and the data.

## Data Graphics

Graphic	Description
<b>Touch Map</b>	A representation of all the ball touches for the selected player(s) It is possible to use standard markers or a 3D ball to visualize the graphics in PIERO.
<b>Heat Map</b>	A heat map for the selected player(s) based on where their ball touches were. In OPTA, there are variations available, so you are not limited to selecting based solely on touches.
<b>Pass Map</b>	A heat map for the selected player(s) based on where their ball touches were.
<b>Shot map</b>	A representation showing the location where the ball was kicked from and where it landed in the goal.
<b>Set Pieces</b>	Allows selection of corners and/or free kicks.
<b>Build Up</b>	Shows the build up to a goal. Select the goal and the number of passes to visualize.
<b>Formation</b>	Average formation. The names are re-sized according to how many times the player touched the ball. The position of each player is an average of all the touches during the selected time frame.

<b>Graphic</b>	<b>Description</b>
<b>Attack</b>	The attack pattern for the selected players divided in 3 columns (Left wing, Middle, Right wing).
<b>Story</b>	Allows you to configure multiple graphics for one player and send them all over to the PIERO application.
<b>Tracks</b>	Take TRACAB or STATS data and rapidly create tracks with it.
<b>Chalkboard</b>	Recreate the game in 2D/3D using TRACAB or STATS data.

★ Use the  **Refresh** button to get the latest data available for a live match.

## Output to PIERO

Once the desired data has been selected and filtered, the information needs to be sent to PIERO.

### To send data to PIERO:

1. Select the **New Project** checkbox to create a new project in PIERO with a virtual stadium, a virtual camera and data representation (this will clear the effects currently present in the PIERO project).

#### OR

Clear the **New Project** checkbox to send each data effect individually.

2. Press **Alt + Tab** to see the result in PIERO.
3. Click **Configure Send** to select which effects you want to be part of your Opta project.

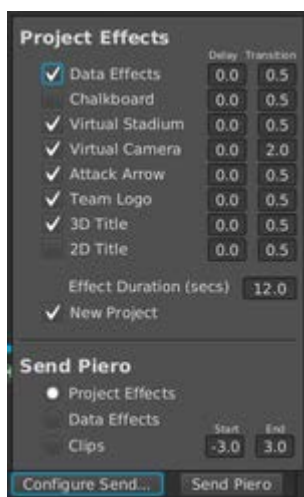

*Data Visualization Module - Output to PIERO*

You can also set the delay, transitions times and effect duration here, leaving less work to do it in the PIERO application.

4. Select **Project Effects** to send effects to the PIERO application as they have been configured in **Configure Send....**

#### OR

Select **Data Effects** to only send effects that represent data (e.g., markers or heat map).

By default, graphics with the **Smooth Animation** option animate at the **Animation Interval(s)**. If **Smooth Animation** is selected, the graphic animates continuously throughout the selected time range as the data changes.

## Timeline and Event Navigation

Use the timeline to filter the data in match time and use the attached events to navigate the video.

### To filter by time:

- Define a time filter in one of the following ways:
  - Drag the end points of the time line to change the selection.
  - Edit the text boxes at either end of the timeline.
  - Click on the whistles to select the 1st or 2nd half of the match. To select the 2nd half, press **Ctrl** and select the middle whistle.

### To set up navigating by event:

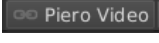
1. Load a full match corresponding to the data into PIERO.
2. In PIERO, navigate to the starting whistle.
3. Press the  button to mark the beginning of the match in Opta and synchronize the data.
4. Press the  button to be able to control the video from the Opta module
5. Click on the event icons on the Opta timeline to navigate to them in the video.



Timeline Event Icons

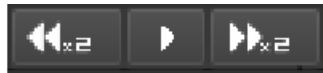

Opta VTR Control Buttons

6. Click on the events on the field to navigate to them in the video.

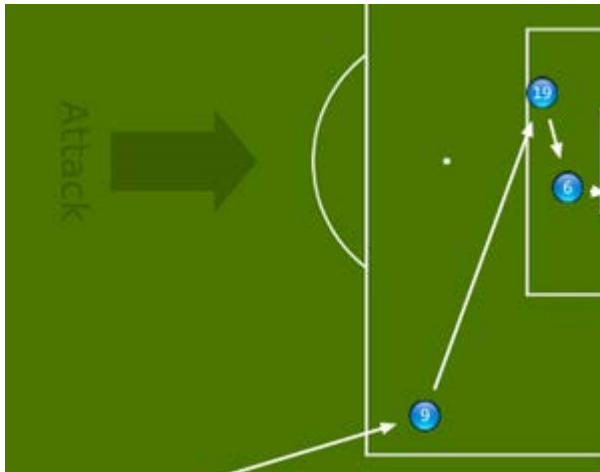

Data Visualization Module - Navigating by Event

### To load TRACAB or STATS data:

1. Select the **Competition** and **Season** (uses Opta data).
2. Select a match or use the folder icon in the top-right to load an **Opta F24.xml** file for a game.
3. Load a **TRACAB** or **STATS** data file (**.dat**) for the same match, using the folder icon in the top-right.

**To create tracks from TRACAB or STATS data:**

1. Load the full, wide-angle, match video into the main PIERO application.
2. Link the data to the video using the navigating by event setup.  
See [To set up navigating by event: !\[\]\(8863680de736979d113a19314accdd6f\_img.jpg\)](#) for instructions.
3. Use the **Tracks** tabs to send over the tracks you want, at the times you need them.

# Sportscodes XML Importer



This module allows you to integrate PIERO into your Sportscodes workflow.

Extract the clip data from a Sportscodes .xml file with the PIERO Sportscodes XML Importer and automatically recreate the clips in PIERO that were defined in Sportscodes. Export the finished video from PIERO and re-import it into Sportscodes complete with XML to recreate the clips.

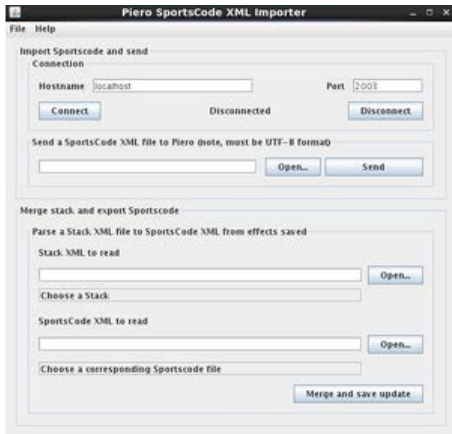

*PIERO Sportscodes XML Importer Interface*

## To import video with XML from Sportscodes:

1. Put the video exported from Sportscodes in the **Clips PIERO Source** folder.
2. Launch PIERO.
3. Load the video exported from Sportscodes as you would load any video in PIERO.
4. Switch back to the launcher by pressing **Alt + Tab**.
5. Click the **Data Module** icon to open the Sportscodes XML Importer.

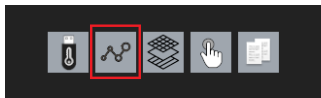

*Data Module Icon*

6. Click **Connect**.
7. In the **Import** section use the **Open** button to find the **Sportscodes.xml** file associated with the Sportscodes footage.
8. Click **Send**.

This sends the data from the Sportscodes .xml file to PIERO. Now you will see all of the clips in PIERO. These have been created from the data in the Sportscodes .xml file. The clips produced correspond to the clips made in Sportscodes and have the same naming.

## To export video with XML from PIERO:

1. Record the finished PIERO video as you normally would with any PIERO video
2. Save the project that corresponds to this video.

3. Switch back to the Sportscode XML Importer by pressing **ALT + Tab**.
4. In the **Merge Project and export Sportscode** section, select the **Open** button corresponding to the Project XML to read subsection.
5. Select the project corresponding to the video that has just been created in PIERO
6. Beneath this subsection in **Sportscode XML to read**, select **Open** and select the original **Sportscode.xml** file that was initially imported into PIERO.
7. Then select the **Merge and save update** button.

This will produce a new **Sportscode.xml** file including the new PIERO information.

The pauses in PIERO need to be translated into Sportscode in order for the initial metadata from Sportscode to remain aligned with the new video created by PIERO.

8. Import the PIERO-created video back into Sportscode (optional).

# Video Test Tool



This module is used to troubleshoot PIERO's SDI and RS-422 connections.

★ **Important:** The Video Test Tool only works with AJA systems and not with Matrox.

Use the Video Test Tool to help diagnose any video, audio, time code or video server control issues you have.

The Video Test Tool can give you information on the following:

- Video definition, frequency and activity on inputs SDI A and SDI B.
- Reference
- Audio (yes/no)
- Frame delay on input and output
- Number of dropped frames
- Timecode
- Video control over 422

Launch the Video Test Tool and check which of PIERO's connections are active and what is being received.



## Video Test Tool Interface

### To use the Video Test Tool:

1. Double-click the PIERO icon on the desktop to open the Launcher.
2. On the Launcher, select the  **Video Test Tool** icon.
3. Once open, the interface will display the video input on **SDI A** and overlay it with all the information the Video Test Tool is capable of providing.
4. Test if you have remote control of the video server by pressing **P** to play the video and **Spacebar** to pause it.

# License Utility



This module is used to update your USB license dongle or software license.

## Overview

The License Utility module, **Piero License Tool**, is used to create a new software license, update an existing USB or software license, or move a 'floatable' software license between PIERO systems.

A USB license dongle or a software license is required to use a PIERO system.

A software license is created to work on a specific PIERO computer.

A software license may 'floatable' which allows it to be moved between PIERO computers. Floating software licenses must be updated regularly to keep them valid.

If a USB license dongle is plugged into a PIERO system that already has a software license, the USB license dongle will be used and the software license ignored.

★ Certain buttons related to software licenses will not be visible if you only have a hardware dongle.

## User Interface Overview

The below image shows the Piero License Tool user interface.

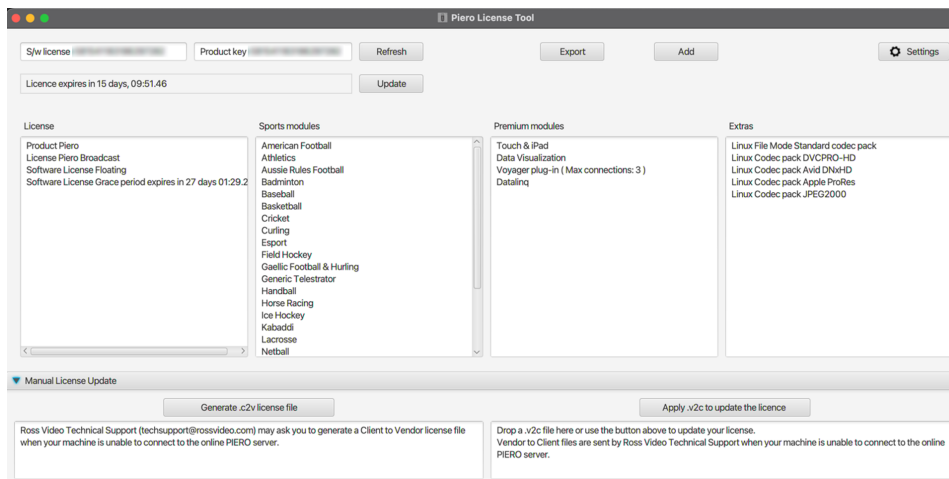

### *Piero License Tool*

**Settings** – Holds Internet access proxy details.

**Refresh** – Updates the User Interface.

**Update** – If connected to the Internet, this updates a USB license dongle or software license, with latest sports, expiry date, and if a software floating license is in use, also updates its grace period.

**Export** – Exports (i.e. removes) a floating software license from the PIERO computer using it, so it can be moved to a different PIERO computer.

**Add** – Allows a new software license to be added (internet online or offline) or a floating software license to be imported.

**Manual License Update** – Allows updating of the USB license dongle or software license, when internet access is not available.

# Settings

If your access to the Internet is via a proxy you can enter it's details using the **Settings** button. The proxy must be of type SOCKS and use proxy port 9000. The type is typically set to **Basic**.

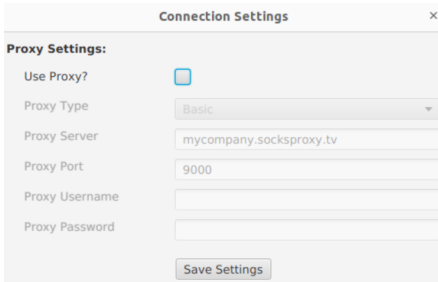

*License Utility - Connection Settings*

# Software License – Create and Install on PIERO Computer

If you haven't already done so, contact [techsupport@rossvideo.com](mailto:techsupport@rossvideo.com) and request a product key code, which is of the form XXXXX-YYYYY-ZZZZZ.

## Online

If you have access to the Internet, use the following procedure to create and install the software license on a PIERO computer.

### To add the software license on a PIERO Computer - Online:

1. In the PIERO **License Tool**, select the **Add** button, type in the product key code, and select **Fetch License**.
2. Close the Launcher, and then re-open it normally to run PIERO.

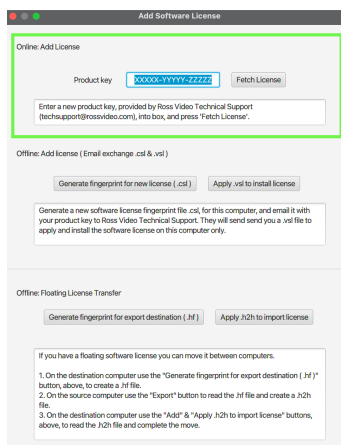

*Add Software License - Online*

## OFFLINE

If you do not have a connection to the Internet, a new software license can be added using an exchange of files with [techsupport@rossvideo.com](mailto:techsupport@rossvideo.com).

### To add a new Software License - Offline:

1. Run the **Piero License Tool** on the specific Piero computer where you wish the new software license to be used, select **Add**, and then select **Generate fingerprint for new license ( .csi )**. This will create a **.csi** file which you email to [techsupport@rossvideo.com](mailto:techsupport@rossvideo.com).
2. Tech support will then email you a **.vsl** file.
3. Select **Apply .vsl to install license** and then select the **.vsl** file.

★ **Note:** The **.vsl** file will only install a software license on the specific Piero computer where the **.csi** was created.

4. Close the launcher, and then re-open it normally to run PIERO.

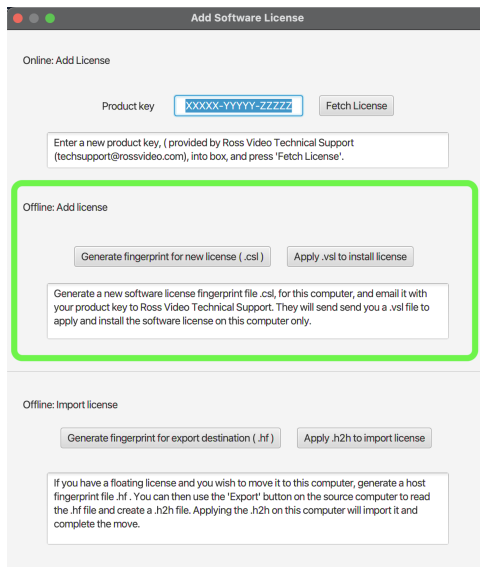

*Add Software License - Offline*

# Updating License

## Online

Updating a license updates any new sports you have purchased and ensures you have the latest expiry date. If you are using a floatable software license, its grace period will be reset so it will be valid for use.

Updating a USB license dongle or a software license are both done in the same way.

### To update a USB license dongle or software license:

1. Select the **Update** button, and after a few seconds the license details will be updated.

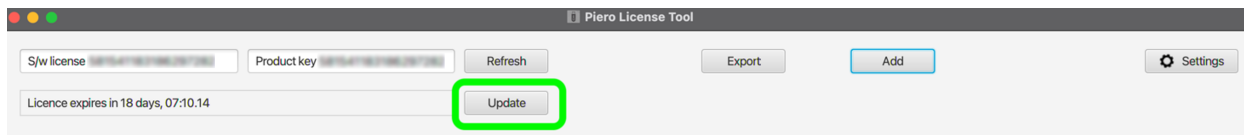

*Piero License Tool - Update*

2. Close the launcher, and then re-open it normally to run PIERO.

## Offline

If the user is offline, a license is updated in three stages:

1. Generate a license status **.c2v** (customer to vendor) file.
2. Email this license status **.c2v** file to [techsupport@rossvideo.com](mailto:techsupport@rossvideo.com) so they can generate a **.v2c** (vendor to customer) license update file for you.
3. Apply the **.v2c** license update.

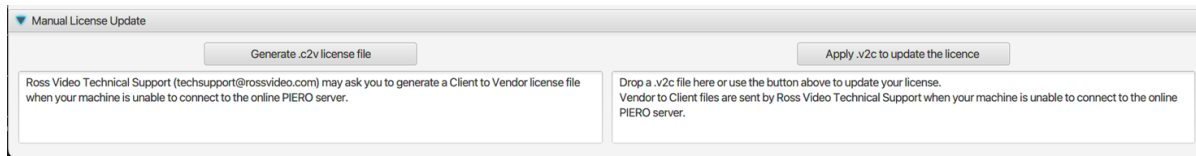

*Manual License Update - Generate a .c2v and Apply a .v2c to Update the License*

### To generate a license status **.c2v** file:

1. If you are using a USB key, ensure it is plugged into the computer running the PIERO application.
2. Select the **Manual License Update** section of the **Piero License Tool**.
3. Select **Generate .c2v license file**.
4. Select the **Generate license status.c2v file** button.  
After 10 seconds, a dialog will appear.
5. Select **Save** to create a **.c2v** file on the desktop.
6. Email this license status **.c2v** file to [techsupport@rossvideo.com](mailto:techsupport@rossvideo.com).

**To apply a licence update .v2c file:**

1. Save the license update **.v2c** file you have received to the desktop.
2. If you are using a USB dongle ensure it is plugged into the computer running the PIERO application.
3. Select **Apply .v2c to update the license** and navigate to the **.v2c** file, and then select **Open**.

"... *updated successfully*" will be displayed if the update was successful.

4. Close the launcher, and then re-open it normally to run PIERO.

Alternatively, you can drag and drop the **.v2c** file into the box containing the text *Drop a .v2c here...*

# Moving a software license between PIERO computers

A floatable software license can be moved between two PIERO computers, and is achieved using a host fingerprint file (.hf ) and a host to host (.h2h ), as follows:

1. On the destination PIERO computer where the license is being moved to, a host fingerprint file (.hf ) is created.
2. This .hf file is put on the PIERO computer where the software license is coming from (the source computer).
3. The source computer exports the license by reading the .hf file and creating a host to host (.h2h) file.
4. The .h2h file is then put on the destination computer where it is used to import the software license completing move.



**Warning:** if you delete your h2h file before it is applied on the new machine, you will destroy your license.

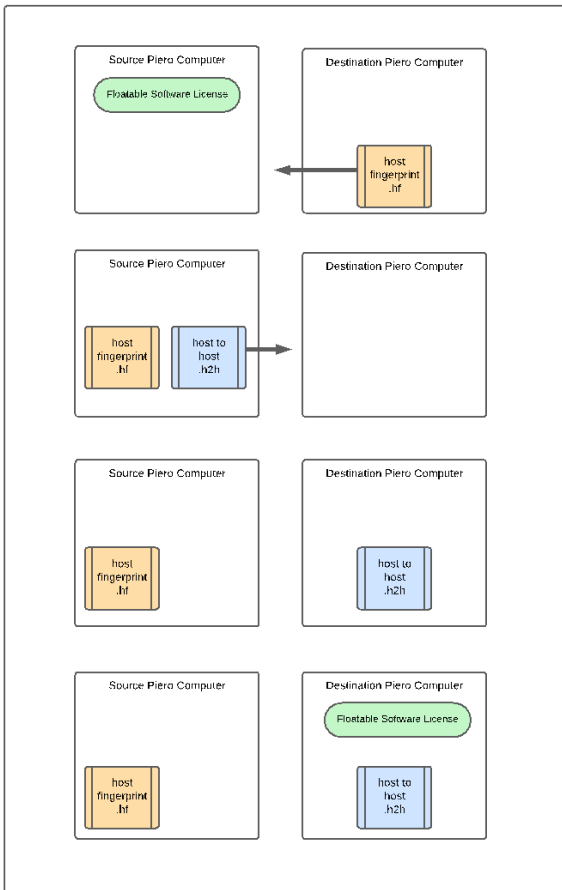

*Moving a software license between Piero computers - Workflow*

## To generate a Host Fingerprint File (.hf) on Destination PIERO:

- In the **PIERO License Tool**, select the **Add** button then select the **Generate fingerprint for export destination ( .hf )** button.

This will let you create a new **.hf** file which you can save to the desktop, making it ready to be taken to the source PIERO computer.

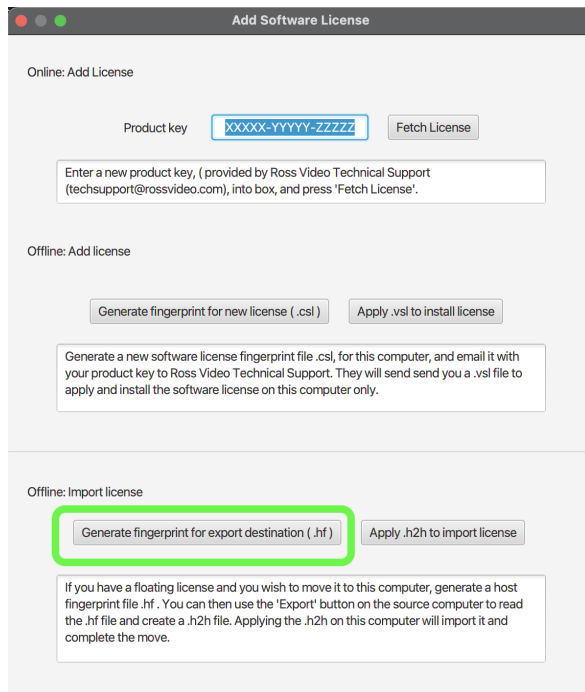

*Add Software License - Generate Fingerprint for Export Destination (.hf)*

## To transfer the Host Fingerprint File (.hf) to Source PIERO:

- Take the **.hf** file created on the destination PIERO computer and put it on the source PIERO computer.

## To Remove the License From the Source PIERO and Generate a Host to Host File (.h2h):

For this procedure, ideally only run the Launcher and the PIERO License Tool on the source PIERO computer.

1. If PIERO or any other Launcher modules (e.g. Data Visualization or Asset Manager etc ) are running, you must quit the modules. After they have all been quit, wait for 3 minutes to allow the 'sessions' to disappear.

You can check all sessions have gone by browsing the [http://127.0.0.1:1947/\\_int\\_/sessions.html](http://127.0.0.1:1947/_int_/sessions.html).

If there are any remaining sessions you may select the **Disconnect** button of each as shown below.

Sessions Host Name: [127.0.0.1](#)

ID	Key	Location	Product	Feature	Address	User	Machine	Login Time	Timeout	Actions
127.0.0.1	127.0.0.1	Local		0	Local	127.0.0.1	127.0.0.1	Tue Mar 5, 11:57:04	-	<a href="#">Disconnect</a>

*Sessions - Disconnect Button*

2. On the source computer select the Piero License Tool's **Export** button, which will open a **Export Software License to another PIERO** dialog shown below.

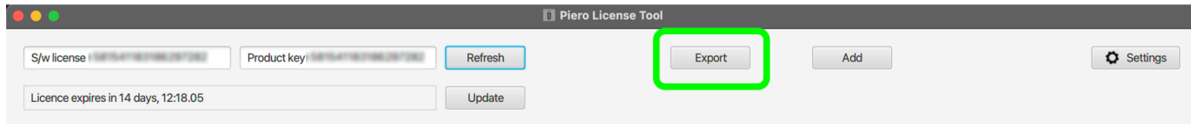

*PIERO License Tool - Export Button*

3. Select **Export**, as shown in the below dialog, which will open a **Destination PIERO** dialog, where you can select **Browse...** and select the host fingerprint file ( `.hf` ) you put on this computer.

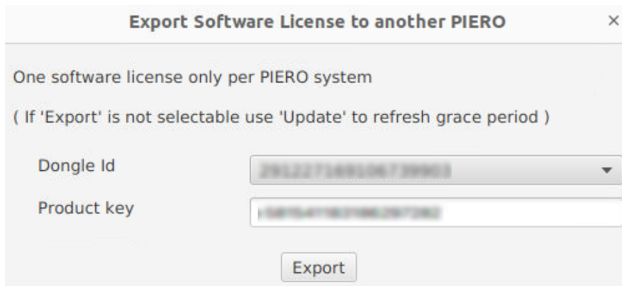

*Export Software License to Another PIERO Dialog*

★ **Tip:** If the **Export** button above is visible but not enabled it could mean the grace period has expired on your floatable license. The grace period can be updated by following the Updating instructions above.

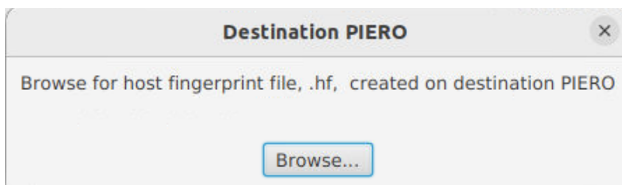

*Destination PIERO Dialog*

The software license will then be removed from this source Piero computer and a host to host ( `.h2h` ) will have been created.

4. The next step is to take this this **.h2h** file to the destination Piero computer.

**To Transfer the Host to Host File (.h2h) and apply it to the Source PIERO computer:**

1. Take the host to host **.h2h** file created from the source PIERO computer to the destination PIERO computer.
2. In the **PIERO License Tool**, select the **Add** button and then select **Apply .h2h to import license**, which will install the license on this computer.

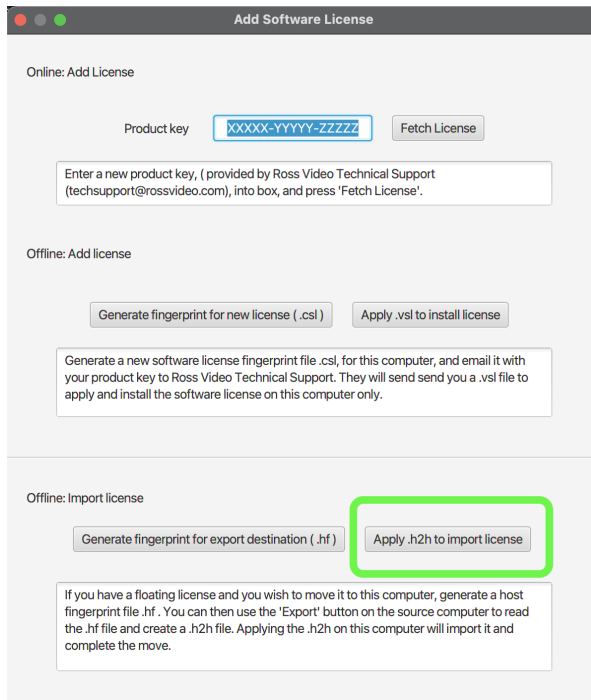

*PIERO License Tool - Apply .h2h to Import License Button*

3. Close the launcher, and then re-open it normally to run PIERO.

# Appendix A: Keyboard Shortcuts

## Cent OS 7 Shortcuts

Start menu/Access applications	Alt + F1
Run new application	Alt + F2
Show desktop	Ctrl + Alt + D
Lock desktop/Switch active user	Ctrl + Alt = L
Task manager	Ctrl + Esc

## Function Keys on a Mac

Press the FN key to use the function keys on a Mac.

<b>F1</b>	<b>F2</b>	<b>F3</b>	<b>F4</b>	<b>F5</b>	<b>F6</b>	<b>F7</b>	<b>F8</b>	<b>F9</b>	<b>F10</b>	<b>F11</b>	<b>F12</b>
Fast Rewind	Slow Rewind	-1 Second	-1 Frame	Play/ Pause	+1 Frame	+1 Second	Slow Forward	Fast Forward	Find	Reset Selected Effect on the Timeline	Delete Selected Effect on the Timeline

## General PIERO Shortcuts

Linux	Mac	Description
ESCAPE		In Touch mode, fade off effects and delete all
INSERT	NOT AVAILABLE	In multiscreen mode - toggle effect
HOME		Rewind clip
PAGE UP		Toggle on-air
DELETE		Delete effect
`	§	Toggle on-air
ENTER + ALT		Toggle full screen
Backspace + Ctrl	⌘ + Backspace	Delete effect
s + Ctrl	s + ⌘	Toggle calibration point
z + Ctrl	z + ⌘	Undo on timeline
s + Ctrl	s + ⌘	Copy on timeline
x + Ctrl	x + ⌘	Cut on timeline
v + Ctrl	v + ⌘	Paste on timeline
m + Ctrl	m + ⌘	Set cue point
< + Ctrl	< + ⌘	Cue previous
> + Ctrl	> + ⌘	Cue next
-	-	Magnifier control zoom out
= or +	= or +	Magnifier control zoom in
- + Ctrl	- + ⌘	Magnifier control toggle off
Spacebar		Play/stop (Disabled in Touch mode)

## IN/OUT Point Shortcuts

On the number pad, pressing the forward slash key (/) will set the **IN** point of the selected effect and pressing the asterisk key (\*) will set the **OUT** point of the selected effect (just like the clock icon).

# Appendix B: Audio Options

Audio is enabled via the Launcher at start-up and is configured in the project.

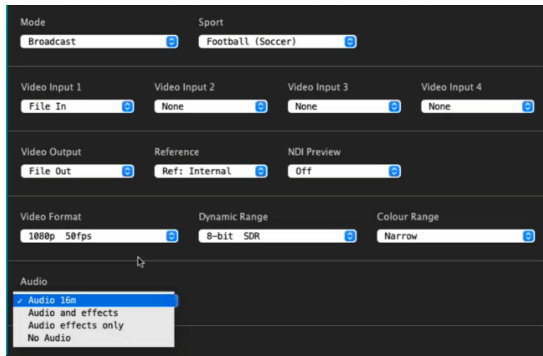

*Broadcast Launcher - Audio Section*

## To add audio to a project:

1. From the **Launcher**, from the **Audio** drop-down, select the audio option you want to use, and launch PIERO.
2. In the **Effects** panel, select the  **Sound Effect** button.  
The **Sound effect** appears in the timeline.
3. Position the **Sound effect** where you want it along the timeline and adjust its duration.
4. In the **Sound effect's** parameter sheet, select the File folder icon.  
The file explorer opens.
5. Navigate to the location of the sound file you want to use and select **Open Sound**.  
The file explorer closes and the sound is added to the **Sound effect**.

# Appendix C: PIERO User Interface Theme

Two distinct User Interface themes are available: Light and Dark, offering flexibility to customize the visual experience. This feature is accessible across all PIERO interfaces. This section provides guidance on selecting and applying a preferred PIERO User Interface theme to enhance usability and align with visual preferences.

## To select a UI theme:

1. In the **Settings** panel, go to the **General** tab.

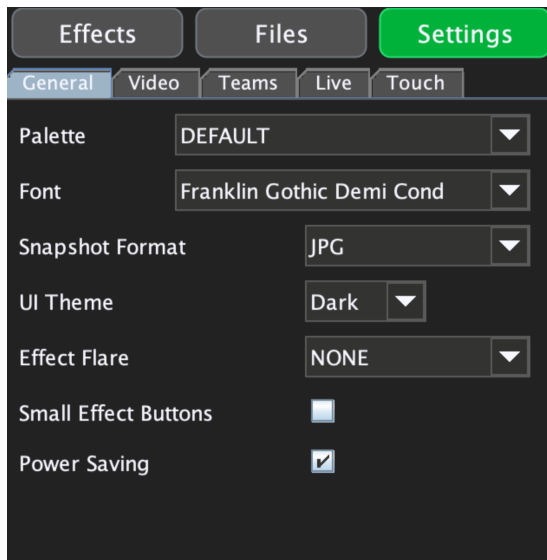

*Select a UI Theme*

2. From the **UI Theme** drop-down, select either **Light** or **Dark**.
3. Restart PIERO to apply the new theme.

# Appendix D: Asset Descriptions

This appendix provides descriptions for the assets listed below, serving as a quick reference for their specifications.

★ **Note:** each specification measurement is in pixels.

[Area Textures](#)  295

[Arrow Textures](#)  296

[Caption](#)  297

[Circle Textures](#)  298

[Colour Palette](#)  299

[Down & Distance](#)  300

[End Zone Logos](#)  301

[Field Goal Line Font](#)  303

[Laser Eye Texture](#)  304

[2D Line Texture](#)  305

[Line-up Cards](#)  306

[Logos](#)  307

[Markers](#)  308

[Magnifiers](#)  309

[Movies](#)  310

[Red Zone](#)  311

[Safe Areas](#)  312

[Spotlight Base](#)  313

[Stadium Adverts](#)  314

[Stadium Grass Texture](#)  315

[Stadium Pitch Logos](#)  316

[Tactical Board](#)  317

[Text Background](#)  318

[Text Background Wings](#)  319

[Title Text](#)  320

## Area Textures

The specifications for the Area Texture are outlined in the table below.

Specifications:	Example:
<ul style="list-style-type: none"><li>• Maximum Resolution: 2160 x 2160 px</li><li>• Recommended Resolution: 1080 x 1080 px</li><li>• TGA Sequence Max Resolution: 512 x 512 px</li><li>• TGA Sequence Recommended Resolution: 256 x 256 px</li><li>• Supported File Types: PNG, TGA</li><li>• Supports Transparency: Yes</li><li>• Bit Depth: 8 bit</li></ul>	<p data-bbox="899 380 1166 474">PNG Recommended: 2160x2160 PNG Max: 1080x1080 TGA Recommended: 256x265 TGA Max: 512x512</p>  <p data-bbox="886 684 964 705">Example:</p> 

## Arrow Textures

The specifications for the Arrow Textures are outlined in the table below.

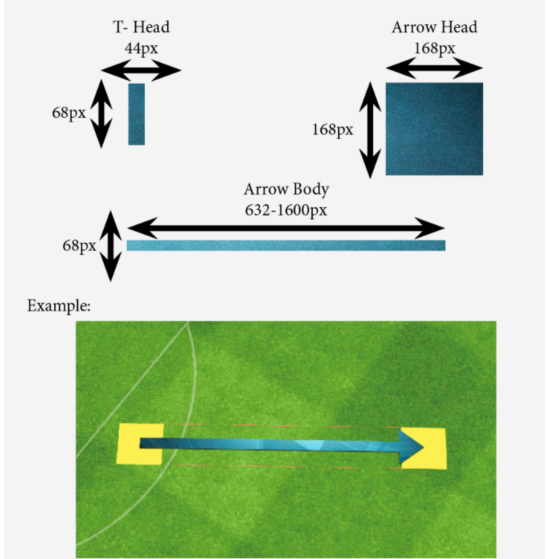
Specifications:	Example:
<ul style="list-style-type: none"><li>• Maximum Resolution: Body: 1600 x 68 px; Head: 168 x 168 px; T Head: 44 x 68 px</li><li>• Recommended Resolution: Body: 632 x 68 px; Head: 168 x 168 px; T Head: 44 x 68 px</li><li>• TGA Sequence Max Resolution: 512 x 256 px</li><li>• TGA Sequence Recommended Resolution: 256 x 128 px</li><li>• Supported File Types: PNG, TGA</li><li>• Supports Transparency: Yes</li><li>• Bit Depth: 8-bit</li></ul> <p>★ <b>Note:</b> The Head and T Head textures use a fixed resolution. The resolution of the Body texture can vary in length (width) and is subject to stretching by the PIERO Arrow renderer. Each image that makes up an arrow must have the same file name.</p>	 <p>The diagram illustrates the three components of an arrow texture. The T-Head is a small vertical rectangle with a width of 44px and a height of 68px. The Arrow Head is a square with a width of 168px and a height of 168px. The Arrow Body is a long horizontal rectangle with a height of 68px and a width that can range from 632px to 1600px. Below the diagram, an example shows a blue arrow with yellow heads on a green field background.</p>

## Caption

The specifications for the Caption are outlined in the table below.

Specifications:	Example:
<ul style="list-style-type: none"><li>• Maximum Resolution: 312 x 280 px</li><li>• Recommended Resolution: 156 x 140 px</li><li>• Supported File Types: PNG, JPEG</li><li>• Supports Transparency: Yes</li><li>• Bit Depth: 8 bit</li></ul> <p>★ Rectangular captions are also supported and have a recommended resolution of 428x80 px</p>	

## Circle Textures

The specifications for the Circle Textures are outlined in the table below.

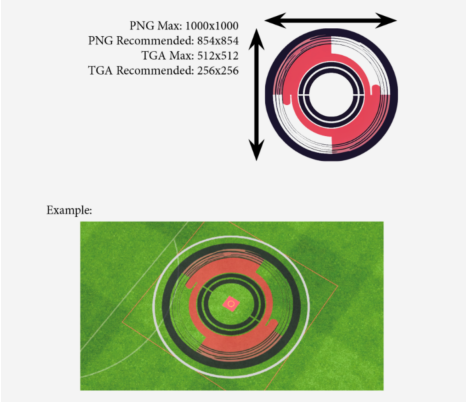
<b>Specifications:</b>	<b>Example:</b>
<ul style="list-style-type: none"><li>• Maximum Resolution: 1000 x 1000 px</li><li>• Recommended Resolution: 854 x 854 px</li><li>• TGA Sequence Max Resolution: 512 x 512 px</li><li>• TGA Sequence Recommended Resolution: 256 x 256 px</li><li>• Supported File Types: PNG, TGA</li><li>• Supports Transparency: Yes</li><li>• Bit Depth: 8 bit</li></ul>	 <p>PNG Max: 1000x1000 PNG Recommended: 854x854 TGA Max: 512x512 TGA Recommended: 256x256</p> <p>Example:</p> <p>The diagram illustrates a circle texture with a red and white pattern. It includes a horizontal double-headed arrow above the circle and a vertical double-headed arrow to its left, indicating its dimensions. Below the circle, the word "Example:" is followed by a small image showing the circle texture applied to a green field with a red diamond in the center, demonstrating its use in a game environment.</p>

# Colour Palette

The specifications for the Colour Palette are outlined in the table below.

Specifications:		Values:				
<ul style="list-style-type: none"> <li>• Colour Palettes are CSV files which define a list of colours by RGBA values (values are from 0 to 255).</li> <li>• Each line should start with a colour name followed by Red, Green, Blue then Alpha (transparency) values.</li> <li>• It is possible to alter their values but not their name.</li> <li>• Add as many colours as you need per palette.</li> </ul> <p>★ <b>Important:</b> The colours White, Red, Black, Blue (light), Blue, Grey, Orange, Yellow (light), Yellow and Green must be present for PIERO effects to work.</p>						
	A	B	C	D	E	
1	White	250	250	250	255	
2	Grey	153	153	153	255	
3	Black	25	25	25	255	
4	Red	204	26	26	255	
5	Bordeaux	105	29	18	255	
6	Burgundy	206	0	97	255	
7	Violet	92	54	151	255	
8	Purple	178	26	244	255	
9	Green	26	166	26	255	
10	Blue (light)	0	153	255	255	
11	Blue	0	56	255	255	
12	Yellow (light)	245	245	102	255	
13	Yellow	254	193	13	255	
14	Orange	255	128	0	255	
15	Brown	74	50	20	255	
16	Semi Transp Ref	198	168	118	150	
17	Argentina Blue	117	178	249	255	
18	Argentina Dark Blue	22	30	114	255	
19	Argentina Purple	86	78	192	255	
20	Australia Gold	245	188	65	255	
21	Australia Green	73	164	158	255	
22	Belgium Cyan	226	249	247	255	
23	Belgium Red	231	49	35	255	
24	Belgium Yellow	249	213	72	255	

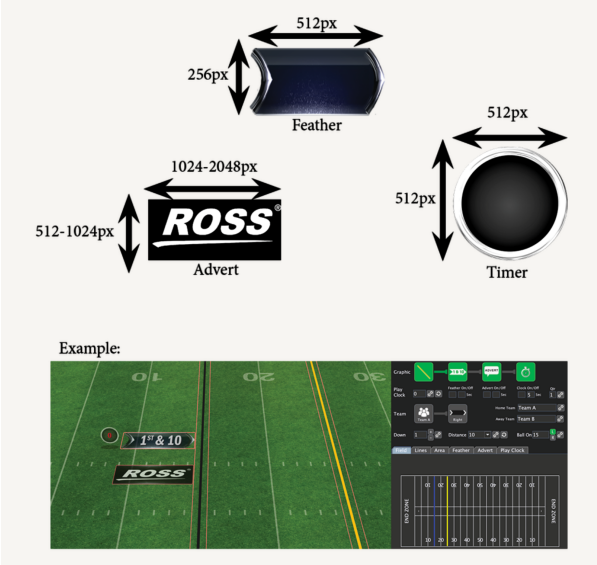

# Down & Distance

The specifications for the Down and Distance are outlined in the table below.

Specifications:	Example:
<ul style="list-style-type: none"> <li>• Maximum Resolution: Advert: 2048 x 1024 px; Feathers: 512 x 256 px; Timer Background: 512 x 512 px</li> <li>• Recommended Resolution: Advert: 1024 x 512 px; Feathers: 512 x 256 px; Timer Background: 512 x 512 px</li> <li>• TGA Sequence Max Resolution: 512 x 512 px</li> <li>• TGA Sequence Recommended Resolution: 256 x 256 px</li> <li>• Supported File Types Single Assets: PNG, TGA</li> <li>• Supported File Types Sequences: TGA</li> <li>• Supports Transparency: Yes</li> <li>• Bit Depth: 8 bit</li> <li>• When importing TGA sequences for feathers and adverts they can only be a single layer.</li> </ul>	 <p>The diagram illustrates the dimensions for three types of assets used in the game:         <ul style="list-style-type: none"> <li><b>Feather:</b> A curved, blue-tinted asset with a width of 512px and a height of 256px.</li> <li><b>Advert:</b> A rectangular asset featuring the 'ROSS' logo, with a width of 1024-2048px and a height of 512-1024px.</li> <li><b>Timer:</b> A circular asset with a width and height of 512px each.</li> </ul>         Below the diagram, an 'Example' screenshot shows a football field with a 'ROSS' advert overlaid on the grass and a '1st &amp; 10' down marker. A game interface is visible on the right side of the screenshot.       </p>

# End Zone Logos

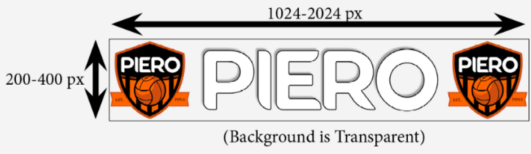
The specifications for the End Zone Logos are outlined in the table below.

Specifications:	Example:
<ul style="list-style-type: none"><li>• Maximum Resolution: 1024 x 200 px</li><li>• Recommended Resolution: 2048 x 400 px</li><li>• Supported File Types: PNG</li><li>• Supports Transparency: Yes</li><li>• Bit Depth: 8 bit</li></ul>	 <p>The diagram shows the logo with a horizontal double-headed arrow above it labeled "1024-2024 px" and a vertical double-headed arrow to its left labeled "200-400 px". The logo consists of two circular emblems on the sides, each containing a soccer ball and the word "PIERO", and the word "PIERO" in large, outlined letters in the center. Below the logo, it says "(Background is Transparent)".</p> <p>Example:</p>  <p>The example image shows a football field with the "PIERO" logo and emblems painted on the end zone. A yellow goalpost is visible in the background.</p>

## Field Goal Line

The specifications for the Field Goal Line are outlined in the table below.

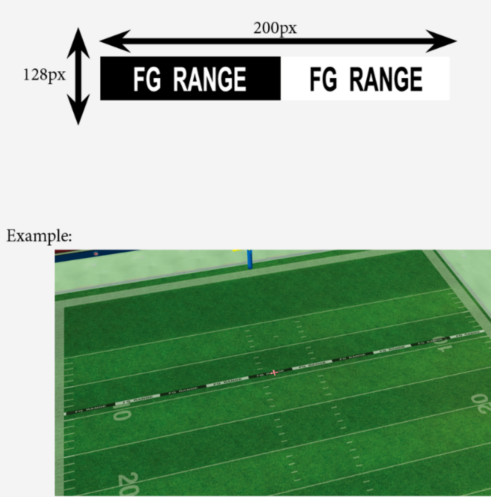
Specifications:	Example:
<ul style="list-style-type: none"><li>• Maximum Resolution: Pitch Width x 128 px</li><li>• Recommended Resolution: 200 x 128 px</li><li>• Supported File Types: PNG</li><li>• Supports Transparency: Yes</li><li>• Bit Depth: 8 bit</li><li>• The width can vary. The texture will be automatically wrapped as many time as necessary to fill the pitch width.</li></ul>	 <p>The diagram shows a horizontal texture labeled 'FG RANGE' on a black background. A vertical double-headed arrow on the left indicates a height of 128px. A horizontal double-headed arrow above the texture indicates a width of 200px. Below the diagram, the word 'Example:' is followed by a photograph of a soccer field with a field goal line texture applied to the grass.</p>

# Font

The specifications for the Font are outlined in the table below.

Specifications:	Example:
<ul style="list-style-type: none"><li>• Maximum Resolution: N/A</li><li>• Recommended Resolution: Body: N/A</li><li>• Supported File Types: TTF, OTF</li><li>• Supports Transparency: N/A</li><li>• Bit Depth: 8 bit</li><li>• Accents, Arabic, Japanese and Chinese fonts are supported.</li></ul>	 <p>The example shows the font's character set: uppercase letters A through Z, lowercase letters a through z, and digits 0 through 9. The characters are rendered in a bold, blocky, sans-serif style with a slightly distressed or textured appearance.</p>

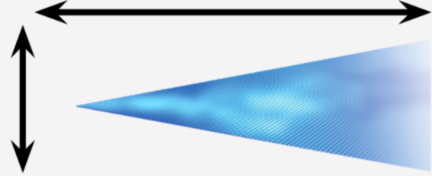
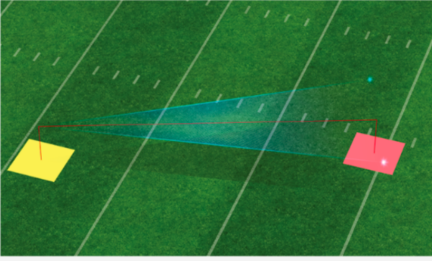

# Laser Eye Texture

The specifications for the Laser Eye Textures are outlined in the table below.

Specifications:	Example:
<ul style="list-style-type: none"><li>• Maximum Resolution: Body: 1218 x 452 px</li><li>• Recommended Resolution: Body: 1218 x 452 px</li><li>• TGA Sequence Max Resolution: 512 x 512 px</li><li>• TGA Sequence Recommended Resolution: 256 x 256 px</li><li>• Supported File Types: PNG, TGA</li><li>• Supports Transparency: Yes</li><li>• Bit Depth: 8 Bit</li></ul> <p>★ <b>Note:</b> The laser eye uses a fixed texture size. For PNGs, square or wide image ratios may be used. PIERO will distort the image as needed, while TGA image resolutions remain fixed.</p>	<p>PNG Max and Recommended: 1218x452 TGA Max: 512x512</p>  <p>Example:</p> 

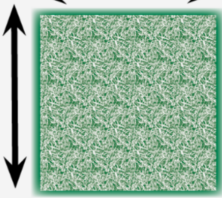

## 2D Line Texture

The specifications for the 2D Line Texture are outlined in the table below.

Specifications:	Example:
<ul style="list-style-type: none"><li>• Maximum Resolution: 512 x 512 px</li><li>• Recommended Resolution: 128 x any custom width under 512 px</li><li>• Supported File Types: PNG, TGA</li><li>• Supports Transparency: Yes</li><li>• Bit Depth: 8 bit</li></ul> <p>These assets are used in the chalk border (such as in area effect borders) and the Crowned Line in Down and Distance. Images should be white to allow recoloring in PIERO. Textures should be designed to tessellate for seamless looping.</p>	<p>PNG Recommended: 128x128 PNG Max: 512x512</p>  <p>Green Background added to show white asset.</p> <p>Example (horizontal chalk lines):</p> 

## Line-up Cards

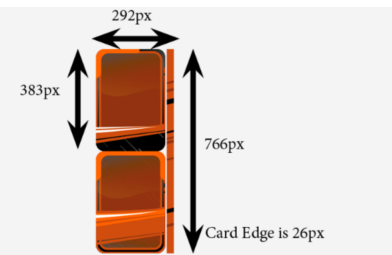
The specifications for the Line-up Cards are outlined in the table below.

Specifications:	Example:
<ul style="list-style-type: none"><li>• Maximum Resolution: 292 x 766 px</li><li>• Recommended Resolution: Body: 292 x 766 px</li><li>• Supported File Types: PNG</li><li>• Supports Transparency: Yes</li><li>• Bit Depth: 8 bit</li></ul> <p>★ <b>Note:</b> the resolution for these textured are fixed.</p>	 <p>Example:</p> 

# Logos

The specifications for the Logos are outlined in the table below.

Specifications:	Example:
<ul style="list-style-type: none"><li>• Maximum Resolution: 2160 x 2160 px</li><li>• Recommended Resolution: 1080 x 1080 px</li><li>• Supported File Types: PNG, TGA, JPG</li><li>• Supports Transparency: Yes</li><li>• Bit Depth: 8 bit</li></ul>	 <p>The example section contains two images. The top image shows the 'PIERO' logo, which is a shield-shaped emblem with a soccer ball in the center. The word 'PIERO' is written in a bold, white, sans-serif font across the top of the shield. Below the shield is a red banner with the text 'Est. 1904' on the left and '1904' on the right. Two double-headed arrows indicate the dimensions: a horizontal arrow at the top labeled '1080-2160px' and a vertical arrow on the left labeled '1080-2160px'. Below this image is the word 'Example:' followed by a photograph of a soccer field. Two versions of the 'PIERO' logo are overlaid on the field: one is smaller and positioned near the center circle, while the other is larger and positioned near the right sideline.</p>

# Markers

The specifications for the Markers are outlined in the table below.

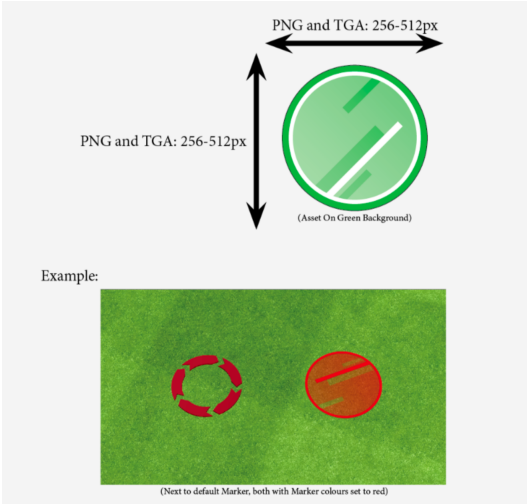
Specifications:	Example:
<ul style="list-style-type: none"><li>• Maximum Resolution: 512 x 512 px</li><li>• Recommended Resolution: 256 x 256 px</li><li>• TGA Sequence Max Resolution: 512 x 512 px</li><li>• TGA Sequence Recommended Resolution: 256 x 256 px</li><li>• Supported File Types: PNG, TGA</li><li>• Supports Transparency: Yes</li><li>• Bit Depth: 8 bit</li></ul>	 <p>The diagram illustrates the specifications for a marker. At the top, a horizontal double-headed arrow is labeled "PNG and TGA: 256-512px". To its left, a vertical double-headed arrow is also labeled "PNG and TGA: 256-512px". In the center is a green circular marker with a white diagonal line and a white arrow. Below the marker is the text "(Asset On Green Background)". Below this is the word "Example:" followed by a rectangular image of a green field with two red circular markers. The first marker is a red circle with a white arrow, and the second is a red circle with a white diagonal line. Below the field image is the text "(Next to default Marker, both with Marker colours set to red)".</p>

# Magnifier

The specifications for the Magnifier are outlined in the table below.

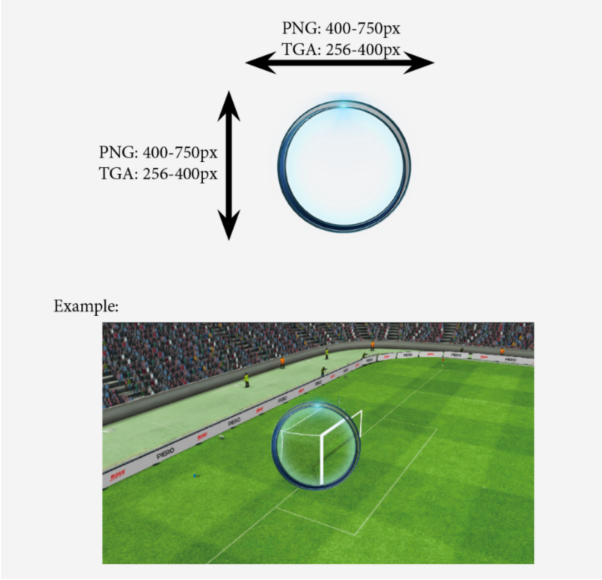
Specifications:	Example:
<ul style="list-style-type: none"><li>• Maximum Resolution: 750 x 750 px</li><li>• Recommended Resolution: 400 x 400 px</li><li>• TGA Sequence Max Resolution: 512 x 512 px</li><li>• TGA Sequence Recommended Resolution: 256 x 256 px</li><li>• Supported File Types: TGA</li><li>• Supports Transparency: Yes</li><li>• Bit Depth: 8 bit</li></ul>	 <p>The diagram shows a magnifier, which is a circular lens with a blue glow. Above it, a horizontal double-headed arrow indicates a resolution range: PNG: 400-750px and TGA: 256-400px. To the left of the magnifier, a vertical double-headed arrow indicates another resolution range: PNG: 400-750px and TGA: 256-400px. Below the magnifier, the word "Example:" is written above a screenshot of a soccer field. In the screenshot, the magnifier is positioned over the goal, showing a magnified view of the goal area.</p>

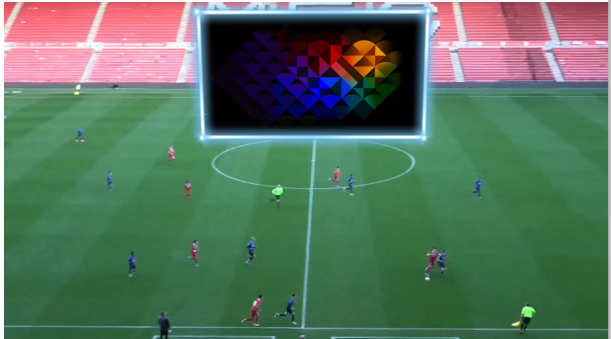

# Movies

The specifications for the Movies asset are outlined in the table below.

Specifications:	Example:
<ul style="list-style-type: none"><li>• Maximum Resolution: N/A</li><li>• Recommended Resolution: N/A</li><li>• Supported File Types: TGA</li><li>• TGA Sequence Max Resolution: 512 x 512 px</li><li>• TGA Sequence Recommended Resolution: 256 x 256 px</li><li>• Supports Transparency: Yes</li><li>• Bit Depth: 8 bit</li></ul> <p>For Movies, the resolution of images depends entirely on the surface to which the texture is rendered, making it difficult to recommend a specific size.</p>	 An image of a soccer field with a colorful, abstract texture overlaid on the center circle. The texture consists of a grid of small, multi-colored squares (red, blue, yellow, green) arranged in a circular pattern. The texture is rendered on a flat surface, demonstrating how the resolution of the image depends on the surface it is applied to.



# Red Zone

The specifications for the Red Zone are outlined in the table below.

Specifications:	Example:
<ul style="list-style-type: none"><li>• Maximum Resolution: 3000 x 1698 px</li><li>• Recommended Resolution: 2048 x 1160 px</li><li>• Supported File Types: PNG, JPG, TGA</li><li>• Supports Transparency: Yes</li><li>• Bit Depth: 8 bit</li></ul>	<p data-bbox="873 373 1136 415">PNG Max: 2048X1160 PNG Recommended: 3000X1698</p>  <p data-bbox="873 657 954 678">Example:</p> 

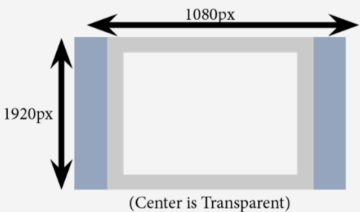

# Safe Area

The specifications for the Safe Area are outlined in the table below.

Specifications:	Example:
<ul style="list-style-type: none"><li>• Maximum Resolution: 1920 x 1080 px</li><li>• Recommended Resolution: 1920 x 1080 px</li><li>• Supported File Types: PNG, TGA</li><li>• Supports Transparency: Yes</li><li>• Bit Depth: 8 bit</li></ul> <p>The texture is toggled on and off by the operator at runtime and is displayed in 2D, full-screen, over the incoming video. It is recommended to mark areas reserved for the clock, logo, and lower thirds to assist the PIERO operator.</p>	 <p>(Center is Transparent)</p> <p>Example:</p> 

# Spotlight Base

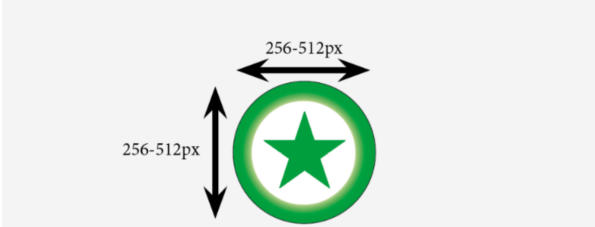
The specifications for the Spotlight Base are outlined in the table below.

Specifications:	Example:
<ul style="list-style-type: none"><li>• Maximum Resolution: 512 x 512 px</li><li>• Recommended Resolution: 256 x 256 px (512 x 512 px is also acceptable)</li><li>• Supported File Types: PNG</li><li>• Supports Transparency: Yes</li><li>• Bit Depth: 8 bit</li></ul>	 <p>(Center is Transparent, asset on green background for demonstration)</p> <p>Example:</p> 



# Stadium Adverts

The specifications for the Stadium Adverts are outlined in the table below.

Specifications:	Example:
<ul style="list-style-type: none"> <li>• Maximum Resolution: 512 x 128 px</li> <li>• Recommended Resolution: 512 x 128 px</li> <li>• Supported File Types: PNG</li> <li>• Supports Transparency: No</li> <li>• Bit Depth: 8 bit</li> </ul> <p>Adverts must be provided in pairs, named advert1.png and advert2.png, and stored in a dedicated folder with no other files. The folder name will appear in the user interface to facilitate advert selection.</p> <p>Example: A folder named "Ross Video" containing advert1.png and advert2.png.</p>	<div data-bbox="867 352 1458 567"> <p>512px</p> <p>128px</p> <p><b>ROSS</b></p> <p>(Assets in advert folder will alternate in the Stadium)</p> </div> <p>Example:</p> <div data-bbox="940 665 1406 930"> </div>

# Stadium Grass or Floor

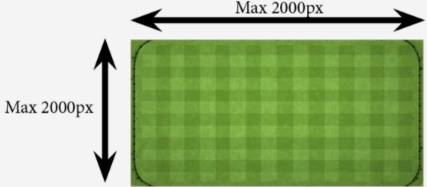
The specifications for the Stadium Grass or Floor are outlined in the table below.

Specifications:	Example:
<ul style="list-style-type: none"><li>• Maximum Resolution: 2000 x 2000 px</li><li>• Recommended Resolution: Soccer-Football: 1024 x 512 px, Basketball: 1920 x 1024 px</li><li>• Supported File Types: PNG</li><li>• Supports Transparency: No</li><li>• Bit Depth: 8 bit</li></ul> <p>In some stadiums, the grass texture may be bound differently and may require transparent padding to align with the pitch edges.</p>	 <p>(Recommended resolution varies between sports)</p> <p>Example:</p> 

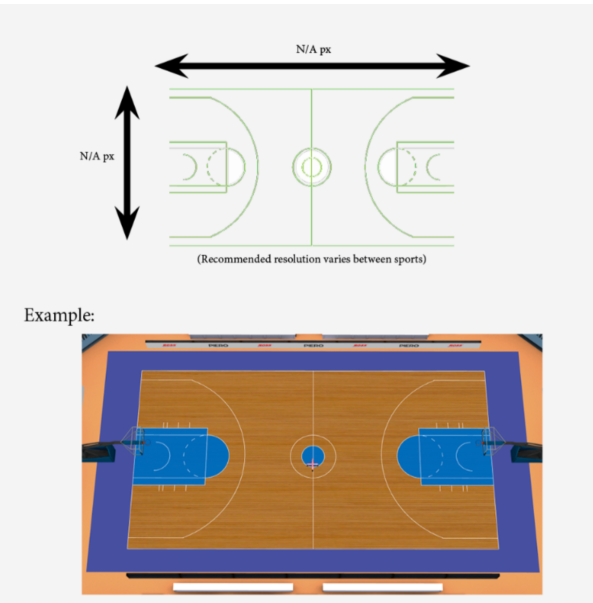

# Stadium Pitch Logos

The specifications for the Stadium Pitch Logos are outlined in the table below.

Specifications:	Example:
<ul style="list-style-type: none"> <li>• Maximum Resolution: N/A</li> <li>• Recommended Resolution: N/A</li> <li>• Supported File Types: PNG</li> <li>• Supports Transparency: Yes</li> <li>• Bit Depth: 8 bit</li> </ul> <p>The PNG textures must match the stadium's dimension aspect ratio. The pitch lines are provided for guidance only and should not be included in the textures.</p>	 <p>The diagram shows a top-down view of a stadium pitch. A horizontal double-headed arrow at the top is labeled 'N/A px'. A vertical double-headed arrow on the left is labeled 'N/A px'. Below the pitch lines, the text '(Recommended resolution varies between sports)' is present. Below this diagram, the word 'Example:' is followed by a 3D-rendered image of a stadium pitch with a blue field and orange seating.</p>

# Tactical Board Texture

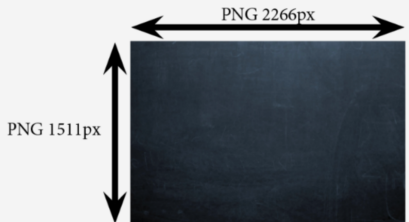
The specifications for the Tactical Board Textures are outlined in the table below.

Specifications:	Example:
<ul style="list-style-type: none"><li>• Maximum Resolution: 2266 × 1511 px</li><li>• Recommended Resolution: 2266 × 1511 px</li><li>• Supported File Types: PNG, JPG</li><li>• Supports Transparency: Yes</li><li>• Bit Depth: 8 bit</li></ul>	 <p data-bbox="885 651 958 672">Example:</p>  <p data-bbox="982 882 1339 903">(Tactical Board asset is used for the background)</p>

# Text Background

The specifications for the Text Background are outlined in the table below.

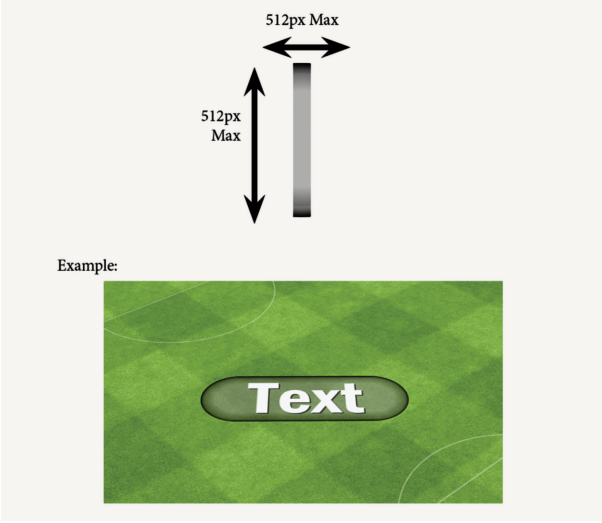
Specifications:	Example:
<ul style="list-style-type: none"><li>• Maximum Resolution: 512 x 512 px</li><li>• Recommended Resolution: Body: 256 x 256 px</li><li>• TGA Sequence Max Resolution: 512 x 512 px</li><li>• TGA Sequence Recommended Resolution: 256 x 256 px</li><li>• Supported File Types: PNG, TGA</li><li>• Supports Transparency: Yes</li><li>• Bit Depth: 8 bit</li></ul>	 <p>The diagram illustrates the dimensions for a text background. It shows a vertical bar with a double-headed arrow indicating a height of 512px Max and another double-headed arrow indicating a width of 512px Max. Below this, the word 'Example:' is followed by a rectangular image of a green field with a white oval containing the word 'Text' in white.</p>

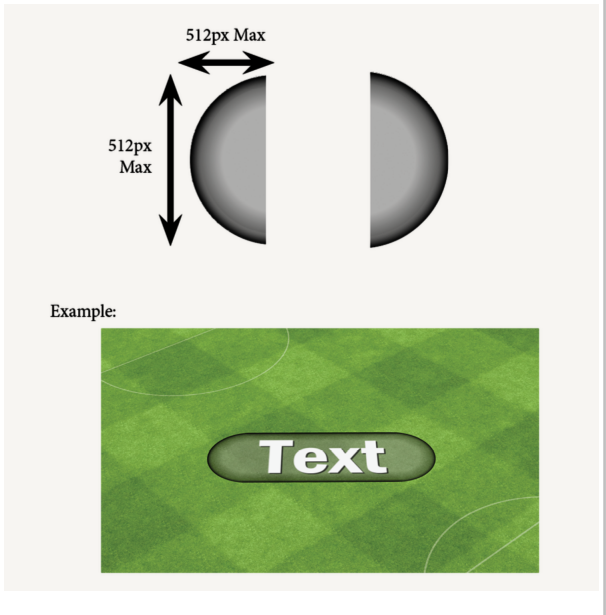

# Text Background Wings

The specifications for the Text Background Wings are outlined in the table below.

Specifications:	Example:
<ul style="list-style-type: none"><li>• Maximum Resolution: 512 x 512 px</li><li>• Recommended Resolution: Body: 256 x 256 px</li><li>• Image ratios are not fixed</li><li>• Supported File Types: PNG</li><li>• Supports Transparency: Yes</li><li>• Bit Depth: 8 bit</li><li>• The texture names must end with <code>_left.png</code> and <code>_right.png</code> (case sensitive).</li></ul>	 <p>The diagram illustrates the 'Text Background Wings' concept. It shows two semi-circular wings, one on the left and one on the right, with a maximum width of 512px and a maximum height of 512px. Below this, an example shows a green field with a 'Text' button in the center.</p>

# Title Text

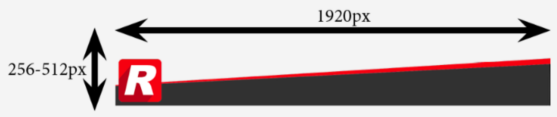
The specifications for the Title Text are outlined in the table below.

Specifications:	Example:
<ul style="list-style-type: none"><li>• Maximum Resolution: 1920 x 512 px</li><li>• Recommended Resolution: Body: 1920 x 256 px</li><li>• Supported File Types: PNG</li><li>• Supports Transparency: Yes</li><li>• Bit Depth: 8 bit</li></ul>	 <p>Example:</p> 

# Appendix E: High Dynamic Range Support

This document provides information on the current status of PIERO's support for High Dynamic Range (HDR).

## Video

PIERO 19.2 or later	HLG and SLOG-3 (Sony S-Log) supported with full, narrow and extended color ranges.
---------------------	--

## Files

HDR Video Files - Linux Version	HLG using xavcIntra100 and xavc4kIntra in an mxf container or prores422HQ in mov (recommended). HLG supported with full, narrow and extended color ranges.
HDR Video Files - Mac Version	May have limitation depending on what PIERO can decode and the specific PIERO license. XAVC Intra QFHD class 300 for UHD and XAVC Intra 100 for HD recommended.

## Notes

- PQ not supported.
- PIERO does not transcode video. HDR video input to PIERO will maintain full quality output.
- Graphics added by PIERO are within the SDR color space, regardless if the video is HDR or SDR.
- Graphics uploaded to the Asset Manager must be 8bit SDR.
- ST2110 video will support HDR, like SDI video.
- NDI Video does not support HDR, therefore NDI outputs and Touch outputs can only be SDR.

# Appendix F: Third Party Licenses

This product may use one or more software components subject to the following licenses.

As required by the GNU General Public License, and the Lesser GNU Public License (LGPL), source code can be obtained from Ross Video for at least 3 years. Contact [Ross Video Technical Support](#) for more information.

Software licenses used are described in the table below:

NAME	VERSION	LICENSE
<b>Apache Commons</b>		
Commons Lang	3.2.1	<a href="#">Apache License 2.0</a> <sup>[332]</sup>
An O(n) Time Algorithm for Finding an Ear by Hossam ElGindy, Hazel Everett, and Godfried T. Toussaint	Unspecified	<a href="#">Apache License 2.0</a> <sup>[332]</sup>
Convex Hull by Alexander Hristov	Unspecified	<a href="#">Apache License 2.0</a> <sup>[332]</sup>
<b>CAL3D</b>	0.11.0	<a href="#">GNU Lesser Public License 3.0</a> <sup>[349]</sup>
<b>ControlsFX</b>	8.40.12, 11.1.1	<a href="#">3 Clause BSD License</a> <sup>[330]</sup>
<b>Eclipse Enterprise for Java (EE4J)</b>		
Eclipse Tyrus	2.1.5	<a href="#">Eclipse Public License 2.0</a> <sup>[338]</sup>
Eclipse Implementation of JAXB	4.0.4	<a href="#">Eclipse Distribution License 1.0</a> <sup>[342]</sup>
iStack Common Utility Code	4.1.2	<a href="#">Eclipse Distribution License 1.0</a> <sup>[342]</sup>
<b>Font-Awesome</b>	Unspecified	<a href="#">SIL OFL 1.1 License</a> <sup>[366]</sup>
<b>Fontconfig</b>	2.5.0	<a href="#">MIT License Modern Variant</a> <sup>[355]</sup>
<b>Freelut</b>	3.4.0	<a href="#">MIT License Altered</a> <sup>[356]</sup>
<b>Jackson (com.fasterxml.jackson)</b>		
core	2.16.1	<a href="#">Apache License 2.0</a> <sup>[332]</sup>
jackson-databind	2.16.1	
jackson-annotations	2.16.1	
<b>Jakarta EE</b>		
Jakarta Websocket	2.1.1	<a href="#">Eclipse Public License 2.0</a> <sup>[338]</sup>
Jakarta XML Binding	4.0.1	<a href="#">Eclipse Distribution License 1.0</a> <sup>[342]</sup>
Jakarta Activation	2.1.2	<a href="#">Eclipse Distribution License 1.0</a> <sup>[342]</sup>
<b>Java Community Process</b>		
Java Specification Request 80, javax.usb	1.0.2	<a href="#">Common Public License</a> <sup>[335]</sup>
<b>Java Native Access (JNA)</b>		
jna	5.14.0	<a href="#">Apache License 2.0</a> <sup>[332]</sup>
<b>jdom.org</b>		
jdom	2.0.6	<a href="#">Modified Apache License 1.1</a> <sup>[359]</sup>
<b>JogAmp</b>		

NAME	VERSION	LICENSE
JOGL	2.3.2, 2.4.0	<a href="#">2 Clause BSD License Altered</a> <sup>[324]</sup>
<b>JSON Java</b>		
JSON, org.json	20240205.0.0	Public Domain
<b>JTouchBar</b>	1.0.0	<a href="#">MIT License</a> <sup>[357]</sup>
<b>libjpeg-turbo</b>	1.5.1	<a href="#">3 Clause BSD License</a> <sup>[331]</sup> and <a href="#">IJG License</a> <sup>[352]</sup>
<b>NDI</b>		
NDI SDK	V4.6, 5.6	<a href="#">SDK</a> <sup>[360]</sup>
<b>Nurbs++</b>		
Nurbs++ library	3.0.11	<a href="#">GNU Library Public License</a> <sup>[349]</sup>
<b>OpenGL</b>		
OpenGL header files and libraries Linux	2.1	<a href="#">Mesa 3D License</a> <sup>[354]</sup>
OpenGL header files and libraries Mac	2.1	<a href="#">SGI Free Software License B 2.0</a> <sup>[369]</sup>
<b>Open MP</b>		
Open MP Ubuntu	v5.0	<a href="#">GNU Public License</a> <sup>[349]</sup>
Open MP Mac	v5.0	<a href="#">Apache License 2.0</a> <sup>[332]</sup>
<b>Open Sans</b>	v1.10	<a href="#">SIL Open Font License 1.1</a> <sup>[369]</sup>
<b>OpenSceneGraph</b>		
OpenSceneGraph (OSG)	3.4.0	<a href="#">GNU Lesser General Public License 2.1 Altered</a> <sup>[343]</sup>
<b>USB4Java</b>	1.3.0	<a href="#">MIT License</a> <sup>[358]</sup>
Ubuntu OS	22.04	Ubuntu Open Source License

## 2 Clause BSD License Altered (JOGL)

The JOGL source code is mostly licensed under the 'New BSD 2-Clause License', however it contains other licensed material as well. Other licensed material is compatible with the 'New BSD 2-Clause License', if not stated otherwise. 'New BSD 2-Clause License' incompatible materials are optional, they are:

A.7) The JOGL source tree `_may_` contain code from Oculus VR, Inc. which is covered by it's own permissive Oculus VR Rift SDK Software License. (Optional, see A.7 below for details) Below you find a detailed list of licenses used in this project.

The content of folder 'make/lib' contains build- and test-time only Java binaries (JAR) to ease the build setup.

Each JAR file has it's corresponding LICENSE file containing the source location and license text. None of these binaries are contained in any way by the generated and deployed JOGL binaries.

L.1) The JOGL source tree contains code from the JogAmp Community which is covered by the Simplified BSD 2-clause license: Copyright 2009-2024 JogAmp Community. All rights reserved.

Redistribution and use in source and binary forms, with or without modification, are permitted provided that the following conditions are met:

1. Redistributions of source code must retain the above copyright notice, this list of conditions and the following disclaimer.

2. Redistributions in binary form must reproduce the above copyright notice, this list of conditions and the following disclaimer in the documentation and/or other materials provided with the distribution.

THIS SOFTWARE IS PROVIDED BY JogAmp Community ``AS IS'' AND ANY EXPRESS OR IMPLIED WARRANTIES, INCLUDING, BUT NOT LIMITED TO, THE IMPLIED WARRANTIES OF MERCHANTABILITY AND FITNESS FOR A PARTICULAR PURPOSE ARE DISCLAIMED. IN NO EVENT SHALL JogAmp Community OR CONTRIBUTORS BE LIABLE FOR ANY DIRECT, INDIRECT, INCIDENTAL, SPECIAL, EXEMPLARY, OR CONSEQUENTIAL DAMAGES (INCLUDING, BUT NOT LIMITED TO, PROCUREMENT OF SUBSTITUTE GOODS OR SERVICES; LOSS OF USE, DATA, OR PROFITS; OR BUSINESS INTERRUPTION) HOWEVER CAUSED AND ON ANY THEORY OF LIABILITY, WHETHER IN CONTRACT, STRICT LIABILITY, OR TORT (INCLUDING NEGLIGENCE OR OTHERWISE) ARISING IN ANY WAY OUT OF THE USE OF THIS SOFTWARE, EVEN IF ADVISED OF THE POSSIBILITY OF SUCH DAMAGE.

The views and conclusions contained in the software and documentation are those of the authors and should not be interpreted as representing official policies, either expressed or implied, of JogAmp Community.

You can address the JogAmp Community via:

Web <https://jogamp.org/>

Forum/Mailinglist <https://forum.jogamp.org>

Repository <https://jogamp.org/git/>

Wiki <https://jogamp.org/wiki/>

Maintainer [https://jogamp.org/wiki/index.php/Maintainer\\_and\\_Contacts](https://jogamp.org/wiki/index.php/Maintainer_and_Contacts)

L.2) The JOGL source tree contains code from Sun Microsystems, Inc. which is covered by the New BSD 3-clause license:

Copyright (c) 2003-2009 Sun Microsystems, Inc. All Rights Reserved.

Redistribution and use in source and binary forms, with or without modification, are permitted provided that the following conditions are met:

- Redistribution of source code must retain the above copyright notice, this list of conditions and the following disclaimer.

- Redistribution in binary form must reproduce the above copyright notice, this list of conditions and the following disclaimer in the documentation and/or other materials provided with the distribution.

Neither the name of Sun Microsystems, Inc. or the names of contributors may be used to endorse or promote products derived from this software without specific prior written permission.

This software is provided "AS IS," without a warranty of any kind. ALL EXPRESS OR IMPLIED CONDITIONS, REPRESENTATIONS AND WARRANTIES, INCLUDING ANY IMPLIED WARRANTY OF MERCHANTABILITY, FITNESS FOR A PARTICULAR PURPOSE OR NON-INFRINGEMENT, ARE HEREBY EXCLUDED. SUN MICROSYSTEMS, INC. ("SUN") AND ITS LICENSORS SHALL NOT BE LIABLE FOR ANY DAMAGES SUFFERED BY LICENSEE AS A RESULT OF USING, MODIFYING OR DISTRIBUTING THIS SOFTWARE OR ITS DERIVATIVES. IN NO EVENT WILL SUN OR ITS LICENSORS BE LIABLE FOR ANY LOST REVENUE, PROFIT OR DATA, OR FOR DIRECT, INDIRECT, SPECIAL, CONSEQUENTIAL, INCIDENTAL OR PUNITIVE DAMAGES, HOWEVER CAUSED AND REGARDLESS OF THE THEORY OF LIABILITY, ARISING OUT OF THE USE OF OR INABILITY TO USE THIS SOFTWARE, EVEN IF SUN HAS BEEN ADVISED OF THE POSSIBILITY OF SUCH DAMAGES.

You acknowledge that this software is not designed or intended for use in the design, construction, operation or maintenance of any nuclear facility.

L.3) The JOGL source tree contains code ported from the OpenGL sample implementation by Silicon Graphics, Inc. This code is licensed under the SGI Free Software License B, Version 2.0 License Applicability. Except to the extent portions of this file are made subject to an alternative license as permitted in the SGI Free Software License B, Version 2.0 (the "License"), the contents of this file are subject only to the provisions of the License. You may not use this file except in compliance with the License. You may obtain a copy of the License at Silicon Graphics, Inc., attn: Legal Services, 1600 Amphitheatre Parkway, Mountain View, CA 94043-1351, or at:

<http://oss.sgi.com/projects/FreeB>  
<http://oss.sgi.com/projects/FreeB/SGIFreeSWLicB.2.0.pdf>  
Or within this repository: <doc/licenses/SGIFreeSWLicB.2.0.pdf>

Note that, as provided in the License, the Software is distributed on an "AS IS" basis, with ALL EXPRESS AND IMPLIED WARRANTIES AND CONDITIONS DISCLAIMED, INCLUDING, WITHOUT LIMITATION, ANY IMPLIED WARRANTIES AND CONDITIONS OF MERCHANTABILITY, SATISFACTORY QUALITY, FITNESS FOR A PARTICULAR PURPOSE, AND NON-INFRINGEMENT.

L.4) The JOGL source tree contains code from the LWJGL project which is similarly covered by the New BSD 3-clause license: Copyright (c) 2002-2004 LWJGL Project. All rights reserved.

Redistribution and use in source and binary forms, with or without modification, are permitted provided that the following conditions are met:

- \* Redistributions of source code must retain the above copyright notice, this list of conditions and the following disclaimer.

- \* Redistributions in binary form must reproduce the above copyright notice, this list of conditions and the following disclaimer in the documentation and/or other materials provided with the distribution.

- \* Neither the name of 'LWJGL' nor the names of its contributors may be used to endorse or promote products derived from this software without specific prior written permission.

THIS SOFTWARE IS PROVIDED BY THE COPYRIGHT HOLDERS AND CONTRIBUTORS "AS IS" AND ANY EXPRESS OR IMPLIED WARRANTIES, INCLUDING, BUT NOT LIMITED TO, THE IMPLIED WARRANTIES OF MERCHANTABILITY AND FITNESS FOR A PARTICULAR PURPOSE ARE DISCLAIMED. IN NO EVENT SHALL THE COPYRIGHT OWNER OR CONTRIBUTORS BE LIABLE FOR ANY DIRECT, INDIRECT, INCIDENTAL, SPECIAL, EXEMPLARY, OR CONSEQUENTIAL DAMAGES (INCLUDING, BUT NOT LIMITED TO, PROCUREMENT OF SUBSTITUTE GOODS OR SERVICES; LOSS OF USE, DATA, OR PROFITS; OR BUSINESS INTERRUPTION) HOWEVER CAUSED AND ON ANY THEORY OF LIABILITY, WHETHER IN CONTRACT, STRICT LIABILITY, OR TORT (INCLUDING NEGLIGENCE OR OTHERWISE) ARISING IN ANY WAY OUT OF THE USE OF THIS SOFTWARE, EVEN IF ADVISED OF THE POSSIBILITY OF SUCH DAMAGE.

L.5) The JOGL source tree also contains a Java port of Brian Paul's Tile Rendering library, used with permission of the author under the New BSD 3-clause license instead of the original LGPL: Copyright (c) 1997-2005 Brian Paul. All Rights Reserved. Redistribution and use in source and binary forms, with or without modification, are permitted provided that the following conditions are met:

- Redistribution of source code must retain the above copyright notice, this list of conditions and the following disclaimer.

- Redistribution in binary form must reproduce the above copyright notice, this list of conditions and the following disclaimer in the documentation and/or other materials provided with the distribution.

Neither the name of Brian Paul or the names of contributors may be used to endorse or promote products derived from this software without specific prior written permission.

This software is provided "AS IS," without a warranty of any kind. ALL EXPRESS OR IMPLIED CONDITIONS, REPRESENTATIONS AND WARRANTIES, INCLUDING ANY IMPLIED WARRANTY OF MERCHANTABILITY, FITNESS FOR A PARTICULAR PURPOSE OR NON-INFRINGEMENT, ARE HEREBY EXCLUDED. THE COPYRIGHT HOLDERS AND CONTRIBUTORS SHALL NOT BE LIABLE FOR ANY DAMAGES SUFFERED BY LICENSEE AS A RESULT OF USING, MODIFYING OR DISTRIBUTING THIS SOFTWARE OR ITS DERIVATIVES. IN NO EVENT WILL THE COPYRIGHT HOLDERS OR CONTRIBUTORS BE LIABLE FOR ANY LOST REVENUE, PROFIT OR DATA, OR FOR DIRECT, INDIRECT, SPECIAL, CONSEQUENTIAL, INCIDENTAL OR PUNITIVE DAMAGES, HOWEVER CAUSED AND REGARDLESS OF THE THEORY OF LIABILITY, ARISING OUT OF THE USE OF OR INABILITY TO USE THIS SOFTWARE, EVEN IF THE COPYRIGHT HOLDERS OR CONTRIBUTORS HAVE BEEN ADVISED OF THE POSSIBILITY OF SUCH DAMAGES.

A.1) The JOGL source tree also contains header files from Khronos, reflecting OpenKODE, EGL, OpenGL ES1, OpenGL ES2 and OpenGL.

<http://www.khronos.org/legal/license/>

Files:

- make/stub\_includes/opengl/\*\*

- make/stub\_includes/egl/\*\*

- make/stub\_includes/khr/\*\*

- make/stub\_includes/openmax/\*\*

Copyright (c) 2007-2010 The Khronos Group Inc.

Permission is hereby granted, free of charge, to any person obtaining a copy of this software and/or associated documentation files (the "Materials"), to deal in the Materials without restriction, including without limitation the rights to use, copy, modify, merge, publish, distribute, sublicense, and/or sell copies of the Materials, and to permit persons to whom the Materials are furnished to do so, subject to the following conditions:

The above copyright notice and this permission notice shall be included in all copies or substantial portions of the Materials.

THE MATERIALS ARE PROVIDED "AS IS", WITHOUT WARRANTY OF ANY KIND, EXPRESS OR IMPLIED, INCLUDING BUT NOT LIMITED TO THE WARRANTIES OF MERCHANTABILITY, FITNESS FOR A PARTICULAR PURPOSE AND NON-INFRINGEMENT. IN NO EVENT SHALL THE AUTHORS OR COPYRIGHT HOLDERS BE LIABLE FOR ANY CLAIM, DAMAGES OR OTHER LIABILITY, WHETHER IN AN ACTION OF CONTRACT, TORT OR OTHERWISE, ARISING FROM, OUT OF OR IN CONNECTION WITH THE MATERIALS OR THE USE OR OTHER DEALINGS IN THE MATERIALS.

A.2) The JOGL source tree contains code from The Apache Software Foundation which is covered by the Apache License Version 2.0 Apache Harmony - Open Source Java SE

<<http://harmony.apache.org/>>

Author: The Apache Software Foundation (<http://www.apache.org/>).

Copyright 2006, 2010 The Apache Software Foundation.

Apache License Version 2.0, January 2004  
<http://www.apache.org/licenses/LICENSE-2.0>  
Or within this repository: doc/licenses/Apache.LICENSE-2.0  
Files:

- src/jogamp/graph/geom/plane/AffineTransform.java
- src/jogamp/graph/geom/plane/IllegalPathStateException.java
- src/jogamp/graph/geom/plane/NoninvertibleTransformException.java
- src/jogamp/graph/geom/plane/PathIterator.java
- src/jogamp/graph/geom/plane/Path2D.java
- src/jogamp/graph/math/plane/Crossing.java
- src/org/apache/harmony/misc/HashCode.java

A.3) The JOGL source tree contains code from David Schweinsberg which is covered by the Apache License Version 1.1 and Version 2.0 Typecast

Typecast is a font development environment for OpenType font technology.  
Upstream <<https://github.com/dcsch/typecast>>  
JOGL Patches <[https://jogamp.org/cgi/typecast.git/log/?h=jogl\\_patches](https://jogamp.org/cgi/typecast.git/log/?h=jogl_patches)>  
Aligned with jogl\_patches, commit 90c4a8348cbe182bf3f0bcc55fd015f19ed0686f  
Author: David Schweinsberg  
Copyright (C) 1999-2003 The Apache Software Foundation. All rights reserved.

Apache Licenses  
<http://www.apache.org/licenses/>  
Apache License Version 1.1  
<http://www.apache.org/licenses/LICENSE-1.1>  
Or within this repository: doc/licenses/Apache.LICENSE-1.1  
Files:

- src/jogl/classes/jogamp/graph/font/typecast/ot/\*
- src/jogl/classes/jogamp/graph/font/typecast/ot/table/\*

Apache License Version 2.0  
<http://www.apache.org/licenses/LICENSE-2.0>  
Or within this repository: doc/licenses/Apache.LICENSE-2.0

- src/jogl/classes/jogamp/graph/font/typecast/ot/\*
- src/jogl/classes/jogamp/graph/font/typecast/ot/mac/\*
- src/jogl/classes/jogamp/graph/font/typecast/ot/table/\*
- src/jogl/classes/jogamp/graph/font/typecast/tt/engine/\*

A.4) The JOGL source tree contains fonts from Ubuntu which is covered by the UBUNTU FONT LICENCE Version 1.0

Ubuntu Font Family

The Ubuntu Font Family are libre fonts funded by Canonical Ltd on behalf of the Ubuntu project.

<<http://font.ubuntu.com/>>  
Copyright 2010 Canonical Ltd.  
Licensed under the Ubuntu Font Licence 1.0  
Author: Canonical Ltd., Dalton Maag  
UBUNTU FONT LICENCE  
Version 1.0  
<http://font.ubuntu.com/ufl/ubuntu-font-licence-1.0.txt>  
Or within this repository: doc/licenses/ubuntu-font-licence-1.0.txt  
Files:  
src/jogamp/graph/font/fonts/ubuntu/\*

A.5) The JOGL source tree also contains header files from NVIDIA, reflecting Cg.

Files:  
make/stub\_includes/cg/CG/\*\*  
Copyright (c) 2002, NVIDIA Corporation

NVIDIA Corporation("NVIDIA") supplies this software to you in consideration of your agreement to the following terms, and your use, installation, modification or redistribution of this NVIDIA software constitutes acceptance of these terms. If you do not agree with these terms, please do not use, install, modify or redistribute this NVIDIA software.

In consideration of your agreement to abide by the following terms, and subject to these terms, NVIDIA grants you a personal, non-exclusive license, under NVIDIA's copyrights in this original NVIDIA software (the "NVIDIA Software"), to use, reproduce, modify and redistribute the NVIDIA Software, with or without modifications, in source and/or binary forms; provided that if you redistribute the NVIDIA Software, you must retain the copyright notice of NVIDIA, this notice and the following text and disclaimers in all such redistributions of the NVIDIA Software. Neither the name, trademarks, service marks nor logos of NVIDIA Corporation may be used to endorse or promote products derived from the NVIDIA Software without specific prior written permission from NVIDIA. Except as expressly stated in this notice, no other rights or licenses express or implied, are granted by NVIDIA herein, including but not limited to any patent rights that may be infringed by your derivative works or by other works in which the NVIDIA Software may be incorporated. No hardware is licensed hereunder.

THE NVIDIA SOFTWARE IS BEING PROVIDED ON AN "AS IS" BASIS, WITHOUT WARRANTIES OR CONDITIONS OF ANY KIND, EITHER EXPRESS OR IMPLIED, INCLUDING WITHOUT LIMITATION, WARRANTIES OR CONDITIONS OF TITLE, NON-INFRINGEMENT, MERCHANTABILITY, FITNESS FOR A PARTICULAR PURPOSE, OR ITS USE AND OPERATION EITHER ALONE OR IN COMBINATION WITH OTHER PRODUCTS.

IN NO EVENT SHALL NVIDIA BE LIABLE FOR ANY SPECIAL, INDIRECT, INCIDENTAL, EXEMPLARY, CONSEQUENTIAL DAMAGES (INCLUDING, BUT NOT LIMITED TO, LOST PROFITS; PROCUREMENT OF SUBSTITUTE GOODS OR SERVICES; LOSS OF USE, DATA, OR PROFITS; OR BUSINESS INTERRUPTION) OR ARISING IN ANY WAY OUT OF THE USE, REPRODUCTION, MODIFICATION AND/OR DISTRIBUTION OF THE NVIDIA SOFTWARE, HOWEVER CAUSED AND WHETHER UNDER THEORY OF CONTRACT, TORT (INCLUDING NEGLIGENCE), STRICT LIABILITY OR OTHERWISE, EVEN IF NVIDIA HAS BEEN ADVISED OF THE POSSIBILITY OF SUCH DAMAGE.

A.6) The JOGL source tree contains code from Hernan J. Gonzalez and Shawn Hartssock which is covered by the Apache License Version 2.0

PNGJ

PNGJ: Java library for reading and writing PNG images.

Version 1.12 (3 Dec 2012)

<<http://code.google.com/p/pngj/>>

Author: Hernan J. Gonzalez and Shawn Hartssock

Copyright (C) 2004 The Apache Software Foundation. All rights reserved.

Apache Licenses

<http://www.apache.org/licenses/>

Apache License Version 2.0

<http://www.apache.org/licenses/LICENSE-2.0>

Or within this repository: doc/licenses/Apache.LICENSE-2.0

src/jogl/classes/jogamp/opengl/util/pngj/\*\*

A.7) The JOGL source tree `_may_` contain code from Oculus VR, Inc. which is covered by it's own permissive Oculus VR Rift SDK Software License.

This code `_can_` be included to produce a binding and hence support for the Oculus VR Rift. The code is included `_and_` it's build artifacts will be released, if the git sub-module `oculusvr-sdk` is included in the jogl source repository as true for current official JogAmp builds and releases! If using JogAmp JOGL builds with `oculusvr-sdk` support, but the user prefers to `_not_` use it for license or other reasons, the user can simply remove the artifacts `'jar/atomics/oculusvr*jar'`. No other produced artifact is affected While the Oculus VR Rift SDK Software License is permissive, it's differences to the New BSD license shall be mentioned, see below!

Copyright © 2014 Oculus VR, Inc. All rights reserved. Oculus VR, Inc. Software Development Kit License Agreement

Human-Readable Summary:

- You are Free to:
  - Use, modify, and distribute the Oculus VR Rift SDK in source and binary form with your applications/software.
- With the Following Restrictions:
  - You can only distribute or re-distribute the source code to LibOVR in whole, not in part.
  - Modifications to the Oculus VR Rift SDK in source or binary form must be shared with Oculus VR.
  - If your applications cause health and safety issues, you may lose your right to use the Oculus VR Rift SDK, including LibOVR.
  - The Oculus VR Rift SDK may not be used to interface with unapproved commercial virtual reality mobile or non-mobile products or hardware.
- This human-readable Summary is not a license. It is simply a convenient reference for understanding the full Oculus VR Rift SDK License Agreement.

The Summary is written as a user-friendly interface to the full Oculus VR Rift SDK License below. This Summary itself has no legal value, and its contents do not appear in the actual license.

Full-length Legal Copy may be found at:

<http://www.oculusvr.com/licenses/LICENSE-3.1>

<http://jogamp.org/git/?p=oculusvr-sdk.git;a=blob;f=LICENSE.txt;hb=HEAD>

Or within this repository: `oculusvr-sdk/LICENSE.txt`

## 3 Clause BSD License (ControlsFX)

BSD 3-Clause License

Copyright (c) 2013, ControlsFX

All rights reserved.

Redistribution and use in source and binary forms, with or without modification, are permitted provided that the following conditions are met:

1. Redistributions of source code must retain the above copyright notice, this list of conditions and the following disclaimer.
2. Redistributions in binary form must reproduce the above copyright notice, this list of conditions and the following disclaimer in the documentation and/or other materials provided with the distribution.
3. Neither the name of ControlsFX, any associated website, nor the names of its contributors may be used to endorse or promote products derived from this software without specific prior written permission.

THIS SOFTWARE IS PROVIDED BY THE COPYRIGHT HOLDERS AND CONTRIBUTORS "AS IS" AND ANY EXPRESS OR IMPLIED WARRANTIES, INCLUDING, BUT NOT LIMITED TO, THE IMPLIED WARRANTIES OF MERCHANTABILITY AND FITNESS FOR A PARTICULAR PURPOSE ARE DISCLAIMED. IN NO EVENT SHALL THE COPYRIGHT HOLDER OR CONTRIBUTORS BE LIABLE FOR ANY DIRECT, INDIRECT, INCIDENTAL, SPECIAL, EXEMPLARY, OR CONSEQUENTIAL DAMAGES (INCLUDING, BUT NOT LIMITED TO, PROCUREMENT OF SUBSTITUTE GOODS OR SERVICES; LOSS OF USE, DATA, OR PROFITS; OR BUSINESS INTERRUPTION) HOWEVER CAUSED AND ON ANY THEORY OF LIABILITY, WHETHER IN CONTRACT, STRICT LIABILITY, OR TORT (INCLUDING NEGLIGENCE OR OTHERWISE) ARISING IN ANY WAY OUT OF THE USE OF THIS SOFTWARE, EVEN IF ADVISED OF THE POSSIBILITY OF SUCH DAMAGE.

## 3 Clause BSD License (libjpeg-turbo)

The Modified (3-clause) BSD License

Copyright (C)2009-2024 D. R. Commander. All Rights Reserved.

Copyright (C)2015 Viktor Szathmáry. All Rights Reserved.

Redistribution and use in source and binary forms, with or without modification, are permitted provided that the following conditions are met:

Redistributions of source code must retain the above copyright notice, this list of conditions and the following disclaimer.

Redistributions in binary form must reproduce the above copyright notice, this list of conditions and the following disclaimer in the documentation and/or other materials provided with the distribution.

Neither the name of the libjpeg-turbo Project nor the names of its contributors may be used to endorse or promote products derived from this software without specific prior written permission.

THIS SOFTWARE IS PROVIDED BY THE COPYRIGHT HOLDERS AND CONTRIBUTORS "AS IS", AND ANY EXPRESS OR IMPLIED WARRANTIES, INCLUDING, BUT NOT LIMITED TO, THE IMPLIED WARRANTIES OF MERCHANTABILITY AND FITNESS FOR A PARTICULAR PURPOSE ARE DISCLAIMED. IN NO EVENT SHALL THE COPYRIGHT HOLDERS OR CONTRIBUTORS BE LIABLE FOR ANY DIRECT, INDIRECT, INCIDENTAL, SPECIAL, EXEMPLARY, OR CONSEQUENTIAL DAMAGES (INCLUDING, BUT NOT LIMITED TO, PROCUREMENT OF SUBSTITUTE GOODS OR SERVICES; LOSS OF USE, DATA, OR PROFITS; OR BUSINESS INTERRUPTION) HOWEVER CAUSED AND ON ANY THEORY OF LIABILITY, WHETHER IN CONTRACT, STRICT LIABILITY, OR TORT (INCLUDING NEGLIGENCE OR OTHERWISE) ARISING IN ANY WAY OUT OF THE USE OF THIS SOFTWARE, EVEN IF ADVISED OF THE POSSIBILITY OF SUCH DAMAGE.

# Apache License 2.0

Apache License  
Version 2.0, January 2004

<http://www.apache.org/licenses/>

## TERMS AND CONDITIONS FOR USE, REPRODUCTION, AND DISTRIBUTION

### 1. Definitions.

"License" shall mean the terms and conditions for use, reproduction, and distribution as defined by Sections 1 through 9 of this document.

"Licensor" shall mean the copyright owner or entity authorized by the copyright owner that is granting the License.

"Legal Entity" shall mean the union of the acting entity and all other entities that control, are controlled by, or are under common control with that entity. For the purposes of this definition,

"control" means (i) the power, direct or indirect, to cause the direction or management of such entity, whether by contract or otherwise, or (ii) ownership of fifty percent (50%) or more of the outstanding shares, or (iii) beneficial ownership of such entity.

"You" (or "Your") shall mean an individual or Legal Entity exercising permissions granted by this License.

"Source" form shall mean the preferred form for making modifications, including but not limited to software source code, documentation source, and configuration files.

"Object" form shall mean any form resulting from mechanical transformation or translation of a Source form, including but not limited to compiled object code, generated documentation, and conversions to other media types.

"Work" shall mean the work of authorship, whether in Source or Object form, made available under the License, as indicated by a copyright notice that is included in or attached to the work (an example is provided in the Appendix below).

"Derivative Works" shall mean any work, whether in Source or Object form, that is based on (or derived from) the Work and for which the editorial revisions, annotations, elaborations, or other modifications represent, as a whole, an original work of authorship. For the purposes of this License, Derivative Works shall not include works that remain separable from, or merely link (or bind by name) to the interfaces of, the Work and Derivative Works thereof.

"Contribution" shall mean any work of authorship, including the original version of the Work and any modifications or additions to that Work or Derivative Works thereof, that is intentionally submitted to Licensor for inclusion in the Work by the copyright owner or by an individual or Legal Entity authorized to submit on behalf of the copyright owner. For the purposes of this definition, "submitted" means any form of electronic, verbal, or written communication sent to the Licensor or its representatives, including but not limited to communication on electronic mailing lists, source code control systems, and issue tracking systems that are managed by, or on behalf of, the Licensor for the purpose of discussing and improving the Work, but excluding communication that is conspicuously marked or otherwise designated in writing by the copyright owner as "Not a Contribution."

"Contributor" shall mean Licensor and any individual or Legal Entity on behalf of whom a Contribution has been received by Licensor and subsequently incorporated within the Work.

2. Grant of Copyright License. Subject to the terms and conditions of this License, each Contributor hereby grants to You a perpetual, worldwide, non-exclusive, no-charge, royalty-free, irrevocable copyright license to reproduce, prepare Derivative Works of, publicly display, publicly perform, sublicense, and distribute the Work and such Derivative Works in Source or Object form.

3. Grant of Patent License. Subject to the terms and conditions of this License, each Contributor hereby grants to You a perpetual, worldwide, non-exclusive, no-charge, royalty-free, irrevocable (except as stated in this section) patent license to make, have made, use, offer to sell, sell, import, and otherwise transfer the Work, where such license applies only to those patent claims licensable by such Contributor that are necessarily infringed by their Contribution(s) alone or by combination of their Contribution(s) with the Work to which such Contribution(s) was submitted. If You institute patent litigation against any entity (including a cross-claim or counterclaim in a lawsuit) alleging that the Work or a Contribution incorporated within the Work constitutes direct or contributory patent infringement, then any patent licenses granted to You under this License for that Work shall terminate as of the date such litigation is filed.

4. Redistribution. You may reproduce and distribute copies of the Work or Derivative Works thereof in any medium, with or without modifications, and in Source or Object form, provided that You meet the following conditions:

- (a) You must give any other recipients of the Work or Derivative Works a copy of this License; and
- (b) You must cause any modified files to carry prominent notices stating that You changed the files; and
- (c) You must retain, in the Source form of any Derivative Works that You distribute, all copyright, patent, trademark, and attribution notices from the Source form of the Work, excluding those notices that do not pertain to any part of the Derivative Works; and

- (d) If the Work includes a "NOTICE" text file as part of its distribution, then any Derivative Works that You distribute must include a readable copy of the attribution notices contained within such NOTICE file, excluding those notices that do not pertain to any part of the Derivative Works, in at least one of the following places: within a NOTICE text file distributed as part of the Derivative Works; within the Source form or documentation, if provided along with the Derivative Works; or, within a display generated by the Derivative Works, if and wherever such third-party notices normally appear. The contents of the NOTICE file are for informational purposes only and do not modify the License. You may add Your own attribution notices within Derivative Works that You distribute, alongside or as an addendum to the NOTICE text from the Work, provided that such additional attribution notices cannot be construed as modifying the License. You may add Your own copyright statement to Your modifications and may provide additional or different license terms and conditions for use, reproduction, or distribution of Your modifications, or for any such Derivative Works as a whole, provided Your use, reproduction, and distribution of the Work otherwise complies with the conditions stated in this License.

5. Submission of Contributions. Unless You explicitly state otherwise, any Contribution intentionally submitted for inclusion in the Work by You to the Licensor shall be under the terms and conditions of this License, without any additional terms or conditions. Notwithstanding the above, nothing herein shall supersede or modify the terms of any separate license agreement you may have executed with Licensor regarding such Contributions.

6. Trademarks. This License does not grant permission to use the trade names, trademarks, service marks, or product names of the Licensor, except as required for reasonable and customary use in describing the origin of the Work and reproducing the content of the NOTICE file.

7. Disclaimer of Warranty. Unless required by applicable law or agreed to in writing, Licensor provides the Work (and each Contributor provides its Contributions) on an "AS IS" BASIS, WITHOUT WARRANTIES OR CONDITIONS OF ANY KIND, either express or implied, including, without limitation, any warranties or conditions of TITLE, NON-INFRINGEMENT, MERCHANTABILITY, or FITNESS FOR A PARTICULAR PURPOSE.

You are solely responsible for determining the appropriateness of using or redistributing the Work and assume any risks associated with Your exercise of permissions under this License.

8. Limitation of Liability. In no event and under no legal theory, whether in tort (including negligence), contract, or otherwise, unless required by applicable law (such as deliberate and grossly negligent acts) or agreed to in writing, shall any Contributor be liable to You for damages, including any direct, indirect, special, incidental, or consequential damages of any character arising as a result of this License or out of the use or inability to use the Work (including but not limited to damages for loss of goodwill, work stoppage, computer failure or malfunction, or any and all other commercial damages or losses), even if such Contributor has been advised of the possibility of such damages.

9. Accepting Warranty or Additional Liability. While redistributing the Work or Derivative Works thereof, You may choose to offer, and charge a fee for, acceptance of support, warranty, indemnity, or other liability obligations and/or rights consistent with this License. However, in accepting such obligations, You may act only on Your own behalf and on Your sole responsibility, not on behalf of any other Contributor, and only if You agree to indemnify, defend, and hold each Contributor harmless for any liability incurred by, or claims asserted against, such Contributor by reason of your accepting any such warranty or additional liability.

END OF TERMS AND CONDITIONS

# Common Public License

Common Public License Version 1.0

Submitter: Dan Streetman, Steve Gerdt

SPDX short identifier: CPL-1.0

[Link to license steward's version](#)

Open Source Initiative Approved License

THE ACCOMPANYING PROGRAM IS PROVIDED UNDER THE TERMS OF THIS COMMON PUBLIC LICENSE ("AGREEMENT"). ANY USE, REPRODUCTION OR DISTRIBUTION OF THE PROGRAM CONSTITUTES RECIPIENT'S ACCEPTANCE OF THIS AGREEMENT.

## 1. DEFINITIONS "Contribution" means:

a) in the case of the initial Contributor, the initial code and documentation distributed under this Agreement, and

b) in the case of each subsequent Contributor: i) changes to the Program, and ii) additions to the Program; where such changes and/or additions to the Program originate from and are distributed by that particular Contributor. A Contribution 'originates' from a Contributor if it was added to the Program by such Contributor itself or anyone acting on such Contributor's behalf. Contributions do not include additions to the Program which: (i) are separate modules of software distributed in conjunction with the Program under their own license agreement, and (ii) are not derivative works of the Program. "Contributor" means any person or entity that distributes the Program. "Licensed Patents " mean patent claims licensable by a Contributor which are necessarily infringed by the use or sale of its Contribution alone or when combined with the Program. "Program" means the Contributions distributed in accordance with this Agreement. "Recipient" means anyone who receives the Program under this Agreement, including all Contributors.

## 2. GRANT OF RIGHTS

a) Subject to the terms of this Agreement, each Contributor hereby grants Recipient a non-exclusive, worldwide, royalty-free copyright license to reproduce, prepare derivative works of, publicly display, publicly perform, distribute and sublicense the Contribution of such Contributor, if any, and such derivative works, in source code and object code form.

b) Subject to the terms of this Agreement, each Contributor hereby grants Recipient a non-exclusive, worldwide, royalty-free patent license under Licensed Patents to make, use, sell, offer to sell, import and otherwise transfer the Contribution of such Contributor, if any, in source code and object code form. This patent license shall apply to the combination of the Contribution and the Program if, at the time the Contribution is added by the Contributor, such addition of the Contribution causes such combination to be covered by the Licensed Patents. The patent license shall not apply to any other combinations which include the Contribution. No hardware per se is licensed hereunder.

c) Recipient understands that although each Contributor grants the licenses to its Contributions set forth herein, no assurances are provided by any Contributor that the Program does not infringe the patent or other intellectual property rights of any other entity. Each Contributor disclaims any liability to Recipient for claims brought by any other entity based on infringement of intellectual property rights or otherwise. As a condition to exercising the rights and licenses granted hereunder, each Recipient hereby assumes sole responsibility to secure any other intellectual property rights needed, if any. For example, if a third party patent license is required to allow Recipient to distribute the Program, it is Recipient's responsibility to acquire that license before distributing the Program.

d) Each Contributor represents that to its knowledge it has sufficient copyright rights in its Contribution, if any, to grant the copyright license set forth in this Agreement.

3. REQUIREMENTS A Contributor may choose to distribute the Program in object code form under its own license agreement, provided that:

- a) it complies with the terms and conditions of this Agreement; and
- b) its license agreement:
  - i) effectively disclaims on behalf of all Contributors all warranties and conditions, express and implied, including warranties or conditions of title and non-infringement, and implied warranties or conditions of merchantability and fitness for a particular purpose;
  - ii) effectively excludes on behalf of all Contributors all liability for damages, including direct, indirect, special, incidental and consequential damages, such as lost profits;
  - iii) states that any provisions which differ from this Agreement are offered by that Contributor alone and not by any other party; and
  - iv) states that source code for the Program is available from such Contributor, and informs licensees how to obtain it in a reasonable manner on or through a medium customarily used for software exchange. When the Program is made available in source code form: a) it must be made available under this Agreement; and b) a copy of this Agreement must be included with each copy of the Program. Contributors may not remove or alter any copyright notices contained within the Program. Each Contributor must identify itself as the originator of its Contribution, if any, in a manner that reasonably allows subsequent Recipients to identify the originator of the Contribution.

4. COMMERCIAL DISTRIBUTION Commercial distributors of software may accept certain responsibilities with respect to end users, business partners and the like. While this license is intended to facilitate the commercial use of the Program, the Contributor who includes the Program in a commercial product offering should do so in a manner which does not create potential liability for other Contributors. Therefore, if a Contributor includes the Program in a commercial product offering, such Contributor ("Commercial Contributor") hereby agrees to defend and indemnify every other Contributor ("Indemnified Contributor") against any losses, damages and costs (collectively "Losses") arising from claims, lawsuits and other legal actions brought by a third party against the Indemnified Contributor to the extent caused by the acts or omissions of such Commercial Contributor in connection with its distribution of the Program in a commercial product offering. The obligations in this section do not apply to any claims or Losses relating to any actual or alleged intellectual property infringement. In order to qualify, an Indemnified Contributor must:

- a) promptly notify the Commercial Contributor in writing of such claim, and
- b) allow the Commercial Contributor to control, and cooperate with the Commercial Contributor in, the defense and any related settlement negotiations. The Indemnified Contributor may participate in any such claim at its own expense. For example, a Contributor might include the Program in a commercial product offering, Product X. That Contributor is then a Commercial Contributor. If that Commercial Contributor then makes performance claims, or offers warranties related to Product X, those performance claims and warranties are such Commercial Contributor's responsibility alone. Under this section, the Commercial Contributor would have to defend claims against the other Contributors related to those performance claims and warranties, and if a court requires any other Contributor to pay any damages as a result, the Commercial Contributor must pay those damages.

5. NO WARRANTY EXCEPT AS EXPRESSLY SET FORTH IN THIS AGREEMENT, THE PROGRAM IS PROVIDED ON AN "AS IS" BASIS, WITHOUT WARRANTIES OR CONDITIONS OF ANY KIND, EITHER EXPRESS OR IMPLIED INCLUDING, WITHOUT LIMITATION, ANY WARRANTIES OR CONDITIONS OF TITLE, NON-INFRINGEMENT, MERCHANTABILITY OR FITNESS FOR A PARTICULAR PURPOSE.

Each Recipient is solely responsible for determining the appropriateness of using and distributing the Program and assumes all risks associated with its exercise of rights under this Agreement, including but not limited to the risks and costs of program errors, compliance with applicable laws, damage to or loss of data, programs or equipment, and unavailability or interruption of operations.

6. DISCLAIMER OF LIABILITY EXCEPT AS EXPRESSLY SET FORTH IN THIS AGREEMENT, NEITHER RECIPIENT NOR ANY CONTRIBUTORS SHALL HAVE ANY LIABILITY FOR ANY DIRECT, INDIRECT, INCIDENTAL, SPECIAL,

EXEMPLARY, OR CONSEQUENTIAL DAMAGES (INCLUDING WITHOUT LIMITATION LOST PROFITS), HOWEVER CAUSED AND ON ANY THEORY OF LIABILITY, WHETHER IN CONTRACT, STRICT LIABILITY, OR TORT (INCLUDING NEGLIGENCE OR OTHERWISE) ARISING IN ANY WAY OUT OF THE USE OR DISTRIBUTION OF THE PROGRAM OR THE EXERCISE OF ANY RIGHTS GRANTED HEREUNDER, EVEN IF ADVISED OF THE POSSIBILITY OF SUCH DAMAGES.

7. GENERAL If any provision of this Agreement is invalid or unenforceable under applicable law, it shall not affect the validity or enforceability of the remainder of the terms of this Agreement, and without further action by the parties hereto, such provision shall be reformed to the minimum extent necessary to make such provision valid and enforceable. If Recipient institutes patent litigation against a Contributor with respect to a patent applicable to software (including a cross-claim or counterclaim in a lawsuit), then any patent licenses granted by that Contributor to such Recipient under this Agreement shall terminate as of the date such litigation is filed. In addition, if Recipient institutes patent litigation against any entity (including a cross-claim or counterclaim in a lawsuit) alleging that the Program itself (excluding combinations of the Program with other software or hardware) infringes such Recipient's patent(s), then such Recipient's rights granted under Section 2(b) shall terminate as of the date such litigation is filed. All Recipient's rights under this Agreement shall terminate if it fails to comply with any of the material terms or conditions of this Agreement and does not cure such failure in a reasonable period of time after becoming aware of such noncompliance. If all Recipient's rights under this Agreement terminate, Recipient agrees to cease use and distribution of the Program as soon as reasonably practicable. However, Recipient's obligations under this Agreement and any licenses granted by Recipient relating to the Program shall continue and survive. Everyone is permitted to copy and distribute copies of this Agreement, but in order to avoid inconsistency the Agreement is copyrighted and may only be modified in the following manner. The Agreement Steward reserves the right to publish new versions (including revisions) of this Agreement from time to time. No one other than the Agreement Steward has the right to modify this Agreement. IBM is the initial Agreement Steward. IBM may assign the responsibility to serve as the Agreement Steward to a suitable separate entity. Each new version of the Agreement will be given a distinguishing version number. The Program (including Contributions) may always be distributed subject to the version of the Agreement under which it was received. In addition, after a new version of the Agreement is published, Contributor may elect to distribute the Program (including its Contributions) under the new version. Except as expressly stated in Sections 2(a) and 2(b) above, Recipient receives no rights or licenses to the intellectual property of any Contributor under this Agreement, whether expressly, by implication, estoppel or otherwise. All rights in the Program not expressly granted under this Agreement are reserved. This Agreement is governed by the laws of the State of New York and the intellectual property laws of the United States of America. No party to this Agreement will bring a legal action under this Agreement more than one year after the cause of action arose. Each party waives its rights to a jury trial in any resulting litigation.

# Eclipse Public License 2.0

Eclipse Public License - v 2.0

THE ACCOMPANYING PROGRAM IS PROVIDED UNDER THE TERMS OF THIS ECLIPSE PUBLIC LICENSE ("AGREEMENT"). ANY USE, REPRODUCTION OR DISTRIBUTION OF THE PROGRAM CONSTITUTES RECIPIENT'S ACCEPTANCE OF THIS AGREEMENT.

## 1. DEFINITIONS

"Contribution" means:

- a) in the case of the initial Contributor, the initial content Distributed under this Agreement, and
- b) in the case of each subsequent Contributor:
  - i) changes to the Program, and
  - ii) additions to the Program;

where such changes and/or additions to the Program originate from and are Distributed by that particular Contributor. A Contribution "originates" from a Contributor if it was added to the Program by such Contributor itself or anyone acting on such Contributor's behalf. Contributions do not include changes or additions to the Program that are not Modified Works.

"Contributor" means any person or entity that Distributes the Program.

"Licensed Patents" mean patent claims licensable by a Contributor which are necessarily infringed by the use or sale of its Contribution alone or when combined with the Program.

"Program" means the Contributions Distributed in accordance with this Agreement.

"Recipient" means anyone who receives the Program under this Agreement or any Secondary License (as applicable), including Contributors.

"Derivative Works" shall mean any work, whether in Source Code or other form, that is based on (or derived from) the Program and for which the editorial revisions, annotations, elaborations, or other modifications represent, as a whole, an original work of authorship.

"Modified Works" shall mean any work in Source Code or other form that results from an addition to, deletion from, or modification of the contents of the Program, including, for purposes of clarity any new file in Source Code form that contains any contents of the Program. Modified Works shall not include works that contain only declarations, interfaces, types, classes, structures, or files of the Program solely in each case in order to link to, bind by name, or subclass the Program or Modified Works thereof.

"Distribute" means the acts of a) distributing or b) making available in any manner that enables the transfer of a copy.

"Source Code" means the form of a Program preferred for making modifications, including but not limited to software source code, documentation source, and configuration files.

"Secondary License" means either the GNU General Public License, Version 2.0, or any later versions of that license, including any exceptions or additional permissions as identified by the initial Contributor.

## 2. GRANT OF RIGHTS

- a) Subject to the terms of this Agreement, each Contributor hereby grants Recipient a non-exclusive, worldwide, royalty-free copyright license to reproduce, prepare Derivative Works of, publicly display, publicly perform, Distribute and sublicense the Contribution of such Contributor, if any, and such Derivative Works.

b) Subject to the terms of this Agreement, each Contributor hereby grants Recipient a non-exclusive, worldwide, royalty-free patent license under Licensed Patents to make, use, sell, offer to sell, import and otherwise transfer the Contribution of such Contributor, if any, in Source Code or other form. This patent license shall apply to the combination of the Contribution and the Program if, at the time the Contribution is added by the Contributor, such addition of the Contribution causes such combination to be covered by the Licensed Patents. The patent license shall not apply to any other combinations which include the Contribution. No hardware per se is licensed hereunder.

c) Recipient understands that although each Contributor grants the licenses to its Contributions set forth herein, no assurances are provided by any Contributor that the Program does not infringe the patent or other intellectual property rights of any other entity. Each Contributor disclaims any liability to Recipient for claims brought by any other entity based on infringement of intellectual property rights or otherwise. As a condition to exercising the rights and licenses granted hereunder, each Recipient hereby assumes sole responsibility to secure any other intellectual property rights needed, if any. For example, if a third party patent license is required to allow Recipient to Distribute the Program, it is Recipient's responsibility to acquire that license before distributing the Program.

d) Each Contributor represents that to its knowledge it has sufficient copyright rights in its Contribution, if any, to grant the copyright license set forth in this Agreement.

e) Notwithstanding the terms of any Secondary License, no Contributor makes additional grants to any Recipient (other than those set forth in this Agreement) as a result of such Recipient's receipt of the Program under the terms of a Secondary License (if permitted under the terms of Section 3).

### 3. REQUIREMENTS

3.1 If a Contributor Distributes the Program in any form, then:

a) the Program must also be made available as Source Code, in accordance with section 3.2, and the Contributor must accompany the Program with a statement that the Source Code for the Program is available under this Agreement, and informs Recipients how to obtain it in a reasonable manner on or through a medium customarily used for software exchange; and

b) the Contributor may Distribute the Program under a license different than this Agreement, provided that such license:

i) effectively disclaims on behalf of all other Contributors all warranties and conditions, express and implied, including warranties or conditions of title and non-infringement, and implied warranties or conditions of merchantability and fitness for a particular purpose;

ii) effectively excludes on behalf of all other Contributors all liability for damages, including direct, indirect, special, incidental and consequential damages, such as lost profits;

iii) does not attempt to limit or alter the recipients' rights in the Source Code under section 3.2; and

iv) requires any subsequent distribution of the Program by any party to be under a license that satisfies the requirements of this section 3.

3.2 When the Program is Distributed as Source Code:

a) it must be made available under this Agreement, or if the Program (i) is combined with other material in a separate file or files made available under a Secondary License, and (ii) the initial Contributor attached to the Source Code the notice described in Exhibit A of this Agreement, then the Program may be made available under the terms of such Secondary Licenses, and

b) a copy of this Agreement must be included with each copy of the Program.

3.3 Contributors may not remove or alter any copyright, patent, trademark, attribution notices, disclaimers of warranty, or limitations of liability ('notices') contained within the Program from any copy of the Program which they Distribute, provided that Contributors may add their own appropriate notices.

#### 4. COMMERCIAL DISTRIBUTION

Commercial distributors of software may accept certain responsibilities with respect to end users, business partners and the like. While this license is intended to facilitate the commercial use of the Program, the Contributor who includes the Program in a commercial product offering should do so in a manner which does not create potential liability for other Contributors. Therefore, if a Contributor includes the Program in a commercial product offering, such Contributor ("Commercial Contributor") hereby agrees to defend and indemnify every other Contributor ("Indemnified Contributor") against any losses, damages and costs (collectively "Losses") arising from claims, lawsuits and other legal actions brought by a third party against the Indemnified Contributor to the extent caused by the acts or omissions of such Commercial Contributor in connection with its distribution of the Program in a commercial product offering. The obligations in this section do not apply to any claims or Losses relating to any actual or alleged intellectual property infringement. In order to qualify, an Indemnified Contributor must: a) promptly notify the Commercial Contributor in writing of such claim, and b) allow the Commercial Contributor to control, and cooperate with the Commercial Contributor in, the defense and any related settlement negotiations. The Indemnified Contributor may participate in any such claim at its own expense.

For example, a Contributor might include the Program in a commercial product offering, Product X. That Contributor is then a Commercial Contributor. If that Commercial Contributor then makes performance claims, or offers warranties related to Product X, those performance claims and warranties are such Commercial Contributor's responsibility alone. Under this section, the Commercial Contributor would have to defend claims against the other Contributors related to those performance claims and warranties, and if a court requires any other Contributor to pay any damages as a result, the Commercial Contributor must pay those damages.

#### 5. NO WARRANTY

EXCEPT AS EXPRESSLY SET FORTH IN THIS AGREEMENT, AND TO THE EXTENT PERMITTED BY APPLICABLE LAW, THE PROGRAM IS PROVIDED ON AN "AS IS" BASIS, WITHOUT WARRANTIES OR CONDITIONS OF ANY KIND, EITHER EXPRESS OR IMPLIED INCLUDING, WITHOUT LIMITATION, ANY WARRANTIES OR CONDITIONS OF TITLE, NON-INFRINGEMENT, MERCHANTABILITY OR FITNESS FOR A PARTICULAR PURPOSE. Each Recipient is solely responsible for determining the appropriateness of using and distributing the Program and assumes all risks associated with its exercise of rights under this Agreement, including but not limited to the risks and costs of program errors, compliance with applicable laws, damage to or loss of data, programs or equipment, and unavailability or interruption of operations.

#### 6. DISCLAIMER OF LIABILITY

EXCEPT AS EXPRESSLY SET FORTH IN THIS AGREEMENT, AND TO THE EXTENT PERMITTED BY APPLICABLE LAW, NEITHER RECIPIENT NOR ANY CONTRIBUTORS SHALL HAVE ANY LIABILITY FOR ANY DIRECT, INDIRECT, INCIDENTAL, SPECIAL, EXEMPLARY, OR CONSEQUENTIAL DAMAGES (INCLUDING WITHOUT LIMITATION LOST PROFITS), HOWEVER CAUSED AND ON ANY THEORY OF LIABILITY, WHETHER IN CONTRACT, STRICT LIABILITY, OR TORT (INCLUDING NEGLIGENCE OR OTHERWISE) ARISING IN ANY WAY OUT OF THE USE OR DISTRIBUTION OF THE PROGRAM OR THE EXERCISE OF ANY RIGHTS GRANTED HEREUNDER, EVEN IF ADVISED OF THE POSSIBILITY OF SUCH DAMAGES.

#### 7. GENERAL

If any provision of this Agreement is invalid or unenforceable under applicable law, it shall not affect the validity or enforceability of the remainder of the terms of this Agreement, and without further action by the parties hereto, such provision shall be reformed to the minimum extent necessary to make such provision valid and enforceable.

If Recipient institutes patent litigation against any entity (including a cross-claim or counterclaim in a lawsuit) alleging that the Program itself (excluding combinations of the Program with other software or hardware) infringes such Recipient's patent(s), then such Recipient's rights granted under Section 2(b) shall terminate as of the date such litigation is filed.

All Recipient's rights under this Agreement shall terminate if it fails to comply with any of the material terms or conditions of this Agreement and does not cure such failure in a reasonable period of time after becoming aware of such noncompliance. If all Recipient's rights under this Agreement terminate, Recipient agrees to

cease use and distribution of the Program as soon as reasonably practicable. However, Recipient's obligations under this Agreement and any licenses granted by Recipient relating to the Program shall continue and survive.

Everyone is permitted to copy and distribute copies of this Agreement, but in order to avoid inconsistency the Agreement is copyrighted and may only be modified in the following manner. The Agreement Steward reserves the right to publish new versions (including revisions) of this Agreement from time to time. No one other than the Agreement Steward has the right to modify this Agreement. The Eclipse Foundation is the initial Agreement Steward. The Eclipse Foundation may assign the responsibility to serve as the Agreement Steward to a suitable separate entity. Each new version of the Agreement will be given a distinguishing version number. The Program (including Contributions) may always be Distributed subject to the version of the Agreement under which it was received. In addition, after a new version of the Agreement is published, Contributor may elect to Distribute the Program (including its Contributions) under the new version.

Except as expressly stated in Sections 2(a) and 2(b) above, Recipient receives no rights or licenses to the intellectual property of any Contributor under this Agreement, whether expressly, by implication, estoppel or otherwise. All rights in the Program not expressly granted under this Agreement are reserved. Nothing in this Agreement is intended to be enforceable by any entity that is not a Contributor or Recipient. No third-party beneficiary rights are created under this Agreement.

#### Exhibit A – Form of Secondary Licenses Notice

"This Source Code may also be made available under the following Secondary Licenses when the conditions for such availability set forth in the Eclipse Public License, v. 2.0 are satisfied: {name license(s), version(s), and exceptions or additional permissions here}."

Simply including a copy of this Agreement, including this Exhibit A is not sufficient to license the Source Code under Secondary Licenses.

If it is not possible or desirable to put the notice in a particular file, then You may include the notice in a location (such as a LICENSE file in a relevant directory) where a recipient would be likely to look for such a notice.

You may add additional accurate notices of copyright ownership.

# Eclipse Distribution License 1.0

Eclipse Distribution License - v 1.0

Copyright (c) 2007, Eclipse Foundation, Inc. and its licensors.

All rights reserved.

Redistribution and use in source and binary forms, with or without modification, are permitted provided that the following conditions are met:

Redistributions of source code must retain the above copyright notice, this list of conditions and the following disclaimer.

Redistributions in binary form must reproduce the above copyright notice, this list of conditions and the following disclaimer in the documentation and/or other materials provided with the distribution.

Neither the name of the Eclipse Foundation, Inc. nor the names of its contributors may be used to endorse or promote products derived from this software without specific prior written permission.

THIS SOFTWARE IS PROVIDED BY THE COPYRIGHT HOLDERS AND CONTRIBUTORS "AS IS" AND ANY EXPRESS OR IMPLIED WARRANTIES, INCLUDING, BUT NOT LIMITED TO, THE IMPLIED WARRANTIES OF MERCHANTABILITY AND FITNESS FOR A PARTICULAR PURPOSE ARE DISCLAIMED. IN NO EVENT SHALL THE COPYRIGHT OWNER OR CONTRIBUTORS BE LIABLE FOR ANY DIRECT, INDIRECT, INCIDENTAL, SPECIAL, EXEMPLARY, OR CONSEQUENTIAL DAMAGES (INCLUDING, BUT NOT LIMITED TO, PROCUREMENT OF SUBSTITUTE GOODS OR SERVICES; LOSS OF USE, DATA, OR PROFITS; OR BUSINESS INTERRUPTION) HOWEVER CAUSED AND ON ANY THEORY OF LIABILITY, WHETHER IN CONTRACT, STRICT LIABILITY, OR TORT (INCLUDING NEGLIGENCE OR OTHERWISE) ARISING IN ANY WAY OUT OF THE USE OF THIS SOFTWARE, EVEN IF ADVISED OF THE POSSIBILITY OF SUCH DAMAGE.

OSI Approved

The Eclipse Distribution License is an OSI Approved Open Source License by means of the New BSD License.

# GNU Lesser General Public License 2.1 Altered (OpenSceneGraph)

GNU LESSER GENERAL PUBLIC LICENSE

Version 2.1, February 1999

Copyright (C) 1991, 1999 Free Software Foundation, Inc.

51 Franklin Street, Fifth Floor, Boston, MA 02110-1301 USA

Everyone is permitted to copy and distribute verbatim copies of this license document, but changing it is not allowed.

[This is the first released version of the Lesser GPL. It also counts as the successor of the GNU Library Public License, version 2, hence the version number 2.1.]

## Preamble

The licenses for most software are designed to take away your freedom to share and change it. By contrast, the GNU General Public Licenses are intended to guarantee your freedom to share and change free software--to make sure the software is free for all its users.

This license, the Lesser General Public License, applies to some specially designated software packages--typically libraries--of the Free Software Foundation and other authors who decide to use it. You can use it too, but we suggest you first think carefully about whether this license or the ordinary General Public License is the better strategy to use in any particular case, based on the explanations below.

When we speak of free software, we are referring to freedom of use, not price. Our General Public Licenses are designed to make sure that you have the freedom to distribute copies of free software (and charge for this service if you wish); that you receive source code or can get it if you want it; that you can change the software and use pieces of it in new free programs; and that you are informed that you can do these things.

To protect your rights, we need to make restrictions that forbid distributors to deny you these rights or to ask you to surrender these rights. These restrictions translate to certain responsibilities for you if you distribute copies of the library or if you modify it.

For example, if you distribute copies of the library, whether gratis or for a fee, you must give the recipients all the rights that we gave you. You must make sure that they, too, receive or can get the source code. If you link other code with the library, you must provide complete object files to the recipients, so that they can relink them with the library after making changes to the library and recompiling it. And you must show them these terms so they know their rights.

We protect your rights with a two-step method: (1) we copyright the library, and (2) we offer you this license, which gives you legal permission to copy, distribute and/or modify the library.

To protect each distributor, we want to make it very clear that there is no warranty for the free library. Also, if the library is modified by someone else and passed on, the recipients should know that what they have is not the original version, so that the original author's reputation will not be affected by problems that might be introduced by others.

Finally, software patents pose a constant threat to the existence of any free program. We wish to make sure that a company cannot effectively restrict the users of a free program by obtaining a restrictive license from a patent holder. Therefore, we insist that any patent license obtained for a version of the library must be consistent with the full freedom of use specified in this license.

Most GNU software, including some libraries, is covered by the ordinary GNU General Public License. This license, the GNU Lesser General Public License, applies to certain designated libraries, and is quite different

from the ordinary General Public License. We use this license for certain libraries in order to permit linking those libraries into non-free programs.

When a program is linked with a library, whether statically or using a shared library, the combination of the two is legally speaking a combined work, a derivative of the original library. The ordinary General Public License therefore permits such linking only if the entire combination fits its criteria of freedom. The Lesser General Public License permits more lax criteria for linking other code with the library.

We call this license the "Lesser" General Public License because it does Less to protect the user's freedom than the ordinary General Public License. It also provides other free software developers Less of an advantage over competing non-free programs. These disadvantages are the reason we use the ordinary General Public License for many libraries. However, the Lesser license provides advantages in certain special circumstances.

For example, on rare occasions, there may be a special need to encourage the widest possible use of a certain library, so that it becomes a de-facto standard. To achieve this, non-free programs must be allowed to use the library. A more frequent case is that a free library does the same job as widely used non-free libraries. In this case, there is little to gain by limiting the free library to free software only, so we use the Lesser General Public License.

In other cases, permission to use a particular library in non-free programs enables a greater number of people to use a large body of free software. For example, permission to use the GNU C Library in non-free programs enables many more people to use the whole GNU operating system, as well as its variant, the GNU/Linux operating system.

Although the Lesser General Public License is Less protective of the users' freedom, it does ensure that the user of a program that is linked with the Library has the freedom and the wherewithal to run that program using a modified version of the Library.

The precise terms and conditions for copying, distribution and modification follow. Pay close attention to the difference between a "work based on the library" and a "work that uses the library". The former contains code derived from the library, whereas the latter must be combined with the library in order to run.

#### GNU LESSER GENERAL PUBLIC LICENSE TERMS AND CONDITIONS FOR COPYING, DISTRIBUTION AND MODIFICATION

0. This License Agreement applies to any software library or other program which contains a notice placed by the copyright holder or other authorized party saying it may be distributed under the terms of this Lesser General Public License (also called "this License"). Each licensee is addressed as "you".

A "library" means a collection of software functions and/or data prepared so as to be conveniently linked with application programs (which use some of those functions and data) to form executables.

The "Library", below, refers to any such software library or work which has been distributed under these terms. A "work based on the Library" means either the Library or any derivative work under copyright law: that is to say, a work containing the Library or a portion of it, either verbatim or with modifications and/or translated straightforwardly into another language. (Hereinafter, translation is included without limitation in the term "modification".)

"Source code" for a work means the preferred form of the work for making modifications to it. For a library, complete source code means all the source code for all modules it contains, plus any associated interface definition files, plus the scripts used to control compilation and installation of the library.

Activities other than copying, distribution and modification are not covered by this License; they are outside its scope. The act of running a program using the Library is not restricted, and output from such a program is covered only if its contents constitute a work based on the Library (independent of the use of the Library in a tool for writing it). Whether that is true depends on what the Library does and what the program that uses the Library does.

1. You may copy and distribute verbatim copies of the Library's complete source code as you receive it, in any medium, provided that you conspicuously and appropriately publish on each copy an appropriate

copyright notice and disclaimer of warranty; keep intact all the notices that refer to this License and to the absence of any warranty; and distribute a copy of this License along with the Library.

You may charge a fee for the physical act of transferring a copy, and you may at your option offer warranty protection in exchange for a fee.

2. You may modify your copy or copies of the Library or any portion of it, thus forming a work based on the Library, and copy and distribute such modifications or work under the terms of Section 1 above, provided that you also meet all of these conditions:

a) The modified work must itself be a software library.

b) You must cause the files modified to carry prominent notices stating that you changed the files and the date of any change.

c) You must cause the whole of the work to be licensed at no charge to all third parties under the terms of this License.

d) If a facility in the modified Library refers to a function or a table of data to be supplied by an application program that uses the facility, other than as an argument passed when the facility is invoked, then you must make a good faith effort to ensure that, in the event an application does not supply such function or table, the facility still operates, and performs whatever part of its purpose remains meaningful.

(For example, a function in a library to compute square roots has a purpose that is entirely well-defined independent of the application. Therefore, Subsection 2d requires that any application-supplied function or table used by this function must be optional: if the application does not supply it, the square root function must still compute square roots.)

These requirements apply to the modified work as a whole. If identifiable sections of that work are not derived from the Library, and can be reasonably considered independent and separate works in themselves, then this License, and its terms, do not apply to those sections when you distribute them as separate works.

But when you distribute the same sections as part of a whole which is a work based on the Library, the distribution of the whole must be on the terms of this License, whose permissions for other licensees extend to the entire whole, and thus to each and every part regardless of who wrote it.

Thus, it is not the intent of this section to claim rights or contest your rights to work written entirely by you; rather, the intent is to exercise the right to control the distribution of derivative or collective works based on the Library.

In addition, mere aggregation of another work not based on the Library with the Library (or with a work based on the Library) on a volume of a storage or distribution medium does not bring the other work under the scope of this License.

3. You may opt to apply the terms of the ordinary GNU General Public License instead of this License to a given copy of the Library. To do this, you must alter all the notices that refer to this License, so that they refer to the ordinary GNU General Public License, version 2, instead of to this License. (If a newer version than version 2 of the ordinary GNU General Public License has appeared, then you can specify that version instead if you wish.) Do not make any other change in these notices.

Once this change is made in a given copy, it is irreversible for that copy, so the ordinary GNU General Public License applies to all subsequent copies and derivative works made from that copy.

This option is useful when you wish to copy part of the code of the Library into a program that is not a library.

4. You may copy and distribute the Library (or a portion or derivative of it, under Section 2) in object code or executable form under the terms of Sections 1 and 2 above provided that you accompany it with the complete corresponding machine-readable source code, which must be distributed under the terms of Sections 1 and 2 above on a medium customarily used for software interchange.

If distribution of object code is made by offering access to copy from a designated place, then offering equivalent access to copy the source code from the same place satisfies the requirement to distribute the source code, even though third parties are not compelled to copy the source along with the object code.

5. A program that contains no derivative of any portion of the Library, but is designed to work with the Library by being compiled or linked with it, is called a "work that uses the Library". Such a work, in isolation, is not a derivative work of the Library, and therefore falls outside the scope of this License.

However, linking a "work that uses the Library" with the Library creates an executable that is a derivative of the Library (because it contains portions of the Library), rather than a "work that uses the library". The executable is therefore covered by this License.

Section 6 states terms for distribution of such executables.

When a "work that uses the Library" uses material from a header file that is part of the Library, the object code for the work may be a derivative work of the Library even though the source code is not. Whether this is true is especially significant if the work can be linked without the Library, or if the work is itself a library. The threshold for this to be true is not precisely defined by law.

If such an object file uses only numerical parameters, data structure layouts and accessors, and small macros and small inline functions (ten lines or less in length), then the use of the object file is unrestricted, regardless of whether it is legally a derivative work. (Executables containing this object code plus portions of the Library will still fall under Section 6.)

Otherwise, if the work is a derivative of the Library, you may distribute the object code for the work under the terms of Section 6. Any executables containing that work also fall under Section 6, whether or not they are linked directly with the Library itself.

6. As an exception to the Sections above, you may also combine or link a "work that uses the Library" with the Library to produce a work containing portions of the Library, and distribute that work under terms of your choice, provided that the terms permit modification of the work for the customer's own use and reverse engineering for debugging such modifications.

You must give prominent notice with each copy of the work that the Library is used in it and that the Library and its use are covered by this License. You must supply a copy of this License. If the work during execution displays copyright notices, you must include the copyright notice for the Library among them, as well as a reference directing the user to the copy of this License. Also, you must do one of these things:

a) Accompany the work with the complete corresponding machine-readable source code for the Library including whatever changes were used in the work (which must be distributed under Sections 1 and 2 above); and, if the work is an executable linked with the Library, with the complete machine-readable "work that uses the Library", as object code and/or source code, so that the user can modify the Library and then relink to produce a modified executable containing the modified Library. (It is understood that the user who changes the contents of definitions files in the Library will not necessarily be able to recompile the application to use the modified definitions.)

b) Use a suitable shared library mechanism for linking with the Library. A suitable mechanism is one that (1) uses at run time a copy of the library already present on the user's computer system, rather than copying library functions into the executable, and (2) will operate properly with a modified version of the library, if the user installs one, as long as the modified version is interface-compatible with the version that the work was made with.

c) Accompany the work with a written offer, valid for at least three years, to give the same user the materials specified in Subsection 6a, above, for a charge no more than the cost of performing this distribution.

d) If distribution of the work is made by offering access to copy from a designated place, offer equivalent access to copy the above specified materials from the same place.

e) Verify that the user has already received a copy of these materials or that you have already sent this user a copy.

For an executable, the required form of the "work that uses the Library" must include any data and utility programs needed for reproducing the executable from it. However, as a special exception, the materials to be distributed need not include anything that is normally distributed (in either source or binary form) with the major components (compiler, kernel, and so on) of the operating system on which the executable runs, unless that component itself accompanies the executable.

It may happen that this requirement contradicts the license restrictions of other proprietary libraries that do not normally accompany the operating system. Such a contradiction means you cannot use both them and the Library together in an executable that you distribute.

7. You may place library facilities that are a work based on the Library side-by-side in a single library together with other library facilities not covered by this License, and distribute such a combined library, provided that the separate distribution of the work based on the Library and of the other library facilities is otherwise permitted, and provided that you do these two things:

a) Accompany the combined library with a copy of the same work based on the Library, uncombined with any other library facilities. This must be distributed under the terms of the Sections above.

b) Give prominent notice with the combined library of the fact that part of it is a work based on the Library, and explaining where to find the accompanying uncombined form of the same work.

8. You may not copy, modify, sublicense, link with, or distribute the Library except as expressly provided under this License. Any attempt otherwise to copy, modify, sublicense, link with, or distribute the Library is void, and will automatically terminate your rights under this License. However, parties who have received copies, or rights, from you under this License will not have their licenses terminated so long as such parties remain in full compliance.

9. You are not required to accept this License, since you have not signed it. However, nothing else grants you permission to modify or distribute the Library or its derivative works. These actions are prohibited by law if you do not accept this License. Therefore, by modifying or distributing the Library (or any work based on the Library), you indicate your acceptance of this License to do so, and all its terms and conditions for copying, distributing or modifying the Library or works based on it.

10. Each time you redistribute the Library (or any work based on the Library), the recipient automatically receives a license from the original licensor to copy, distribute, link with or modify the Library subject to these terms and conditions. You may not impose any further restrictions on the recipients' exercise of the rights granted herein. You are not responsible for enforcing compliance by third parties with this License.

11. If, as a consequence of a court judgment or allegation of patent infringement or for any other reason (not limited to patent issues), conditions are imposed on you (whether by court order, agreement or otherwise) that contradict the conditions of this License, they do not excuse you from the conditions of this License. If you cannot distribute so as to satisfy simultaneously your obligations under this License and any other pertinent obligations, then as a consequence you may not distribute the Library at all. For example, if a patent license would not permit royalty-free redistribution of the Library by all those who receive copies directly or indirectly through you, then the only way you could satisfy both it and this License would be to refrain entirely from distribution of the Library.

If any portion of this section is held invalid or unenforceable under any particular circumstance, the balance of the section is intended to apply, and the section as a whole is intended to apply in other circumstances.

It is not the purpose of this section to induce you to infringe any patents or other property right claims or to contest validity of any such claims; this section has the sole purpose of protecting the integrity of the free software distribution system which is implemented by public license practices. Many people have made generous contributions to the wide range of software distributed through that system in reliance on consistent application of that system; it is up to the author/donor to decide if he or she is willing to distribute software through any other system and a licensee cannot impose that choice.

This section is intended to make thoroughly clear what is believed to be a consequence of the rest of this License.

12. If the distribution and/or use of the Library is restricted in certain countries either by patents or by copyrighted interfaces, the original copyright holder who places the Library under this License may add an explicit geographical distribution limitation excluding those countries, so that distribution is permitted only in or among countries not thus excluded. In such case, this License incorporates the limitation as if written in the body of this License.

13. The Free Software Foundation may publish revised and/or new versions of the Lesser General Public License from time to time. Such new versions will be similar in spirit to the present version, but may differ in detail to address new problems or concerns.

Each version is given a distinguishing version number. If the Library specifies a version number of this License which applies to it and "any later version", you have the option of following the terms and conditions either of that version or of any later version published by the Free Software Foundation. If the Library does not specify a license version number, you may choose any version ever published by the Free Software Foundation.

14. If you wish to incorporate parts of the Library into other free programs whose distribution conditions are incompatible with these, write to the author to ask for permission. For software which is copyrighted by the Free Software Foundation, write to the Free Software Foundation; we sometimes make exceptions for this. Our decision will be guided by the two goals of preserving the free status of all derivatives of our free software and of promoting the sharing and reuse of software generally.

#### NO WARRANTY

15. BECAUSE THE LIBRARY IS LICENSED FREE OF CHARGE, THERE IS NO WARRANTY FOR THE LIBRARY, TO THE EXTENT PERMITTED BY APPLICABLE LAW. EXCEPT WHEN OTHERWISE STATED IN WRITING THE COPYRIGHT HOLDERS AND/OR OTHER PARTIES PROVIDE THE LIBRARY "AS IS" WITHOUT WARRANTY OF ANY KIND, EITHER EXPRESSED OR IMPLIED, INCLUDING, BUT NOT LIMITED TO, THE IMPLIED WARRANTIES OF MERCHANTABILITY AND FITNESS FOR A PARTICULAR PURPOSE. THE ENTIRE RISK AS TO THE QUALITY AND PERFORMANCE OF THE LIBRARY IS WITH YOU. SHOULD THE LIBRARY PROVE DEFECTIVE, YOU ASSUME THE COST OF ALL NECESSARY SERVICING, REPAIR OR CORRECTION.

16. IN NO EVENT UNLESS REQUIRED BY APPLICABLE LAW OR AGREED TO IN WRITING WILL ANY COPYRIGHT HOLDER, OR ANY OTHER PARTY WHO MAY MODIFY AND/OR REDISTRIBUTE THE LIBRARY AS PERMITTED ABOVE, BE LIABLE TO YOU FOR DAMAGES, INCLUDING ANY GENERAL, SPECIAL, INCIDENTAL OR CONSEQUENTIAL DAMAGES ARISING OUT OF THE USE OR INABILITY TO USE THE LIBRARY (INCLUDING BUT NOT LIMITED TO LOSS OF DATA OR DATA BEING RENDERED INACCURATE OR LOSSES SUSTAINED BY YOU OR THIRD PARTIES OR A FAILURE OF THE LIBRARY TO OPERATE WITH ANY OTHER SOFTWARE), EVEN IF SUCH HOLDER OR OTHER PARTY HAS BEEN ADVISED OF THE POSSIBILITY OF SUCH DAMAGES.

END OF TERMS AND CONDITIONS

# GNU Lesser General Public License 3.0

GNU LESSER GENERAL PUBLIC LICENSE

Version 3, 29 June 2007

Copyright (C) 2007 Free Software Foundation, Inc. <<http://fsf.org/>>

Everyone is permitted to copy and distribute verbatim copies of this license document, but changing it is not allowed.

This version of the GNU Lesser General Public License incorporates the terms and conditions of version 3 of the GNU General Public

License, supplemented by the additional permissions listed below.

## 0. Additional Definitions.

As used herein, "this License" refers to version 3 of the GNU Lesser General Public License, and the "GNU GPL" refers to version 3 of the GNU

General Public License.

"The Library" refers to a covered work governed by this License, other than an Application or a Combined Work as defined below. An "Application" is any work that makes use of an interface provided by the Library, but which is not otherwise based on the Library. Defining a subclass of a class defined by the Library is deemed a mode of using an interface provided by the Library.

A "Combined Work" is a work produced by combining or linking an Application with the Library. The particular version of the Library with which the Combined Work was made is also called the "Linked Version".

The "Minimal Corresponding Source" for a Combined Work means the Corresponding Source for the Combined Work, excluding any source code for portions of the Combined Work that, considered in isolation, are based on the Application, and not on the Linked Version. The "Corresponding Application Code" for a Combined Work means the object code and/or source code for the Application, including any data and utility programs needed for reproducing the Combined Work from the Application, but excluding the System Libraries of the Combined Work.

1. Exception to Section 3 of the GNU GPL. You may convey a covered work under sections 3 and 4 of this License without being bound by section 3 of the GNU GPL.

2. Conveying Modified Versions. If you modify a copy of the Library, and, in your modifications, a facility refers to a function or data to be supplied by an Application that uses the facility (other than as an argument passed when the facility is invoked), then you may convey a copy of the modified

version:

a) under this License, provided that you make a good faith effort to ensure that, in the event an Application does not supply the function or data, the facility still operates, and performs whatever part of its purpose remains meaningful, or

b) under the GNU GPL, with none of the additional permissions of this License applicable to that copy.

3. Object Code Incorporating Material from Library Header Files. The object code form of an Application may incorporate material from a header file that is part of the Library. You may convey such object code under terms of your choice, provided that, if the incorporated material is not limited to numerical

parameters, data structure layouts and accessors, or small macros, inline functions and templates (ten or fewer lines in length), you do both of the following:

a) Give prominent notice with each copy of the object code that the Library is used in it and that the Library and its use are covered by this License.

b) Accompany the object code with a copy of the GNU GPL and this license document.

#### 4. Combined Works.

You may convey a Combined Work under terms of your choice that taken together, effectively do not restrict modification of the portions of the Library contained in the Combined Work and reverse engineering for debugging such modifications, if you also do each of the following:

a) Give prominent notice with each copy of the Combined Work that the Library is used in it and that the Library and its use are covered by this License.

b) Accompany the Combined Work with a copy of the GNU GPL and this license document.

c) For a Combined Work that displays copyright notices during execution, include the copyright notice for the Library among these notices, as well as a reference directing the user to the copies of the GNU GPL and this license document.

d) Do one of the following:

0) Convey the Minimal Corresponding Source under the terms of this License, and the Corresponding Application Code in a form suitable for, and under terms that permit, the user to recombine or relink the Application with a modified version of the Linked Version to produce a modified Combined Work, in the manner specified by section 6 of the GNU GPL for conveying Corresponding Source.

1) Use a suitable shared library mechanism for linking with the Library. A suitable mechanism is one that (a) uses at run time a copy of the Library already present on the user's computer system, and (b) will operate properly with a modified version of the Library that is interface-compatible with the Linked Version.

e) Provide Installation Information, but only if you would otherwise be required to provide such information under section 6 of the GNU GPL, and only to the extent that such information is necessary to install and execute a modified version of the Combined Work produced by recombining or relinking the Application with a modified version of the Linked Version. (If you use option 4d0, the Installation Information must accompany the Minimal Corresponding Source and Corresponding Application Code. If you use option 4d1, you must provide the Installation Information in the manner specified by section 6 of the GNU GPL for conveying Corresponding Source.)

5. Combined Libraries. You may place library facilities that are a work based on the Library side by side in a single library together with other library facilities that are not Applications and are not covered by this License, and convey such a combined library under terms of your choice, if you do both of the following:

a) Accompany the combined library with a copy of the same work based on the Library, uncombined with any other library facilities, conveyed under the terms of this License.

b) Give prominent notice with the combined library that part of it is a work based on the Library, and explaining where to find the accompanying uncombined form of the same work.

6. Revised Versions of the GNU Lesser General Public License. The Free Software Foundation may publish revised and/or new versions

of the GNU Lesser General Public License from time to time. Such new versions will be similar in spirit to the present version, but may differ in detail to address new problems or concerns.

Each version is given a distinguishing version number. If the Library as you received it specifies that a certain numbered version of the GNU Lesser General Public License "or any later version" applies to it, you have the option of following the terms and conditions either of that published version or of any later version

published by the Free Software Foundation. If the Library as you received it does not specify a version number of the GNU Lesser General Public License, you may choose any version of the GNU Lesser General Public License ever published by the Free Software Foundation.

If the Library as you received it specifies that a proxy can decide whether future versions of the GNU Lesser General Public License shall apply, that proxy's public statement of acceptance of any version is permanent authorization for you to choose that version for the Library.

## IJG License

libjpeg-turbo note: This file has been modified by The libjpeg-turbo Project to include only information relevant to libjpeg-turbo, to wordsmith certain sections, and to remove impolitic language that existed in the libjpeg v8 README. It is included only for reference. Please see README.md for information specific to libjpeg-turbo.

The Independent JPEG Group's JPEG software

This distribution contains a release of the Independent JPEG Group's free JPEG software. You are welcome to redistribute this software and to use it for any purpose, subject to the conditions under LEGAL ISSUES, below. This software is the work of Tom Lane, Guido Vollbeding, Philip Gladstone, Bill Allombert, Jim Boucher, Lee Crocker, Bob Friesenhahn, Ben Jackson, Julian Minguillon, Luis Ortiz, George Phillips, Davide Rossi, Ge' Weijers, and other members of the Independent JPEG Group. IJG is not affiliated with the ISO/IEC JTC1/SC29/WG1 standards committee (also known as JPEG, together with ITU-T SG16).

### OVERVIEW

This package contains C software to implement JPEG image encoding, decoding, and transcoding. JPEG (pronounced "jay-peg") is a standardized compression method for full-color and grayscale images. JPEG's strong suit is compressing photographic images or other types of images that have smooth color and brightness transitions between neighboring pixels. Images with sharp lines or other abrupt features may not compress well with JPEG, and a higher JPEG quality may have to be used to avoid visible compression artifacts with such images.

JPEG is normally lossy, meaning that the output pixels are not necessarily identical to the input pixels. However, on photographic content and other "smooth" images, very good compression ratios can be obtained with no visible compression artifacts, and extremely high compression ratios are possible if you are willing to sacrifice image quality (by reducing the "quality" setting in the compressor.) This software implements JPEG baseline, extended-sequential, progressive, and lossless compression processes. Provision is made for supporting all variants of these processes, although some uncommon parameter settings aren't implemented yet. We have made no provision for supporting the hierarchical processes defined in the standard.

We provide a set of library routines for reading and writing JPEG image files, plus two sample applications "cjpeg" and "djpeg", which use the library to perform conversion between JPEG and some other popular image file formats. The library is intended to be reused in other applications. In order to support file conversion and viewing software, we have included considerable functionality beyond the bare JPEG coding/decoding capability; for example, the color quantization modules are not strictly part of JPEG decoding, but they are essential for output to colormapped file formats. These extra functions can be compiled out of the library if not required for a particular application. We have also included "jpegtran", a utility for lossless transcoding between different JPEG processes, and "rdjpgcom" and "wrjpgcom", two simple applications for inserting and extracting textual comments in JFIF files. The emphasis in designing this software has been on achieving portability and flexibility, while also making it fast enough to be useful. In particular, the software is not intended to be read as a tutorial on JPEG. (See the REFERENCES section for introductory material.) Rather, it is intended to be reliable, portable, industrial-strength code. We do not claim to have achieved that goal in every aspect of the software, but we strive for it. We welcome the use of this software as a component of commercial products.

No royalty is required, but we do ask for an acknowledgement in product documentation, as described under LEGAL ISSUES.

### LEGAL ISSUES

=====

In plain English:

1. We don't promise that this software works. (But if you find any bugs, please let us know!)

2. You can use this software for whatever you want. You don't have to pay us.

3. You may not pretend that you wrote this software. If you use it in a program, you must acknowledge somewhere in your documentation that you've used the IJG code.

In legalese:

The authors make NO WARRANTY or representation, either express or implied, with respect to this software, its quality, accuracy, merchantability, or fitness for a particular purpose. This software is provided "AS IS", and you, its user, assume the entire risk as to its quality and accuracy. This software is copyright (C) 1991-2020, Thomas G. Lane, Guido Vollbeding.

All Rights Reserved except as specified below.

Permission is hereby granted to use, copy, modify, and distribute this software (or portions thereof) for any purpose, without fee, subject to these

conditions:

(1) If any part of the source code for this software is distributed, then this README file must be included, with this copyright and no-warranty notice unaltered; and any additions, deletions, or changes to the original files must be clearly indicated in accompanying documentation.

(2) If only executable code is distributed, then the accompanying documentation must state that "this software is based in part on the work of the Independent JPEG Group".

(3) Permission for use of this software is granted only if the user accepts full responsibility for any undesirable consequences; the authors accept NO LIABILITY for damages of any kind.

These conditions apply to any software derived from or based on the IJG code, not just to the unmodified library. If you use our work, you ought to acknowledge us. Permission is NOT granted for the use of any IJG author's name or company name in advertising or publicity relating to this software or products derived from it. This software may be referred to only as "the Independent JPEG Group's software".

We specifically permit and encourage the use of this software as the basis of commercial products, provided that all warranty or liability claims are assumed by the product vendor.

## Mesa3D License (OpenGL)

Copyright (C) 1999-2007 Brian Paul All Rights Reserved.

Permission is hereby granted, free of charge, to any person obtaining a copy of this software and associated documentation files (the "Software"), to deal in the Software without restriction, including without limitation the rights to use, copy, modify, merge, publish, distribute, sublicense, and/or sell copies of the Software, and to permit persons to whom the Software is furnished to do so, subject to the following conditions: The above copyright notice and this permission notice shall be included in all copies or substantial portions of the Software.

THE SOFTWARE IS PROVIDED "AS IS", WITHOUT WARRANTY OF ANY KIND, EXPRESS OR IMPLIED, INCLUDING BUT NOT LIMITED TO THE WARRANTIES OF MERCHANTABILITY, FITNESS FOR A PARTICULAR PURPOSE AND NONINFRINGEMENT. IN NO EVENT SHALL THE AUTHORS OR COPYRIGHT HOLDERS BE LIABLE FOR ANY CLAIM, DAMAGES OR OTHER LIABILITY, WHETHER IN AN ACTION OF CONTRACT, TORT OR OTHERWISE, ARISING FROM, OUT OF OR IN CONNECTION WITH THE SOFTWARE OR THE USE OR OTHER DEALINGS IN THE SOFTWARE.

## Mesa3D Graphics Library License (OpenGL)

Mesa 3-D graphics library

Copyright (C) 1999-2006 Brian Paul All Rights Reserved.  
Copyright (C) 2009 VMware, Inc. All Rights Reserved.

Permission is hereby granted, free of charge, to any person obtaining a copy of this software and associated documentation files (the "Software"), to deal in the Software without restriction, including without limitation the rights to use, copy, modify, merge, publish, distribute, sublicense, and/or sell copies of the Software, and to permit persons to whom the Software is furnished to do so, subject to the following conditions:

The above copyright notice and this permission notice shall be included in all copies or substantial portions of the Software.

THE SOFTWARE IS PROVIDED "AS IS", WITHOUT WARRANTY OF ANY KIND, EXPRESS OR IMPLIED, INCLUDING BUT NOT LIMITED TO THE WARRANTIES OF MERCHANTABILITY, FITNESS FOR A PARTICULAR PURPOSE AND NONINFRINGEMENT. IN NO EVENT SHALL THE AUTHORS OR COPYRIGHT HOLDERS BE LIABLE FOR ANY CLAIM, DAMAGES OR OTHER LIABILITY, WHETHER IN AN ACTION OF CONTRACT, TORT OR OTHERWISE, ARISING FROM, OUT OF OR IN CONNECTION WITH THE SOFTWARE OR THE USE OR OTHER DEALINGS IN THE SOFTWARE.

## MIT License Modern Variant (Fontconfig)

fontconfig/COPYING

Copyright © 2000,2001,2002,2003,2004,2006,2007 Keith Packard

Copyright © 2005 Patrick Lam

Copyright © 2007 Dwayne Bailey and Translate.org.za

Copyright © 2009 Roozbeh Pournader

Copyright © 2008,2009,2010,2011,2012,2013,2014,2015,2016,2017,2018,2019,2020 Red Hat, Inc.

Copyright © 2008 Danilo Šegan

Copyright © 2012 Google, Inc.

Permission to use, copy, modify, distribute, and sell this software and its documentation for any purpose is hereby granted without fee, provided that the above copyright notice appear in all copies and that both that copyright notice and this permission notice appear in supporting documentation, and that the name of the author(s) not be used in advertising or publicity pertaining to distribution of the software without specific, written prior permission. The authors make no representations about the suitability of this software for any purpose. It is provided "as is" without express or implied warranty. THE AUTHOR(S) DISCLAIMS ALL WARRANTIES WITH REGARD TO THIS SOFTWARE, INCLUDING ALL IMPLIED WARRANTIES OF MERCHANTABILITY AND FITNESS, IN NO EVENT SHALL THE AUTHOR(S) BE LIABLE FOR ANY SPECIAL, INDIRECT OR CONSEQUENTIAL DAMAGES OR ANY DAMAGES WHATSOEVER RESULTING FROM LOSS OF USE, DATA OR PROFITS, WHETHER IN AN ACTION OF CONTRACT, NEGLIGENCE OR OTHER TORTIOUS ACTION, ARISING OUT OF OR IN CONNECTION WITH THE USE OR PERFORMANCE OF THIS SOFTWARE.

## MIT License Altered (Freeglut)

### Freeglut Copyright

Freeglut code without an explicit copyright is covered by the following copyright:

Copyright (c) 1999-2000 Pawel W. Olszta. All Rights Reserved. Permission is hereby granted, free of charge, to any person obtaining a copy of this software and associated documentation files (the "Software"), to deal in the Software without restriction, including without limitation the rights to use, copy, modify, merge, publish, distribute, sublicense, and/or sell copies or substantial portions of the Software.

The above copyright notice and this permission notice shall be included in all copies or substantial portions of the Software.

THE SOFTWARE IS PROVIDED "AS IS", WITHOUT WARRANTY OF ANY KIND, EXPRESS OR IMPLIED, INCLUDING BUT NOT LIMITED TO THE WARRANTIES OF MERCHANTABILITY, FITNESS FOR A PARTICULAR PURPOSE AND NONINFRINGEMENT. IN NO EVENT SHALL PAWEL W. OLSZTA BE LIABLE FOR ANY CLAIM, DAMAGES OR OTHER LIABILITY, WHETHER IN AN ACTION OF CONTRACT, TORT OR OTHERWISE, ARISING FROM, OUT OF OR IN CONNECTION WITH THE SOFTWARE OR THE USE OR OTHER DEALINGS IN THE SOFTWARE. Except as contained in this notice, the name of Pawel W. Olszta shall not be used in advertising or otherwise to promote the sale, use or other dealings in this Software without prior written authorization from Pawel W. Olszta.

## MIT License (TouchBar)

MIT License

Copyright (c) 2018 - 2019 thizzer.com

Permission is hereby granted, free of charge, to any person obtaining a copy of this software and associated documentation files (the "Software"), to deal in the Software without restriction, including without limitation the rights to use, copy, modify, merge, publish, distribute, sublicense, and/or sell copies of the Software, and to permit persons to whom the Software is furnished to do so, subject to the following conditions:

The above copyright notice and this permission notice shall be included in all copies or substantial portions of the Software.

THE SOFTWARE IS PROVIDED "AS IS", WITHOUT WARRANTY OF ANY KIND, EXPRESS OR IMPLIED, INCLUDING BUT NOT LIMITED TO THE WARRANTIES OF MERCHANTABILITY, FITNESS FOR A PARTICULAR PURPOSE AND NONINFRINGEMENT. IN NO EVENT SHALL THE AUTHORS OR COPYRIGHT HOLDERS BE LIABLE FOR ANY CLAIM, DAMAGES OR OTHER LIABILITY, WHETHER IN AN ACTION OF CONTRACT, TORT OR OTHERWISE, ARISING FROM, OUT OF OR IN CONNECTION WITH THE SOFTWARE OR THE USE OR OTHER DEALINGS IN THE SOFTWARE.

## MIT License (USB4Java)

Copyright (C) 2011 Klaus Reimer, k@ailis.de

Copyright (C) 2013 Luca Longinotti, l@longi.li

Permission is hereby granted, free of charge, to any person obtaining a copy of this software and associated documentation files (the "Software"), to deal in the Software without restriction, including without limitation the rights to use, copy, modify, merge, publish, distribute, sublicense, and/or sell copies of the Software, and to permit persons to whom the Software is furnished to do so, subject to the following conditions:

The above copyright notice and this permission notice shall be included in all copies or substantial portions of the Software.

THE SOFTWARE IS PROVIDED "AS IS", WITHOUT WARRANTY OF ANY KIND, EXPRESS OR IMPLIED, INCLUDING BUT NOT LIMITED TO THE WARRANTIES OF MERCHANTABILITY, FITNESS FOR A PARTICULAR PURPOSE AND NONINFRINGEMENT. IN NO EVENT SHALL THE AUTHORS OR COPYRIGHT HOLDERS BE LIABLE FOR ANY CLAIM, DAMAGES OR OTHER LIABILITY, WHETHER IN AN ACTION OF CONTRACT, TORT OR OTHERWISE, ARISING FROM, OUT OF OR IN CONNECTION WITH THE SOFTWARE OR THE USE OR OTHER DEALINGS IN THE SOFTWARE.

## Modified Apache License 1.1 (Jdom)

Copyright (C) 2000-2012 Jason Hunter & Brett McLaughlin.

All rights reserved.

Redistribution and use in source and binary forms, with or without modification, are permitted provided that the following conditions are met:

1. Redistributions of source code must retain the above copyright notice, this list of conditions, and the following disclaimer.
2. Redistributions in binary form must reproduce the above copyright notice, this list of conditions, and the disclaimer that follows these conditions in the documentation and/or other materials provided with the distribution.
3. The name "JDOM" must not be used to endorse or promote products derived from this software without prior written permission. For written permission, please contact <request\_AT\_jdom\_DOT\_org>.
4. Products derived from this software may not be called "JDOM", nor may "JDOM" appear in their name, without prior written permission from the JDOM Project Management <request\_AT\_jdom\_DOT\_org>.

In addition, we request (but do not require) that you include in the end-user documentation provided with the redistribution and/or in the software itself an acknowledgement equivalent to the following:

"This product includes software developed by the JDOM Project (<http://www.jdom.org/>)."

Alternatively, the acknowledgment may be graphical using the logos available at <http://www.jdom.org/images/logos>.

THIS SOFTWARE IS PROVIDED ``AS IS'' AND ANY EXPRESSED OR IMPLIED WARRANTIES, INCLUDING, BUT NOT LIMITED TO, THE IMPLIED WARRANTIES OF MERCHANTABILITY AND FITNESS FOR A PARTICULAR PURPOSE ARE DISCLAIMED. IN NO EVENT SHALL THE JDOM AUTHORS OR THE PROJECT CONTRIBUTORS BE LIABLE FOR ANY DIRECT, INDIRECT, INCIDENTAL, SPECIAL, EXEMPLARY, OR CONSEQUENTIAL DAMAGES (INCLUDING, BUT NOT LIMITED TO, PROCUREMENT OF SUBSTITUTE GOODS OR SERVICES; LOSS OF USE, DATA, OR PROFITS; OR BUSINESS INTERRUPTION) HOWEVER CAUSED AND ON ANY THEORY OF LIABILITY, WHETHER IN CONTRACT, STRICT LIABILITY, OR TORT (INCLUDING NEGLIGENCE OR OTHERWISE) ARISING IN ANY WAY OUT OF THE USE OF THIS SOFTWARE, EVEN IF ADVISED OF THE POSSIBILITY OF SUCH DAMAGE.

This software consists of voluntary contributions made by many individuals on behalf of the JDOM Project and was originally created by Jason Hunter <jhunter\_AT\_jdom\_DOT\_org> and Brett McLaughlin <brett\_AT\_jdom\_DOT\_org>. For more information on the JDOM Project, please see <<http://www.jdom.org/>>.

# NDI License

## NDI Software Development Kit (SDK) License Agreement

Please read this document carefully before proceeding. You (the undersigned Licensee) hereby agree to the terms of this NDI® Software Development Kit (SDK) License Agreement (the "License") in order to use the SDK. Vizrt NDI AB ("NDI") agrees to license you certain rights as set forth herein under these terms.

### 1. Definitions

- a. "SDK" means the entire NDI® Software Development Kit, including those portions pertaining to the Specific SDK, provided to you pursuant to this License, including any source code, compiled executables or libraries, and all documentation provided to you to assist you in building Products (as defined below) that use the NDI® Software for data transfer over a local network.
- b. "Products" means your software product(s) and/or service(s) that you develop or that are developed on your behalf through the use of the SDK, which run on general purpose operating systems installed on general purpose computing platforms such as servers, desktops, laptops, and mobile devices on which the end user can freely change or update the operating system, and/or install, run and upgrade third party software applications, and that are designed to be, and/or are, used, sold and/or distributed to work closely with other NDI Products or Third Party

Video Products. "Products" expressly excludes:

- i) any hardware product(s) or product(s) sold as hardware;
  - ii) any fixed-purpose "appliances(s)" or similar electronic device(s) or embodiment(s) that is/are designed, marketed, or intended to prevent or restrict the end user from modifying the installed operating system or installing third-party software applications beyond the limited methods provided by the manufacturer's intended use; and
  - iii) any product(s) built using hardware that may be categorized as an embedded device, and utilizing an operating system typically used for embedded devices, which includes, but is not limited to Windows IoT, Android, Linux, Linux derivatives, or any similar operating system. This includes products integrating hardware and software with a specific function that cannot easily be changed to perform significantly different functions from its intended purpose at the time of sale.
- c. "NDI Products" refers to NDI's line of products distributed by NDI and any upgrades.
  - d. "SDK Documentation" refers to the documentation included with the Software Development Kit including that portion pertaining to the Specific SDK.
  - e. "Specific SDK" refers to the specific SDK for which you intend to use the NDI® SDK and this license (for example: NDI® Send, NDI Receive, NDI Find, or other SDK's that are available from time to time. These are examples only and NDI may add or subtract to this list at its discretion, and you agree to use them only in accordance with this Agreement), and includes the documentation relating to it.
  - f. "Third Party Video Products" refers to products of third parties developed by or for them also using the NDI® Software Development Kit in any way.

### 2. License

- a. Pursuant to the terms, conditions and requirements of this License and the SDK Documentation, you are hereby granted a nonexclusive royalty-free license to use the sample code, object code and documentation included in the SDK for the sole purpose of developing Products using the Specific SDK, and to distribute, only in accordance with the SDK Documentation requirements, object code included in the SDK solely as used by such Products (your Product and compiled sample code referred to as the "Bundled Product").
- b. If you are making a product release you must use a version of the SDK that is less than thirty (30) days old if there is one.

c. This is a License only, and no employment, joint venture, partnership, or other business venture is created by this License.

d. Unless otherwise stated in the SDK, no files within the SDK and the Specific SDK may be distributed. Certain files within the SDK or the Specific SDK may be distributed, said files and their respective distribution license are individually identified within the SDK documentation. This is not a license to create revisions or other derivative works of any NDI software or technology.

e. You agree to comply with the steps outlined in the SDK Documentation, including the SDK manual for the Specific SDK. Different obligations and restrictions may be imposed by NDI with respect to different Specific SDK's. NDI will April 2023 NDI® Technology License Agreement not agree to sponsor your Product or show affiliation; however NDI shall have the right to test the Product, and if it does not work or operate to NDI's satisfaction, NDI may terminate this license pursuant to Section 10. Notwithstanding that NDI may test the Product, it does not warrant the test; it is for NDI's benefit, and you agree not to promote in your Product marketing or elsewhere any results or that NDI has tested the Product.

f. You acknowledge that information provided to NDI to induce NDI to enter into this license with you about your experience in the industry, sales, distribution, SDK experience or otherwise, whether such information is provided to NDI verbally or in writing, is true.

g. NDI makes the SDK available for developers for developing Products only, under these specific conditions herein, and if any, or all, of the terms of this license are not enforceable within your legal jurisdiction in any way, or if any clause is voided or modified in any way, then you may not enter into this agreement, any license and permission granted herein is revoked and withdrawn as of the date you first downloaded and/or used the SDK, and you are then unauthorized to copy, create derivative works, or otherwise use the SDK in any way.

### 3. Restrictions and Confidentiality.

a. "Confidential Information" includes the SDK and all specifications, source code, example code, tools and documentation provided within the SDK, and any support thereof, and any other proprietary information provided by NDI and identified as Confidential in the course of assisting You with your NDI® implementation. Confidential Information does not include information that: 1) is or becomes generally available to the public other than as a result of a disclosure by You, or 2) becomes available to You on a non-confidential basis from a source that was not prohibited from disclosing such information. Except as authorized herein, or in the SDK Documentation, or as otherwise approved in writing by NDI: 1) The disclosure to you of the SDK and all other Confidential Information shall not be disclosed to any third party 2) You agree not to commercialize the Confidential Information for yours or others benefit in any way; 3) You will not make or distribute copies of the SDK, or other Confidential Information or electronically transfer the SDK to any individual within your business or company who does not need to know or view the SDK, and under no circumstances shall you disclose it, or any part of it, to any company, or any other individual not employed directly by the business or company you represent, without express written permission of NDI.

b. You will not modify, sell, rent, transfer, resell for profit, distribute, or create derivative works based upon the SDK or any part thereof other than as set forth herein, and you will not allow independent contractors to create derivative works; however, you may use the SDK to create your own program for the primary purpose of making it or your Product compatible with the NDI network APIs, a NDI Product, or for other purposes expressly set forth by you in advance in writing and agreed to in writing by NDI. In the case of your derivative works based upon the SDK, you may create and revise your Product using the SDK, and sell, rent, transfer, resell for profit and distribute, so long as it is for the Principal objective for which you were provided the SDK and it otherwise complies with this agreement, including the requirement that your Product or any other Third Party Product using any portion of the SDK continues to use the current SDK as required herein and functions properly using the SDK. NDI reserves the right to determine at any time the compliance of your Product or any Third Party Product as properly using the SDK including maintaining current and complete NDI compatibility. Notwithstanding anything to the contrary herein, no intellectual property claim, whether in patent, trademark, copyright, or otherwise, is made by NDI in or to your Product (except as to the SDK including software code and/or Libraries, and copyright rights therein, and any Confidential Information used in or with the Product).

c. You will comply with applicable export control and trade sanctions laws, rules, regulations and licenses and will not export or re-export, directly or indirectly, the SDK into any country, to any organization or individual prohibited by the United States Export Administration Act and the regulations thereunder.

d. Any direct or indirect distribution of your Product or any Bundled Products by you that include your Product, shall be under the terms of a license agreement containing terms that: (i) prohibit any modifications to the SDK or any part thereof, (ii) prohibit any reverse engineering, disassembly or recompilation of the SDK or any part thereof, or any protocols used in the SDK, and further prohibit any attempt to do so; (iii) disclaim any and all warranties on behalf of NDI and each of its licensors, (iv) disclaim, to the extent permitted by applicable law, liability of NDI and/or its licensors for any damages, whether direct, indirect, incidental or consequential, arising from the use of the Product or Bundled Products, (v) comply fully with all relevant export laws and regulations of the United States to assure that the Bundled Products or any part thereof is not exported, directly or indirectly, in violation of United States law; (vi) include the appropriate copyright notice showing NDI, Inc. as copyright owner; (vii) require all third April 2023 NDI® Technology License Agreement party developers using your Product to develop Third Party Products to comply with the terms of the NDI® SDK license, including that such Third Party Products have current and complete NDI compatibility, and further require such third party developers to include in their End User License Agreement the terms of this paragraph 3d.

e. You agree not to use the SDK for any unlawful purpose or in any way to cause injury, harm or damage to NDI, or its Products, trademarks, reputation and/or goodwill, or use information provided pursuant to the SDK, to interfere with NDI in the commercialization of NDI Products.

f. You agree to use NDI trademarks (NDI trademarks include, but are not limited to NDI®, NDIHX™), only in accordance with applicable policies of NDI for such trademark usage by software developers in effect from time to time, which policy may be amended at any time with or without notice. NDI's trademarks shall not be utilized within the Product itself, or on the Product packaging or promotion, or on websites, except to identify that the Product is compatible with NDI Products, and in all cases where NDI trademarks are utilized, special and clear notations shall be provided that the marks are NDI trademarks. Your Product is not a product of NDI and no promotion, packaging, or use of NDI trademarks shall suggest sponsorship by NDI of your Products, except where specifically authorized by NDI in writing. Any distribution of your Product in a fraudulent manner, or in any other manner or method that violates any civil or criminal laws shall constitute a default under this agreement and result in immediate revocation of any right to utilize NDI's marks.

g. NDI owns or has licensed copyright rights to the SDK. To the extent any of the SDK is incorporated into your Product, you agree to include all applicable copyright notices, along with yours, indicating NDI's copyright rights as applicable and as requested by NDI.

h. You agree that by using the SDK, or any portion or part of the NDI® Software, in your Products, that you shall not at any time during the term create, use or distribute Products utilizing the NDI® SDK that are not interoperable with, or have significantly degraded performance of functionality when working with, NDI Products or Third Party Video Products that are created with or utilize in whole or in part the SDK. Your Products and Third Party Products must maintain current and complete NDI® compatibility at all times.

i. You agree to not to reverse engineer, disassemble or recompile the SDK or any part thereof, or any protocols used in the SDK, or attempt to do so.

j. You agree not to use the SDK, or cause the SDK to be used, for any purpose that it was not designed for, and in particular, you agree not to use the SDK for any purpose but for the precise purposes as expressly identified to NDI in writing that is the basis of the SDK and this license, and you agree you will not attempt to violate any of the foregoing, or encourage third parties to do so.

4. Software Defect Reporting If you find software defects in the SDK, you agree to make reasonable effort to report them to NDI in accordance with the SDK documentation or in such other manner as NDI directs in writing. NDI will evaluate and, at its sole discretion, may address them in a future revision of the SDK. NDI does not warrant the SDK to be free of defects.

## 5. Updates

You understand and agree that NDI may amend, modify, change, and/or cease distribution or production of the SDK at any time. You understand that you are not entitled to receive any upgrades, updates, or future versions of the SDK under this License. NDI does not warrant or represent that its future updates and revisions will be compatible with your Product, and NDI does not warrant that its updates and/or revisions will allow your Product to be compatible with or without modifications to your Product.

## 6. Ownership

Nothing herein is intended to convey to you any patent, trademark, copyright, trade secret or other Intellectual Property owned by NDI or its Licensors in the SDK or in any NDI software, hardware, products, trade names, or trademarks. NDI and its suppliers or licensors shall retain all right, title, and interest to the foregoing Intellectual Property and to the SDK. All rights not expressly granted herein are reserved by NDI.

## 7. Indemnity and Limitations

You agree to indemnify and hold NDI harmless from any third party claim, loss, or damage (including attorney's fees) related to your use, sale or distribution of the SDK. THE SDK IS PROVIDED TO YOU FREE OF CHARGE, AND ON AN "AS IS" BASIS AND "WITH ALL FAULTS", WITHOUT ANY TECHNICAL SUPPORT OR WARRANTY OF ANY KIND FROM NDI. YOU ASSUME ALL RISKS THAT THE SDK IS SUITABLE OR ACCURATE FOR YOUR NEEDS AND YOUR USE OF THE SDK IS April 2023 NDI® Technology License Agreement

AT YOUR OWN DISCRETION AND RISK. NDI AND ITS LICENSORS DISCLAIM ALL EXPRESS AND IMPLIED WARRANTIES FOR THE SDK INCLUDING, WITHOUT LIMITATION, ANY WARRANTY OF MERCHANTABILITY OR FITNESS FOR A PARTICULAR PURPOSE. ALSO, THERE IS NO WARRANTY OF NON-INFRINGEMENT, TITLE OR QUIET ENJOYMENT. SOME STATES DO NOT ALLOW THE EXCLUSION OF IMPLIED WARRANTIES, SO THE ABOVE EXCLUSION MAY NOT APPLY TO YOU. YOU MAY ALSO HAVE OTHER LEGAL RIGHTS THAT VARY FROM STATE TO STATE.

## 8. Limitation of Damages

NEITHER NDI NOR ITS SUPPLIERS OR LICENSORS SHALL BE LIABLE FOR ANY INDIRECT, SPECIAL, INCIDENTAL OR CONSEQUENTIAL DAMAGES OR LOSS (INCLUDING DAMAGES FOR LOSS OF BUSINESS, LOSS OF PROFITS, OR THE LIKE), ARISING OUT OF THIS LICENSE WHETHER BASED ON BREACH OF CONTRACT, TORT (INCLUDING NEGLIGENCE), STRICT LIABILITY, PRODUCT LIABILITY OR OTHERWISE, EVEN IF NDI OR ITS REPRESENTATIVES HAVE BEEN ADVISED OF THE POSSIBILITY OF SUCH DAMAGES. SOME STATES DO NOT ALLOW THE LIMITATION OR EXCLUSION OF LIABILITY FOR INCIDENTAL OR CONSEQUENTIAL DAMAGES, SO THIS LIMITATION OR EXCLUSION MAY NOT APPLY TO YOU. The limited warranty, exclusive remedies and limited liability set forth above are fundamental elements of the basis of the bargain between NDI and you. You agree that NDI would not be able to provide the Software on an economic basis without such limitations. IN NO EVENT WILL NDI BE LIABLE FOR ANY AMOUNT GREATER THAN WHAT YOU ACTUALLY PAID FOR THE SDK.

## 9. Termination

Either party may terminate this License upon thirty (30) days written notice. Either party may also terminate if the other party materially defaults in the performance of any provision of this License, the non-defaulting party gives written notice to the other party of such default, and the defaulting party fails to cure such default within ten (10) days after receipt of such notice. Upon the termination of this License, the rights and licenses granted to you by NDI pursuant to this License will automatically cease. Nothing herein shall prevent either party from pursuing any injunctive relief at any time if necessary, or seeking any other remedies available in equity. Each party reserves the right to pursue all legal and equitable remedies available. Upon termination, all SDK materials shall be promptly returned to NDI, and any and all copies stored in electronic or other format shall be deleted and destroyed, and any rights to use NDI's trademarks are revoked. If this License is terminated for any reason, the provisions of Sections 1, 3, 6, 7, 8, 9, 10, and 11 shall survive such termination.

## 10. General

Notices given hereunder may be sent to either party at the address below by either overnight mail or by email and are deemed effective when sent. This License shall be governed by the laws of Sweden, without regard to its choice of law rules and you agree to exclusive jurisdiction therein. This License contains the

complete agreement between you and NDI with respect to the subject matter (SDK) of this License, and supersedes all prior or contemporaneous agreements or understandings, whether oral or written. It does not replace any licenses accompanying NDI Products. You may not assign this SDK License.

# SGI Free Software B 2.0 License (OpenGL)

SGI Free Software License B v2.0

Full name

SGI Free Software License B v2.0

Short identifier

SGI-B-2.0

Other web pages for this license

<http://oss.sgi.com/projects/FreeB/SGIFreeSWLicB.2.0.pdf> [no longer live]

Notes

This license was released 18 Sept 2008

Text

SGI FREE SOFTWARE LICENSE B

(Version 2.0, Sept. 18, 2008)

Copyright (C) [dates of first publication] Silicon Graphics, Inc. All Rights Reserved.

Permission is hereby granted, free of charge, to any person obtaining a copy of this software and associated documentation files (the "Software"), to deal in the Software without restriction, including without limitation the rights to use, copy, modify, merge, publish, distribute, sublicense, and/or sell copies of the Software, and to permit persons to whom the Software is furnished to do so, subject to the following conditions:

The above copyright notice including the dates of first publication and either this permission notice or a reference to <http://oss.sgi.com/projects/FreeB/> shall be included in all copies or substantial portions of the Software.

THE SOFTWARE IS PROVIDED "AS IS", WITHOUT WARRANTY OF ANY KIND, EXPRESS OR IMPLIED, INCLUDING BUT NOT LIMITED TO THE WARRANTIES OF MERCHANTABILITY, FITNESS FOR A PARTICULAR PURPOSE AND NONINFRINGEMENT. IN NO EVENT SHALL SILICON GRAPHICS, INC. BE LIABLE FOR ANY CLAIM, DAMAGES OR OTHER LIABILITY, WHETHER IN AN ACTION OF CONTRACT, TORT OR OTHERWISE, ARISING FROM, OUT OF OR IN CONNECTION WITH THE SOFTWARE OR THE USE OR OTHER DEALINGS IN THE SOFTWARE.

Except as contained in this notice, the name of Silicon Graphics, Inc. shall not be used in advertising or otherwise to promote the sale, use or other dealings in this Software without prior written authorization from Silicon Graphics, Inc.

# SIL Open Font License 1.1 (Font-Awesome)

Fonticons, Inc. (<https://fontawesome.com>)

Font Awesome Free License

Font Awesome Free is free, open source, and GPL friendly. You can use it for commercial projects, open source projects, or really almost whatever you want.

Full Font Awesome Free license: <https://fontawesome.com/license/free>.

# Icons: CC BY 4.0 License (<https://creativecommons.org/licenses/by/4.0/>)

The Font Awesome Free download is licensed under a Creative Commons Attribution 4.0 International License and applies to all icons packaged as SVG and JS file types.

# Fonts: SIL OFL 1.1 License

In the Font Awesome Free download, the SIL OFL license applies to all icons packaged as web and desktop font files.

Copyright (c) 2024 Fonticons, Inc. (<https://fontawesome.com>) with Reserved Font Name: "Font Awesome". This Font Software is licensed under the SIL Open Font License, Version 1.1. This license is copied below, and is also available with a FAQ at: <http://scripts.sil.org/OFL>

## SIL OPEN FONT LICENSE

Version 1.1 - 26 February 2007

### PREAMBLE

The goals of the Open Font License (OFL) are to stimulate worldwide development of collaborative font projects, to support the font creation efforts of academic and linguistic communities, and to provide a free and open framework in which fonts may be shared and improved in partnership with others. The OFL allows the licensed fonts to be used, studied, modified and redistributed freely as long as they are not sold by themselves. The fonts, including any derivative works, can be bundled, embedded, redistributed and/or sold with any software provided that any reserved names are not used by derivative works. The fonts and derivatives, however, cannot be released under any other type of license. The requirement for fonts to remain under this license does not apply to any document created using the fonts or their derivatives.

### DEFINITIONS

"Font Software" refers to the set of files released by the Copyright Holder(s) under this license and clearly marked as such. This may include source files, build scripts and documentation.

"Reserved Font Name" refers to any names specified as such after the copyright statement(s). "Original Version" refers to the collection of Font Software components as distributed by the Copyright Holder(s).

"Modified Version" refers to any derivative made by adding to, deleting, or substituting — in part or in whole — any of the components of the Original Version, by changing formats or by porting the Font Software to a new environment.

"Author" refers to any designer, engineer, programmer, technical writer or other person who contributed to the Font Software.

### PERMISSION & CONDITIONS

Permission is hereby granted, free of charge, to any person obtaining a copy of the Font Software, to use, study, copy, merge, embed, modify,

redistribute, and sell modified and unmodified copies of the Font

Software, subject to the following conditions:

- 1) Neither the Font Software nor any of its individual components, in Original or Modified Versions, may be sold by itself.
- 2) Original or Modified Versions of the Font Software may be bundled, redistributed and/or sold with any software, provided that each copy contains the above copyright notice and this license. These can be included either as stand-alone text files, human-readable headers or in the appropriate machine-readable metadata fields within text or binary files as long as those fields can be easily viewed by the user.
- 3) No Modified Version of the Font Software may use the Reserved Font Name(s) unless explicit written permission is granted by the corresponding Copyright Holder. This restriction only applies to the primary font name as presented to the users.
- 4) The name(s) of the Copyright Holder(s) or the Author(s) of the Font Software shall not be used to promote, endorse or advertise any Modified Version, except to acknowledge the contribution(s) of the Copyright Holder(s) and the Author(s) or with their explicit written permission.
- 5) The Font Software, modified or unmodified, in part or in whole, must be distributed entirely under this license, and must not be distributed under any other license. The requirement for fonts to remain under this license does not apply to any document created using the Font Software.

#### TERMINATION

This license becomes null and void if any of the above conditions are not met.

#### DISCLAIMER

THE FONT SOFTWARE IS PROVIDED "AS IS", WITHOUT WARRANTY OF ANY KIND, EXPRESS OR IMPLIED, INCLUDING BUT NOT LIMITED TO ANY WARRANTIES OF MERCHANTABILITY, FITNESS FOR A PARTICULAR PURPOSE AND NONINFRINGEMENT OF COPYRIGHT, PATENT, TRADEMARK, OR OTHER RIGHT. IN NO EVENT SHALL THE COPYRIGHT HOLDER BE LIABLE FOR ANY CLAIM, DAMAGES OR OTHER LIABILITY, INCLUDING ANY GENERAL, SPECIAL, INDIRECT, INCIDENTAL, OR CONSEQUENTIAL DAMAGES, WHETHER IN AN ACTION OF CONTRACT, TORT OR OTHERWISE, ARISING

FROM, OUT OF THE USE OR INABILITY TO USE THE FONT SOFTWARE OR FROM OTHER DEALINGS IN THE FONT SOFTWARE.

# Code: MIT License (<https://opensource.org/licenses/MIT>) In the Font Awesome Free download, the MIT license applies to all non-font and

non-icon files. Copyright 2024 Fonticons, Inc.

Permission is hereby granted, free of charge, to any person obtaining a copy of this software and associated documentation files (the "Software"), to deal in the Software without restriction, including without limitation the rights to use, copy, modify, merge, publish, distribute, sublicense, and/or sell copies of the Software, and to permit persons to whom the Software is furnished to do so, subject to the following conditions:

The above copyright notice and this permission notice shall be included in all copies or substantial portions of the Software.

THE SOFTWARE IS PROVIDED "AS IS", WITHOUT WARRANTY OF ANY KIND, EXPRESS OR IMPLIED, INCLUDING BUT NOT LIMITED TO THE WARRANTIES OF MERCHANTABILITY, FITNESS FOR A PARTICULAR PURPOSE AND NONINFRINGEMENT. IN NO EVENT SHALL THE AUTHORS OR COPYRIGHT HOLDERS BE LIABLE FOR ANY CLAIM, DAMAGES OR OTHER LIABILITY, WHETHER IN AN ACTION OF CONTRACT, TORT OR OTHERWISE, ARISING FROM, OUT OF OR IN CONNECTION WITH THE SOFTWARE OR THE USE OR OTHER DEALINGS IN THE SOFTWARE.

# Attribution

Attribution is required by MIT, SIL OFL, and CC BY licenses. Downloaded Font Awesome Free files already contain embedded comments with sufficient attribution, so you shouldn't need to do anything additional when using these files normally. We've kept attribution comments terse, so we ask that you do not actively work to remove them from files, especially code. They're a great way for folks to learn about Font Awesome.

## # Brand Icons

All brand icons are trademarks of their respective owners. The use of these trademarks does not indicate endorsement of the trademark holder by Font Awesome, nor vice versa. **\*\*Please do not use brand logos for any purpose except to represent the company, product, or service to which they refer.\*\***

# SIL Open Font License 1.1 (OpenSans)

Copyright 2020 The Open Sans Project Authors (<https://github.com/googlefonts/opensans>)

SIL OPEN FONT LICENSE Version 1.1 - 26 February 2007

## PREAMBLE

The goals of the Open Font License (OFL) are to stimulate worldwide development of collaborative font projects, to support the font creation efforts of academic and linguistic communities, and to provide a free and open framework in which fonts may be shared and improved in partnership with others.

The OFL allows the licensed fonts to be used, studied, modified and redistributed freely as long as they are not sold by themselves. The fonts, including any derivative works, can be bundled, embedded, redistributed and/or sold with any software provided that any reserved names are not used by derivative works. The fonts and derivatives, however, cannot be released under any other type of license. The requirement for fonts to remain under this license does not apply to any document created using the fonts or their derivatives.

## DEFINITIONS

"Font Software" refers to the set of files released by the Copyright Holder(s) under this license and clearly marked as such. This may include source files, build scripts and documentation.

"Reserved Font Name" refers to any names specified as such after the copyright statement(s).

"Original Version" refers to the collection of Font Software components as distributed by the Copyright Holder(s).

"Modified Version" refers to any derivative made by adding to, deleting, or substituting -- in part or in whole -- any of the components of the Original Version, by changing formats or by porting the Font Software to a new environment.

"Author" refers to any designer, engineer, programmer, technical writer or other person who contributed to the Font Software.

## PERMISSION & CONDITIONS

Permission is hereby granted, free of charge, to any person obtaining a copy of the Font Software, to use, study, copy, merge, embed, modify, redistribute, and sell modified and unmodified copies of the Font Software, subject to the following conditions:

- 1) Neither the Font Software nor any of its individual components, in Original or Modified Versions, may be sold by itself.
- 2) Original or Modified Versions of the Font Software may be bundled, redistributed and/or sold with any software, provided that each copy contains the above copyright notice and this license. These can be included either as stand-alone text files, human-readable headers or in the appropriate machine-readable metadata fields within text or binary files as long as those fields can be easily viewed by the user.
- 3) No Modified Version of the Font Software may use the Reserved Font Name(s) unless explicit written permission is granted by the corresponding Copyright Holder. This restriction only applies to the primary font name as presented to the users.
- 4) The name(s) of the Copyright Holder(s) or the Author(s) of the Font Software shall not be used to promote, endorse or advertise any Modified Version, except to acknowledge the contribution(s) of the Copyright Holder(s) and the Author(s) or with their explicit written permission.
- 5) The Font Software, modified or unmodified, in part or in whole, must be distributed entirely under this license, and must not be distributed under any other license. The requirement for fonts to remain under this license does not apply to any document created using the Font Software.

## TERMINATION

This license becomes null and void if any of the above conditions are not met.

## DISCLAIMER

THE FONT SOFTWARE IS PROVIDED "AS IS", WITHOUT WARRANTY OF ANY KIND, EXPRESS OR IMPLIED, INCLUDING BUT NOT LIMITED TO ANY WARRANTIES OF MERCHANTABILITY, FITNESS FOR A PARTICULAR PURPOSE AND NONINFRINGEMENT OF COPYRIGHT, PATENT, TRADEMARK, OR OTHER RIGHT. IN NO EVENT SHALL THE COPYRIGHT HOLDER BE LIABLE FOR ANY CLAIM, DAMAGES OR OTHER LIABILITY, INCLUDING ANY GENERAL, SPECIAL, INDIRECT, INCIDENTAL, OR CONSEQUENTIAL DAMAGES, WHETHER IN AN ACTION OF CONTRACT, TORT OR OTHERWISE, ARISING FROM, OUT OF THE USE OR INABILITY TO USE THE FONT SOFTWARE OR FROM OTHER DEALINGS IN THE FONT SOFTWARE.



## Contact Us

Contact our friendly and professional support representatives for the following:

- Name and address of your local dealer
- Product information and pricing
- Technical support
- Upcoming trade show information

<b>Technical Support</b>	<b>Telephone:</b>	+1-844-652-0645 (North America) +800 3540 3545 (International)
	<b>After Hours Emergency:</b>	+1 613 • 349 • 0006
	<b>Email:</b>	techsupport@rossvideo.com

<b>General Information</b>	<b>Telephone:</b>	+1 613 • 652 • 4886
	<b>Fax:</b>	+1 613 • 652 • 4425
	<b>Email:</b>	solutions@rossvideo.com
	<b>Website:</b>	<a href="http://www.rossvideo.com">http://www.rossvideo.com</a>

## Visit Us

Visit our website for:

- Company information and news
- Related products and full product lines
- Online catalog
- Testimonials

