

# PIERO

## PIERO Tech Guide

VERSION 07

**ROSS**

# Thank You for Choosing Ross

You've made a great choice. We expect you will be very happy with your purchase of Ross Technology.

Our mission is to:

1. Provide a Superior Customer Experience
  - offer the best product quality and support
2. Make Cool Practical Technology
  - develop great products that customers love

Ross has become well known for the Ross Video Code of Ethics. It guides our interactions and empowers our employees. I hope you enjoy reading it below.

If anything at all with your Ross experience does not live up to your expectations be sure to reach out to us at [solutions@rossvideo.com](mailto:solutions@rossvideo.com).



David Ross

CEO, Ross Video

[dross@rossvideo.com](mailto:dross@rossvideo.com)

## Ross Video Code of Ethics

Any company is the sum total of the people that make things happen. At Ross, our employees are a special group. Our employees truly care about doing a great job and delivering a high quality customer experience every day. This code of ethics hangs on the wall of all Ross Video locations to guide our behavior:

1. We will always act in our customers' best interest.
2. We will do our best to understand our customers' requirements.
3. We will not ship crap.
4. We will be great to work with.
5. We will do something extra for our customers, as an apology, when something big goes wrong and it's our fault.
6. We will keep our promises.
7. We will treat the competition with respect.
8. We will cooperate with and help other friendly companies.
9. We will go above and beyond in times of crisis. *If there's no one to authorize the required action in times of company or customer crisis - do what you know in your heart is right. (You may rent helicopters if necessary.)*

# PIERO Tech Guide

- Ross Part Number: 3400DR-002-07
- Version: 07

The information contained in this guide is subject to change without notice or obligation.

## Copyright

©2025 Ross Video Limited, Ross®, and any related marks are trademarks or registered trademarks of Ross Video Limited. All other trademarks are the property of their respective companies. PATENTS ISSUED and PENDING. All rights reserved. No part of this publication may be reproduced, stored in a retrieval system, or transmitted in any form or by any means, mechanical, photocopying, recording or otherwise, without the prior written permission of Ross Video. While every precaution has been taken in the preparation of this document, Ross Video assumes no responsibility for errors or omissions. Neither is any liability assumed for damages resulting from the use of the information contained herein.

## Patents

Patent numbers US 7,034,886; US 7,508,455; US 7,602,446; US 7,802,802 B2; US 7,834,886; US 7,914,332; US 8,307,284; US 8,407,374 B2; US 8,499,019 B2; US 8,519,949 B2; US 8,743,292 B2; GB 2,419,119 B; GB 2,447,380 B; and other patents pending.

## Notice

The material in this manual is furnished for informational use only. It is subject to change without notice and should not be construed as commitment by Ross Video Limited. Ross Video Limited assumes no responsibility or liability for errors or inaccuracies that may appear in this manual.

# End User Software License Agreement

This End User Software License Agreement is a legal agreement between you (the "Licensee") and Ross Video Limited ("Ross Video") specifying the terms and conditions of your installation and use of the Software and all Documentation (as those terms are defined herein).

## IMPORTANT:

**BY DOWNLOADING, ACCESSING, INSTALLING OR USING THE SOFTWARE AND/OR DOCUMENTATION AND/OR BY AUTHORIZING ANY THIRD PARTY, INCLUDING WITHOUT LIMITATION AN INSTALLER OR COMMISSIONER ACTING ON YOUR BEHALF TO DO SO, LICENSEE AGREES TO THE TERMS OF THIS AGREEMENT AND THE LICENSE GRANTED HEREUNDER SHALL BE EFFECTIVE AS OF AND FROM SUCH DATE. IF YOU DO NOT WISH TO ACCEPT THE TERMS AND CONDITIONS OF THIS AGREEMENT, DO NOT DOWNLOAD, ACCESS, INSTALL, REFER TO OR OTHERWISE USE THE SOFTWARE AND/OR DOCUMENTATION.**

1. **INTERPRETATION.** In this Agreement, (a) words signifying the singular number include the plural and vice versa, and words signifying gender include all genders; (b) every use of the words "herein", "hereof", "hereto" "hereunder" and similar words shall be construed to refer to this Agreement in its entirety and not to any particular provision hereof; (c) reference to any agreement or other document herein will be construed as referring to such agreement or other document as from time to time amended, modified or supplemented (subject to any restrictions on such amendment, modification or supplement set forth therein); (d) every use of the words "including" or "includes" is to be construed as meaning "including, without limitation" or "includes, without limitation", respectively; and (e) references to an Article or a Section are to be construed as references to an Article or Section of or to this Agreement unless otherwise specified.
2. **DEFINITIONS.** In this Agreement, in addition to the terms defined elsewhere in this Agreement, the following terms have the meanings set out below:

"**Affiliate**" means, with respect to any Person, any other Person who directly or indirectly controls, is controlled by, or is under direct or indirect common control with, such Person. A Person shall be deemed to control a Person if such Person possesses, directly or indirectly, the power to direct or cause the direction of the management and policies of such Person, whether through the ownership of voting securities, by contract or otherwise; and the term "controlled" and "controlling" shall have a similar meaning.

"**Agreement**" means this End User Software License Agreement including the recitals hereto, as the same may be amended from time to time in accordance with the provisions hereof.

"**Backup System**" means the secondary piece of Designated Equipment upon which the Software is installed and mirrored for the sole purpose of replacing a Primary System in the event such Primary System is not available or functioning properly for any reason.

"**Change of Control**" means (a) the direct or indirect sale, transfer or exchange by the shareholders of a Party of more than fifty percent (50%) of the voting securities of such Party, (b) a merger or amalgamation or reorganization or other transaction to which a Party is party after which the shareholders of such Party immediately prior to such transaction hold less than fifty percent (50%) of the voting securities of the surviving entity, (c) the sale, exchange, or transfer of all or substantially all of the assets of a Party.

**"Confidential Information"** means all data and information relating to the business and management of either Party, including the Software, trade secrets and other technology to which access is obtained or granted hereunder by the other Party, and any materials provided by Ross Video to Licensee; provided, however, that Confidential Information shall not include any data or information which:

- (i) is or becomes publicly available through no fault of the other Party;
- (ii) is already in the rightful possession of the other Party prior to its receipt from the other Party;
- (iii) is already known to the receiving Party at the time of its disclosure to the receiving Party by the disclosing Party and is not the subject of an obligation of confidence of any kind;
- (iv) is independently developed by the other Party;
- (v) is rightfully obtained by the other Party from a third party; or
- (vi) is disclosed with the written consent of the Party whose information it is.

**"Designated Equipment"** shall mean (a) the hardware products sold by Ross Video to Licensee on which the Software is installed and licensed for use, as the same may be replaced from time to time by Ross Video; or (b) in the case of Software licensed on a stand-alone basis, the equipment of Licensee on which the Software is to be installed and meets the minimum specifications set out in the Documentation.

**"Documentation"** shall mean manuals, instruction guides, user documentation and other related materials of any kind pertaining to the Software (whether in electronic, hard-copy or other media format) that are furnished to Licensee by or on behalf of Ross Video in relation to the Software.

**"Freeware"** means Software that is available free of charge from Ross Video, and includes, without limitation the master control system software known as "DashBoard".

**"Governmental Authority"** means (a) any federal, provincial, state, local, municipal, regional, territorial, aboriginal, or other government, governmental or public department, branch, ministry, or court, domestic or foreign, including any district, agency, commission, board, arbitration panel or authority and any subdivision of any of them exercising or entitled to exercise any administrative, executive, judicial, ministerial, prerogative, legislative, regulatory, or taxing authority or power of any nature; and (b) any quasi-governmental or private body exercising any regulatory, expropriation or taxing authority under or for the account of any of them, and any subdivision of any of them.

**"Improvements"** means all inventions, works, discoveries, improvements and innovations of or in connection with the Software, including error corrections, bug fixes, patches and other updates in Object Code form to the extent made available to Licensee in accordance with Ross Video's release schedule.

**"License Fee"** means the fee(s), if any, payable in respect of the Software in accordance with the relevant invoice(s) or other purchase documents delivered in connection with this Agreement.

**"License Period"** means the period of time that Licensee will have the rights granted under this Agreement, as may be specified in an Order.

**"Modifications"** means any enhancements, changes, corrections, translations, adaptations, revisions, developments, upgrades or updates thereto; and "Modify" shall mean the creation of any of the foregoing.

**"Object Code"** means the machine readable executable form of a computer software program.

**"Open Source Components"** means third party Open Source software, libraries or other components.

**"Open Source License"** means the license that governs each Open Source Component.

**"Order"** means the documents provided by Ross Video to Licensee detailing the Ross Video products contemplated for purchase, the corresponding fees and License Period that may apply to the Software, including any and all quotations, purchase orders, acknowledgments, pro formas, invoices and other purchase documentation.

**"Parties"** means both Ross Video and Licensee and "Party" means either one of them as the context requires.

**"Person"** will be broadly interpreted and includes (a) a natural person, whether acting in his or her own capacity, or in his or her capacity as executor, administrator, estate trustee, trustee or personal or legal representative; (b) a corporation or a company of any kind, a partnership of any kind, a sole proprietorship, a trust, a joint venture, an association, an unincorporated association, an unincorporated syndicate, an unincorporated organization or any other association, organization or entity of any kind; and (c) a Governmental Authority.

**"Primary System"** means the Designated Equipment upon which the Software is installed and executed to deliver its intended functionality.

**"Released Claims"** has the meaning ascribed to it in Section 9(b).

**"Released Parties"** has the meaning ascribed to it in Section 9(b).

**"Ross Video"** means Ross Video Limited and its Affiliates.

**"Software"** means the version of the Object Code licensed and delivered to Licensee by Ross Video concurrently with delivery of this Agreement, including without limitation the Freeware, and any subsequent error corrections, updates, Modifications or Improvements provided to Licensee by Ross Video pursuant to this Agreement, but specifically excluding any features or plug-ins that may be purchased by you directly from third parties as upgrades or enhancements to the Software.

**"Source Code"** means the human readable form of a computer software program, and all tools and documentation necessary for a reasonably competent computer programmer to understand, maintain and Modify the Software.

**"Third Party Software"** means those portions of the Software, if any, which are owned or controlled by third parties and licensed to Ross Video pursuant to certain license agreements or arrangements with such third parties, including the Open Source Components and NDI®<sup>1</sup> software (<http://NDI.video>); and

**"Use"** means to execute, run, display, store, merge, network, Modify, translate, host or integrate with Licensee's products or other third party software.

<sup>1</sup> NDI® is a registered trademark of Vizrt NDI AB.

3. **LICENSE.** Subject to the terms and conditions of this Agreement, upon payment of the applicable License Fee by Licensee, or, in the case of Freeware only, upon download of the Software by Licensee onto its Designated Equipment, Ross Video hereby grants to Licensee a non-transferable and non-exclusive right to Use the Software and Documentation solely for the internal use of Licensee (the "License"), during the License Period. In the event that a License Period is not identified on the Order, such License Period shall be deemed to be perpetual, subject to paragraph 10 (c) of this Agreement. The Software shall only be used in connection with or installed on the Designated Equipment and, where applicable, shall only be used on the Primary System, provided such Primary System is operating properly."

If the Primary System is not operating properly for any reason, the Software may be used on the designated Backup System for that Primary System until such time that the Primary System begins operating properly. The Software and Documentation are provided to Licensee for the exclusive use by Licensee's organization for its ordinary business purposes and shall not be used by any third party for any purposes. Licensee may make copies of the Software as required for internal backup and archival purposes. To the extent permitted hereunder, Licensee may distribute copies of the Software and/or Documentation to members of its organization, provided (a) this Agreement is included with each copy, (b) any member of its organization who uses the Software and/or Documentation accepts and agrees to be bound by the terms of this Agreement and by any other license agreements or other agreement incorporated by reference into this Agreement, and (c) Licensee has paid any applicable additional License Fees in respect of copying and redistributing of the Software. To the extent Licensee is permitted to make copies of the Software under this Agreement, Licensee agrees to reproduce and include on any copy made or portion merged into another work, all Ross Video proprietary notices, including any notices with respect to copyrights, trademarks and this License. With the exception of copying the Software for backup or archival purposes, Licensee agrees to keep a record of the number and location of all such copies and will make such record available at Ross Video's request. The Software may include mechanisms to limit or inhibit copying.

4. **LICENSE RESTRICTIONS.** Except as otherwise provided in section 3 above, Licensee shall not: (1) copy any Software or Documentation, or part thereof, which is provided to Licensee by Ross Video pursuant to this Agreement, in Object Code form, Source Code form or other human or machine readable form, including written or printed documents, without the prior written consent of Ross Video; (2) in any way market, distribute, export, translate, transmit, merge, Modify, transfer, adapt, loan, rent, lease, assign, share, sub-license, sell, make available for download on any website or make available to another Person, the Software and/or Documentation, in whole or in part, provided that Licensee shall not be prohibited from renting or leasing the Software if Ross Video has consented, in writing, to Licensee engaging in such activities in respect of the Software; (3) reverse engineer, decompile or disassemble the Software or electronically transfer it into another computer language; or (4) use the Software or Documentation in a manner that is inconsistent with the License granted hereunder or that will result in a breach of this Agreement. Licensee agrees to take all reasonable precautions to prevent third parties from using the Software and/or Documentation in any way that would constitute a breach of this Agreement, including such precautions Licensee would ordinarily take to protect its own proprietary software, hardware or information.
5. **DELIVERY.** Ross Video shall deliver to Licensee one (1) master copy of the Software in compiled binary (executable) form suitable for reproduction in electronic files only and Ross Video shall deliver to Licensee a minimum of one copy of the Documentation.
6. **IMPROVEMENTS.** Licensee may from time to time request Ross Video to incorporate certain Improvements into the Software. Ross Video may, in its sole discretion, undertake to incorporate and provide such Improvements to Licensee with or without payment of a fee to be negotiated at the time of such request. All Improvements, whether recommended and developed by Ross Video or Licensee, shall be considered the sole property of Ross Video and shall be used by Licensee pursuant to the terms of the License granted under this Agreement.

7. **FREWARE.** Other than the obligation to pay a License Fee, which does not apply to the Freeware, all other provisions of this End User Software License Agreement apply to the Freeware in the same way as they apply to all other Software that is the subject of this Agreement. In addition, in connection with the Freeware, the following provisions apply:
  - a. Licensee will not Use the Freeware to engage in or allow others to engage in any illegal activity.
  - b. Licensee will not Use the Freeware in any way that will interfere with or damage the operation of the services of any third parties by overburdening/disabling network resources through automated queries, excessive usage or similar conduct.
  - c. Licensee will not Use the Freeware to engage in any activity that will violate the rights of others, including, without limitation, by using it for operations that involve child labour, suppressing the right of freedom of expression or endangering the security of person.
8. **OWNERSHIP.** The Parties acknowledge and agree that, as between the Parties, Ross Video shall be the owner of all intellectual property rights in the Software, Documentation and all related Modifications and Improvements, written materials, logos, trademarks, trade names, copyright, patents, trade secrets and moral rights, registered or unregistered. No proprietary interest or title in or to the intellectual property in the Software, Documentation or any Improvements or Modifications is transferred to Licensee by this Agreement. Ross Video reserves all rights not expressly licensed to Licensee under section 3.
9. **OPEN SOURCE SOFTWARE.**
  - a. Software may use and/or be provided with Open Source Components, including those detailed in the Third Party section below. To the extent stipulated by its Open Source License, each such Open Source Component is licensed directly to Licensee from its respective licensors and not sub-licensed to Licensee by Ross Video, and such Open Source Component is subject to its respective Open Source License, and not to this Agreement. If, and to the extent, an Open Source Component requires that this Agreement effectively impose, or incorporate by reference, certain disclaimers, permissions, provisions, prohibitions or restrictions, then such disclaimers, permissions, provisions, prohibitions or restrictions shall be deemed to be imposed, or incorporated by reference into this Agreement, as required, and shall supersede any conflicting provision of this Agreement, solely with respect to the corresponding Open Source Component which is governed by such Open Source License.
  - b. If Licensee, or another party on Licensee's behalf, modifies, replaces or substitutes any Open Source Component used in or provided with this Software, Licensee hereby fully, forever, irrevocably and unconditionally releases and discharges Ross Video, its Affiliates and its and their employees, officers, directors, resellers, distributors and representatives (collectively, "Released Parties") from any and all claims, charges, complaints, demands, actions, causes of action, suits, rights, debts, covenants, liabilities, warranties, performance and maintenance and support obligations (collectively, "Released Claims"), of every kind and nature, with respect to such Software, including without limitation any such Released Claims that arise as a matter of applicable Law.
  - c. If an Open Source License requires that the source code of its corresponding Open Source Component be made available to Licensee, and such source code was not delivered to Licensee with the Software, then Ross Video hereby extends a written offer, valid for the period prescribed in such Open Source License, to obtain a copy of the source code of the corresponding Open Source Component, from Ross Video from <https://www.rossvideo.com/open-source-information/>.

## 10. **THIRD PARTY SOFTWARE.**

- a. Licensee acknowledges that the Third Party Software is not owned by Ross Video. Notwithstanding any other provision of this Agreement, Ross Video, to the extent permitted by applicable law, offers no warranties (whether express, implied, statutory or by course of communication or dealing with Licensee, or otherwise) with respect to the Third Party Software. Ross Video may pass through to Licensee, if and to the extent permitted by applicable law, any warranties expressly provided by such third parties to Ross Video for such Third Party Software.
- b. FFmpeg Notice. The Software may utilize FFmpeg video components and their included libraries. FFmpeg is a trademark of Fabrice Bellard (originator of the FFmpeg project). Ross Video disclaims any ownership claim to FFmpeg. Please refer to <http://ffmpeg.org> (copyright is in the FFmpeg developers). FFmpeg is licensed under the GNU Lesser General Public License v2.1 or Lesser General Public License v3.0. GNU Lesser General Public License contact information: Free Software Foundation, Inc., 51 Franklin Street, Fifth Floor, Boston, MA 02110-1301 USA. Licensee can distribute it and/or modify it under the terms of such licenses.

## 11. **INTELLECTUAL PROPERTY INDEMNITY.**

- a. Ross Video agrees to defend, indemnify and hold harmless Licensee from final damages awarded by a court of competent jurisdiction (hereinafter referred to as the "**Losses**"), which Licensee, or any of its officers or directors, may incur, suffer or become liable for as a result of, or in connection with, any third party claim asserted against Licensee to the extent such claim is based on a contention that the Software, Documentation or any portion thereof, infringes any valid, registered, enforceable patents, copyrights, trade secrets, trademarks or other intellectual property rights of any third party, provided that (a) the allegedly infringing Software or Documentation has been used within the scope of and in accordance with the terms of this Agreement, and (b) Licensee notifies Ross Video in writing of such claim within ten (10) days of a responsible officer of Licensee becoming aware of such claim. If the Software, Documentation or any portion thereof is held to constitute an infringement of a third party's intellectual property rights, and use thereof is enjoined, Ross Video shall, at its election and expense, either (i) procure the right to use the infringing element of the Software or Documentation; or (ii) replace or modify the element of the Software or Documentation so that the infringing portion is no longer infringing and still performs the same function without any material loss of functionality. Ross Video shall make every reasonable effort to correct the situation with minimal effect upon the operations of Licensee.
- b. Notwithstanding the above, Ross Video reserves the right to terminate this Agreement and the License granted hereunder on immediate notice to Licensee, and without liability to Licensee, in the event that the Software or Documentation constitutes or may, in Ross Video's determination, constitute, an infringement of the rights of a third party that Ross Video, in its sole discretion, does not consider to be affordably remediable.
- c. Either party may terminate this Agreement immediately should any Software become, or in either party's opinion be likely to become, the subject of a claim of infringement of any intellectual property right and, in such event, there shall be no claim by either Licensee or Ross Video against the other arising out of such termination, provided that the foregoing shall not apply to a claim for infringement by Ross Video against Licensee in the event that Licensee is alleged to have infringed Ross Video's intellectual property rights, in which case Licensee shall remain liable for all outstanding License Fees and other amounts owing to Ross Video.
- d. Notwithstanding the foregoing, Ross Video shall have no liability for any claim of infringement based on use of other than a current, unaltered release of the Software and/or Documentation available from Ross Video if such infringement would have been avoided by the use of a current, unaltered release of the Software and/or Documentation provided that such current, unaltered release performs substantially in conformity with the specifications set out in the Documentation and was provided, at no additional cost by Ross Video, to those subscribing for maintenance services for the Software or Documentation.

12. **CONFIDENTIALITY.** Each Party shall maintain in confidence all Confidential Information of the other Party, shall use such Confidential Information only for the purpose of exercising its rights and fulfilling its obligations under this Agreement, and shall not disclose any Confidential Information of the disclosing Party to any third party except as expressly permitted hereunder or make any unauthorized use thereof. Each Party shall disclose the Confidential Information only to those of its employees, consultants, advisors, and/or subcontractors who have a need to know the Confidential Information. Each Party shall, prior to disclosing the Confidential Information to such employees, consultants, advisors and/or subcontractors, obtain their agreement to receive and use the Confidential Information on a confidential basis on the same terms and conditions contained in this Agreement. The receiving Party shall treat the Confidential Information of the disclosing Party with the same degree of care against disclosure and/or unauthorized use as it affords to its own information of a similar nature, or a reasonable degree of care, whichever is greater. The receiving Party further agrees not to remove or destroy any proprietary or confidential legends or markings placed upon any documents or other materials of the disclosing Party. The obligations of confidence set forth in this Agreement shall extend to any Affiliates that have received Confidential Information of the disclosing Party and shall also cover Confidential Information disclosed by any Affiliate. The receiving Party shall be responsible for any actions or omissions of its Affiliates as if such actions or omissions were its own.

Either party may disclose certain Confidential Information if it is expressly required to do so pursuant to legal, judicial, or administrative proceedings, or otherwise required by law, provided that (i) such Party provides the other Party with reasonable written notice prior to such disclosure; (ii) such Party seeks confidential treatment for such Confidential Information; (iii) the extent of such disclosure is only to the extent expressly required by law or under the applicable court order; and (iv) such Party complies with any applicable protective or equivalent order.

Each of Ross Video and Licensee (the "**Indemnifying Party**", as applicable) agree to indemnify the other (the "**Indemnified Party**", as applicable) for all Losses incurred by the Indemnified Party as a result of a failure of the Indemnifying Party to comply with its obligations under this Section 12 provided that the Indemnified Party has given prompt notice of any such claim and, to the extent that a claim may lie against a third party for the unauthorized disclosure of such Confidential Information, the right to control and direct the investigation, preparation, action and settlement of each such claim and, further, provided that the Indemnified Party reasonably co-operates with the Indemnifying Party in connection with the foregoing and provides the Indemnifying Party with all information in the Indemnified Party's possession related to such claim and such further assistance as reasonably requested by the Indemnifying Party.

The Parties acknowledge and agree that any breach of the confidentiality provisions of this Agreement by one Party may cause significant and irreparable injury to the other Party that is not compensable monetarily, as well as damages that may be difficult to ascertain, and agrees that, in addition to such other remedies that may be available at law or in equity, the other Party shall be entitled to seek injunctive relief (including temporary restraining orders, interim injunctions and permanent injunctions) in a court of competent jurisdiction in the event of the breach or threatened breach by such party of any of the confidentiality provisions of this Agreement. The relief contemplated in this Section shall be available to each Party without the necessity of having to prove actual damages and without the necessity of having to post any bond or other security. Each Party further agrees to notify the other Party in the event that it learns of or has reason to believe that any Person has breached the confidentiality provisions of this Agreement.

13. **LIMITATION OF LIABILITY.** The limitation of liability provisions of this Agreement reflect an informed voluntary allocation of the risks (known and unknown) that may exist in connection with the licensing of the Software or Documentation hereunder by Ross Video, and that voluntary risk allocation represents a material part of the Agreement reached between Ross Video and Licensee. Should Ross Video be in breach of any obligation, Licensee agrees that Licensee's remedies will be limited to those set forth in this Agreement. No action, regardless of form, arising out of this Agreement may be brought by Licensee more than twelve (12) months after the facts giving rise to the cause of action have occurred, regardless of whether those facts by that time are known to, or reasonably ought to have been discovered by, Licensee.

(A) EXCEPT AS EXPRESSLY PROVIDED IN THIS AGREEMENT, THE SOFTWARE AND DOCUMENTATION ARE PROVIDED "AS IS" AND ROSS VIDEO (I) MAKES NO OTHER REPRESENTATIONS, AND PROVIDES NO WARRANTIES OR CONDITIONS OF ANY KIND, EXPRESS OR IMPLIED, STATUTORY, BY USAGE OF TRADE CUSTOM OF DEALING, OR OTHERWISE, AND (II) SPECIFICALLY DISCLAIMS ALL IMPLIED WARRANTIES INCLUDING ANY IMPLIED WARRANTY OF UNINTERRUPTED OR ERROR FREE OPERATION, MERCHANTABILITY, QUALITY OR FITNESS FOR A PARTICULAR PURPOSE. ROSS VIDEO DOES NOT REPRESENT OR WARRANT THAT THE SOFTWARE WILL MEET ANY OR ALL OF LICENSEE'S PARTICULAR REQUIREMENTS, THAT THE USE AND OPERATION OF THE SOFTWARE WILL OPERATE ERROR-FREE OR UNINTERRUPTED, THAT ALL PROGRAMMING ERRORS IN THE SOFTWARE CAN BE FOUND IN ORDER TO BE CORRECTED, OR THAT THE SOFTWARE WILL BE COMPATIBLE WITH OTHER PROGRAMS, SYSTEMS, AND HARDWARE.

(B) IN NO EVENT SHALL ROSS VIDEO, ITS AFFILIATES AND LICENSORS, AND THEIR RESPECTIVE DIRECTORS, OFFICERS, EMPLOYEES AND AGENTS, BE LIABLE FOR ANY CLAIM FOR INDIRECT, CONSEQUENTIAL, SPECIAL, INCIDENTAL, PUNITIVE, EXEMPLARY, AGGRAVATED DAMAGES; LOST PROFITS, OR LOST REVENUE ARISING FROM OR IN CONNECTION WITH THIS AGREEMENT, REGARDLESS OF THE FORM OF ACTION, WHETHER IN CONTRACT, OR IN TORT, EVEN IF THE PARTY HAS BEEN ADVISED OF THE POSSIBILITY OF SUCH DAMAGES.

(C) IN ANY EVENT THE AGGREGATE LIABILITY OF ROSS VIDEO, ITS AFFILIATES AND LICENSORS, AND THEIR RESPECTIVE DIRECTORS, OFFICERS, EMPLOYEES AND AGENTS, FOR ANY CLAIM FOR DIRECT DAMAGES WITH RESPECT TO THE SUBJECT MATTER OF THIS AGREEMENT SHALL NOT EXCEED THE AMOUNT OF THE PURCHASE PRICE PAID TO ROSS VIDEO UNDER THIS AGREEMENT.

14. **TERM AND TERMINATION.**

- (1) Unless terminated earlier in accordance with the terms of this Agreement, the term of this Agreement shall commence upon Licensee's first download, access, installation, or other use of the Software or Documentation and continues until, in the case of Software licensed with Designated Equipment provided by Ross Video, the earliest of (a) the end of the License Period, or (b) if the Designated Equipment is assigned or transferred in accordance with this Agreement, the date on which the Designated Equipment is no longer owned by Licensee;
- (2) Either Party shall have the right to terminate this Agreement on notice to the other Party if:
  - (a) the other Party fails to pay any fees or other amounts when due hereunder or under any other agreement between the Parties (or any Affiliates of the Parties, as applicable) in connection with the Software and/or Designated Equipment and such breach is not cured within thirty (30) days after written notice of such failure to pay is given to the defaulting Party by the non-defaulting Party;
  - (b) the other Party shall file a voluntary petition in bankruptcy or insolvency or shall petition for reorganization under any bankruptcy law, consent to an involuntary petition in bankruptcy, or if a receiving order is given against it under the Bankruptcy and Insolvency Act (Canada) or the comparable law of any other jurisdiction (and such is not dismissed within ten (10) days);

- (c) there shall be entered an order, judgment or decree by a court of competent jurisdiction, upon the application of a creditor, approving a petition seeking reorganization or appointing a receiver, trustee or liquidator of all or a substantial part of the other Party's assets and such order, judgment or decree continues in effect for a period of thirty (30) consecutive days; or
- (d) the other Party shall fail to perform any of the other material obligations set forth in this Agreement and such default, in the case of a default which is remediable, continues for a period of thirty (30) days after written notice of such failure has been given by the non-defaulting Party or, in the case of a non-remediable default, immediately upon notice.

(3) Notwithstanding anything to the contrary contained in this Agreement:

- (a) Ross Video may forthwith terminate this Agreement if Licensee is in breach of any of sections 3, 4 or 12 of this Agreement. For greater certainty, in such instances Ross Video shall provide written notice of such termination as soon as practicable but written notice shall not be a necessary prerequisite to such termination; and
- (b) in the event of a Change of Control of Licensee, Ross Video shall have the right to terminate this Agreement and the License granted hereunder upon thirty (30) days' prior written notice to Licensee. For greater certainty, Ross Video's right to terminate in the event of a Change of Control of Licensee shall continue for a period of six (6) months from the date Licensee delivers notice of such Change of Control to Ross Video.
- (c) Ross Video may terminate the License immediately on the date on which it provides notice to Licensee, if its agreements for Third Party Software are terminated.

(4) Upon the termination or expiry of this Agreement:

- (a) Licensee shall immediately cease and desist all use of the Software and Documentation;
- (b) Licensee shall immediately deliver to Ross Video any of Ross Video's Confidential Information provided hereunder (including the Software and Documentation) then in its possession or control, if any, and shall deliver a certificate of an officer of Licensee certifying the completeness of same;
- (c) Licensee shall refrain from further use of such Confidential Information; and
- (d) Licensee shall forthwith pay all amounts owing to Ross Video or any of its Affiliates hereunder.

15. **SURVIVAL.** The provisions of sections 1, 2, 6, 8, 9, 10, 11, 12, 13, 14, 18, 22, 23, and 24 herein shall survive the expiry or termination of this Agreement.
16. **FORCE MAJEURE.** Dates and times by which Ross Video is required to render performance under this Agreement shall be automatically postponed to the extent and for the period that Ross Video is prevented from meeting them by reason of events of force majeure or any cause beyond its reasonable control provided Ross Video notifies Licensee of the commencement and nature of such cause and uses its reasonable efforts to render performance in a timely manner.
17. **ASSIGNMENT.** Ross Video may assign this Agreement, or any of its rights or obligations hereunder, in whole or in part, upon notice to Licensee. Licensee shall not assign this Agreement, or any of its rights or obligations hereunder, in whole or in part, without the prior written consent of Ross Video, which consent may not be unreasonably withheld. This Agreement enures to the benefit of and is binding upon each of the Parties and their respective successors and permitted assigns.

18. **GOVERNING LAW.** If Licensee acquired the Ross Product(s) in the United States or Canada, the laws of the state or province where Licensee's principal place of business is located govern the interpretation of this Agreement, claims for its breach, and all other claims regardless of conflict of laws principles. If Licensee acquired the Ross Product(s) in the European Union or the United Kingdom, then the laws of England and Wales apply. If Licensee acquired the Ross Product(s) in any other country, then the laws of the Province of Ontario, Canada shall apply.
19. **LANGUAGE.** The Parties have expressly required that this Agreement and all documents relating thereto be prepared in English. Les parties ont expressément exigé que cette convention ainsi que tous les documents qui s'y rattachent soient rédigés en anglais.
20. **GOVERNMENT CONTRACTS.** If the Software and/or Documentation to be furnished to Licensee hereunder are to be used in the performance of a government contract or subcontract, the Software and/or Documentation shall be provided on a "restricted rights" basis only and Licensee shall place a legend, in addition to applicable copyright notices, in the form provided under the applicable governmental regulations. For greater certainty, Ross Video shall not be subject to any flow-down provisions required by any customer of Licensee that is a Governmental Authority unless Ross Video expressly agrees to be bound by such flow-down provisions in writing.
21. **EXPORT AND IMPORT LAWS.** Licensee acknowledges and agrees that the Software (including any technical data and related technology) may be subject to the export control laws, rules, regulations, restrictions and national security controls of the United States and other applicable countries (the "**Export Controls**") and agrees not to export, re-export, import or allow the export, re-export or import of such export-controlled Software (including any technical data and related technology) or any copy, portion or direct product of the foregoing in violation of the Export Controls. Licensee hereby represents that it is not an entity or person to whom provision of the Software (including any technical data and related technology) is restricted or prohibited by the Export Controls. Licensee agrees that it has the sole responsibility to obtain any authorization to export, re-export, or import the Software (including any technical data and related technology), as may be required. Licensee will defend, indemnify and hold Ross Video harmless from any and all claims, losses, liabilities, damages, fines, penalties, costs and expenses (including attorney's fees) arising from or relating to any breach by Licensee of its obligations under this Section.
22. **AMENDMENT AND WAIVER.** No amendment, discharge, modification, restatement, supplement, termination or waiver of this Agreement or any Section of this Agreement is binding unless it is in writing and executed by the Party to be bound. No waiver of, failure to exercise or delay in exercising, any Section of this Agreement constitutes a waiver of any other Section (whether or not similar) nor does any waiver constitute a continuing waiver unless otherwise expressly provided.
23. **SEVERABILITY.** Each Section of this Agreement is distinct and severable. If any Section of this Agreement, in whole or in part, is or becomes illegal, invalid, void, voidable or unenforceable in any jurisdiction by any court of competent jurisdiction, the illegality, invalidity or unenforceability of that Section, in whole or in part, will not affect (a) the legality, validity or enforceability of the remaining Sections of this Agreement, in whole or in part; or (b) the legality, validity or enforceability of that Section, in whole or in part, in any other jurisdiction.
24. **ENTIRE AGREEMENT.** This Agreement, and any other documents referred to herein, constitutes the entire agreement between the Parties relating to the subject matter of this Agreement and supersedes all prior written or oral agreements, representations and other communications between the Parties.

*Updated: November 1, 2023*

# Warranty and Repair Policy

Ross Video Limited (Ross) warrants its PIERO systems to be free from defects under normal use and service for the following time periods from the date of shipment:

- PIERO Server — 12 months
- PIERO Software Upgrades — 12 months free of charge
- System and Media hard drives — 12 months

If an item becomes defective within the warranty period Ross will repair or replace the defective item, as determined solely by Ross.

Warranty repairs will be conducted at Ross, with all shipping FOB Ross dock. If repairs are conducted at the customer site, reasonable out-of-pocket charges will apply. At the discretion of Ross, and on a temporary loan basis, plug in circuit boards or other replacement parts may be supplied free of charge while defective items undergo repair. Return packing, shipping, and special handling costs are the responsibility of the customer.

This warranty is void if products are subjected to misuse, neglect, accident, improper installation or application, or unauthorized modification.

In no event shall Ross Video Limited be liable for direct, indirect, special, incidental, or consequential damages (including loss of profit). Implied warranties, including that of merchantability and fitness for a particular purpose, are expressly limited to the duration of this warranty.

This warranty is TRANSFERABLE to subsequent owners, subject to Ross' notification of change of ownership.

## Extended Warranty

For customers that require a longer warranty period, Ross offers an extended warranty plan to extend the standard warranty period by one year increments. For more information about an extended warranty for your PIERO system, contact your regional sales manager.

# Environmental Information

The equipment that you purchased required the extraction and use of natural resources for its production. It may contain hazardous substances that could impact health and the environment.

To avoid the potential release of those substances into the environment and to diminish the need for the extraction of natural resources, Ross Video encourages you to use the appropriate take-back systems. These systems will reuse or recycle most of the materials from your end-of-life equipment in an environmentally friendly and health conscious manner.

The crossed-out wheeled bin symbol invites you to use these systems.



If you need more information on the collection, reuse, and recycling systems, please contact your local or regional waste administration.

You can also contact Ross Video for more information on the environmental performances of our products.

# Company Address

## **Ross Video Limited**

8 John Street  
Iroquois, Ontario  
Canada, K0E 1K0

## **Ross Video Incorporated**

P.O. Box 880  
Ogdensburg, New York  
USA 13669-0880

---

**General Business Office:** (+1) 613 · 652 · 4886

**Fax:** (+1) 613 · 652 · 4425

**Toll Free Technical Support:** 1-844-652-0645 (North America)  
+800 3540 3545 (International)

**Alternately, you can contact:**

**Technical Support:** (+1) 613 · 652 · 4886

**After Hours Emergency:** (+1) 613 · 349 · 0006

**E-mail for Technical Support:** [techsupport@rossvideo.com](mailto:techsupport@rossvideo.com)

**E-mail for General Information:** [solutions@rossvideo.com](mailto:solutions@rossvideo.com)

**Website:** <http://www.rossvideo.com>

# Contents

<b>Introduction</b> .....	<b>1</b>
About This Guide .....	2
Getting Help .....	3
<b>Installation</b> .....	<b>4</b>
Ubuntu Installation .....	5
<b>PIERO Setup</b> .....	<b>7</b>
Overview .....	8
Hardware Setup .....	9
Starting PIERO in Broadcast Mode .....	14
Modes of Operation Overview .....	16
License Updating .....	22
<b>PIEROTouch</b> .....	<b>23</b>
Installation .....	24
Connecting to PIERO .....	26
Switching Between ON AIR and EDIT Mode .....	27
Control Panel .....	28
Panels Tab .....	29
Buttons Tab .....	32
Background Tab .....	34
Layouts Tab .....	35
Settings Tab .....	36
<b>Virtual Presenter</b> .....	<b>39</b>
<b>Keyboard Language Layout</b> .....	<b>40</b>
<b>Network Setup</b> .....	<b>42</b>
Updating the Hosts File .....	44
Firewall .....	45
<b>ST 2110 Setup and Configuration</b> .....	<b>46</b>
<b>iPad Module</b> .....	<b>57</b>
Network Setup Overview .....	58
Connecting the iPad to PIERO .....	59

OPTA Module .....	60
Importing 3D Models and Sound Effects .....	62
Importing 3D Models .....	63
Importing Sound Effects .....	64
Linux Security Updater .....	65
Checking the Installation of Security Updater .....	66
Installing the PIERO Security Updater .....	68
Updating Security Packages .....	70
MIRA Replay System Integration .....	71
EVS Configuration .....	76
EVS Multicam (10.xx.xx and earlier) .....	77
EVS Multicam (11.xx.xx or later) .....	79
Enabling VITC (XT2 Only) .....	81
Evertz DreamCatcher Configuration .....	84
Video Device Compatibility .....	88
PIERO File Sharing Assistant .....	90
Codec Compatibility .....	94
DashBoard Integration .....	96
Appendix A: Troubleshooting .....	99

# Introduction

Thank you for choosing a Ross Video PIERO system.

Ross Video designed PIERO with the needs of live production in mind. PIERO is a system for adding graphics to sports footage to aid in analysis of incidents in the match and illustrate points made by analysts.

We appreciate your business and sincerely hope that you have a great experience with your new PIERO system. As always, if there is anything we at Ross Video can do to assist you, please do not hesitate to contact us.

# About This Guide

This guide covers the use of the PIERO system.

If, at any time, you have questions pertaining to the operation of PIERO, please contact us at the numbers listed in the section [Getting Help](#)<sup>3</sup>. Our technical staff is always available for consultation, training, or service.

## Documentation Conventions

Special text formats are used in this guide to identify parts of the user interface, text that a user must enter, or a sequence of menus and sub-menus that must be followed to reach a particular command.

### **Bold text**

Bold text identifies a user interface element such as a dialog box, menu item, or button.

For example:

In the **Slug** column, type a slug name for the story.

### *Italic text*

Italic text is used to identify the titles of referenced guides, manuals, or documents.

For example:

For more information, refer to the *DashBoard User Guide*.

### `Courier text`

Courier text identifies text that a user must type.

For example:

In the **Username** box, type `postgres`.

### Menu Sequences

Menu arrows are used in procedures to identify a sequence of menu items that you must follow.

For example:

If a step reads **Server > Save As**, you would select the **Server** menu and then select **Save As**.

### [Hypertext](#)

Identifies a hyperlink to a related topic.

## Getting Help

PIERO documentation is accessible by selecting the **Documentation** icon in the PIERO Launcher.

## Contacting Technical Support

At Ross Video, we take pride in the quality of our products, but if problems occur, help is as close as the nearest telephone.

Our 24-hour Hot Line service ensures you have access to technical expertise around the clock. After-sales service and technical support is provided directly by Ross Video personnel. During business hours (Eastern Time), technical support personnel are available by telephone. After hours and on weekends, a direct emergency technical support phone line is available. If the technical support person who is on call does not answer this line immediately, a voice message can be left and the call will be returned shortly. This team of highly trained staff is available to react to any problem and to do whatever is necessary to ensure customer satisfaction.

### Technical Support:

- 1-844-652-0645 (North America)
- +800 3540 3545 (International)
- After Hours Emergency: (+1) 613-349-0006
- E-mail: [techsupport@rossvideo.com](mailto:techsupport@rossvideo.com)
- Website: <http://www.rossvideo.com>

# Installation

This section describes the CentOS and Ubuntu installation procedures. The first step however, is to get the installation file you need. Use one of the following methods:

- Contact [Tech Support](#) and use the link they provide to download the installer.
- Use the link provided in release emails from the product team.
- Follow the auto-update prompts from the PIERO Launcher, which will take you to a web page where you can download the software update. The installation process is the same for fresh installations as it is for updates.

[Ubuntu Installation](#) 

# Ubuntu Installation

1. Download the PIERO Ubuntu installation file.
2. Double-click the installation file to open the **Installation Manager**.
3. In the **Installation Manager**, select **Install**.

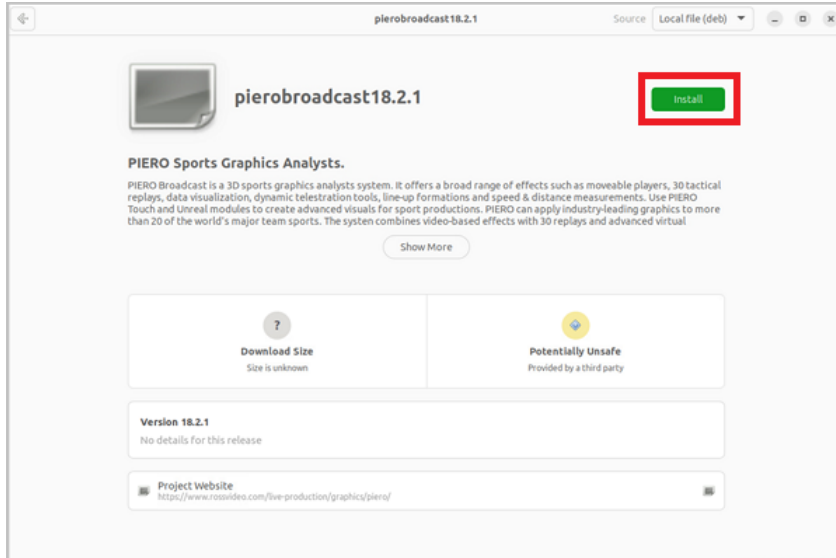

An alert will pop up requesting authentication. PIERO is a trusted software.

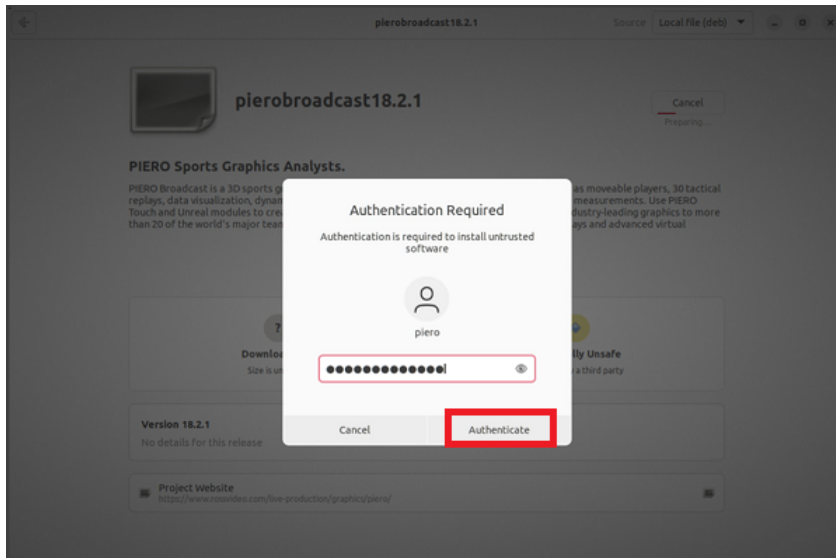

4. Enter the system password and select **Authenticate**.  
PIERO will begin the installation.  
When the installation is complete, you will see PIERO folders on the desktop.
5. Select the corner **X** to close the **Installation Manager**.

6. To make the launcher executable, left-click on the PIERO icon and select **Allow Launching**.

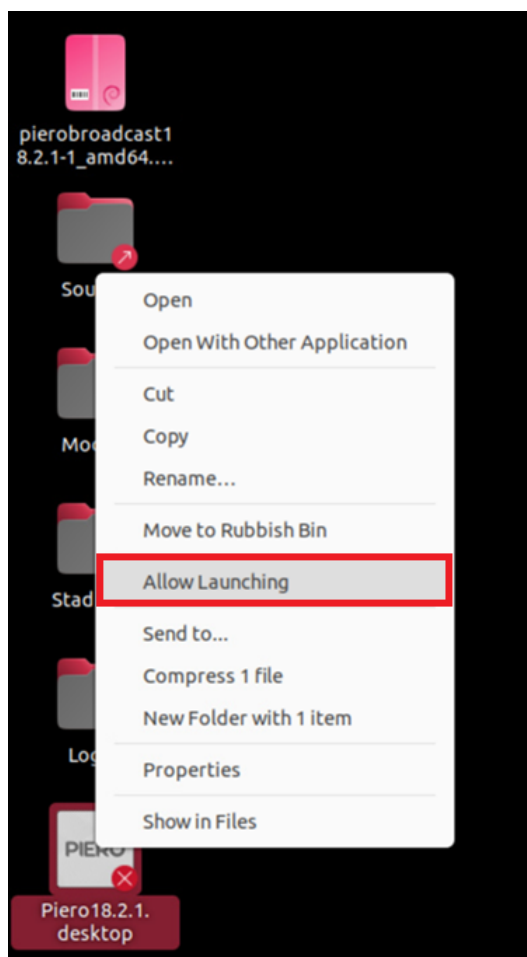

The red **X** on the PIERO icon will disappear.

7. Double-click the PIERO icon to open the PIERO Launcher.

# PIERO Setup

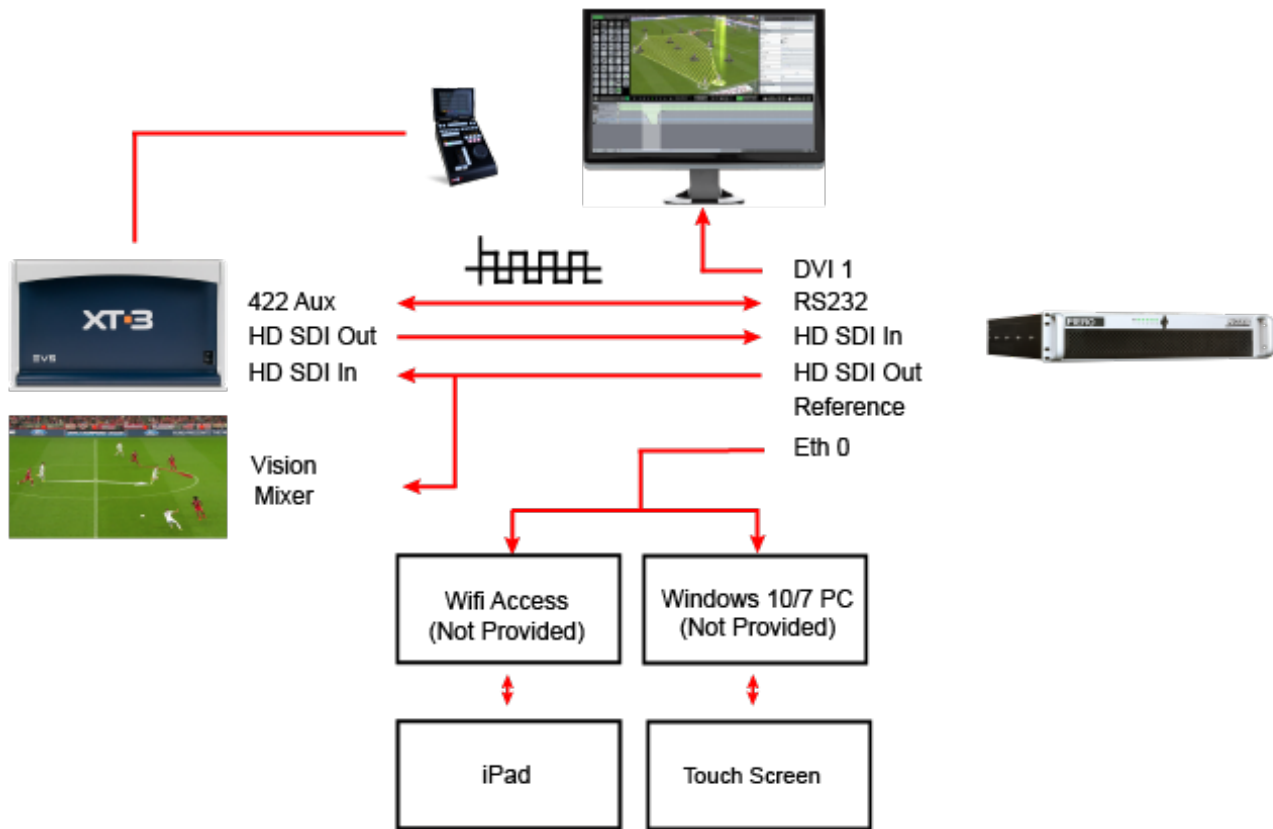

## Signal Flow Diagram

This section covers the following topics:

[Overview](#)

[Hardware Setup](#)

[Starting PIERO in Broadcast Mode](#)

## Overview

PIERO interacts with the video server using supported network control protocols, and 422 for certain systems such as EVS, Grass Valley K2, DigiBeta, and XDCAM. PIERO acquires video via SDI input, applies effects in real-time, and outputs the processed video immediately through SDI output, introducing a fixed delay of 5 frames between input and output.

## Video In/Out

PIERO does not record video internally. The output of the PIERO system must be plugged into another channel in the LSM or to any recording device (DigiBeta, Video Server, etc.).

## Remote Interface

PIERO can control video-playing devices that support the Sony BVW protocol via a standard 422 remote interface, as well as other compatible protocols. On an EVS LSM the parallel mode must be activated (see *PIERO User Guide*).

## GenLock

Sync options include Black Burst and Tri-Level, with Tri-Level recommended for HD. Through the Launcher, both "Black & Burst" and "Tri-Level" reference signals are supported, or the video output can be synchronized with the video input by selecting "SDI-In."

## Timecodes

Timecode is mainly required for analysis and touch features but is not required for Live use. PIERO supports LTC over a 422 cable, though it may not remain in sync and is intended for use with legacy controllers. PIERO also supports video-embedded DVITC, the recommended and preferred timecode format, as well as VITC when compatible.

## Video Formats

PIERO supports the following video formats:

- 2160p 59.94Hz Square
- 2160p 50Hz Square
- 2160p 59.94Hz TSI
- 2160p 50Hz TSI
- 1080p 59.94Hz
- 1080p 50Hz
- 1080i 59.94Hz
- 1080i 50Hz
- 720p 59.94Hz
- 720p 50Hz
- 576i 25Hz (PAL 16:9 and 4:3)
- 480i 29.97Hz (NTSC 16:9 and 4:3)

# Hardware Setup

This section outlines the connections and configurations needed to set up your PIERO system, including both the M9 system from Ross Video Limited and the M8 system. Each numbered item in this chapter corresponds to a labeled component in the accompanying illustrations, helping you identify and correctly connect each part of your setup. For more detailed installation guidance, please refer to the *PIERO Installation Guide* specific to your system model.

★ **Important:** Only use the supplied SDI adapters with the video cards to ensure proper functionality and compatibility.

## M9 1RU System

This is the M9 1RU PIERO hardware sold by Ross Video Limited.

Unpack and connect the PIERO system as illustrated below:

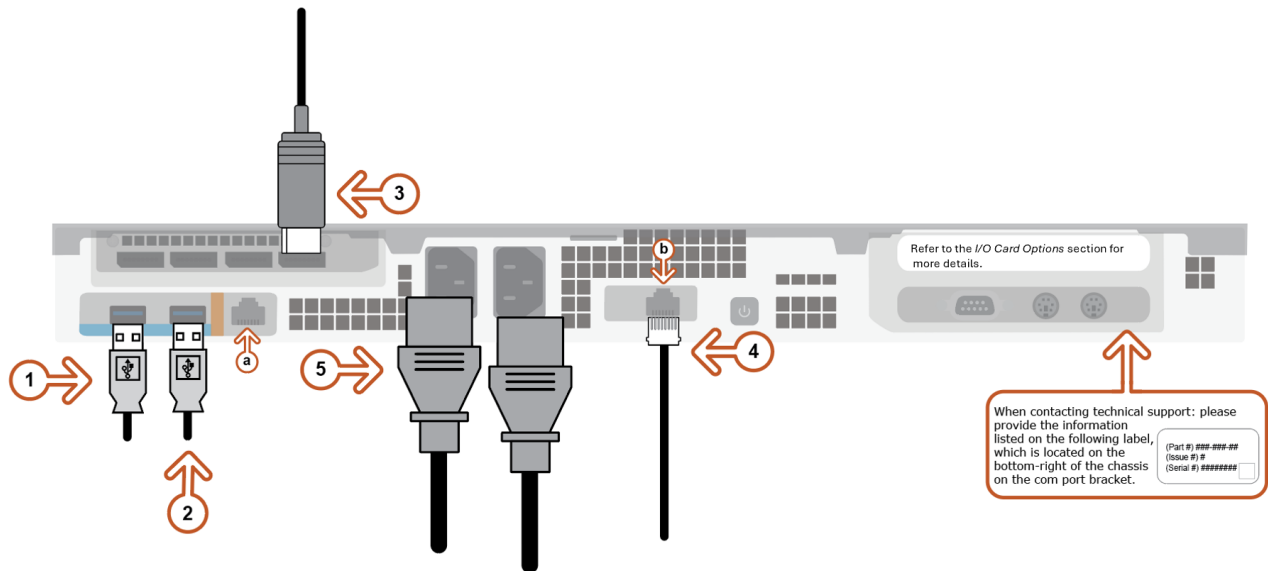

### PIERO M9 1RU Hardware Connections

1. Keyboard
2. Mouse
3. Monitor
4. Ethernet Cable from a Local Area Network into either the 1G (a) or 10G (b) Ethernet port.
5. Power Supplies

## M9 I/O Card Options

The M9 system supports multiple I/O card options to accommodate a range of production workflows. The following tables describe the available options:

### AJA Corvid 88

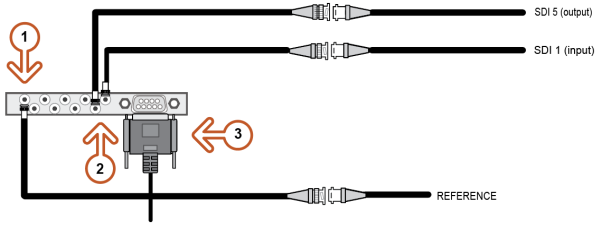
Numbered Parts and Descriptions	HD-SDI Diagram
<ol style="list-style-type: none"> <li>1. <b>REF</b> HD-BNC Connector</li> <li>2. Mini-BNC Connectors</li> <li>3. RS-422 port</li> </ol>	 <p><i>AJA Corvid 88 Card Diagram</i></p>

★ Connectors 1-4 are inputs and connectors 5-8 are outputs by default; however, these connectors can be configured as additional inputs or outputs. All connectors on the Corvid 88 are the same AJA Mini BNC type, and the card ships with BNC adapters.

### DSX LE5 12G

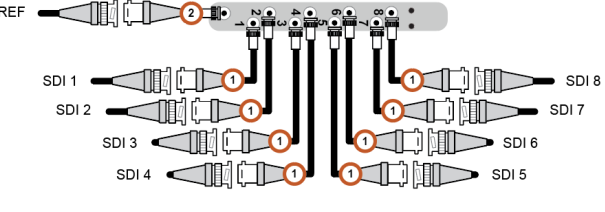
Numbered Parts and Descriptions	DSX LE5 12G Diagram
<ol style="list-style-type: none"> <li>1. HD-BNC connectors</li> <li>2. <b>REF</b> HD-BNC connector</li> </ol>	 <p><i>12G Card Diagram</i></p>

### DSX LE5 D25G

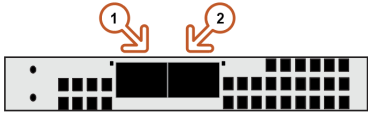
Numbered Parts and Descriptions	DSX LE5 D25 Diagram
<ol style="list-style-type: none"> <li>1. SFP Cage 1</li> <li>2. SFP Cage 2</li> </ol>	

★ The DSX LE5 D25 card has two SFP28 cages, A (primary) and B (redundant), capable of 10GbE or 25GbE. Only SFP A is used for video input and output, while SFP B is used only for ST 2022-7 redundancy.

## M8 2RU System

This is the M8 2RU PIERO hardware sold by Ross Video Limited.

Unpack and connect the PIERO system as illustrated below:

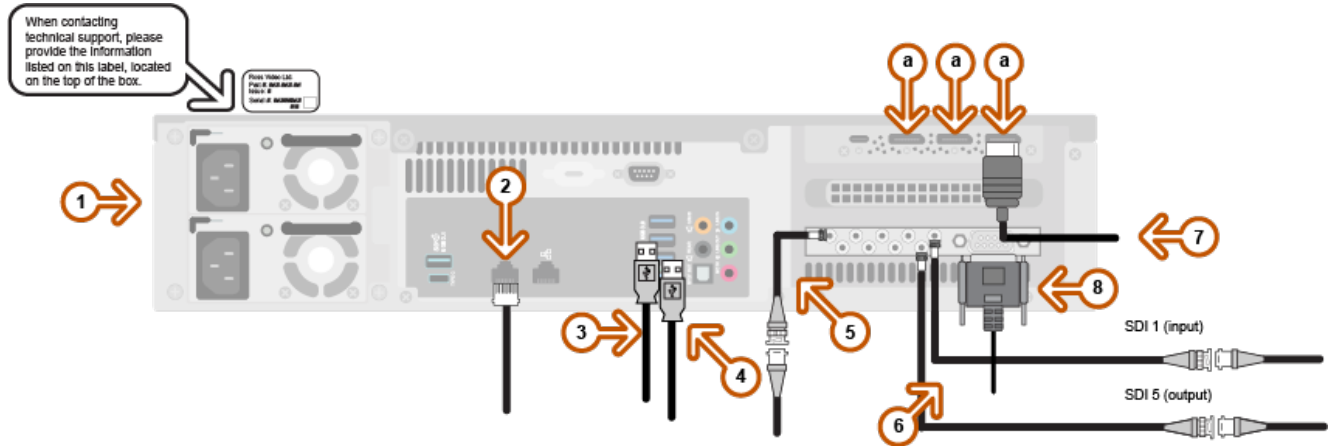

### PIERO M8 2RU Hardware Connections

1. Power supplies
2. LAN controller - use to connect to an internal network
3. Keyboard
4. Mouse
5. Analog reference
6. SDI video input and output
7. Monitor - use any of 3 display ports (a)
8. RS422 port - controls a video replay server

## Generation 5, 6, 6+ and 7 Systems

This is the PIERO hardware sold by PIERO before its acquisition by Ross Video Limited.

Unpack and connect the PIERO system as illustrated below:

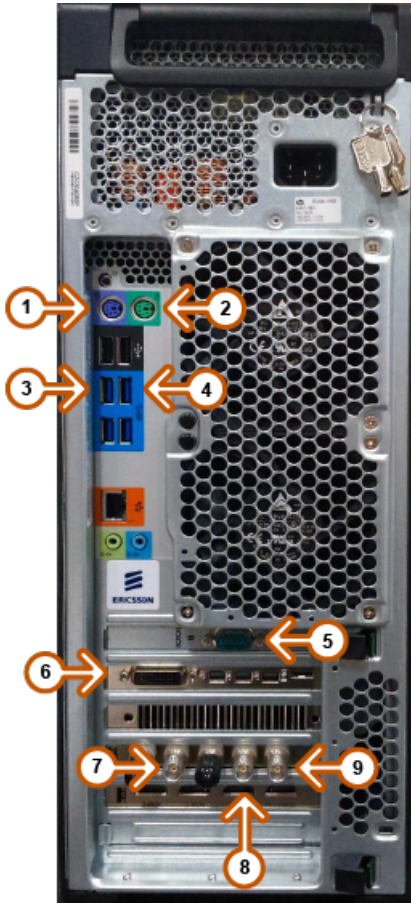

*PIERO Legacy Hardware Connections*

1. Keyboard
2. Mouse
3. Touch screen USB connection
4. License key
5. VTR remote control (232 to 422).

Use the Adenda RS2/8 amplifier-converter with a direct connection. Do not use a patch panel, as they incur variable latency.

6. Monitor DVI connection on NVIDIA DVI-1.

To use the mini HDMI or mini display port, contact [techsupport@rossvideo.com](mailto:techsupport@rossvideo.com), as a change in Linux settings is required.

7. Digital video out - Connect to (HD) SDI OUT A.
8. Digital video in - Connect to (HD) SDI IN A.
9. Reference - Connect to REF IN.

## Starting PIERO in Broadcast Mode

When using the PIERO Broadcast version, you will first need to configure a few settings.

### To start PIERO:

1. Start the PIERO PC.
2. When prompted, enter the password (piero).
3. Double-click the PIERO icon on the desktop to start the application.

The PIERO launcher will appear.

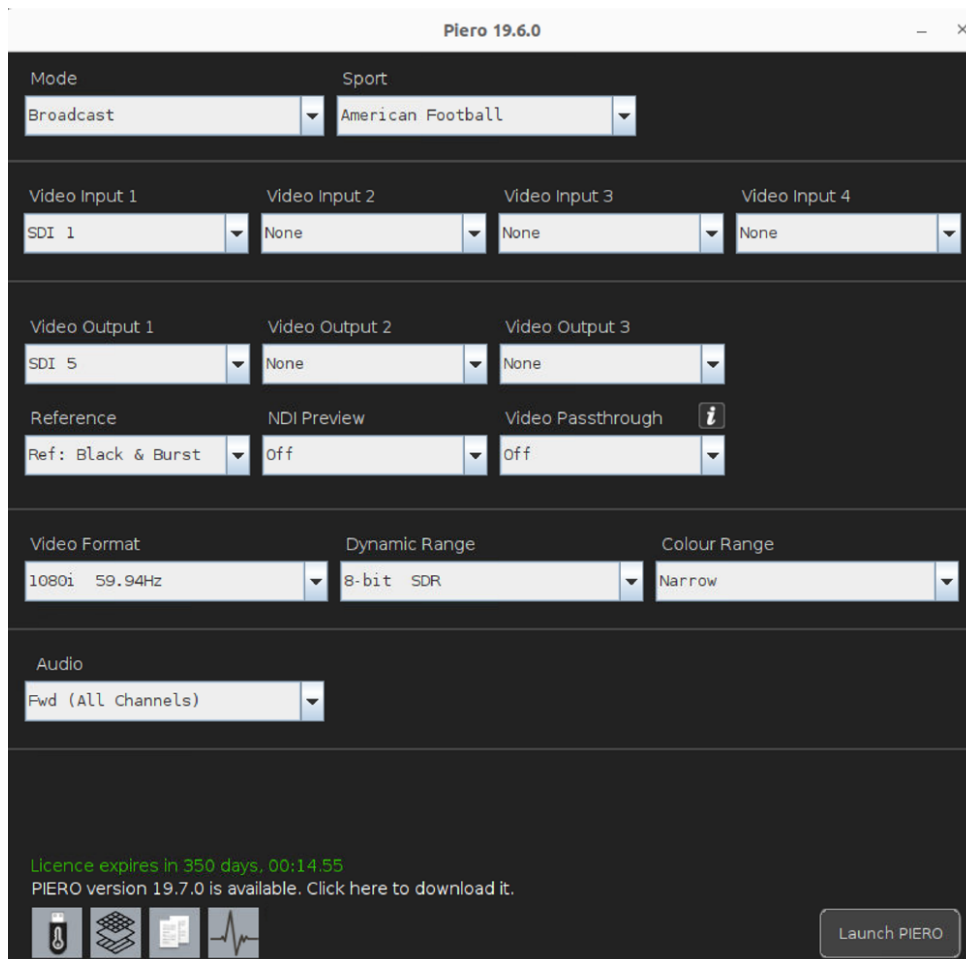

*PIERO Launcher*

4. Select the appropriate video input, audio mode, reference (**SDI-In, Black & Burst** or **Tri-Level**), and sport.
5. Select **Launch PIERO**.

6. In the **Settings** panel, in the **General** tab, select the preferred **Timecode**.

We highly recommend **DVITC** when working in HD. Only use **LTC** or **DLTC** if your video server is unable to embed **DVITC** timecode. All EVS LSMs are capable of providing DVITC timecodes.

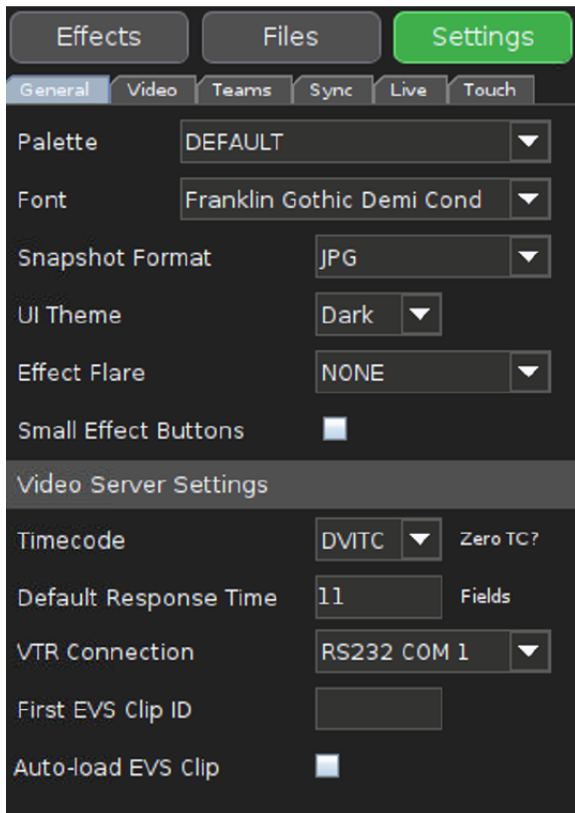

*Settings - General Tab*

If the timecode is displayed against a black background, then it is correct. If it is displayed against an orange background, it indicates there is a problem with the sync (reference). PIERO can sync on SDI-In, Black & Burst and Tri-Level. Tri-Level is recommended for HD.



*Timecode Okay*

7. Adjust the **VTR Response Time**.

This is the time needed for a **Stop** command issued by PIERO over the 422 cable to actually stop the video. Test this using a **VTR Control Effect** (pause point).

For further information see [Calculating the Correct Response Time](#)<sup>[103]</sup>.

8. If you are using an EVS LSM with the XtendDD35, select the **Auto-load EVS Clip** checkbox to allow PIERO to send the load clip command when reloading a stack named after the EVS clip.
9. Select the color **Palette** and **Font** to be used on the system.

## Modes of Operation Overview

PIERO offers unique operating features on the Ross Video Abekas Mira, creating an integrated solution not available with other video servers. In addition, PIERO can control and align telestrated graphics playback on video servers like Evertz DreamCatcher, EVS LSM, and Grass Valley K2, using the AMP protocol or serial RS-422. While PIERO does not record video, it telestrates over input video played by a video server, such as the Ross Video Abekas Mira. It can also synchronize telestration playback timing with pre-recorded clips stored on shared storage. When operating with HD-SDI input and output, PIERO introduces a fixed 5-7 frame delay.

This section details the following modes of operation:

- **PIERO Broadcast - Operational Modes**

- [SDI In, SDI Out](#) 

- [File In, SDI Out](#) 

- [File In, File Out](#) 

- [PIERO Touch Mode](#) 

- **PIERO Live - Operational Mode**

- [PIERO Live Presentation](#) 

## SDI In, SDI Out

- Real-time playback, fastest workflow.
- Timecode integration is optional but not required.

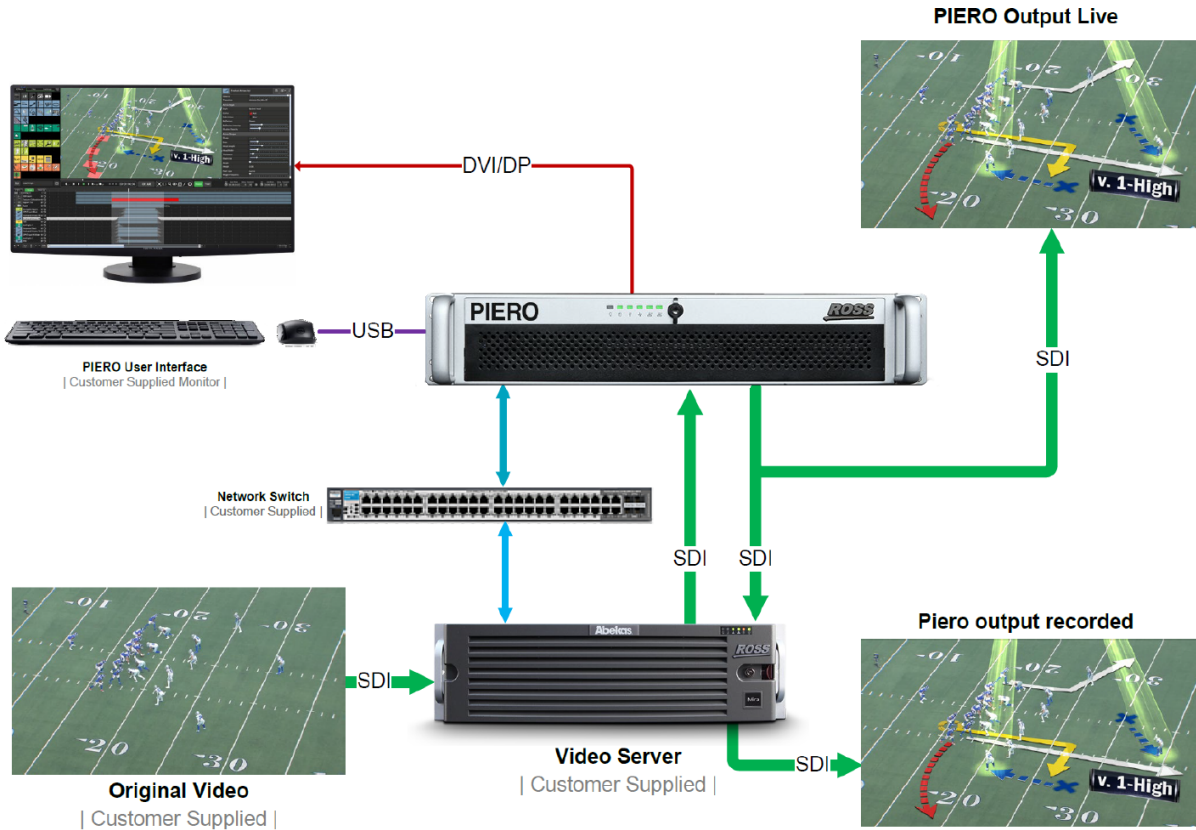

Operation Overview - SDI In/Out

## File In, SDI Out

- Watch folder setup gives the PIERO Operator easy access to a library of clips (video files) over a network.
  - ★ FTP or SAMBA can be used as part of this setup, but files should not be edited directly from a remote mount.
- Real-time playback.
- PIERO Output back into replay system, video router, or play directly from PIERO.
- A contour jog wheel can be used with PIERO for precise control when working with File In items.
- Extensive codec library list in section Video Codecs Supported in PIERO.

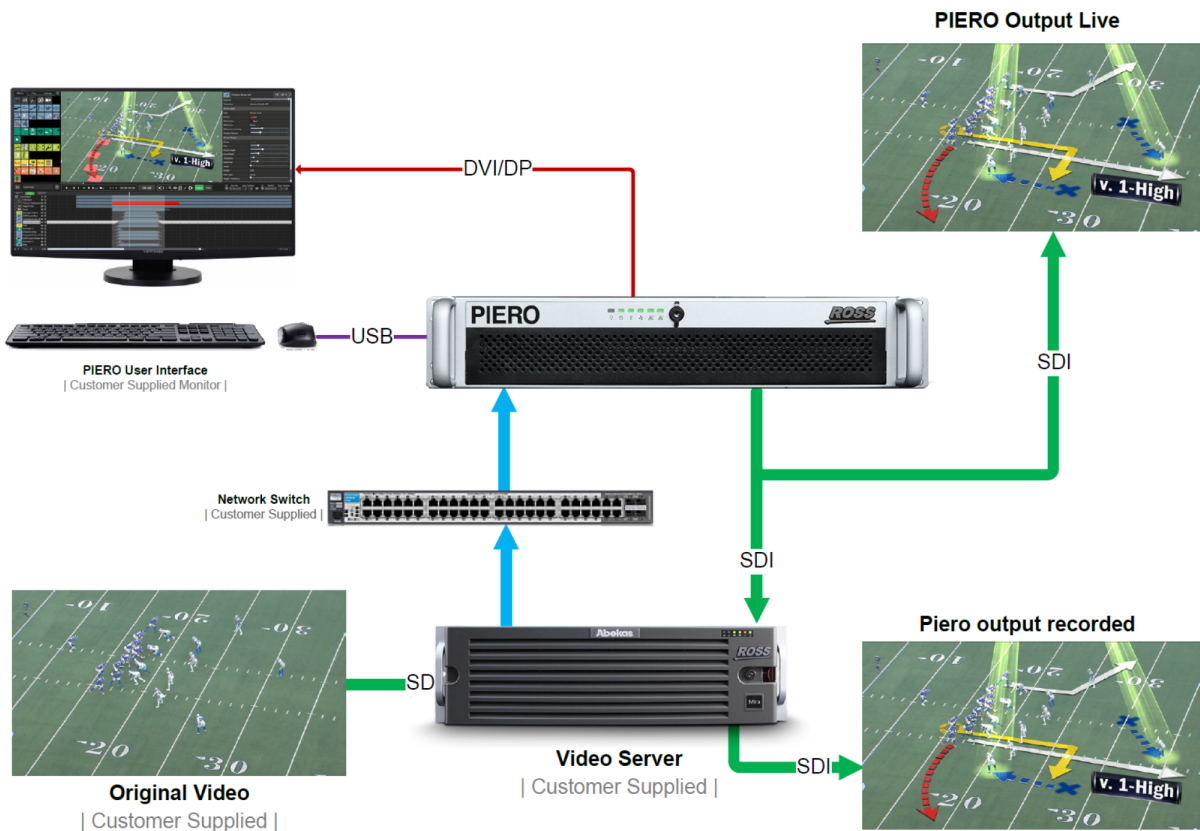

Operation Overview - FILE IN, SDI OUT

## File In, File Out

- Get clips from anywhere and send finished clips (video files) to anywhere including replay servers and MAMs.
- Watch folder setup gives the PIERO Operator easy access to a library of clips over a network.
  - ★ FTP or SAMBA can be used as part of this setup, but files should not be edited directly from a remote mount.
- May require transcoding on the record and replay server.
- A contour jog wheel can be used with PIERO for precise control when working with File In items.
- Extensive codec library list in section Video Codecs Supported in PIERO.

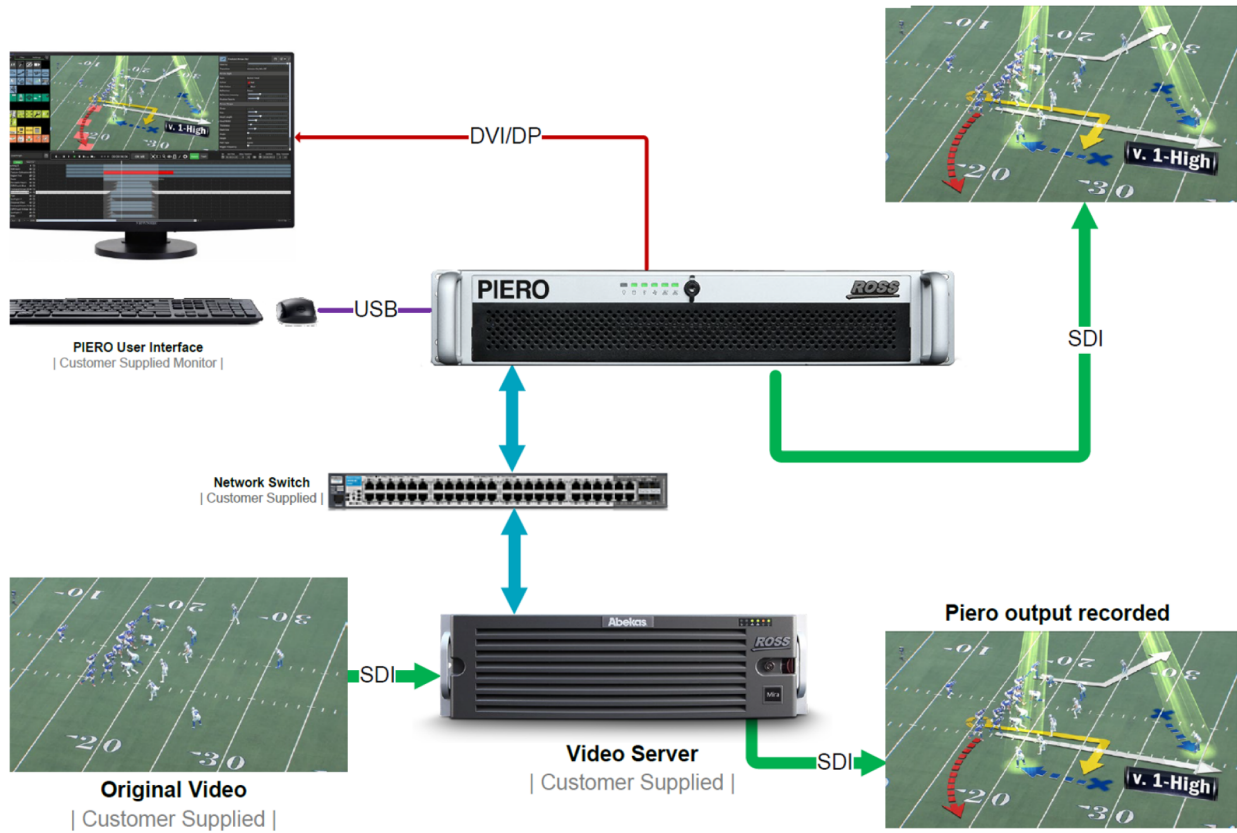

Operation Overview - File In, File Out

## PIERO Touch Mode

- Presenters can take control via Ross Video iPad app or Ross Video Windows Touch App.
- Presenters can draw new telestrations or alter existing telestrations.
- Presenters can shuttle and jog footage.

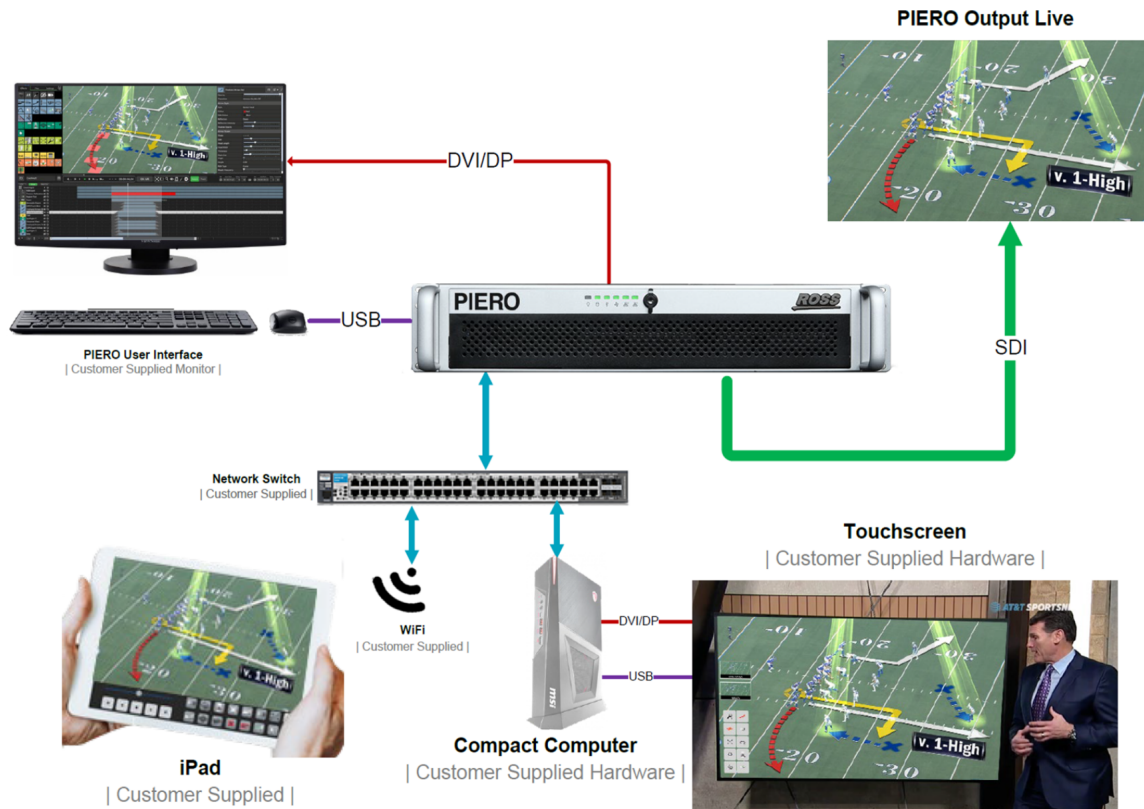

Operation Overview - PIERO Touch Mode

## PIERO Live Presentation

- First Down Line, Line of Scrimmage, Red Zone, Logos, etc. over live cameras.
- Internal chroma key.
- Optional multiple sporting field camera calibration models.
- Some functionality can be automated via scoreboard feeds.
- Latency is about 5-7 frames.
- XPression is optional for use with PIERO Live Presentation.

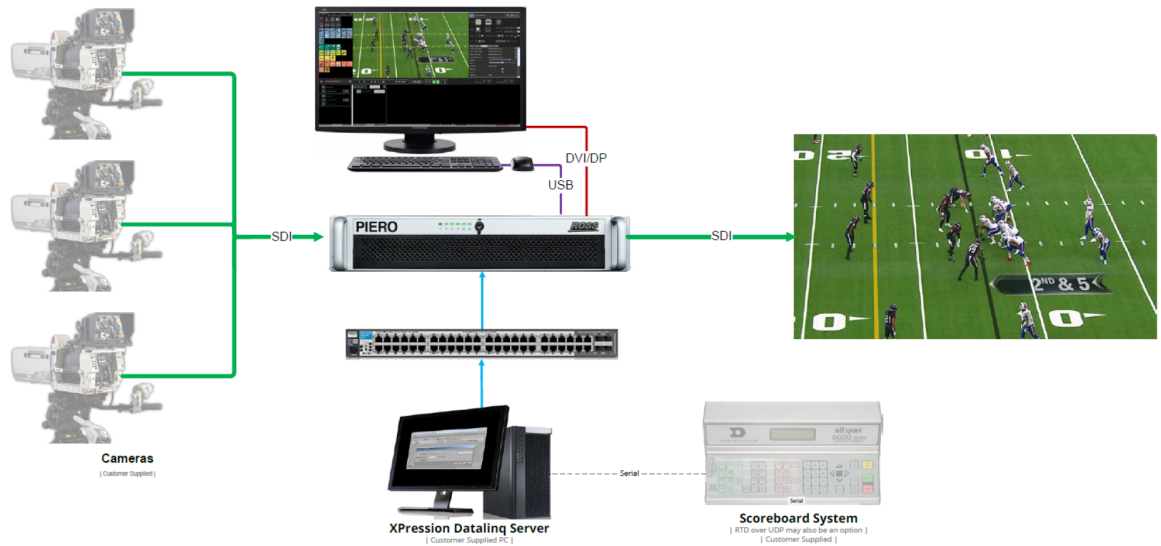

*Operation Overview - PIERO Live Presentation*

## License Updating

To ensure your PIERO software remains up-to-date with the latest licensing terms and features, it connects to the PIERO License Server to refresh your license information. This section outlines the network requirements for enabling automatic license updates, specifically focusing on allowing outgoing connections on port 9000 through your firewall.

### Updating the PIERO License

The **PIERO License Tool** includes an **Update** button that lets you refresh your license, ensuring it's updated with the latest sports, expiry dates, and related details. This update connects to the PIERO License Server via the Internet, using a TCP connection on port 9000. To enable this, please ensure your organization's firewall does not block this outgoing connection.

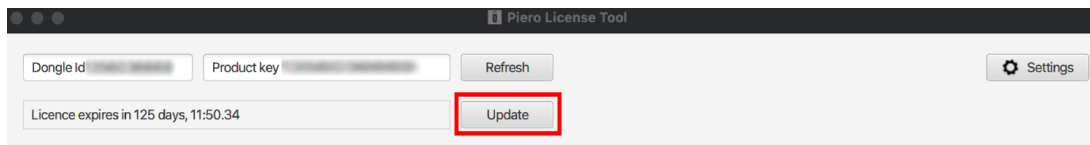

*PIERO License Tool - Update Button*

### Floatable Software License Updates

If you are using a floatable software license, the PIERO Launcher will automatically connect to the PIERO License Server upon startup to refresh your license. This automatic update also requires a TCP connection on port 9000. To benefit from this feature, ensure your organization's firewall permits outgoing TCP connections on port 9000.

### Updating an Offline Dongle

If your PIERO system is not connected to the internet, you can still update the licensing dongle using an Internet-facing Windows machine. This process involves temporarily transferring the dongle to a Windows computer that has internet access and the necessary Windows PIERO License Tool to perform the update.

Before you get started, ensure you have the Windows Piero License Tool on the Windows computer. If you do not have the Windows Piero License Tool, please contact Ross Video Technical Support.

#### To update an offline dongle:

1. Safely remove the dongle from the PIERO system.
2. Insert the dongle into a Windows computer that has internet access.
3. On the Windows computer, open the Windows **Piero License Tool**.
4. In the **Piero License Tool**, select **Refresh**.

The tool will connect to the License Server and refresh the dongle with the latest license information (see the [Updating the PIERO License](#) section for more details).

5. Once the refresh is complete, select **Update**.
6. Once the update is complete, safely remove the dongle from the Windows computer.
7. Reinsert the dongle back into the original PIERO system.

The system should now recognize the updated license information.

# PIEROTouch

PIERO streams its video output to a self-contained application running on a PC connected to the touch screen. Ross Video does not provide the PC or the touch screen. It is often cheaper and faster to order the touch screen that suits a production or re-use what is already deployed rather than buying a complete solution through PIERO.

The PIERO Touch Application should run on a PC running Windows 7, 8, or 10. For optimal performance, a stable and high-speed network connection between the PIERO machine and the Windows PC is essential, as the application relies on this connection to receive the HD video stream and send commands. We recommend using gigabit Ethernet networking.

## Minimum Windows PC System Requirements

**Processor:** i7 (6th generation or newer) 2.6 GHz or higher

**RAM:** 8 GB or more

**Ethernet:** Gigabit

**Graphics Card:** Discrete NVIDIA or AMD GPU

**OS:** Windows 7, 8, or 10

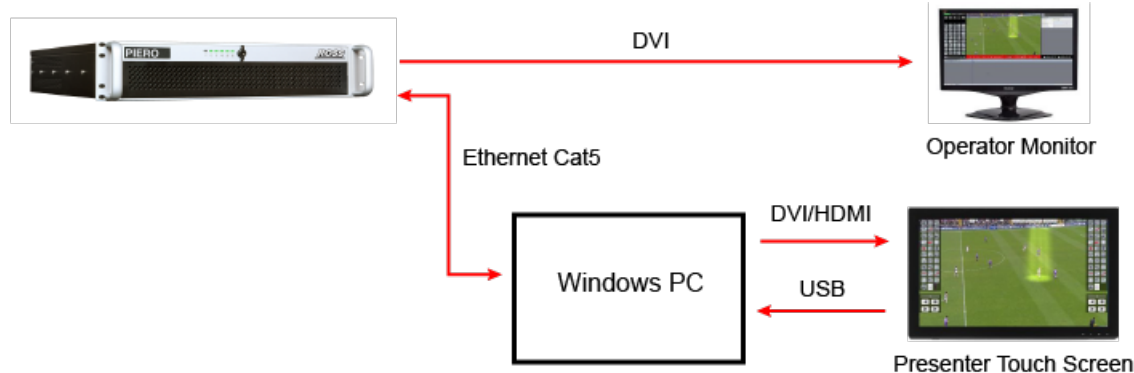

### *PIERO Touch Connection Diagram*

This solution provides:

- Compatibility with all Windows touch screens.
- Easy extension with a Cat5 cable.
- Customization possibilities and full screen operation.
- Monitoring of the effects on the PIERO timeline while on air.

# Installation

PIERO Touch can be run on a Windows PC or a Mac.

## To install PIERO Touch on a Windows PC:

1. Download the PIERO Touch installation file (**PIEROTouch-X.X.exe**).
2. Run the installer.

If you see a warning message from **Microsoft Defender SmartScreen**, select **More info** and **Run anyway**.

3. Follow the instructions in the installation wizard.

## To run PIERO Touch:

- Select the desktop icon or find it in the **Start** menu.

The first time you run PIERO Touch, a folder named **PieroTouch** will be created in your Windows home folder (**C:\Users\\PieroTouch**).

This directory stores your settings and layouts. If an earlier version of PIERO Touch was already installed, then the **PieroTouch** directory will already exist, and this will be used by the new version.

## To uninstall PIERO Touch:

1. Select the Windows **Start** icon and start typing "settings".
2. In **Windows Settings**, select **Apps**.
3. Scroll down the list and select the PIERO Touch application.
4. Then select **Uninstall**.

Note that uninstalling will not remove the **PieroTouch** directory in your home directory.

If you had an older version of PIERO Touch already installed (prior to version 1.6) it will have been placed in the **PieroTouch** directory in your home directory, in a folder called either **PieroTouchApp** or **PieroTouch**. If you no longer need access to the older version of PIERO Touch, this folder can be deleted.

## To install PIERO Touch on a Mac:

1. Download the PIERO Touch installation file (**PieroTouch-1.6.dmg**).
2. Open the **.DMG** file.
3. Drag the PIERO Touch icon onto the **Applications** folder icon in the **DMG** window.

When you first run PIERO Touch, a folder named **PieroTouch** will be created in your Documents folder (**/Users/<username>/Documents/PieroTouch**).

This folder stores your settings and layouts. If an earlier version of PIERO Touch was already installed, then the **PieroTouch** folder will already exist, and this will be used by the new version.

## To run PIERO Touch on a Mac:

- Find and select the application in the **Applications** folder or use **Spotlight Search**.

**To uninstall PIERO Touch on a Mac:**

- Delete PIERO Touch from your **Applications** folder.
  - ★ Uninstalling will not remove the **PieroTouch** directory in your **Documents** folder.

# Connecting to PIERO

When PIERO Touch is started it will automatically try to connect to the PIERO system it was last used with. If this is the first time it is being run or if the PIERO system cannot be found then the connection dialog will be shown:



*PIERO Touch Connection Dialog*

### To connect to PIERO:

1. On a Windows PC, choose a PIERO system from the list shown or enter its network IP address in the **Piero IP address** field at the top.

**OR**

On a Mac, if PIERO Touch and PIERO are running on the same computer, select **This computer** from the list.

2. Then press **Connect**.

PIERO systems will appear in the connection dialog list if the **Discoverable in Touch** checkbox is ticked in the PIERO **Settings > Touch** tab:

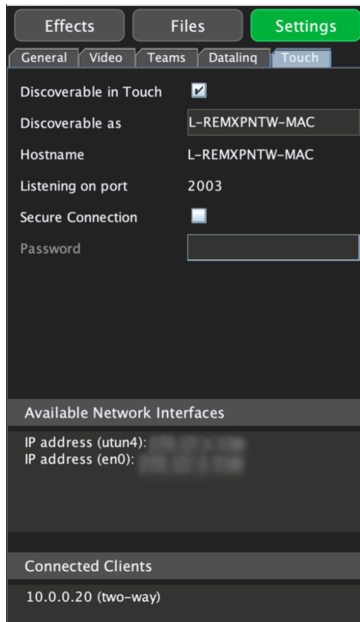

*PIERO Settings - Touch Tab*

The **Remote** tab also shows the IP address of the PIERO system. This can be entered directly into the **PIERO Touch Connection** dialog if the PIERO system does not appear in the discoverable list.

## Switching Between ON AIR and EDIT Mode

PIERO Touch has two modes:

- **ON AIR** mode is used to go on air with PIERO.
- **EDIT** mode is used to configure the layouts, buttons, and video panels.

**To switch between the two modes:**

- Press **Ctrl+E** (**Command+E** on a Mac) on the keyboard or select the checkbox at the bottom-left of the screen.

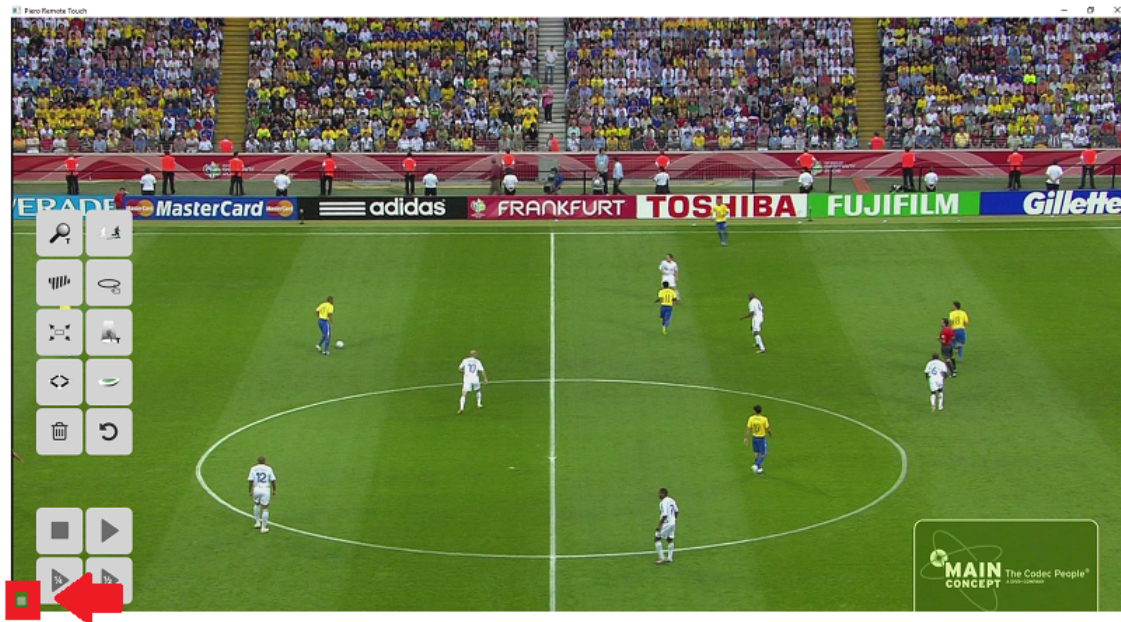

*ON AIR/ EDIT Checkbox (Bottom-left Corner)*

## Control Panel

When in **EDIT** mode you can configure PIERO Touch using the floating control panel available inside the PIERO Touch window.

Additionally, you can drag the title bar of the control panel to reposition it on the screen.

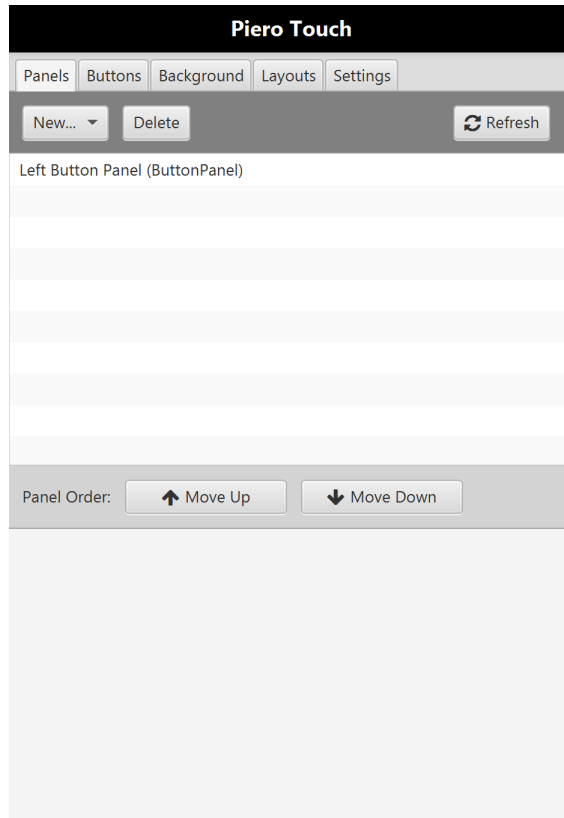

### *PIERO Touch Control Panel*

The following topics are discussed in this section:

[Panels Tab](#) 

[Buttons Tab](#) 

[Background Tab](#) 

[Layouts Tab](#) 

[Settings Tab](#) 

## Panels Tab

The PIERO Touch user interface consists of a number of panels of different types, described below. You create a touch user interface using a selection of these panels in a fully customizable layout.

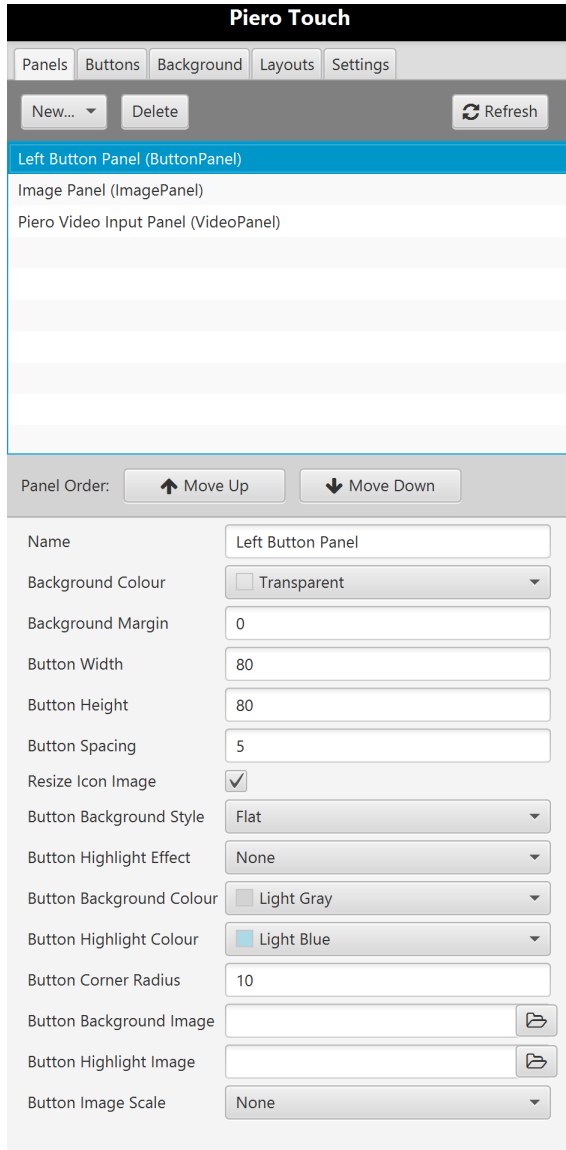

### Panels Tab

#### • Button Panel

Contains effect and VTR control buttons with customizable button width, height and spacing. There are four options for button background style, along with options for the "highlight" style which is used when the button is pressed or selected. When choosing colors with the color picker, you can choose to have "no colour" by selecting **Custom Color** and setting the **Opacity** to zero. The button icons can be customized using an **icon set** (see [Buttons tab](#) <sup>32</sup>).

#### • PIERO Video Input Panel

Displays the PIERO video output. Used when the PIERO video output is not being used as the full screen background of the touch screen. This is the only panel that responds to touch input for adding effects to the video.

- **NDI Video Input Panel**

Displays an NDI video output, selected using the NDI Source option on the property sheet. This can be used for showing NDI sources other than the PIERO output. This panel does not respond to touch input.

- **Image Panel**

Shows a still image for branding, as a background etc. (JPEG, PNG, GIF and BMP formats are supported).

- **Movie Panel**

Plays a looping movie file (H.264 files ending with .mp4 or .m4v).

- **EVS Clip Panel**

Shows buttons that will cause PIERO to load an EVS clip (see also PIERO Stack Panel).

**Button 1** will load the clip given in the PIERO Settings panel under **First EVS Clip ID**.

**Button 2** will load the next clip in order on the EVS, and so on for the other buttons.

★ Alternatively, you can load EVS clips by configuring PIERO to automatically load a clip when a stack/project is loaded. This requires the stack/project name to begin with the EVS clip ID and the **Auto-load EVS Clip** option to be enabled in the PIERO settings.

- **PIERO Clip Panel**

Shows thumbnails for jumping between the clips defined within the current PIERO stack.

- **PIERO Stack Panel**

Shows thumbnails for loading PIERO stacks (only stacks whose names end with the suffix set in the Settings tab will be shown). Stack thumbnails are chosen in PIERO using the camera button next to the stack name.

★ Stack is an alternate term for a PIERO project.

- **VTR Shuttle Panel**

A variable speed shuttle control for moving forwards or backwards through the current video

- **VTR Speed panel**

Allows you to adjust video playback speed, from 0 to 100% of normal speed. Additionally, tapping the control knob will start and stop the playback.

- **Player Caption Panel**

Shows player names on buttons that will create a Caption Track effect for the player (only shows players that are selected in the Teams tab under the PIERO Settings tab).

### To edit the layout of the panels:

1. In the **Piero Touch** window, select the **Panels** tab.
2. From the list of panels, select the panel you want to move or re-size.  
A red box with handles appears around the selected panel.
3. Use the handles to resize the panel or click and drag to reposition it.
4. Adjust panel size as needed, ensuring they do not obstruct areas of the PIERO video panel that must respond to touches.

### **To delete a panel:**

1. In the **Piero Touch** window, select the **Panels** tab.
2. From the list of panels, select the panel you want to delete and click the **Delete** button.

### **To edit panel properties:**

1. In the **Piero Touch** window, select the **Panels** tab.
2. From the list of panels, select the panel you want to modify.  
The properties available to modify are displayed below the list of panels.
3. Use the panel properties to modify the selected panel.
4. Use the **Move Up** and **Move Down** buttons to change the order of panels in the list.

★ If you are placing panels on top of each other be aware that panels at the bottom of the list appear on top of panels at the top of the list.

## Buttons Tab

The **Buttons** tab lists all the available Touch effects and presets (retrieved from the PIERO machine) along with the VTR control buttons.

Create at least one button panel to contain the buttons.

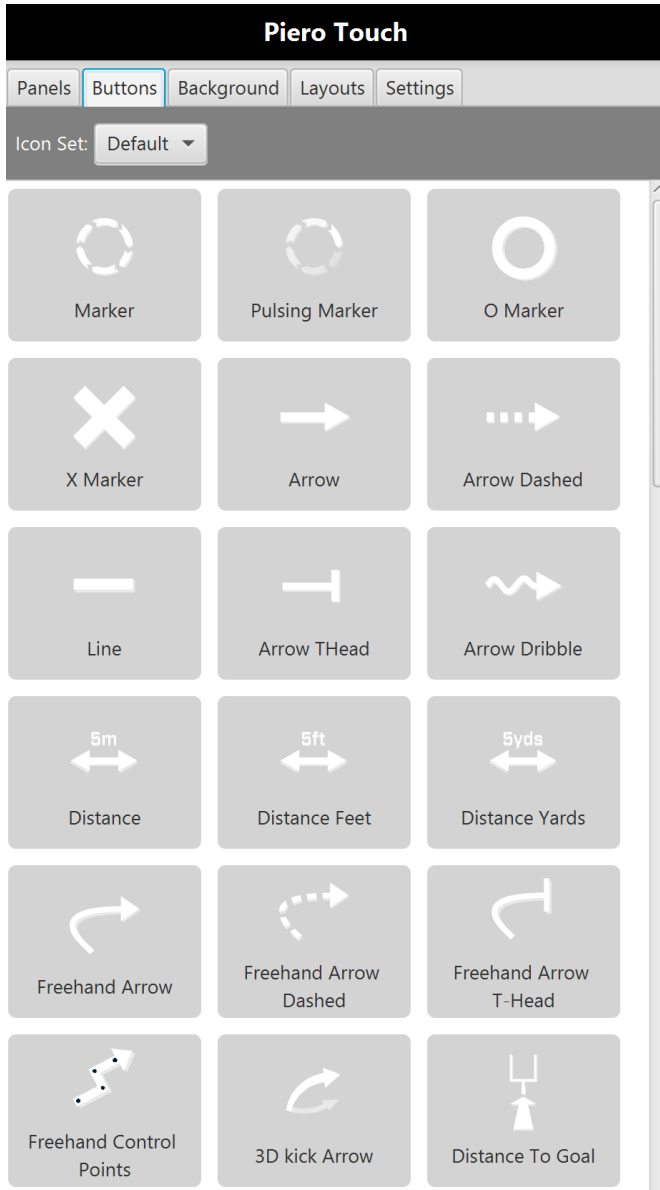

### Buttons Tab

#### To add buttons to the button panel:

1. Select the **Buttons** tab.
2. From the button panel, drag a button to an open slot on the button panel.

The button is added to the button panel.

### To remove a button from a button panel:

1. Select the **Buttons** tab.
2. From the button panel, drag the button you want to remove and drop it anywhere outside the panel.  
The button is removed from the button panel.

### To customize the button icons:

1. From the **Icon Set** drop-down, select **Edit Icon Sets**.

The **Edit Icon Sets** window opens.

★ An icon set allows you to use your own icon images to replace the default PIERO icons. You can define several icon sets, but only one can be in use at a time.

2. Select **New** to create a new icon set.

A list of the current Touch effects appears.

3. Select the folder icon next to an effect to choose an image file for its icon.

Alternatively, you can drag and drop a file from the File Explorer onto the appropriate row.

4. Select the **X** button next to a custom icon to reset the icon back to the PIERO default.

5. Select the **Fixed Color** checkbox at the end of an icon row to maintain the colors of your custom icon.

Some Touch effect icons are automatically colored based on the PIERO home and away team color settings.

6. Select **Rename**.

The **Confirmation** dialog opens.

7. In the **Rename icon set** field, enter a name for your layout and select **OK**.

The name of the current icon set is saved with the layout.

### To select an icon set:

- In the **Buttons** tab, from the **Icon Set** drop-down, select an icon set.

## Background Tab

The full screen background of the touch screen can be set to a number of different things: PIERO video input, NDI video input, solid colour, image or movie. The default is to have the video from PIERO in the background.

The **Standby** background is an optional background that covers the entire screen when PIERO is not in Touch mode. You can see the **Standby** background when PIERO is in **Analysis** mode. When you put PIERO into Touch mode, the **Standby** background disappears.

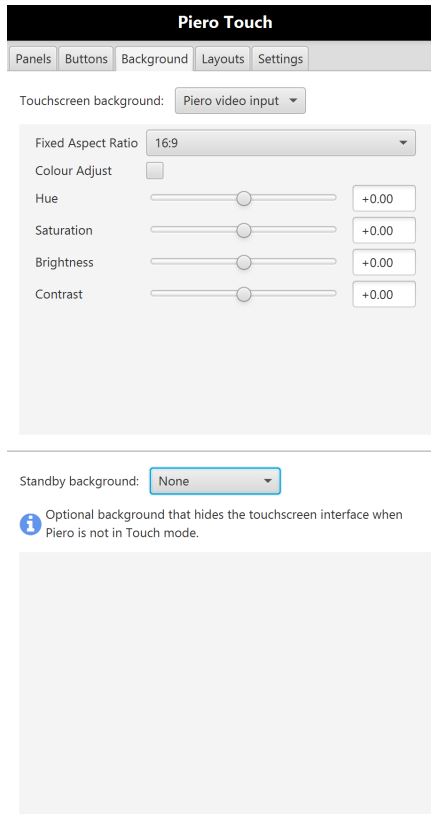

### *Piero Touch - Background Tab*

#### **To change the background:**

1. In the **Background** tab, from the **Touchscreen background** drop-down, select a background type.

The properties that can be adjusted appear.

★ **Note:** the properties available to configure change depending on the background selected.

2. Adjust the properties of the background as necessary.
3. If you don't have the PIERO video input as the background, in the **Panels** tab, add a **PIERO Video Input Panel** so that the PIERO video can be seen.

When using a video file as a background, the file should be in the following format:

MPEG-4 H.264/AVC codec with .mp4 or .m4v file extension

## Layouts Tab

The layouts are saved in the layouts folder in **C:\Users\\PIEROTouch**.

When the Touch application starts, it tries to load the last used layout. If there is no such layout, it will attempt to load the default layout.

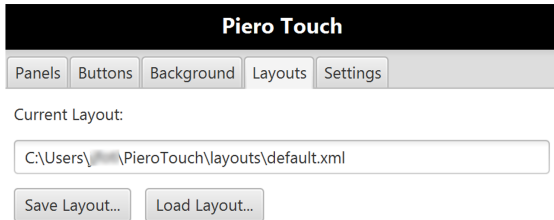

### *Piero Touch - Layouts Tab*

#### **To load a layout:**

1. Select the **Load Layout** button.
2. In the **Load Layout** window, select the layout you want and select **Open**.

#### **To save a layout:**

1. Select the **Save Layout** button.
2. In the **Save Layout** window, select the layout you want to save and select **Save**.

## Settings Tab

In the **Settings** tab, you can quit the PIERO Touch application, disconnect from the main PIERO application, and configure how you want the PIERO Touch application to behave.

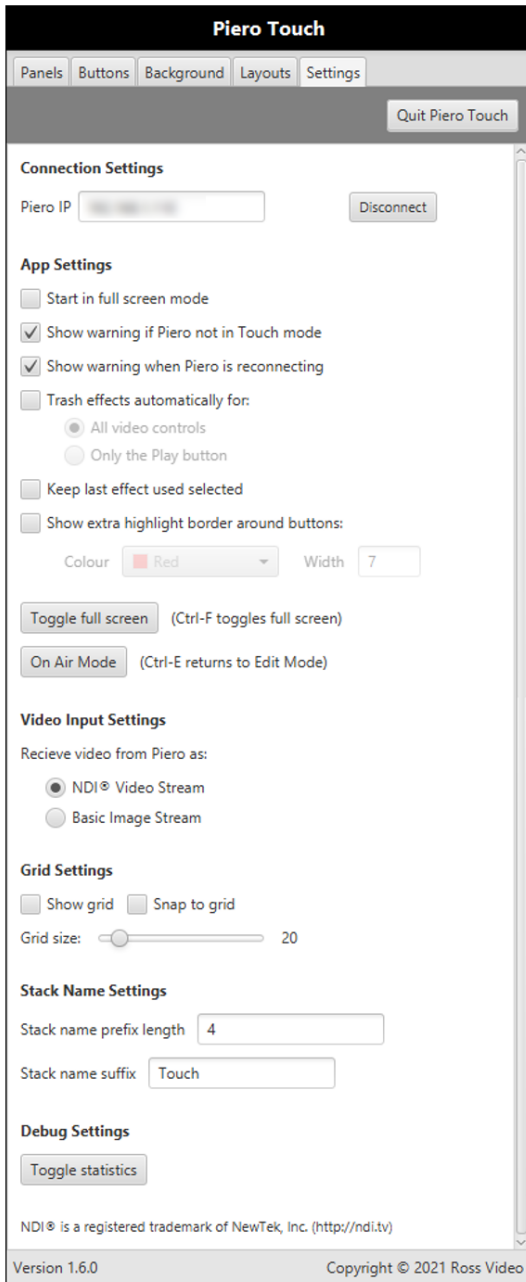

### Settings Tab

The settings are described in the table below:

<b>Quit PIERO Touch</b>	<p>Press the <b>Quit PIERO Touch</b> button to quit the application.</p> <p>You can also quit the application using the close button of the window, if you are not in full screen mode, or by pressing <b>Alt+F4 (Command+Q)</b> on Mac) on the keyboard.</p> <p>If you want to save your current layout you should do so before quitting.</p>
<b>PIERO IP</b>	The IP address of the PIERO PC.
<b>Connect and Disconnect</b>	Connect and disconnect PIERO Touch from the PIERO PC.
<b>Start in full screen mode</b>	Makes PIERO Touch automatically go into full screen mode when it starts.
<b>Show warning if PIERO not in Touch mode</b>	Shows a warning message at the bottom of the touch screen when PIERO is not in Touch mode.
<b>Show warning when PIERO is reconnecting</b>	Shows a warning message at the bottom of the touch screen when PIERO Touch is attempting to automatically connect to PIERO, if PIERO stops running.
<b>Trash effects automatically for</b>	<p>When selected, effects will automatically be deleted when you start the video playing after it has been paused.</p> <p>You can choose whether the automatic deletion happens for all video controls or only the <b>Play</b> button (this allows you, for example, to use frame forward/back without effects getting deleted).</p>
<b>Keep last effect used selected</b>	The last effect button used remains highlighted.
<b>Show extra highlight border around buttons</b>	Use this for additional highlighting of the last effect used.
<b>Toggle full screen</b>	<p>Normal use is full screen mode, with no visible window borders.</p> <p>To switch between windowed and full screen mode press the <b>Toggle full screen</b> button or <b>Ctrl+F (Command+F)</b> on Mac) on the keyboard.</p>
<b>On Air Mode</b>	<p>Press the <b>ON AIR</b> mode button to go into on air mode.</p> <p>The floating control panel window will disappear and the effect buttons and VTR controls will become active.</p> <p>To get back to <b>EDIT</b> mode press <b>Ctrl+E (Command+E)</b> on Mac) on the keyboard or select the checkbox in the bottom-left corner of the screen.</p>

<p><b>Video Input Settings</b></p>	<p>Controls how PIERO Touch receives the video output stream from PIERO.</p> <p>There are two options:</p> <p><b>NDI® Video Stream:</b> Starting with PIERO version 16.2, the video output is available as an NDI video stream. As this can offer better video quality, this is preferred and is now the default option for PIERO Touch 1.6. (NDI is a registered trademark of NewTek Inc. For more information visit (<a href="http://ndi.tv">http://ndi.tv</a>).</p> <p><b>Basic Image Stream:</b> Prior to PIERO version 16.2, the basic image stream was the only way that the PIERO output video could be sent to PIERO Touch. If you are using an older version of PIERO (version 16.1 or earlier) you must select <b>Basic Image Stream for PIERO Touch</b> to receive the PIERO video output.</p>
<p><b>Grid Settings</b></p>	<p>To help align panels, select the <b>Show grid</b> and <b>Snap to grid</b> checkboxes.</p> <p>Moving or resizing of panels will snap to the grid.</p> <p>You can use the <b>Grid size</b> slider to change the size of the grid.</p>
<p><b>Stack Name Settings</b></p>	<p>These settings affect stack thumbnails appearing in the PIERO Stack panel type.</p> <ul style="list-style-type: none"> <li>• The <b>Stack name prefix length</b> is used to remove a number of characters from the start of the stack name.</li> </ul> <p>This is useful if stacks are named with the EVS clip ID as the first four characters. Setting <b>Stack name prefix length</b> to 4 means the EVS clip ID is not shown as part of the stack name on the touch screen.</p> <ul style="list-style-type: none"> <li>• The <b>Stack name suffix</b> controls which stacks are shown in the <b>PIERO Stack</b> panel.</li> </ul> <p>Only stacks whose names end exactly with the suffix are shown. The default setting of Touch means that only stacks whose names end with <b>Touch</b> are shown. The suffix is removed from the stack name before it is shown on the touch screen.</p>
<p><b>Debug Settings</b></p>	<p>Select the <b>Toggle statistics</b> button to hide or show the statistics window.</p> <p>This provides information about the video streams being received by PIERO Touch. If you see dropped frames being reported, this suggests that some part of the system is not fast enough, either the network connection or the computer running PIERO Touch.</p>

# Virtual Presenter



*Virtual Presenter*

To use the Virtual Presenter Effect it is necessary to connect the feed from the Green Screen Studio camera to PIERO's 2nd SDI Input (SDI In B).

Select Broadcast or Broadcast (Dual Input) in the launcher to use the Virtual Presenter Effect.

## SDI Connections

The SDI connections with a Virtual Presenter are as follows:

### M8 2RU Systems (AJA Corvid 88 Card)

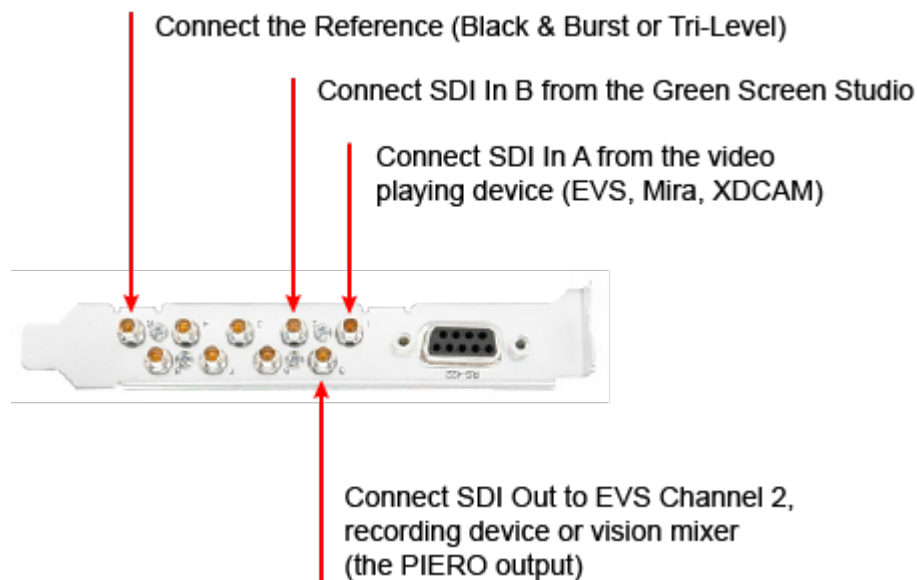

*SDI Connections - AJA Corvid 88*

# Keyboard Language Layout

In newer versions of Linux, the keyboard language layout is referred to as an input source.

## To add a new input source (keyboard language layout):

1. Select **Applications > System Tools > Settings > Region & Language**.

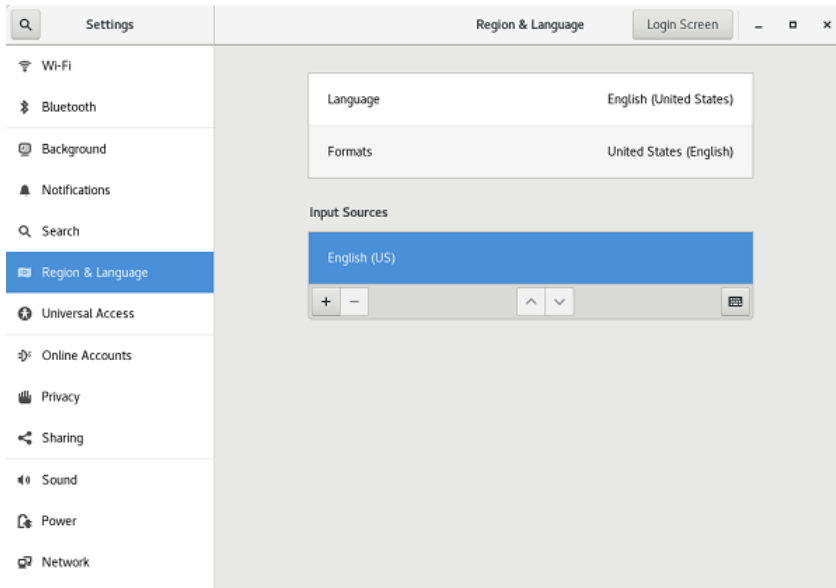

*Region & Language Settings*

2. Under **Input Sources**, select the + sign to open the **Add an Input Source** window.



*Add an Input Source*

3. Select the input source (keyboard layout) you need for your country and select **Add**.

If you don't see your country, select the 3 dots at the bottom of the list to access the **Search** feature and find your country.

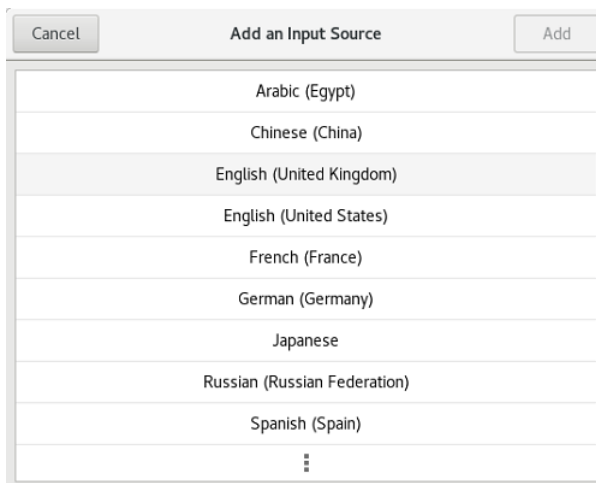

*Add an Input Source*

4. In the main window, select your input source and then select the **Options** button.
5. In the **Input Source Options** window, select one of the following options:
  - Use the same source for all windows
  - Allow different sources for each window.
6. Select the **X** in the top-right corner to close the **Input Source Options** window.
7. Select the keyboard symbol in the bottom-right corner of the **Input Sources** section to view the selected keyboard layout.



*Keyboard Layout*

8. When you have finished adding/selecting input sources (keyboard layouts), select the **X** in the top-right corner to close the **Region & Language** window.

**To remove an input source:**

- Select the input source you want to delete and select the **Remove Input Source** symbol.



*Remove Input Source*

# Network Setup

Follow this procedure to enable the network on the PIERO PC. Administrator privileges are required. Protect the login details of the root account as it can cause damage.

## To activate the network port:

1. On the PIERO desktop, select **Applications > System Tools > Settings > Network** to launch the **Network Connections** program.

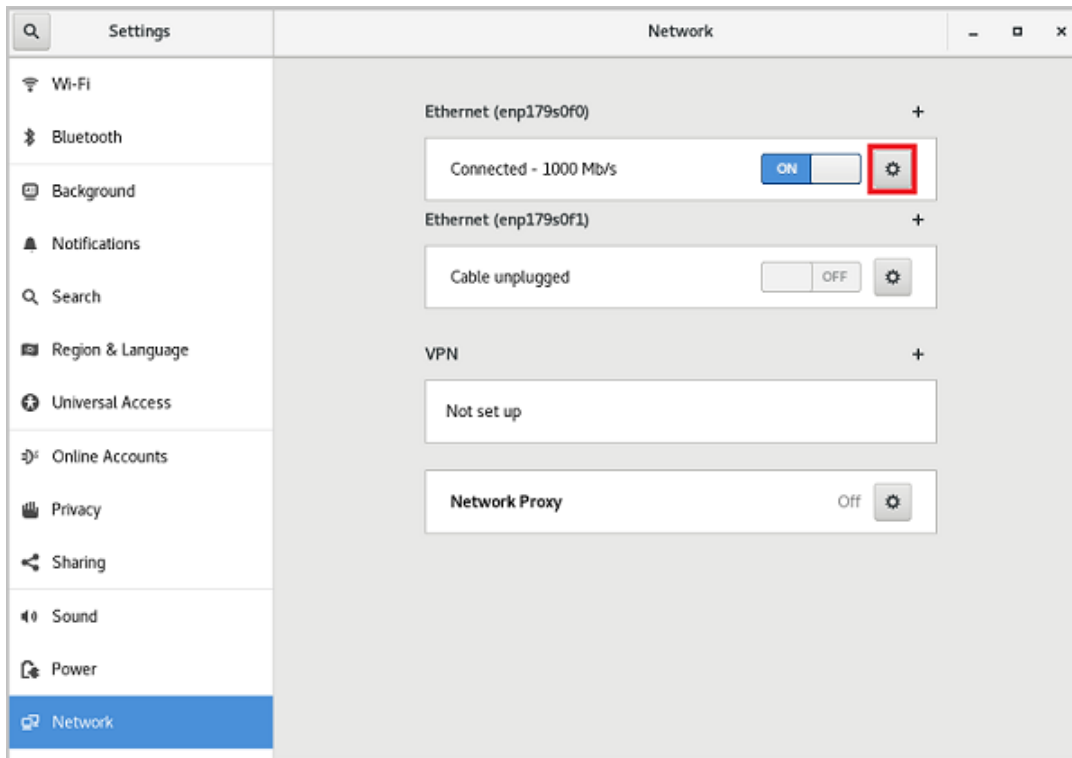

### *Network Connections*

2. Select the connection to configure (usually eth0 or eth1) then select the **Settings** button beside the connection.

Note that some PIERO laptops may present their Wi-Fi network card as **wlan0**. This cannot be used for the iPad.

3. In the **Details** tab, select the **Connect automatically** checkbox.

Cancel Wired Apply

**Details** Identity IPv4 IPv6 Security

Link speed 1000 Mb/s

IPv4 Address 10.62.134.208

IPv6 Address fe80::70e4:2033:8bc3:9493

Hardware Address 0C:9D:92:C5:39:BC

Default Route 10.62.134.1

DNS 10.0.0.70 10.0.0.69

Connect automatically

Make available to other users

Restrict background data usage  
Appropriate for connections that have data charges or limits.

Remove Connection Profile

#### *Ethernet Settings*

4. In the **IPv4** tab, leave the default **DHCP** setting or specify a **Static IP** address manually.  
We recommend using a **Static IP** address for the iPad if possible.

Cancel Wired Apply

**Details** Identity **IPv4** IPv6 Security

**IPv4 Method**

Automatic (DHCP)  Link-Local Only

Manual  Disable

**DNS** Automatic ON

Separate IP addresses with commas

**Routes** Automatic ON

Address	Netmask	Gateway	Metric
<input type="text"/>	<input type="text"/>	<input type="text"/>	<input type="text"/>

Use this connection only for resources on its network

#### *IPv4 Settings*

5. Select **Apply**.

# Updating the Hosts File

Slowing down the boot-up, log-in and application startup time will prevent time-out issues.

## To update the Hosts file:

1. On the PIERO PC, select **Applications > System Tools > Terminal** to open a terminal.
2. Type `su` and press **Enter**.

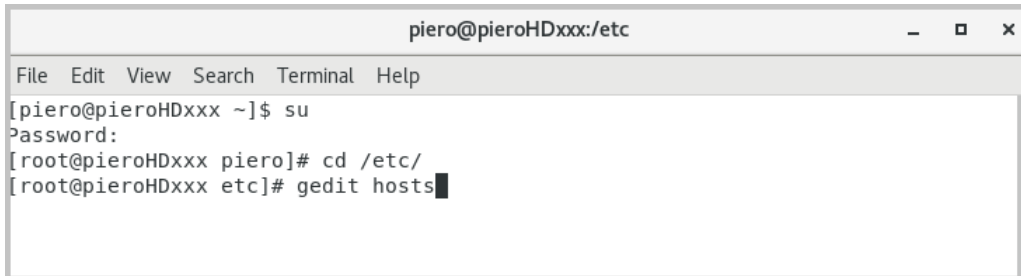

```
piero@pieroHDxxx:/etc
File Edit View Search Terminal Help
[piero@pieroHDxxx ~]$ su
Password:
[root@pieroHDxxx piero]# cd /etc/
[root@pieroHDxxx etc]# gedit hosts
```

*Hosts File Terminal Entries*

3. Enter the password 117dalstonSUPERstore (on linux the password is not displayed as you type) and press **Enter**.
4. Type `cd /etc/` and press **Enter**.
5. Type `gedit hosts` and press **Enter**.

The **host /etc - gedit** window opens.

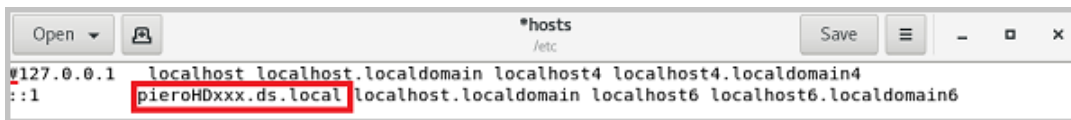

```
*hosts
/etc
Save
#127.0.0.1 localhost localhost.localdomain localhost4 localhost4.localdomain4
::1 pieroHDxxx.ds.local localhost.localdomain localhost6 localhost6.localdomain6
```

*Hosts (/etc) - gedit*

6. In the **hosts /etc - gedit** window, comment the loopback (127.0.0.1) line (first line) by adding a **#** sign at the beginning of the line.
7. In the second line, change the machine's name to your PIERO machine.

The machine name is visible in the command prompt or can be found in **System > About This Computer**.

- For desktops type `HDxxx`, where **xx** is the machine's number, e.g., `::1 PIEROhd99.ds.redbeemediat.net PIEROhd99 localhost.localdomain local host.`
- For laptops type `laptopXX`, where **XX** is the machine's number. e.g., `::1 PIEROlaptop02.ds.redbeemedia.net PIEROlaptop02 localhost.localdomain local host.`

8. Select **Save** and **Quit**.
9. Close the terminal.
10. Restart the machine to acknowledge the new configuration.

## Firewall

To ensure PIERO can access Opta data or be controlled via a touch screen or iPad, make sure to remove firewall restrictions on the following ports:

### **Opta**

Port: 80 (53 for DNS)

### **STATS**

Port: 80

### **iPad**

Port: 2003

### **PIERO Touch**

Port: 2003

# ST 2110 Setup and Configuration

ST 2110 video is supported in PIERO v20.0 (and later) on systems equipped with a Matrox DSX LE5 LP D25 video card. Starting with PIERO v20.2, timecode input is supported via an ancillary data stream, allowing ST 2110 to be used in both Live and Analysis modes. Currently, audio passthrough and sound effects are not supported.

Configuration of the ST 2110 senders and receivers can be done either by editing JSON settings files or via NMOS IS-05 connection management. Configuring the ST 2059 reference used by PIERO must be done by editing JSON settings files.

The DSX LE5 LP D25 card has two SFP28 cages, A (primary) and B (redundant), capable of 10GbE or 25GbE. Only SFP A is used for video input and output, while SFP B is used only for ST 2022-7 redundancy.

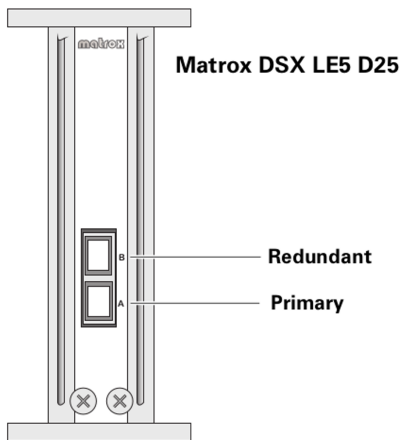

Matrox DSX LE5 D25 - SFP Cages

## Network Adapter Configuration

Use the **Network** section of the **Settings** application to configure the IPv4 addresses of the two SFP connectors. Refer to the [Network Setup](#) section for information about network configuration. These IP addresses are designated for use on the "media LAN" to manage media flows.

★ In the network settings, SFP A will be listed as **mvkEthernet0** and SFP B as **mvkEthernet1**.

In addition to the IP addresses assigned to the SFPs in network settings, a second IP address is needed for use by the ST 2059 engine for each SFP. These IP addresses are set in the ST 2059 settings file for each SFP. For additional information, see the [ST 2059 Genlock Settings](#) section.

The MAC addresses associated with the media LAN and the ST 2059 engine for each SFP are logged in the PIERO log file during startup, as follows:

```
CONFIG : MATROX : Hardware Model: DLE5D25L/100
CONFIG : MATROX : SFP A:   Transceiver: FS, S28-AC03, s/n: C2402326830-1, version: 01
CONFIG : MATROX :   MAC: 00:20:FC:34:B4:47, ST2059 MAC: 00:20:FC:34:B4:48
CONFIG : MATROX :   IP Video In: 16, IP Video Out: 16
CONFIG : MATROX :   IP Audio In: 128, IP Audio Out: 128
CONFIG : MATROX :   IP Anc In: 32, IP Anc Out: 32
CONFIG : MATROX : SFP B:   No SFP+ transceiver detected
CONFIG : MATROX :   MAC: 00:20:FC:34:B4:49, ST2059 MAC: 00:20:FC:34:B4:4A
CONFIG : MATROX :   IP Redundancy cage.
```

## NMOS Support

NMOS support includes IS-04 and IS-05. The PIERO node and device will be registered when the system boots up. PIERO's senders and receivers will be registered when the PIERO application starts.

There is a JSON settings file provided by Matrox that can be used to configure NMOS. This file is named after the serial number of the Matrox card being used. For example:

**/opt/MatroxVideo/A123456.json**

This file can be edited to change the NMOS settings, using the Text Editor application. See the [Editing Settings Files](#) section for details on editing JSON settings files.

Options to consider include:

Option	Value
enabled	<ul style="list-style-type: none"><li>Controls whether NMOS is enabled or not.</li><li>Allowed values: true or false</li></ul>
local port	<ul style="list-style-type: none"><li>The port number on which NMOS HTTP requests will be expected.</li></ul>

The names of the NMOS node, device, senders and receivers can also be customized by editing this file.

There is an additional JSON settings file that controls whether PIERO will respond to IS-05 connection management requests. This is "true" by default. See the section "NMOS settings" later in this document for more details.

The default port used for NMOS requests is 50000, but this can be changed by editing the **local port** setting in the Matrox JSON file. The firewall on the PIERO system is pre-configured to allow incoming TCP connections on this port. If you want to use a different port for NMOS requests, you will need to add a firewall rule for the port in question. You can add a firewall rule using the graphical Firewall Configuration app.

### To add a firewall rule:

1. Run the Firewall Configuration application:
  - a. Select the **Activities** menu in the top left of your screen.  
Alternatively, you can press the **Windows** key.
  - b. Start typing `firewall` and press the **Enter** key when the **Firewall Configuration** application is highlighted.  
After entering your password, the **Firewall** window opens.

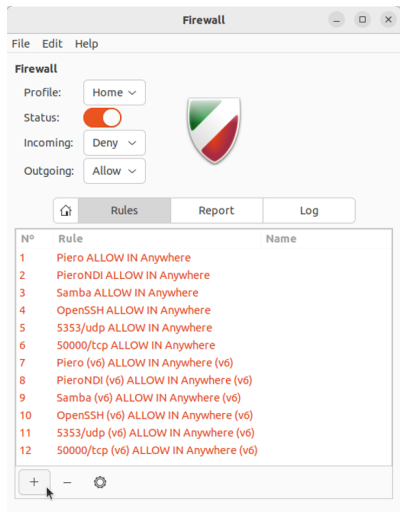

*Firewall Window*

2. Select the **Rules** tab to view the current list of firewall rules.
3. Add a new rule for the NMOS port (for example, 50001):
  - a. Press the **+** (**Plus**) button to show the **Add a Firewall Rule** dialog.

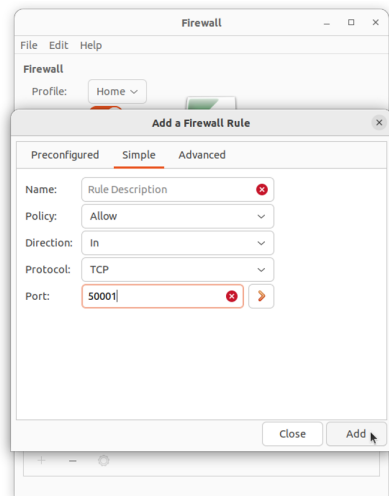

*Add a Firewall Rule Dialog*

- b. From the **Policy** drop-down, select **Allow**.
- c. From the **Direction** drop-down, select **In**.
- d. From the **Protocol** drop-down, select **TCP**.
- e. In the **Port** field, set the port number (in this case 50001).
- f. Select **Add**.

The new rule is created.

★ **Note:** An alternative way to add the new firewall rule is to run the following command in a terminal window:

**sudo ufw allow 50001/tcp**

## To remove unwanted rules:

- Select a rule from the list and press the - (**Minus**) button.

For additional help with NMOS configuration, please contact PIERO support.

## Starting PIERO

The Launcher confirms that an ST 2110 Matrox video card is installed by showing **ST 2110** at the end of the line of text that starts **Matrox video card**. If the text is red, you will need to run the PIERO Matrox Utility to reinstall the Matrox driver.

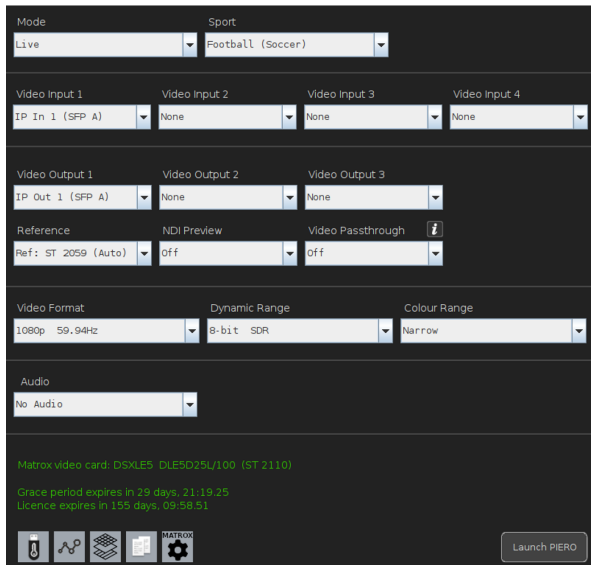

### Launcher Settings

The Launcher offers up to eight ST 2110 video inputs and eight ST 2110 video outputs. These are listed as **IP In 1-8 (SFP A)** and **IP Out 1-8 (SFP A)** in the **Video Input** and **Video Output** drop-downs. When PIERO is running, by default these will appear in NMOS as **DSXLE5 Sender IP video OUT 1-8** and **DSXLE5 Receiver IP video IN 1-8**.

★ **Note:** the number of inputs and outputs that can be used simultaneously depends on the video format and the total available bandwidth of the SFP.

The **Reference** drop-down box offers four choices for genlock over IP. The recommended default is **ST 2059 (Auto)** which will use the best available PTP source on either SFP A or SFP B. To force the system to only use one of the SFPs for PTP choose the appropriate option, either **ST 2059 (SFP A)** or **ST 2059 (SFP B)**. Choose **Internal** to not use ST 2059 genlock.

## Editing Setting Files

Configuring the video input, output, ST 2059, and PIERO-specific NMOS settings involves editing JSON settings files located in the hidden PIERO config directory. When PIERO first starts, it automatically creates the necessary settings files if they do not already exist. Quit PIERO, edit the settings files, and restart PIERO to apply the new settings.

The settings files are in the following directory, which is normally hidden:

**/home/piero/.piero\_config/st2110/**

## To access the directory:

1. From the **Places** menu, select **Home**.

A window appears.

2. In the window, select the menu button with three horizontal lines and select **Show Hidden Files**.

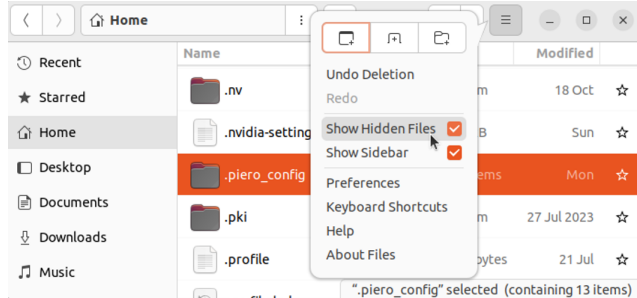

*Home Menu - Show Hidden Files Option Enabled*

3. Locate the folder named **.piero\_config** and open it by double-clicking.
4. Open the folder named **st2110**.

★ **Note:** this folder will not exist until you've started PIERO at least once.

## To edit an ST 2110 settings file:

Editing an ST 2110 settings file can be done using the built-in Text Editor app.

1. Right click on the ST 2110 file and select **Open With Text Editor**.

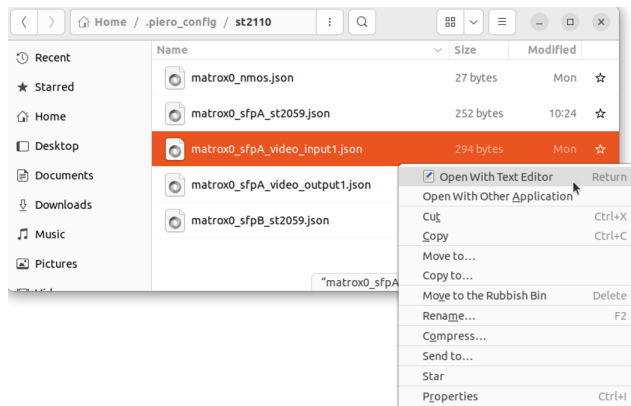

*Open With Text Editor Option*

Alternatively, you can choose **Open With Other Application**, select **View All Applications**, and then choose **Text Editor**.

The Text Editor opens.

2. Edit the settings file in the Text Editor.

3. When you have finished editing the settings, select **Save** and then close the window.

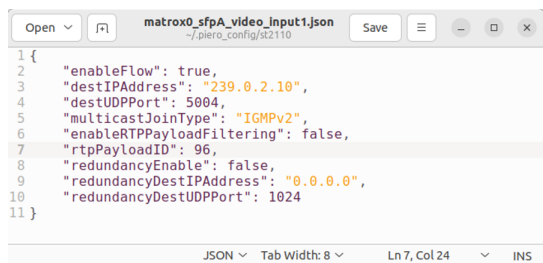

```
1 {
2   "enableFlow": true,
3   "destIPAddress": "239.0.2.10",
4   "destUDPPort": 5004,
5   "multicastJoinType": "IGMPv2",
6   "enableRTPPayloadFiltering": false,
7   "rtpPayloadID": 96,
8   "redundancyEnable": false,
9   "redundancyDestIPAddress": "0.0.0.0",
10  "redundancyDestUDPPort": 1024
11 }
```

### Text Editor

When editing the files be careful to keep the existing formatting, commas, quotation marks, etc. intact. The values you can change are to the right of the colon on each line.

If a JSON settings file is not correctly formatted, then PIERO will not be able to load it. You will see errors about this in the PIERO log file, for example a line containing the following:

*SEVERE: error reading Matrox IP video input settings from file...*

In this situation the easiest solution is to delete the file in question and restart PIERO. A new version of the settings file will be created, which can then be edited as required.

## ST 2059 Genlock Settings

There are two ST 2059 settings files, one for each SFP:

- **matrox0\_sfpA\_st2059.json**
- **matrox0\_sfpB\_st2059.json**

The options in this file are listed and described in the table below. Some can remain at their default values if they are acceptable.

Option	Value
ipAddress	<ul style="list-style-type: none"><li>• IP address for the ST 2059 engine to use (must be different from the IP address used for the media LAN that is configured using the Linux network settings).</li></ul>
ipGateway	<ul style="list-style-type: none"><li>• IP gateway address</li></ul>
ipNetmask	<ul style="list-style-type: none"><li>• IP netmask</li></ul>
dhcpEnable	<ul style="list-style-type: none"><li>• Use DHCP for the ST 2059 engine IP settings?</li><li>• Allowed values: true, false</li></ul>
clockDomainNumber	<ul style="list-style-type: none"><li>• PTP clock domain number</li></ul>
ipMode	<ul style="list-style-type: none"><li>• Communications method used for PTP.</li><li>• Allowed values:<ul style="list-style-type: none"><li>➤ "Hybrid" uses a combination of multicast and unicast (this reduces the amount of PTP network traffic).</li><li>➤ "Multicast" uses multicast only.</li></ul></li></ul>
multicastJoinType	<ul style="list-style-type: none"><li>• Which type of multicast group membership request to use.</li><li>• Allowed values: "None", "IGMPv2", "IGMPv3"</li></ul>
announceReceiptTimeout	<ul style="list-style-type: none"><li>• Number of intervals that must pass before a new leader clock is selected (can be left at the default value).</li></ul>
typeOfServiceDSCP	<ul style="list-style-type: none"><li>• Differentiated Services Code Point (can be left at the default value).</li></ul>

## Video Input Settings

There is a video input settings file for each video input, numbered from 1 to 8, for example:

### **matrox0\_sfpA\_video\_input1.json**

The options in this file are listed and described in the table below. Some can remain at their default values if they are acceptable.

Option	Value
enableFlow	<ul style="list-style-type: none"><li>• Enable this video input.</li><li>• Allowed values: true, false</li></ul>
destIPAddress	<ul style="list-style-type: none"><li>• Multicast IP address of the video flow to receive</li></ul>
destUDPPort	<ul style="list-style-type: none"><li>• UDP port number of the video flow to receive</li></ul>
multicastJoinType	<ul style="list-style-type: none"><li>• Which type of multicast group membership request to use</li><li>• Allowed values: "None", "IGMPv2", "IGMPv3"</li></ul>
enableRTPPayloadFiltering	<ul style="list-style-type: none"><li>• Filter incoming network packets using RTP payload ID?</li><li>• Allowed values: true, false</li></ul>
rtpPayloadID	<ul style="list-style-type: none"><li>• RTP payload ID to use for filtering (used by the previous option)</li></ul>
redundancyEnable	<ul style="list-style-type: none"><li>• Enable ST 2022-7 redundancy?</li><li>• Allowed values: true, false</li></ul>
redundancyDestIPAddress	<ul style="list-style-type: none"><li>• Multicast IP address of the redundancy video flow</li></ul>
redundancyDestUDPPort	<ul style="list-style-type: none"><li>• UDP port number of the redundancy video flow</li></ul>

In addition to the video input settings file, each input has an associated ancillary data input settings file, numbered from 1 to 8, for example:

### **matrox0\_sfpA\_anc\_input1.json**

The ancillary data input must be configured if timecode input is required, such as when running PIERO in Analysis mode. If timecode input is not required, the ancillary data settings file can be left at the default values.

The options in the ANC settings file are listed and described in the table below:

Option	Value
enableFlow	Enable this ancillary data input Allowed values: true, false
destIPAddress	Multicast IP address of the ancillary data flow to receive
destUDPPort	UDP port number of the ancillary data flow to receive
multicastJoinType	Which type of multicast group membership request to use Allowed values: "None", "IGMPv2", "IGMPv3"
enableRTPPayloadFiltering	Filter incoming network packets using RTP payload ID? Allowed values: true, false
rtpPayloadID	RTP payload ID to use for filtering (used by the previous option)

<b>Option</b>	<b>Value</b>
redundancyEnable	Enable ST 2022-7 redundancy? Allowed values: true, false
redundancyDestIPAddress	Multicast IP address of the redundancy ancillary data flow
redundancyDestUDPPort	UDP port number of the redundancy ancillary data flow

## Video Output Settings

There is a video output settings file for each video output, numbered from 1 to 8, for example:

### **matrox0\_sfpA\_video\_output1.json**

The options in this file are listed and described in the table below. Some can remain at their default values if they are acceptable.

Option	View
enableFlow	<ul style="list-style-type: none"><li>• Enable this video output.</li><li>• Allowed values: true, false</li></ul>
sourceUDPPort	<ul style="list-style-type: none"><li>• UDP port number of the sender – this does not need to be set by the user, but it might be set by NMOS.</li></ul>
destIPAddress	<ul style="list-style-type: none"><li>• Multicast IP address to send output flow to.</li></ul>
destUDPPort	<ul style="list-style-type: none"><li>• UDP port number to send output flow to (must be 1024 or greater).</li></ul>
rtpPayloadID	<ul style="list-style-type: none"><li>• RTP payload ID (can be left at default value).</li></ul>
redundancyEnable	<ul style="list-style-type: none"><li>• Enable ST 2022-7 redundancy?</li><li>• Allowed values: true, false</li></ul>
redundancySourceUDPPort	<ul style="list-style-type: none"><li>• Source UDP port number of the redundancy video flow – this does not need to be set by the user, but it might be set by NMOS.</li></ul>
redundancyDestIPAddress	<ul style="list-style-type: none"><li>• Multicast IP address of the redundancy video flow.</li></ul>
redundancyDestUDPPort	<ul style="list-style-type: none"><li>• UDP port number of the redundancy video flow (must be 1024 or greater).</li></ul>

## NMOS Settings

There is a single PIERO-specific settings file for NMOS:

### **matrox0\_nmos.json**

There is only one option in the file:

Option	Value
enableIS05	<ul style="list-style-type: none"><li>• Controls whether PIERO responds to NMOS IS-05 connection management requests.</li><li>• Allowed values: true, false</li></ul>

★ An additional Matrox NMOS JSON settings file is described in the [NMOS Support](#) <sup>47</sup> section.

## Checking Current ST 2110 Status

This section explains how to check the current status of the ST 2110 inputs and outputs, as well as the status of ST 2059.

### To check the current status of the ST 2110 inputs and outputs and the status of ST 2059:

1. In the **Settings** panel, select the **Video** tab.
2. In the **Video** tab, select the **Log ST 2110 Status** button.

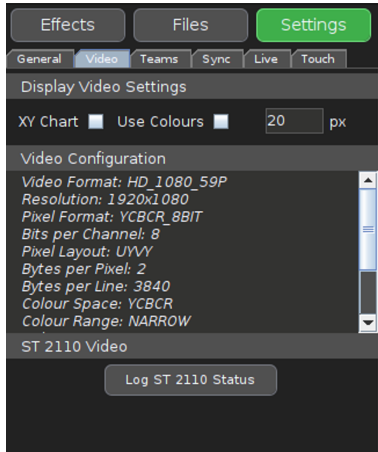

Settings Menu - Video Tab

The current ST 2110 configuration and status will be logged to the PIERO log file.

3. View the configuration and status using the **Log Viewer** as follows:
  - a. In the **Settings** panel, select the **General** tab.
  - b. In the **General** tab, select **Log Viewer**.

Information is displayed for each of the inputs and outputs, the overall ST 2059 status, and the ST 2059 status and configuration for each SFP.

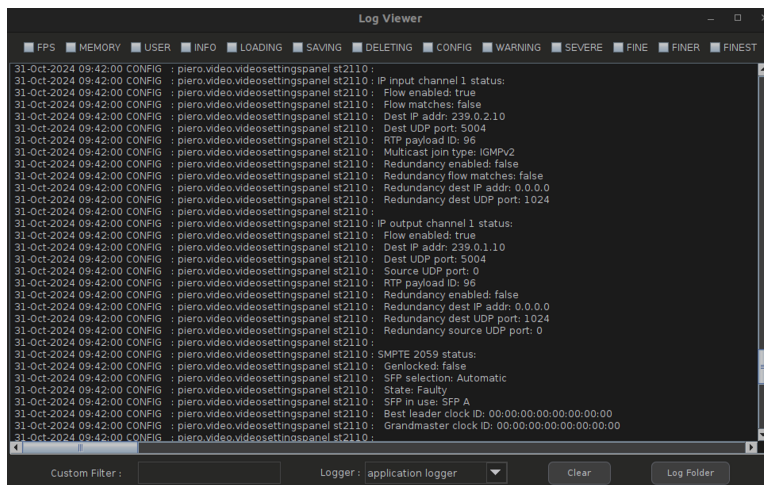

Log Viewer

# iPad Module

If the iPad is able to establish a connection with the PIERO system, the video output will be visible on the iPad and the **Remote** tab will display the iPad's IP address.

It is possible to have several iPads connected to PIERO simultaneously.

When using the iPad, place PIERO in **Touch** mode for effects to animate properly.

## Requirements

- PIERO version 10.5 or greater with the iPad module enabled
- An Apple iPad that supports the application.
- Free PIERO Remote 2 app (download from the App Store)
- Wi-Fi network that includes the PIERO PC (802.11g, 802.11n, or better); for table-mounted iPads, use an Ethernet adapter when available to improve connectivity.

## Network Setup Overview

To use the PIERO Remote iPad app you need to have a Wi-Fi network that allows the iPad to communicate with the PIERO PC. A simple example of this is shown below, in which the Wi-Fi router is attached to the PIERO PC via an Ethernet cable.

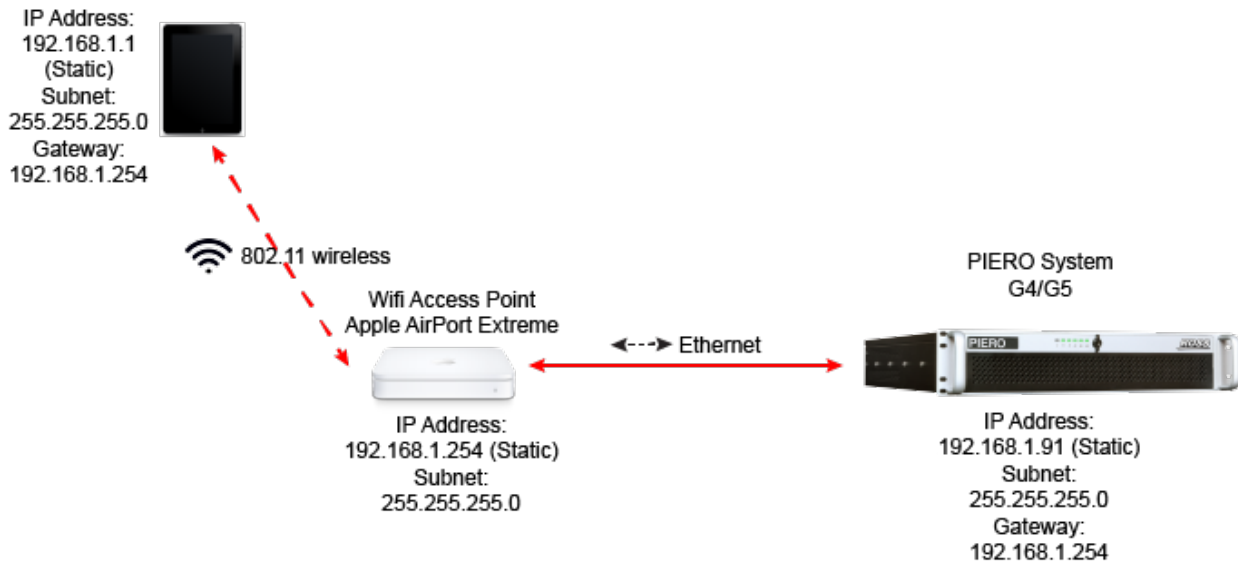

### *iPad Network Setup Example*

**PIERO System (Workstation):** We recommend that the PIERO System be assigned a static IP address. See later in the document for instructions to set the IP address.

**iPad:** You are free to use DHCP but we prefer a static IP address. Refer to Apple's documentation to set your iPad's IP address.

**Wi-Fi access point:** Ideally, the Wi-Fi access point or router should allow wireless client machines to connect directly to the PIERO PC, or at least be on the same network subnet. For good video frame rates on the iPad, the Wi-Fi connection should be 802.11g or 802.11n. In testing with an Apple Airport Extreme Wi-Fi base station, we found that the iPad 1 worked best with 802.11g, while the iPad 2 was able to provide better frame rates when using 802.11n.

## Connecting the iPad to PIERO

Once you have established a network connection, you need to connect the iPad to PIERO. You'll need PIERO's IP address, which can be found in the **Settings** panel, in the **Remote** tab.

When PIERO has established a network connection, the IP address is visible in the **Host IP Information** section. In this example, PIERO's IP is 10.98.124.107.



*PIERO's IP Address*

If the Host IP Information section is not visible you may not have the iPad module enabled on the system. Contact [techsupport@rossvideo.com](mailto:techsupport@rossvideo.com) to purchase it.

### To connect the iPad:

1. Ensure the iPad is connected to the correct Wi-Fi network.
2. Start the PIERO Remote application on the iPad.
3. Press the **Settings** button at the top of the user interface and enter the PIERO PC's IP address.

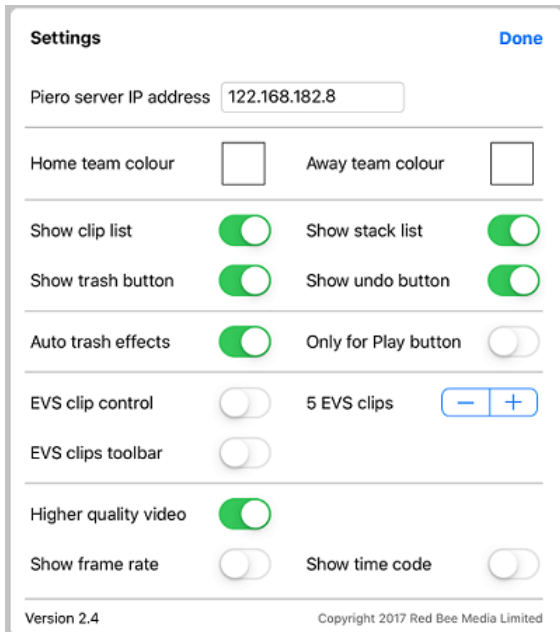

*PIERO iPad Settings*

4. Press the **Connect** button on the iPad user interface.

If the iPad is able to establish a connection with the PIERO system, the video output will be visible on the iPad and the Remote tab will display the iPad's IP address.

If the connection is not successful, check the network settings and test network connectivity.

# OPTA Module

## To start the OPTA Application:

1. Select the **OPTA** button in the PIERO launcher.
2. In **Settings > Opta Settings**, enter the login details.

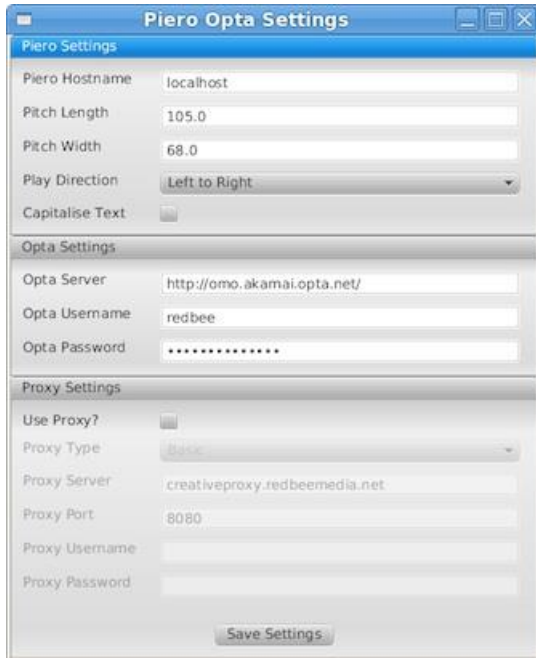

### *OPTA Settings*

If you require assistance with the login details, contact OPTA or [techsupport@rossvideo.com](mailto:techsupport@rossvideo.com).

3. Select the **Use Proxy?** checkbox and fill in the appropriate fields if you want to use a proxy to connect to the Opta server.
4. Once the settings are complete, select **Save Settings**.
5. Then select a league and select a different **Time Range** (LAST WEEK, LAST SEASON, TODAY...) to attempt a new connection and refresh the data.

This can take up to 45 seconds.

## OPTA Connection Details

The OPTA Application uses the internet to connect to OPTA servers. It attempts a connection using the http protocol over TCP/IP on port 80 (and port 53 for DNS).

The URL used is <http://omo.akamai.opta.net/>

The URL will get longer as the application adds extra parameters for requests.

Use Firefox (**Applications > Internet > Firefox**) to test if the OPTA server is responding. Manually paste the URL <http://omo.akamai.opta.net/> into the address bar of the Firefox browser.

If the Opta server is reached it will return this error message:

**<response>Error: feed\_type, game\_id are required</response>**

This is because we are attempting a manual connection via Firefox without required fields and login.

# Importing 3D Models and Sound Effects

PIERO allows the importing of user graphics such as 2D images, animated 2D images and 3D models. The following sections describe how this can be achieved.

[Importing 3D Models](#) 

[Importing Sound Effects](#) 

# Importing 3D Models

You can import 3D models into PIERO from packages such as 3D Studio MAX or Maya. 3D models can be used for custom models or 3D markers.

Currently supported 3D modeling formats include:

- Alias wavefront .obj files
- Autodesk .3ds files
- Open Scene Graph .osg files.

The formats .obj and .3ds are supported in most modeling packages, although better exporters are often available commercially.

A free .osg exporter can be found at:

[http://sourceforge.net/project/showfiles.php?group\\_id=148454&package\\_id=230090&release\\_id=552706](http://sourceforge.net/project/showfiles.php?group_id=148454&package_id=230090&release_id=552706)

The models can be used for custom models or 3D Markers. The assets must be placed in the models/user or models/markers/3Dmarkers directories.

## Requirements for 3D Models:

- The model format must have an .obj, .3ds or .osg extension.
- The model must be a polygon model made of single-sided polygons (front facing).
- The model should not include lighting, as PIERO provides lighting.
- The model resolution should be suitable for real-time rendering (e.g. markers = 1,000 polygons) otherwise frame-dropping will occur.
- The model should use standard materials and textures (i.e. do not use plug-ins or pixel shaders to model glass, etc.). Transparency and specularity may be an issue depending on the exporter.
- The texture files should not be too big and have dimensions of a power of two (e.g. 256 x 256). The models should reference textures as local external files.
- The 3D origin of the model is important: PIERO's position  $x = 0$ ,  $y = 0$ ,  $z = 0$  is the centre of the pitch, where  $y = 0$  is ground level. The Y axis represents the height of the model, the Z axis is the length and the X axis is the width.
- The model's units should be in metres. Football pitches are usually 110 x 70 meters.
- Avoid incorporating any geometry history into a 3D model.

### To import 3D models:

1. Place the 3D model in the **models/user** or **models/markers/3Dmarkers** directory.
2. Place any textures required for the models in the same directory as the 3D model.
3. Add a **3D Model** or **Markers** effect to your project.
4. In the effect's property sheet, from the **3D Model** or **Markers** property drop-down list, select the 3D model.

## Importing Sound Effects

Supported audio formats: WAV or AIFF, PCM, 32 bit, 48000 samples/second, Stereo or Mono

16 bit files will be scaled up to 32 bits/sample for output.

Files that have a sample rate of less than 48000 samples/second will be accepted, but will play out faster, with a higher pitch. PIERO will determine whether or not a file is in the right format and only allow selection of those that are correct.

# Linux Security Updater

PIERO Broadcast and PIERO Live customers can easily obtain and install security updates on their PIERO hardware running a Linux operating system. The updates are obtained from a PIERO Security Repository available via the Internet.

Your system will need to be configured using the PIERO Security Updater.

Follow the instructions in these sections to check if your system has been configured and to update your security packages:

[Checking the installation of Security Updater](#) 

[Checking the Installation of Security Updater \(Earlier Linux Version\)](#) 

[Installing the PIERO Security Updater](#) 

[Updating Security Packages](#) 

## Checking the Installation of Security Updater

If you are running the latest version of Linux use the following instructions to check the installation.

### To check the installation of Security Updater:

1. Log in as Piero.
2. From the **Applications** menu, select **System Tools > Software**.

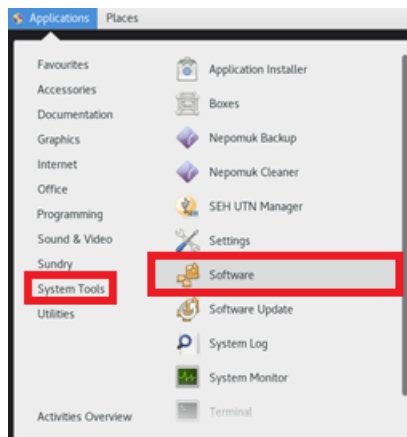

*Security Updater - Select Software*

If there is no **Software** option in the **Applications > System Tools** menu, you are using an earlier Linux version. Follow the instructions in the section [Checking the Installation of Security Updater \(Earlier Linux Version\)](#)<sup>65</sup>.

3. From the **Software** tab, select **Software Sources**.
4. The **Software Update Preference** dialog opens. The following options should be listed and checked:
  - PIERO Additional Security Repository
  - PIERO Extras Repository
  - PIERO Security Repository

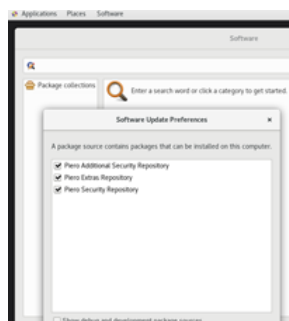

*Security Updater - Security Update Preferences*

5. If these options are not listed, see [Installing the PIERO Security Updater](#)<sup>65</sup>.

## Checking the Installation of Security Updater (Earlier Linux Version)

If you are running an earlier version of Linux use the following instructions to check the installation.

### To check the installation of Security Updater (earlier Linux version):

1. From the **Applications** menu, select **System Tools > Applications Installer**.
2. From the **Applications Installer** tab, select **Software Sources**.

The **Software Sources** dialog opens. The following options should be listed and indicate that they are installed:

- PIERO Additional Security Repository
- PIERO Extras Repository
- PIERO Security Repository

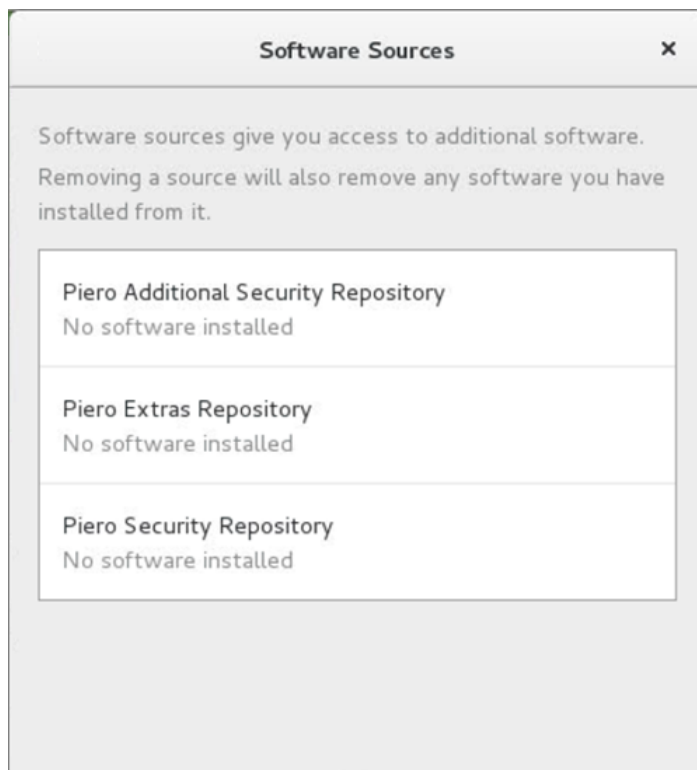

*Security Updater - Select Software Sources*

3. If these options are not listed, see [Installing the PIERO Security Updater](#)<sup>65</sup>.

# Installing the PIERO Security Updater

## Installing the PIERO Security Updater

If the PIERO Security Updater is not already installed on your system, follow the instructions below to install it.

### To install PIERO Security Updater:

1. Log in as "piero" and copy the **PieroSecurityUpdater.tar.gz** file to the desktop.  
If you do not have the **PieroSecurityUpdater.tar.gz** file, contact [techsupport@rossvideo.com](mailto:techsupport@rossvideo.com).
2. Double-click the **PieroSecurityUpdater.tar.gz** file and select **Extract**.
3. Select the **Show the files** button
4. Navigate to the **PieroSecurityUpdater** folder.
5. Double-click the **PieroSecurityUpdater** application.  
The application will appear below the window.
6. If your PIERO system has access to the Internet without using an https proxy, select **Install security updater**.

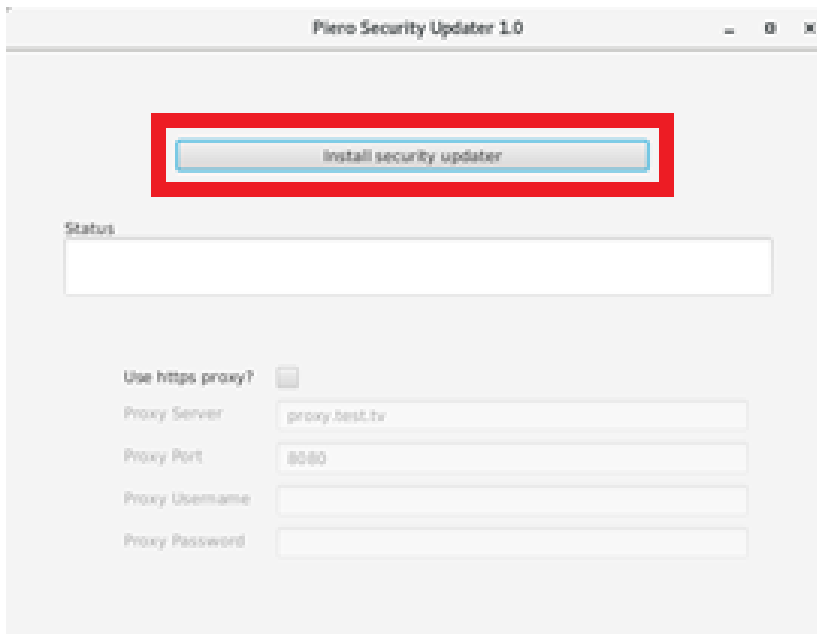

*Install Security Updater without Proxy*

**OR**

7. If your Internet access uses an https proxy:
  - a. Select the **Use https proxy?** checkbox.
  - b. Enter the proxy server and proxy port information.
  - c. If your https proxy also requires a username and password, complete those fields as well.
  - d. Then select **Save proxy and install security updater.**

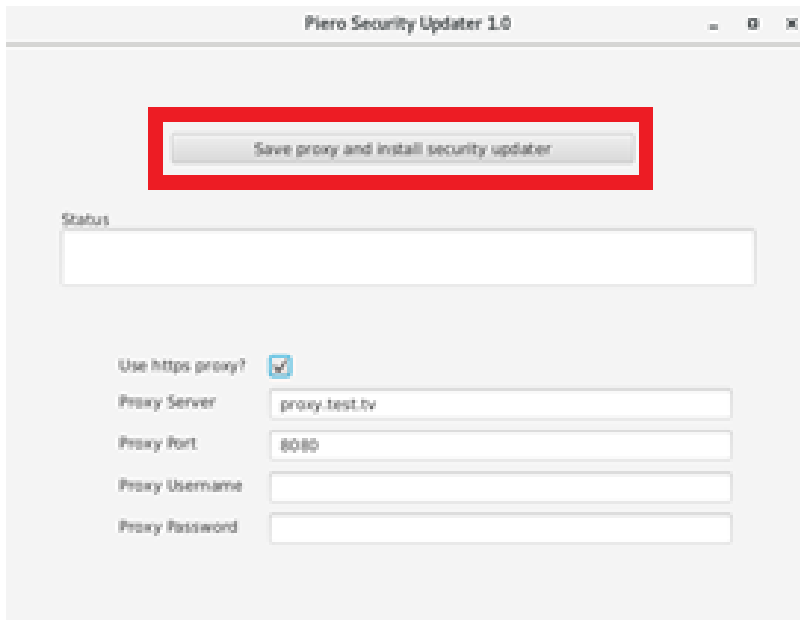

*Install Security Updater with Proxy*

★ **Tip:** If your username and/or password change, run the updater again and enter the new details.

# Updating Security Packages

This section describes how you can update and install the latest security updates.

## To update your security package:

1. Log in as "piero".
2. From the **Applications** tab, select **System Tools > Software > Check for Updates**.

**OR**

3. If you are using an earlier Linux version, from the **Applications** tab, select **Software Update**.

The **Software Update** window opens listing the available updates.

4. Select the updates you want to install and then select **Install Update**.

If your Internet is not working or there is a problem connecting to the **Security Repository**, you may see the following error message.

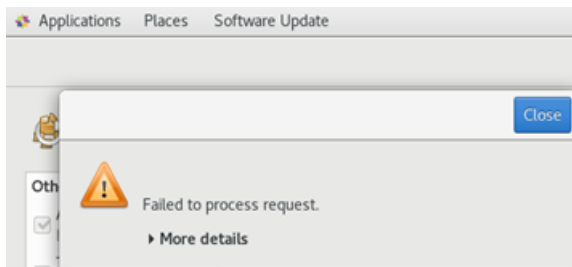

*Security Update Error Message*

5. If this happens, select **Close** and check your Internet connection.

Also, if you are using an https proxy, check to see if any of those details have changed, for example, the proxy password.

You can re-enter any of the proxy details by running the PIERO **Security Updater** application again. See [Installing the PIERO Security Updater](#).

6. When prompted with "**Do you trust the source of the packages?**", select **Trust**.
7. When prompted for authentication, enter the root password.

If you need help with the root password, contact [techsupport@rossvideo.com](mailto:techsupport@rossvideo.com).

The update will take about 20 seconds and display a message indicating that "**All packages are up to date**".

8. Select **OK** to finish.

# MIRA Replay System Integration

The integration between PIERO Broadcast and Mira Replay Systems frees the PIERO operator and Mira operator to work independently, improving the workflow between Sports Analysis Graphics and Replay. The PIERO operator can directly access clips in Mira Replay Events from the PIERO Broadcast user interface, apply graphics to a clip and then record it back to the Mira as a clip to be added to a melt or for payout.

## To connect PIERO and Mira:

- Connect SDI Output 5 of PIERO Broadcast to the Mira channel that is the last channel of the ISO Record.
- Connect SDI Input 1 of PIERO Broadcast to the Mira channel that the PIERO Broadcast operator will be controlling.

## To configure the Mira Replay system:

1. Launch the Mira Config application.
2. If prompted to allow the program to make changes on the computer, select **Yes**.

The **Engineering Setup** window opens.

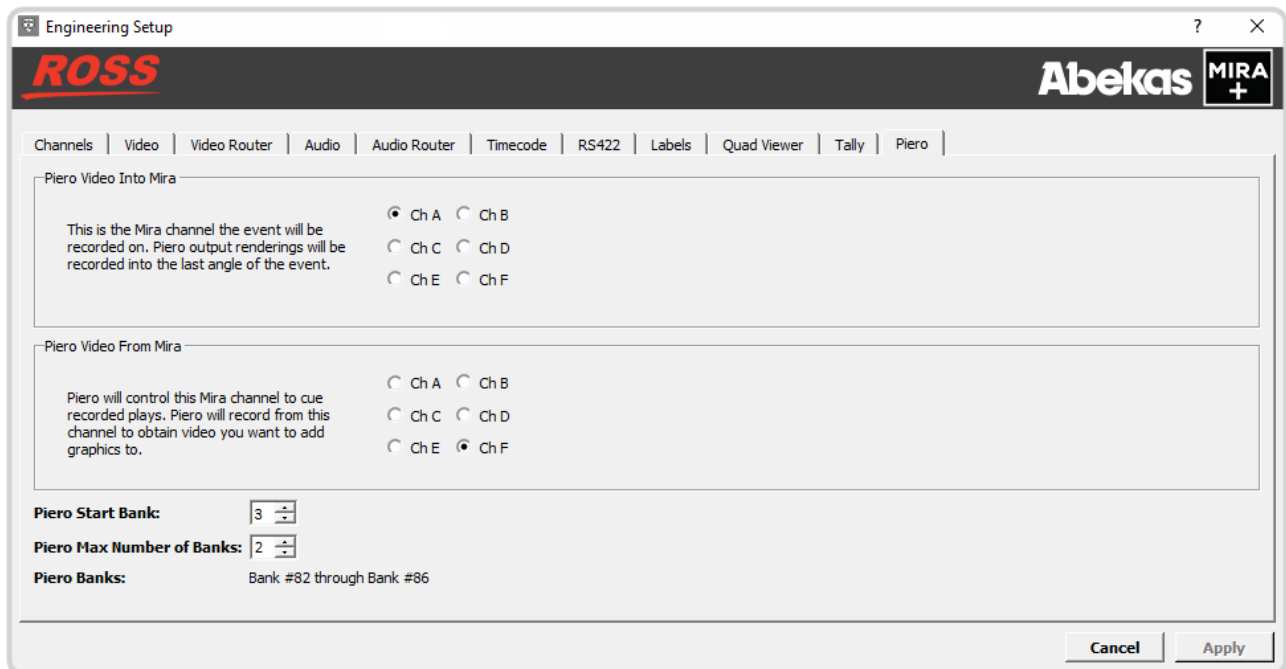

### *Mira Replay System Configuration*

3. Select the **PIERO** tab.
4. In the **PIERO Video Into Mira** section, select **Ch A**.

This will tell the replay system that the last channel of ISO record will be the PIERO Broadcast record channel.

5. In the **PIERO Video From Mira** section, select **Ch F**.

This is the channel that the PIERO operator will use for editing and recording.

6. In the **PIERO Start Bank** field, enter or use the arrows to select the number of starting banks to which PIERO Broadcast will record clips.
7. In the **PIERO Max Number of Banks** field, enter or use the arrows to select the maximum number of banks to be used for PIERO Broadcast clips.

**Note:**

Once recorded from PIERO Broadcast, clips will appear in the designated PIERO banks.

**To configure PIERO Broadcast for Mira control:**

1. Launch PIERO.
2. In the **Settings** panel, in the **General** tab, set the **Default Response Time** to the number of fields you have calculated the response time to be.

See [Calculating the Correct Response Time](#)<sup>(103)</sup> for more information.

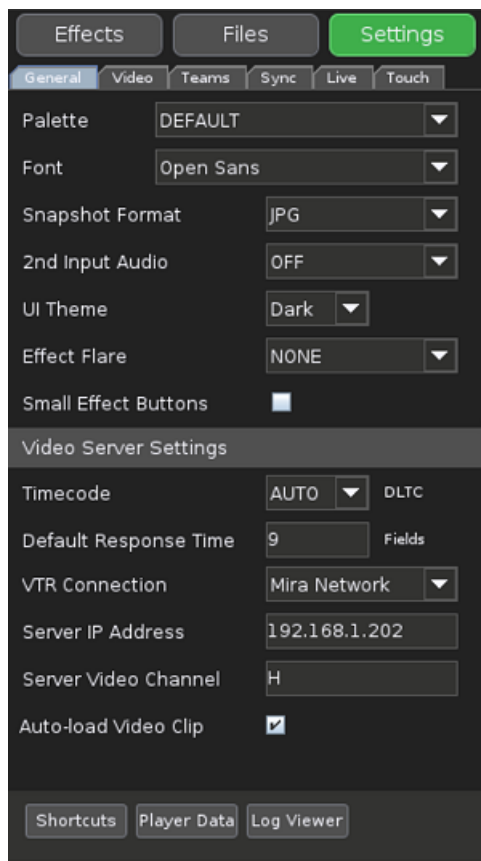

*PIERO Settings - Mira Network*

3. From the **VTR Connection** drop-down, select **Mira Network**.
4. In the **Server IPv4 Address** field, enter the IP address of the Mira replay system.
5. In the **Server Video Channel** field, enter the Mira channel to be controlled by the PIERO operator.

## Example Configuration Setup

6-Channel Mira Example	8-Channel Mira Example
<p>SDI 5 OUT of PIERO, into Mira Channel E.</p> <p>Mira Channel F OUT, into PIERO SDI 1.</p> <ul style="list-style-type: none"><li>Mira replay channel is occupied by the PIERO operator, designated in <b>Mira Engineering Setup &gt; PIERO</b> tab.</li></ul> <p>Channel F will be PGM OUT of Mira:</p> <ul style="list-style-type: none"><li>Channel assigned to the <b>Control Panel</b> in <b>Mira Engineering Setup &gt; PIERO</b> tab.</li><li>ISO5 record set in <b>Mira Engineering Setup &gt; Video</b> tab.</li></ul>	<p>SDI 5 OUT of PIERO, into Mira Channel G.</p> <p>Mira Channel H OUT, into PIERO SDI 1:</p> <ul style="list-style-type: none"><li>Mira replay channel occupied by the PIERO operator, designated in <b>Mira Engineering Setup &gt; PIERO</b> tab.</li></ul> <p>Channel H will be PGM OUT of Mira:</p> <ul style="list-style-type: none"><li>Channel assigned to the <b>Control Panel</b> in <b>Mira Engineering Setup &gt; PIERO</b> tab.</li><li>ISO7 record set in <b>Mira Engineering Setup &gt; Video</b> tab.</li></ul>

# Operation

Mira integration allows you to load a clip from the Mira replay system, edit and record the clip and have the edited clip available in Mira.

## To load a clip to the PIERO Broadcast timeline:

1. Launch PIERO.
2. From the PIERO Broadcast UI, select the clip bank.

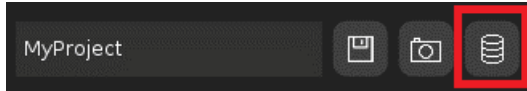

*Clip Bank Icon*

This will open the **Mira Clip Register** which displays the clips on the connected Mira replay system.

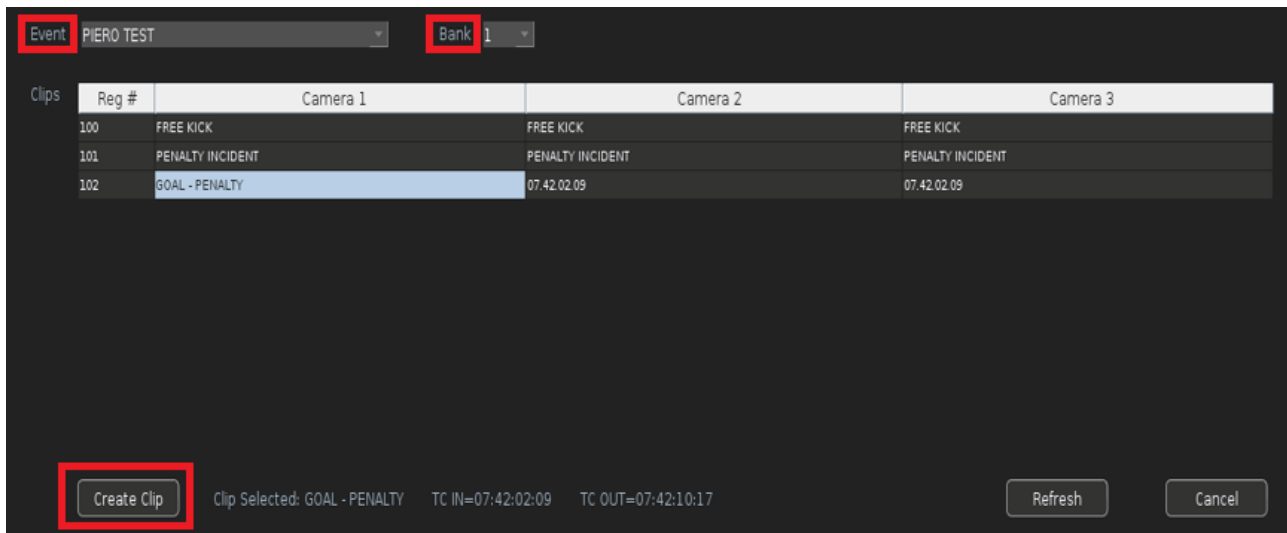

*Select an Event and Bank*

3. From the **Event** drop-down, select the replay event you want add to the PIERO Broadcast timeline.
4. In the **Bank** field, enter or use the arrows to select the number of the bank where the clip is located.
5. Select which camera view you want.
6. Then press **Create Clip** to load the clip to the timeline for editing.

## To edit and record a clip:

1. On the PIERO Broadcast timeline, click on the row corresponding to the clip you want to edit and record.

The **Mira Clip** property sheet opens.

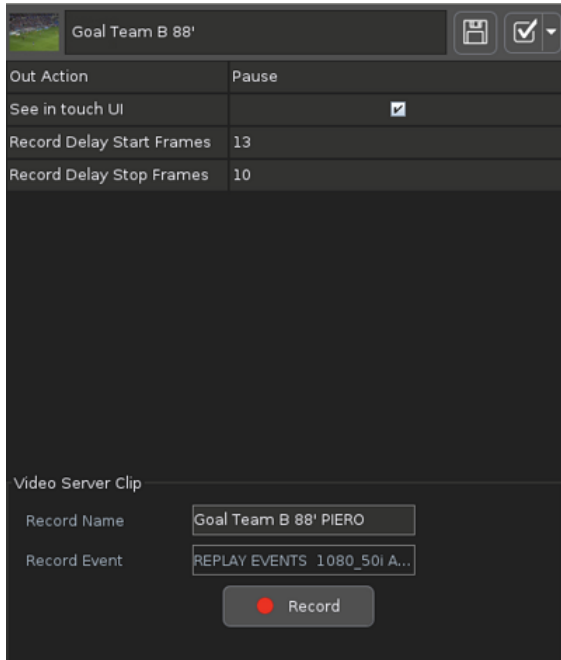

Out Action	Pause
See in touch UI	<input checked="" type="checkbox"/>
Record Delay Start Frames	13
Record Delay Stop Frames	10

Video Server Clip

Record Name: Goal Team B 88' PIERO

Record Event: REPLAY EVENTS 1080\_50i A...

Record

*Mira Clip Property Sheet*

2. From the **Record Delay Start Frames** drop-down, select the number of frames to delay before starting the recording of a clip.
3. From the **Record Delay Stop Frames** drop-down, select the number of frames to delay before stopping the recording of a clip.
4. In the **Record Name** field, enter a name for the clip.

This name will be seen in the Mira bank.

5. Then press **Record**.

Once recorded, the Mira operator can access the clip from the defined PIERO bank in Mira.

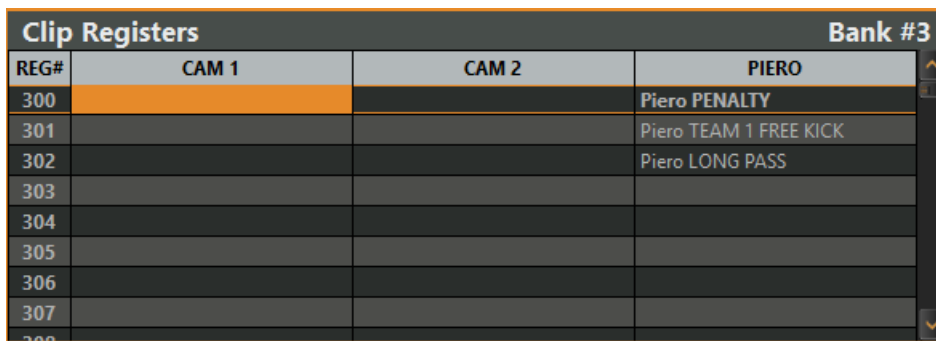

REG#	CAM 1	CAM 2	PIERO
300			Piero PENALTY
301			Piero TEAM 1 FREE KICK
302			Piero LONG PASS
303			
304			
305			
306			
307			
308			

*PIERO Bank in Mira*

# EVS Configuration

PIERO requires 1 output channel on the EVS XT(2). This does not have to be the main program channel. A useful mode in the Application List is TRIPLE. This enables the user to have 3 input channels and 3 output channels. With this mode a second operator can still build playlists and play clips to air using channels 1 and 2, while the PIERO operator uses the 3rd channel.

PIERO must be set up in parallel with an EVS remote.

★ **Note:** EVS is not a Ross Video product; consult EVS support for assistance with any EVS-specific issues.

## To configure the EVS channel:

1. Use the supplied RS232 to RS422 converter/amplifier cable.
2. Attach the male end of this cable to an auxiliary port on the rear of the EVS.  
There are 6 ports in total but port 1 has to be an EVS controller.
3. Configure the port to use **Sony BVW75** or **DD35** protocol.  
Typically, operators use the 5th port to avoid having to re-configure the EVS too often.  
The rest of this section will refer to Port 5.

# EVS Multicam (10.xx.xx and earlier)

## Protocol and Parallel Mode

This section provides instructions for configuring the protocol and enabling parallel control. Instead of having PIERO exclusively controlling the EVS channel, it is now possible to set the output channel to be controlled by both PIERO and an EVS Controller.

### To configure the protocol:

1. Press **SHIFT** and then press **MENU** to access the base menu.
2. Press **SHIFT** and then press **D** (the fourth button just above the T-Bar) for **Setup**.
3. Press **F7** for **RS422 Control**.

This accesses the **RS422** menu where the EVS can be made aware that PIERO is now connected to an auxiliary port. In this case **Port 5** is being used.

4. Use the **F9/F10** keys to navigate through the menu pages to page **7.1**.

On the left-hand side the 6 ports are shown, corresponding to the ports on the rear.

The first port will always be an **EVS REMOTE**.

**Port 5** must be assigned to **SONY BVW75**.

5. Press **F5** and use the jog wheel on the remote until the **SONY BVW75** protocol is displayed.



*Configuring Port 5*

If you can't find the **SONY** protocol contact EVS directly to check that the correct option code (**code 118**) has been activated on the EVS.

6. Press **F10** on the remote to access page **7.2.**, the **Special Control Setting** page.
7. Press **F3** and rotate the jog wheel until the area displays **EVS Remote**, if it does not already.

8. Press **F7** and rotate the jog wheel until the area displays **Sony BVW75** on **Port 5** (the PIERO port).



#### *Protocol Setup*

The channel is now set to be controlled by both PIERO and the EVS.

Now you need to enable them to work at the same time (parallel control).

#### **To enable parallel control:**

1. Press **F10** twice on the remote to access page **7.4**.
2. Press **F3** to select **Program 3 (PGM3)**.
3. Rotate the jog wheel until the display shows **Parallel**.



#### *Enabling Parallel Control*

4. Press **Menu** twice to confirm these settings and exit the menu.

Timecodes should now be visible on the PIERO monitor and both PIERO and EVS Remote can control the EVS output.

# EVS Multicam (11.xx.xx or later)

## Protocol and Parallel Mode

In version 11.xx.xx of the EVS Multicam the menus have been reorganized. The aim is the same; the auxiliary port still uses Sony/DD35 protocol and the output must be controlled in parallel.

### To configure the protocol:

1. Press **SHIFT** and then press **MENU** to access the base menu.
2. Press **F10** to access the **Technical Setup** section.
3. Press **F9/F10** to navigate through the menu pages to page **2.2**.
4. Press **F5** and rotate the jog wheel to select **XtenDD35** on **Port 5** (the PIERO port).



*Protocol Setup*

5. Press **F10** to access page **2.3**.
6. Press **F5** to add a secondary controller on a program/output.

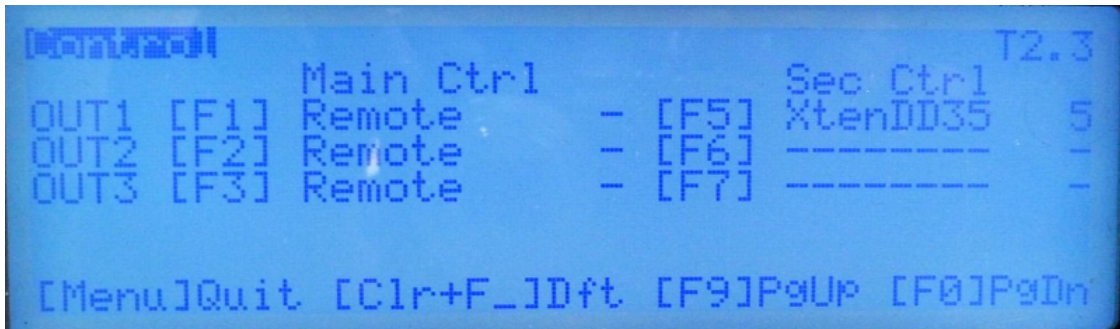

*Add Secondary Controller*

**To enable parallel control:**

1. Press **F10** twice to access page **2.5**.
2. Press **F1** and rotate the jog wheel until the display shows **Parallel**.

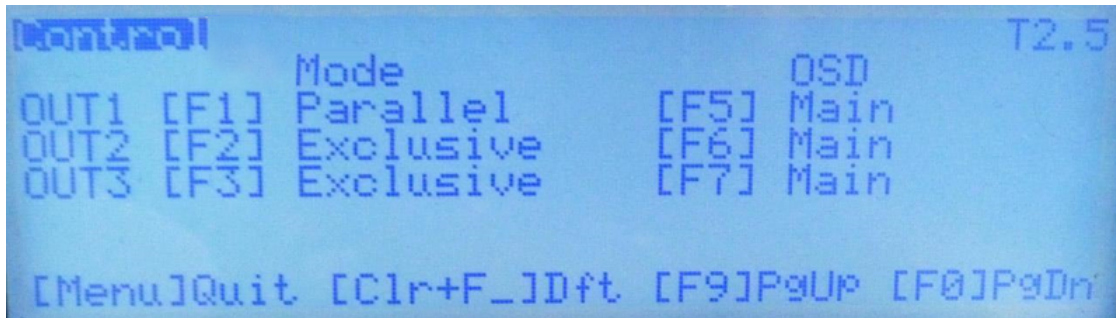

*Enable Parallel Control*

3. Press **Menu** twice to confirm these settings and exit the menu.

**To configure the second controller on the VGA monitor:**

1. Press **SHIFT + F2** and browse to **2.CHANNELS**.
2. Press **F3** to show the advanced options.
3. Set the second controller to be **XtenDD35** on **Port 5** with parallel mode.

## Enabling VITC (XT2 Only)

VITC (or DVITC in HD) are recommended as sources of timecode within PIERO. LTC timecodes are sent on the 422 cable and prone to delay/interferences. (D)VITC are embedded in the frame therefore more accurate. VITC processing is available on EVS XT2 but is not enabled by default.

To enable VITC you will need the EVS keyboard and a VGA output.

### To check which Multicam version is running:

- Press **SHIFT + MENU** on the remote or **SHIFT + F5** on the keyboard.

### To enable VITC on Multicam 10.xx.xx or earlier:

1. Press **SHIFT + F2** on the **XT2** keyboard to access the setup configuration screen.
2. Press **Pg DN** to move to **page 2 (Channels)** of setup configuration.
3. Press **TAB** to access the **PLAY1** column of the **D-VITC** row.
4. Press the left arrow key to change this field from **No** to **LTC** to use the current timecode.
5. Press **TAB** three times to access the **CleanVBI** row of the **PLAY1** column.
6. Press the left arrow key to change this field from **No** to **Always**.

This is useful to prevent the occasional corrupted **VITC** field.

### To enable VITC on Multicam 11.00.xx:

1. Press **SHIFT + F2** to access the setup configuration screen.
2. Then press **F3** to turn on **Advanced Mode**.

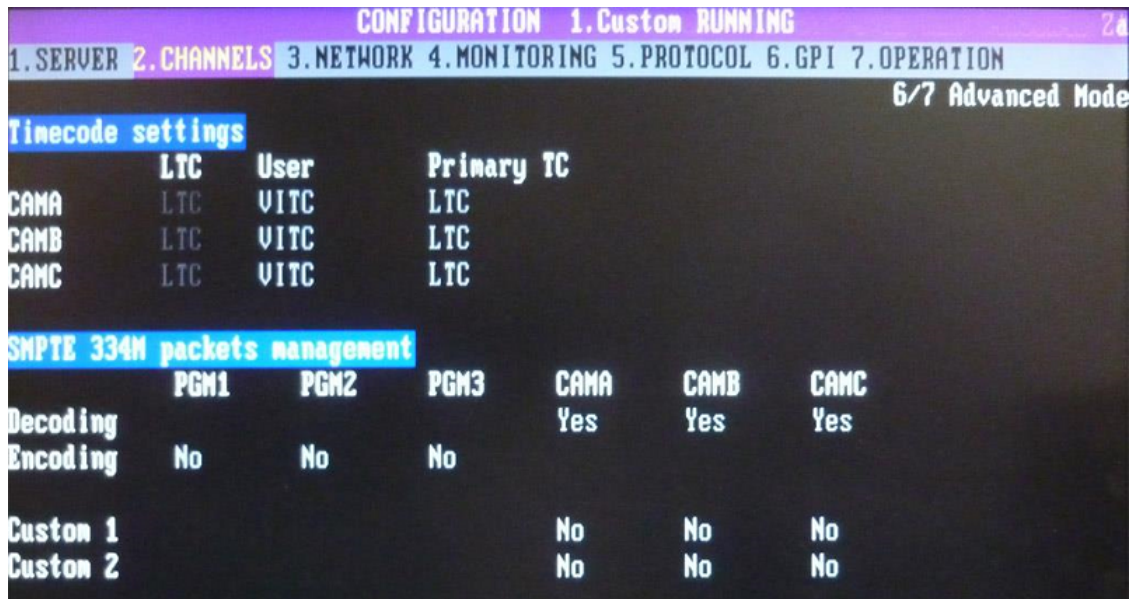

Advanced Mode - 6/7

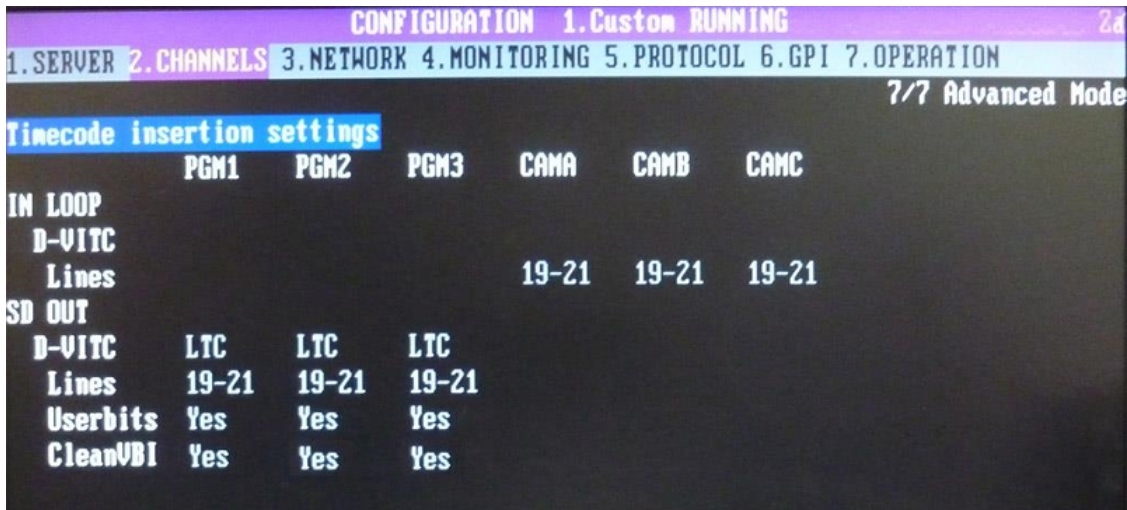

Advanced Mode - 7/7

To enable VITC on Multicam 11.02.76 or above:

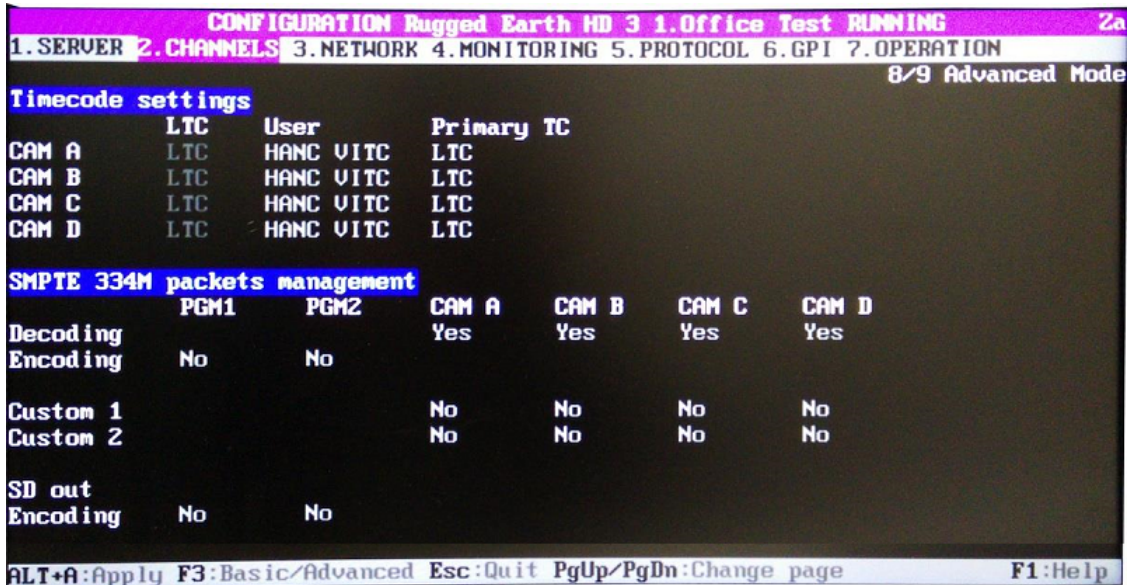

Advanced Mode - 8/9

CONFIGURATION Rugged Earth HD 3 1.Office Test RUNNING 23						
1.SERUER 2.CHANNELS 3.NETWORK 4.MONITORING 5.PROTOCOL 6.GPI 7.OPERATION						
9/9 Advanced Mode						
Timecode insertion settings						
	PGM1	PGM2	CAM A	CAM B	CAM C	CAM D
IN loop						
D-VITC						
Lines			19-21	19-21	19-21	19-21
HD out						
HancLTC	LTC	No				
Userbits	Yes	Yes				
HancVITC	LTC	No				
Userbits	Yes	Yes				
SD out						
D-VITC	No	No				
Lines	19-21	19-21				
CleanVBI	No	No				
ALT+A:Apply F3:Basic/Advanced Esc:Quit PgUp/PgDn:Change page F1:Help						

Advanced Mode - 9/9

# Evertz DreamCatcher Configuration

This section provides instructions for configuring the Ross Video PIERO system to integrate with an Evertz DreamCatcher Replay or Clip Server for channel control over the AMP protocol. The AMP protocol enables PIERO to pause, play, rewind, cue, and shuttle a DreamCatcher output.

Before beginning the configuration process, ensure familiarity with the following components:

- The location of the DreamCatcher server, along with its keyboard and monitor.
- The network switches connected to the first two ports of the server.
- An engineering computer connected to the same network as the server.
- The location of PIERO, including its keyboard, monitor, video connections, and network cabling.

It is recommended to coordinate with the local network administrator to obtain details regarding the network, including IP addresses for PIERO and the DreamCatcher server, subnet masks, and gateway addresses. If this information is not available, the following instructions provide steps to retrieve it.

★ If the "Infrastructure Network" IP address for the DreamCatcher is unknown, obtain it from the DreamCatcher system before proceeding.

The configuration process follows a structured workflow. First, the DreamCatcher IP address must be retrieved to determine network settings and ensure proper connectivity. Once this information is obtained, an IP address is assigned to PIERO so that it can communicate within the same network as DreamCatcher. Finally, the AMP protocol is configured to enable command and control functionality between PIERO and DreamCatcher. Following this sequence ensures a smooth and efficient setup process, minimizing network conflicts and connectivity issues.

The following procedures are covered in this section:

[To retrieve the DreamCatcher IP Address](#) 

[To assign an IP address to PIERO](#) 

[To Configure the AMP Protocol for PIERO](#) 

## To retrieve the DreamCatcher IP Address:

1. Locate the keyboard and monitor connected directly to the DreamCatcher server.
2. Open a terminal window by pressing **Shift + Ctrl + Fn + F12** on the keyboard.

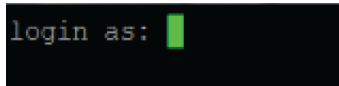

Terminal Window

3. Log in with the following credentials:

- **Username:** admin
- **Password:** admin

★ If login fails, contact the local network administrator for the correct credentials.

The **Main Menu** opens.

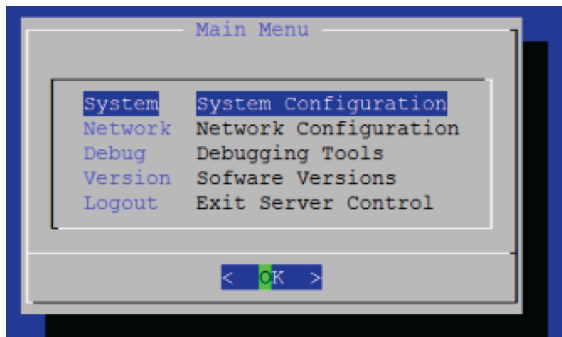

Main Menu

4. In the **Main Menu**, arrow down to select **Network** and press **Enter**.

The **Network Details** page opens, displaying the available Ethernet ports.

There are four Ethernet ports on a DreamCatcher. **(eth0)** is designated as "DreamCatcher Communication Network". Also, **(eth1)** is designated as "Infrastructure Network". PIERO should be attached to the same network as the "Infrastructure Network" **(eth1)**.

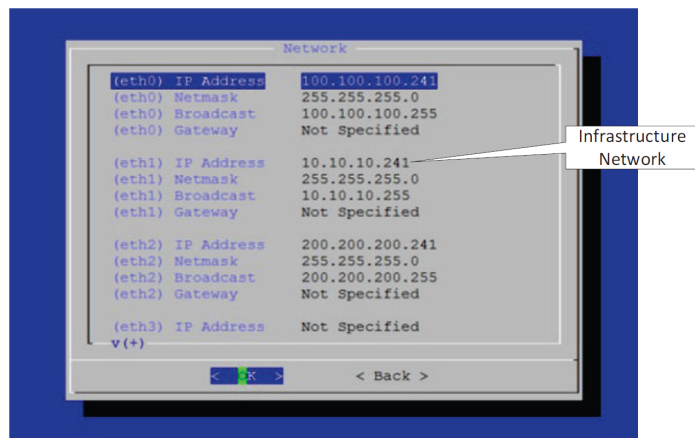

Network Menu - Infrastructure Network

- **eth0:** DreamCatcher Communication Network.
- **eth1:** Infrastructure Network (PIERO should be connected to this network).

5. Close the menu if no changes are required.
6. If changes are made, select **Save** and **Restart** (or **Reboot**) to apply them.
7. Next, [assign an IP address to PIERO](#) .

#### To assign an IP address to PIERO:

1. Determine an appropriate address for the PIERO.
2. If the PIERO IP address is unknown, check with the local network administrator for an unallocated IP address.

Alternatively, use an engineering computer on the network to identify an available IP as follows:

- a. Open a command window and execute a ping command to check for 10.10.10.241.
- b. If a response is returned, it is reasonable to assume the engineering computer is on the same network.
- c. Next, ping 10.10.10.242 and if this address is free, make note of it.

★ Example: If 10.10.10.241 is assigned, test 10.10.10.242 for availability.

3. Inform the local network administrator of the selected IP address and confirm which network switch the engineering computer is connected to.
4. Next, [configure the AMP Protocol for PIERO](#) .

#### To configure the AMP Protocol for PIERO:

1. Open an internet browser on the engineering computer (Chrome or Firefox recommended) and set the AMP Protocol as follows:
  - a. In the URL bar, enter the IP address of the DreamCatcher server followed by **/viewweb**, then press **Enter**.

Example: 10.10.10.241/viewweb



*Browser URL bar with example IP address*

The DreamCatcher **VUEWEB** login screen opens.

- b. In the DreamCatcher VUEWEB login screen, enter the following:
  - Username:** admin
  - Password:** admin
- c. Press **Enter**.
- d. In the sidebar, select **dcsamp**.
- e. Set **Enable DCSAMP** to **ON**.
- f. Select **No duplicate clip names**.
- g. From the **Protocol** drop-down, select **AMP Sockets TCP (Port 3811)**.
- h. Record the **AMP Sockets TCP Channel Name** for later use in the AMP Protocol Configuration.
- i. Select **Save** and **Restart** to apply the changes.

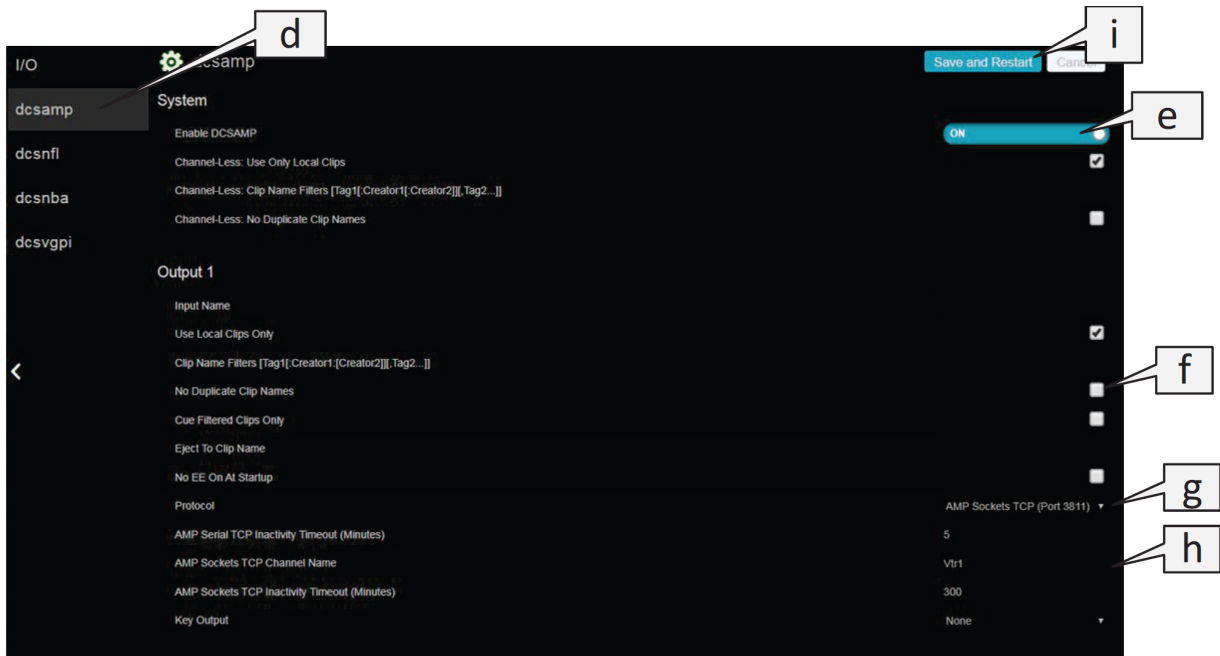

### DCSAMP Settings

The PIERO system is now configured to communicate with the DreamCatcher server using the AMP protocol. Ensure all network connections are properly set up and validated before proceeding with further system integration.

# Video Device Compatibility

Device		Version	Works	Notes
<b>Avid</b>	Airspeed		No	Supports Sony 422 BVW protocol but some vital commands are not supported (VTR status, timecode and jump to timecode requests fail).
<b>EVS</b>	XT1	MultiCam pre V8	No	<ul style="list-style-type: none"> <li>LTC reliable</li> <li>VITC not reliable</li> <li>Parallel remote unavailable</li> </ul>
		Multicam V8	Yes	<ul style="list-style-type: none"> <li>LTC reliable</li> <li>VITC not available</li> <li>Parallel remote available</li> </ul>
	XT2	Multicam pre V9	No	<ul style="list-style-type: none"> <li>Timecodes unreliable</li> </ul>
		Multicam V9	Yes	<ul style="list-style-type: none"> <li>Supports DVITC/DLTC/VITC</li> <li>LTC unreliable</li> </ul>
		Multicam V10	Yes	(Preferred Option) <ul style="list-style-type: none"> <li>Reliable LTC</li> </ul>
	XT3	Multicam V11	Yes	<ul style="list-style-type: none"> <li>Better response time</li> </ul>
	XT4	Mu		<ul style="list-style-type: none"> <li>Meets required specifications</li> <li>Untested</li> </ul>
	IP Director	2013 and above	Yes	<ul style="list-style-type: none"> <li>Requires an LSM XT2/3 - Saves a remote but slower workflow</li> </ul>
<b>Grass Valley</b>	K2 Client		Yes	<ul style="list-style-type: none"> <li>When a "go to timecode" or "jog" command is sent, the server stops responding for a few moments.</li> <li>Slow workflow</li> <li>No jog wheel</li> </ul>
	K2 Summit & K2 Dyno (replay controller)		Yes	
	Turbo iDDR/T2 iDDR		Yes	
	M2		Yes	
<b>Harris</b>	Nexio 3600 HDX		Yes	<ul style="list-style-type: none"> <li>No jog wheel or remote control unit as standard, which can make workflow slow</li> </ul>
<b>Panasonic</b>	DVCPPro50	AJ-D950	Yes	<ul style="list-style-type: none"> <li>VITC not available</li> </ul>
<b>Quantel</b>			X	<ul style="list-style-type: none"> <li>Not fully controllable via 422</li> <li>Not designed to pause on the fly</li> </ul>

Device		Version	Works	Notes
Sony	XDCam	PDWF75	Yes	
	J Series		No	• Jitters on paused frame
	Digibeta		Yes	

# PIERO File Sharing Assistant

## Overview

PIERO reads video clips from its **PieroSource** folder and writes video clips to its **PieroExport** folder. The PIERO File Sharing Assistant enables networked computers to exchange files to and from these folders. The PIERO File Sharing Assistant provides control of sharing via the Server Message Block (SMB) only. The contents of the clips folder on the PIERO system are shared out to other computers.

When connecting to the PIERO system's SMB server it will make two shares available: **PieroSource** and **PieroExport**.

## Username and Passwords

The username used for the SMB connection is **pierofs**. The password must be set before use.

If after installing version 17.4 over a previous version of the software it is no longer possible to connect to the PIERO share, please use the File Sharing Assistant to reset the password.

## Restrictions

- Video frame rate is not guaranteed during file transfers

The correct video output frame rate is not guaranteed over SDI during file transfers to/from the PIERO system.

All file transfers should therefore be fully completed before PIERO needs to be used **ON AIR**.

- Overwriting SMB uploaded files is not supported

When exporting a video file, the PIERO application cannot overwrite a file that has been uploaded from an SMB client.

For example, if a file called **myFile.mov** was uploaded to the PIERO system from an SMB client, the PIERO application cannot overwrite it by exporting a video file named **myFile.mov**.

The name of the file being exported from the PIERO application will need to be changed so that it is unique.

### To start the PIERO File Sharing Assistant:

- Double-click this icon to open the application.

The user interface shows the SMB share details. Any changes you make will be remembered even if your computer is restarted.

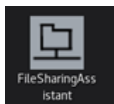

*File Sharing Assistant*

## To share files:

1. Select the **Enable SMB Server** checkbox  
Deselect the **Enable SMB Server** checkbox to stop the SMB server.
2. The **IP address** box lists all the IP addresses that are currently active on the customer's machine
3. In the **Password** field, enter a secure password.
4. In the **Workgroup** field, enter a name for the group.

The username for the share is pierofs.

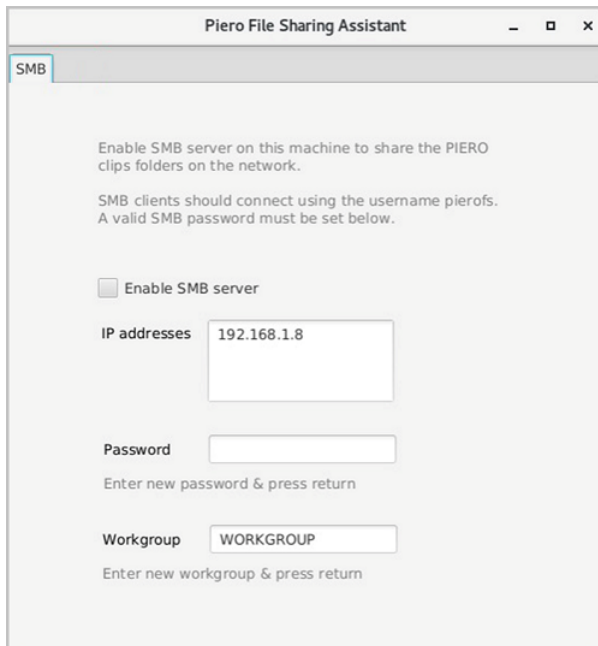

*Connecting to PIERO's System SMB Server*

## To access an SMB share from Windows 10:

1. Select the **Add a network location** icon.

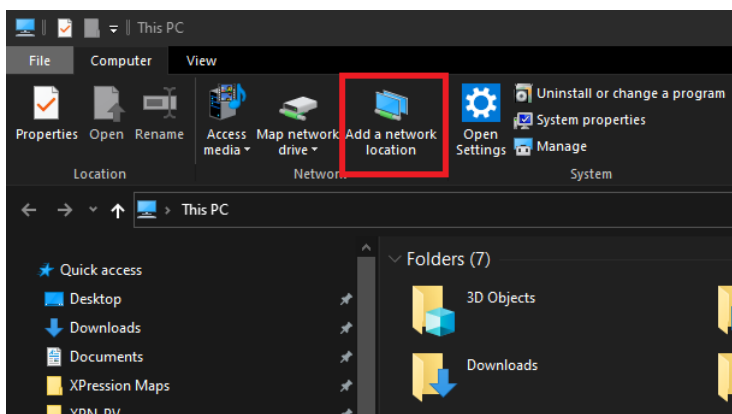

*Accessing PieroSource Share on PIERO SMB Server from a Windows PC*

2. Select a network location.

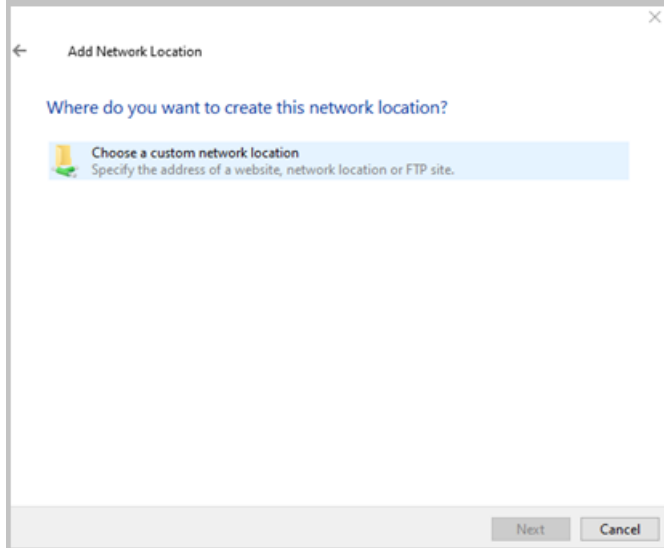

*Selecting a Network Location*

3. Specify the location of the website.

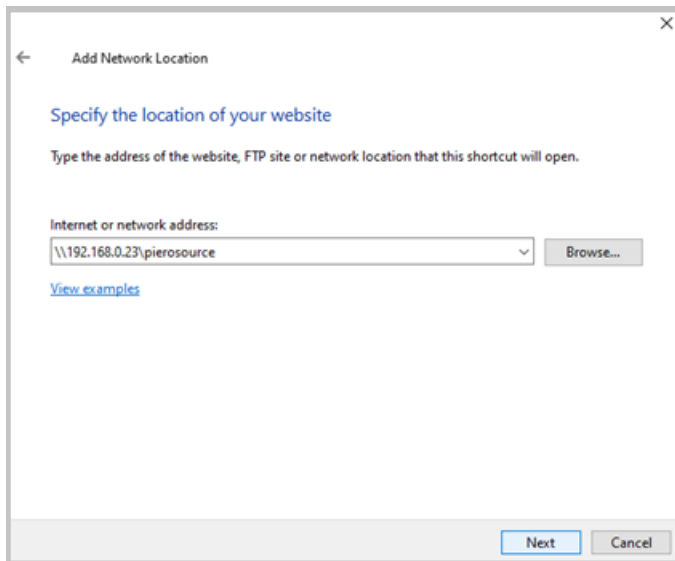

*Specifying the Location of the Website*

4. When prompted, enter the username `pieroofs`, and the **SMB** password created in the **File Sharing Assistant**.

The **PieroExport** share can be accessed in a similar way.

**To access an SMB share from a MAC:**

1. From the **Finder's Go** menu, select **Connect to server**.
2. In the server's dialog enter the PIERO system's IP address and `PieroSource`, as in the image below.

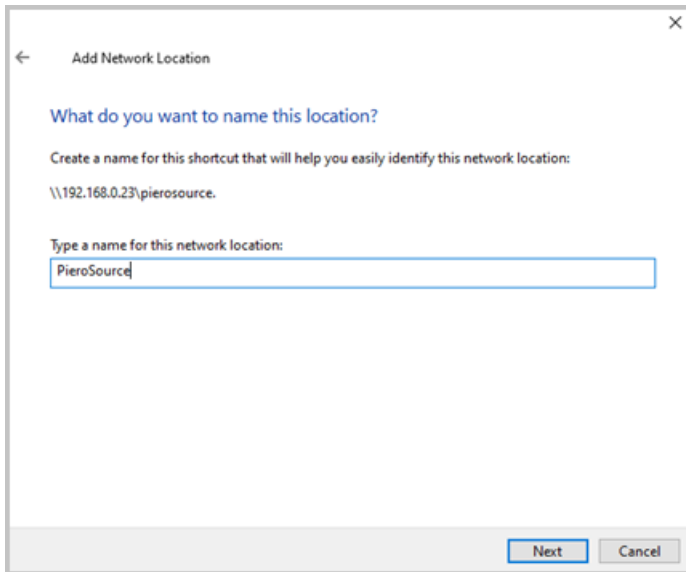

*Specify a Location Name*

This will open a folder showing files in the server's **PieroSource** directory.

3. Enter the PIERO system's IP address and `PieroSource`, as in the image below.

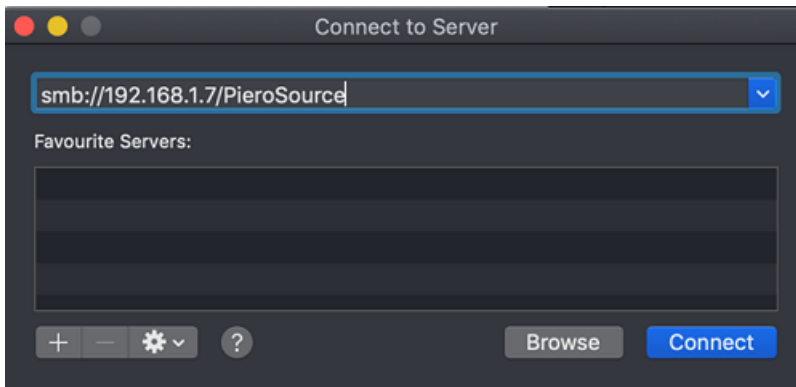

*Enter PIERO System Details*

The **PieroExport** share can be accessed in a similar way.

# Codec Compatibility

## Standard Pack

Codec	Video Formats	Audio	File Type
h264/AVC	1080p /25/30/50/59.94 1080i /25/29.97 720p /24/25/30/50/59.94 PAL 16x9 /25 PAL 4x3 /25	48kHz Uncompressed LPCM audio in an AES3 SMPTE 382M stream Uncompressed PCM audio AAC audio MPEG-1 audio	.mov .mp4 (read)
XAVC Intra 100 CBG	1080p /50/59.94	AES PCM 24 bit 48kHz	.mxf
XAVC Intra 100 RP2027	1080p /25 1080i /25/29.97 720p /25/50/59.94	AES PCM 24 bit 48kHz	.mxf
MPEG2	1080p /25/30/50/59.94 1080i /25/29.97 720p /24/25/30/50/59.94 PAL 16x9 /25 PAL 4x3 /25	48kHz Uncompressed LPCM audio in an AES3 SMPTE 382M stream Uncompressed PCM audio AAC audio MPEG-1 audio	.mov (read) .mpg
XDCAM 422	1080p /25 1080i /25/29.97 720p /50/59.94	AES PCM 24 bit 48kHz	.mxf
XDCAM EX	1080i /25/29.97 720p /25 (read only) /50/59.94	48kHz Uncompressed LPCM audio in an AES3 SMPTE 382M stream Uncompressed PCM audio AAC audio MPEG-1 audio	.mxf (read) .mov
AVC Intra 100	1080i /25/29.97 720p /25/50/59.94	48kHz Uncompressed LPCM audio in an AES3 SMPTE 382M stream Uncompressed PCM audio AAC audio MPEG-1 audio	.mov

## Premium Pack

Codec	Video Formats	Audio	File Type
DNxHD	1080p /25/30/50/59.94 1080i /25/29.97 720p /25/30/50/59.94	AES PCM 24 bit 48kHz	.mxf
DV/DVC PRO HD	1080i /25 720p /50/59.94 PAL 16x9 /25 PAL 4x3 /25	AES PCM 16 bit 48kHz	.mxf

# DashBoard Integration

DashBoard can remotely control some elements of PIERO. To do this, the **Piero.xml** file needs to be placed in **DashBoard\VisualLanguage\blocks\Devices**. Once this has been done, DashBoard needs to be restarted. PIERO will then appear as a device that can be added just like any other.

Once a PIERO system has been added, DashBoard will prompt for the IP address of the PIERO system that you will be controlling. Once the IP address has been provided, the following visual DashBoard blocks will be available to use:

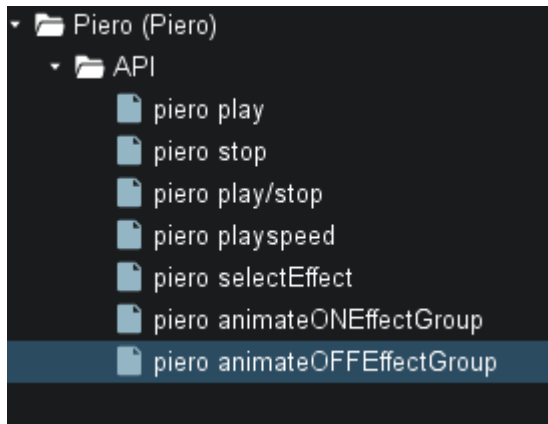

*PIERO Blocks*

## Dashboard Blocks

The available DashBoard blocks are described below:

### Play

Starts playing the current video feed in PIERO. If PIERO is already playing, this command won't do anything.

Required parameters: NONE

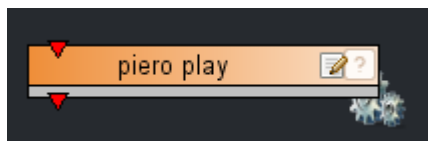

*DashBoard - PIERO Play*

### Stop

Pauses the current video feed in PIERO. If PIERO is already paused, this command won't do anything.

Required parameters: NONE

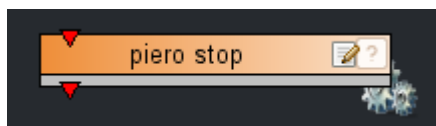

*DashBoard - PIERO Stop*

## Play/Stop

Pauses the current video feed in PIERO if PIERO is already playing. If PIERO was paused, it will resume playing.

Required parameters: NONE



*Dashboard - PIERO Play/Stop*

## PlaySpeed

Changes the speed at which PIERO plays. The **Play Speed** parameter is a decimal value that is defined as follows:

- **Play Speed < 0** the video will be played backwards.
- **Play Speed = 0** the video will be paused.
- **Play Speed > 0** the video will be played forwards.

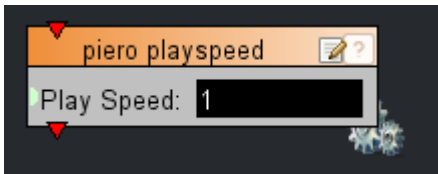

*Dashboard - PIERO Play Speed*

## Select Effect

Selects a specific effect.

It receives a string as a parameter with the name of the effect to select. When selecting a calibration, it will also select the associated key and video input in the same camera group. In PIERO **Live** this can also be used to select an effect group.

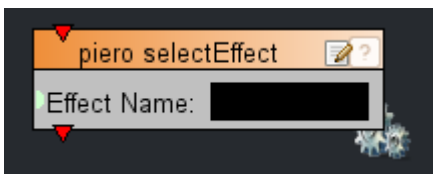

*Dashboard - PIERO Select Effect*

## Animate ON Effect

Animates on the selected effect. It can also be used to animate on a whole effect group in **Live** mode. It takes no parameters, but requires the effect to have been selected first.

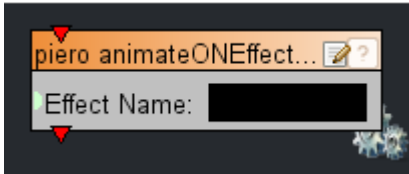

*DashBoard - PIERO AnimateONEffect*

## Animate OFF Effect

Animates off the selected effect. It can also be used to animate off a whole effect group in **Live** mode. It doesn't take any parameters, but it requires the effect to have been selected first.

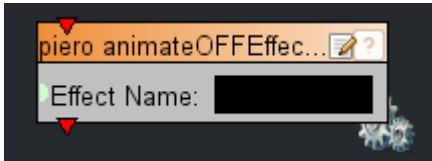



*DashBoard - PIERO AnimateOFFEffect*

# Appendix A: Troubleshooting

This section lists the most common issues you may experience when using PIERO. It is assumed that PIERO has been configured according to the instructions provided in PIERO Setup.

Issue	Solution
The desktop is not displayed correctly.	The monitor may not be plugged into the first nVidia HDMI/DO port. Try swapping the HDMI/DP ports. Then log out and log in again. <b>Ctrl + Alt + Backspace</b> forces screen-detection on the login page.
PIERO doesn't start from the launcher.	Ensure the PIERO license USB dongle is plugged into a USB port of the PIERO PC.  The dongle should glow red when connected.  The launcher will then display how many days remain on the license, indicating the license is valid and PIERO can now be launched.
No input video signal is shown in PIERO.	This could be due to incorrect video wiring. Refer to <a href="#">Hardware Setup</a> to check the PIERO video connections.  Also check that PIERO has been launched with the correct video mode with respect to the input video signal (e.g., PIERO will not show an HD video signal when launched in SD mode and vice versa).
No composite video signal is available.	The composite video signal of the PIERO PC only works in SD modes. There will be no composite output when PIERO is running in HD mode.
Video signal is jerky when sound is turned on.	When turning on sound, ensure that at least one audio channel is embedded in the input SDI signal (AiV). The DVS driver needs audio to be embedded in the SDI stream when PIERO runs with the sound option activated.
The VTR remote control doesn't work.	Check that the supplied 422 remote cable (with amplifier) is plugged in correctly. Using alternative cables may result in intermittent behavior.  Check that the 232 end is plugged into COM port 1 of the PIERO PC (on the motherboard).  Check that the <b>VTR</b> machine configuration is set up to be accessed remotely: <ul style="list-style-type: none"><li>• The <b>VTR</b> machine is set to use <b>Remote 9PIN</b> (on the Sony DVCAM 1500, this can be set using menu option <b>214</b>).</li><li>• Ensure the VTR remote port is configured for 422 and not 232 (e.g., the Sony XDCAM has an external switch on the rear that configures this port).</li><li>• The <b>Counter</b> should be set to <b>TC</b> (not <b>COUNTER</b>). On the Sony DVCAM 1500, this is changeable by selecting the <b>Counter Select</b> button.</li></ul>

Issue	Solution
The +/- Frame/Second VTR buttons don't work.	<p>The <b>Counter</b> should be set to <b>TC</b> (not <b>COUNTER</b>). On the Sony DVCAM 1500, this is changeable by selecting the <b>Counter Select</b> button.</p> <p>When using a Grass Valley Turbo iDDR device, ensure the clip bin used is the default bin and each clip timecode begins at <b>00:00:00:00</b>.</p>
The VTR effect doesn't pause on the correct timecode.	<p>If the video device stops before the pause, then jumps to the correct timecode, causing jitter in the video, reduce the <b>Response Time</b> in the <b>VTR</b> effect property sheet.</p> <p>See <a href="#">Calculating the Correct Response Time</a>  for details.</p> <p>If the video device stops too late causing the timebar line to appear after the pause duration and not traverse through the red pause area, increase the <b>Response Time</b> in the <b>VTR</b> effect property sheet.</p> <p>See <a href="#">Calculating the Correct Response Time</a>  for details.</p>
The VTR response time changes throughout the game.	Patch panels can introduce variable delays. We strongly recommend avoiding the use of a patch panel to wire the 422 remote cable. Operators may start reporting response time problems.
The Line Finding calibration will not fit onto the real pitch.	<p>Check that the pitch width and length measurements are correct on the <b>Calibration</b> property sheet.</p> <p>If this does not help, restart the process with a new calibration and carefully follow the correct sequence of operations for aligning the calibration as explained in the <i>PIERO User Guide</i>.</p> <p>Remember that a poorly distinguished white line on the pitch will make it harder to secure a quick calibration.</p>
The calibration doesn't lock back into place when a clip is replayed.	Ensure that the <b>Set In</b> button has been pressed after the <b>Auto</b> button when the calibration has been done.
Graphical effects not appearing or are badly drawn.	If the chromakeyer is not set-up correctly then the graphics will only be drawn partially or not at all.
Can't see the players in the virtual stadium.	<p>The <b>RGB Keyer</b> may need to be configured.</p> <p>However, it is possible that the players are in positions in which they are not being picked out by the <b>RGB Keyer</b> (e.g., over white lines or in-front of the crowd). If this appears to be the case then the <b>Region Tool</b> should be used to cut and draw regions around the players.</p>
Jogging the wheel on the LSM seems to cause the graphics to shift dramatically.	Check that the LSM has <b>Interpolation Validation</b> set to zero. A trained LSM operator will be able to do this.
Effects seem to drift after having left the virtual stadium.	If virtual cameras are being used in the virtual stadium, ensure that they are all timed to de-activate when no longer required. Otherwise the graphics will appear in the wrong place.

Issue	Solution
Timecode is erratic.	<p>Check that the small timecode switch (to the right of the timecode on the interface) is switched to the correct position, i.e., <b>LTC</b>, <b>VITC</b>, <b>DLTC</b> or <b>DVITC</b>.</p> <p><b>VITC</b> and <b>DVITC</b> are the preferred options.</p>
The interface stops responding and the video image freezes.	<p>Quit PIERO and restart. If you can't quit PIERO in the usual manner, follow the procedure below.</p> <p><b>To force quit PIERO:</b></p> <ol style="list-style-type: none"> <li>1. Press <b>Ctrl + Esc</b>.</li> <li>2. In the <b>Process Table</b> dialog, type <code>java</code> in the search bar.</li> <li>3. Close the java process that uses the highest percentage of system resources.</li> <li>4. Re-launch PIERO.</li> </ol>
The timecode display is red.	<p>This indicates that PIERO's video output is free-running, which is usually caused by the incorrect reference being supplied or the reference being disconnected completely.</p> <p>Check that the correct reference signal is supplied for the selected video mode. If the problem persists contact <a href="mailto:techsupport@rossvideo.com">techsupport@rossvideo.com</a>.</p> <p>The timecode often appears red for a few seconds when PIERO is first started – this does not indicate a problem as the hardware requires a short time to lock to the reference signal.</p> <p>Usually Black Burst is used in SD and Tri-Level is used to sync HD.</p>
The timecode display is yellow.	<p>This indicates that the user has launched PIERO with an internal timing reference selected. PIERO will not be locked to any external reference signal in this mode.</p> <p>To lock PIERO to a reference signal, select the relevant reference source on the PIERO launcher menu.</p>
The calibration jitters or doesn't lock.	<p>Try to establish the correct pitch dimensions and recalibrate.</p> <p>Also ensure that you calibrate at both ends of the pitch to give PIERO the maximum information about the camera.</p> <p>When using it on <b>Rugby League</b> or <b>Rugby Union</b>, it is critical to get the <b>In Goal Length</b> property right (even if you have to guess it). Failing to do so will cause the tracking to constantly look for a line in the wrong place introducing jittery artifacts.</p>
The PIERO UI isn't appearing correctly.	<p>The PIERO monitor video signal must be connected to the left-hand DVI port (when viewed from the back) of the graphics card.</p> <p>See <a href="#">Hardware Setup</a>  for more details.</p>

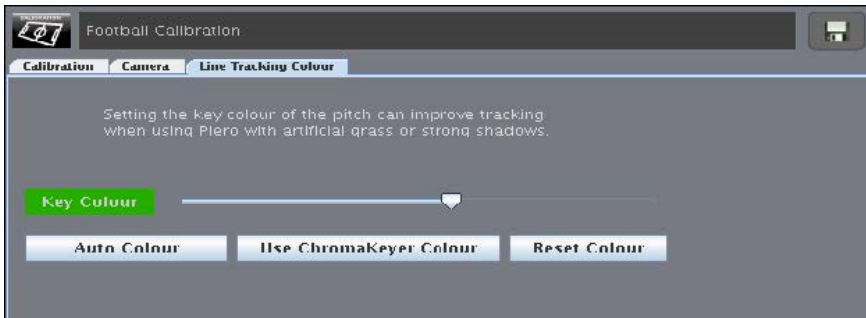
Issue	Solution
<p>The calibration doesn't track well.</p>	<p>This may be due to the internal chromakeyer used for finding lines on the pitch (white against green). You can check/adjust this key using the <b>Line Tracking Color</b> tab to automatically find the best key settings for your clip.</p>  <p>Pressing <b>Auto Colour</b> or <b>Use ChromaKeyer Colour</b> will attempt to alter the key to maximize the number of lines used for tracking.</p>
<p>Linux file manager crashes when opening folders.</p>	<p>We think the file manager (Konquerer) is having problems generating very large icons for files in a folder.</p> <p><b>To remove the settings:</b></p> <ol style="list-style-type: none"> <li>1. On the PIERO system, start the <b>Terminal</b> program <p>The program usually lives in the fedora menu (blue 'f', in the bar along the bottom of screen), then <b>System &gt; Terminal</b>.</p> </li> <li>2. When the <b>Terminal</b> program is running, type <code>mv .kde/share/config/konqiconviewrc konqiconviewrcbad.</code></li> <li>3. Press <b>Enter</b>. <p>A new empty command prompt window should open.</p> </li> <li>4. Close the <b>Terminal</b> window <p>The file manager should work properly now.</p> <p>In future, please <b>DO NOT</b> select the <b>Enlarge Icon</b> the <b>+</b> magnify or use the large icon mode in the file manager.</p> </li> </ol>

# Calculating the Correct Response Time

The correct value for the Response Time property can be found by following this procedure:

## To calculate the correct Response Time:

1. Create a **VTR** effect at the desired timecode, for example 10:00:00:00.
2. In the property sheet, set the **Response Time** parameter temporarily to zero.
3. Set PIERO to **ON AIR** mode and play the video device to the **VTR** effect pause point.

You will notice the VTR will play past the desired timecode and will pause too late at something like 10:00:00:05. The five frames difference is the time for the video device to react to the **Pause** command, caused by delays inherent in the video device.

4. Calculate the **Response Time** as double this difference (in this example it is therefore 10).

It is double because the **Response Time** is measured in fields for fine control over this delay.

5. Enter the **Response Time** value into the PIERO **Settings > General Tab > VTR Response Time** field for later use.

Changing the PIERO timecode setting (e.g., from **DVITC** to **LTC**) can affect the **Response Time** value and so it may need to be recalculated.



## Contact Us

Contact our friendly and professional support representatives for the following:

- Name and address of your local dealer
- Product information and pricing
- Technical support
- Upcoming trade show information

<b>Technical Support</b>	<b>Telephone:</b>	+1-844-652-0645 (North America) +800 3540 3545 (International)
	<b>After Hours Emergency:</b>	+1 613 • 349 • 0006
	<b>Email:</b>	techsupport@rossvideo.com

<b>General Information</b>	<b>Telephone:</b>	+1 613 • 652 • 4886
	<b>Fax:</b>	+1 613 • 652 • 4425
	<b>Email:</b>	solutions@rossvideo.com
	<b>Website:</b>	<a href="http://www.rossvideo.com">http://www.rossvideo.com</a>

## Visit Us

Visit our website for:

- Company information and news
- Related products and full product lines
- Online catalog
- Testimonials